



REGIONE TOSCANA



CITTA' METROPOLITANA DI FIRENZE



COMUNE DI SCANDICCI

**STUDIO IDROLOGICO-IDRAULICO
A SUPPORTO DEL PIANO PARTICOLAREGGIATO
DELL'AREA DI TRASFORMAZIONE TR 04C**

CODICE:

A.02

ELABORATO:

**SEZIONI FLUVIALI VERIFICHE IDRAULICHE
STATO DI PROGETTO**

SCALA -



**West Systems s.r.l. divisione
PHYSIS - Ingegneria per l'ambiente**
Viale Donato Giannotti 24
- 50126 - FIRENZE
Tel. 055 4684253 / 055 461429
Fax. 055 6580564
Pec.: amministrazione@pec.westsystems.it

PROGETTISTA:

Ing. David Settesoldi

COLLABORATORI TECNICI:

Ing. Michele Catella
Geom. Daniele Natali

COMMITTENTE:

Comune di Scandicci
Piazzale della Resistenza
50018 - SCANDICCI

02					
01	SECONDA EMISSIONE	23/10/2019	Ing. Michele Catella	Ing. Michele Catella	Ing. David Settesoldi
00	PRIMA EMISSIONE	01/08/2019	Ing. Michele Catella	Ing. Michele Catella	Ing. David Settesoldi
REV.	DESCRIZIONE	DATA	REDATTO	VERIFICATO	APPROVATO
REVISIONE			DATA		
00			23/10/2019		

INDICE

Sezioni fluviali torrenti Greve-Vingone stato di progetto $Tr = 30$ anni	3
Sezioni fluviali torrenti Greve-Vingone stato di progetto $Tr = 200$ anni	109

**Sezioni fluviali
torrenti Greve-Vingone
stato di progetto
Tr = 30 anni**

Studio Scandicci Torrenti Greve-Vingone
River = Fosso Botteghino Reach = Botteghino RS = 19 SD0013_D

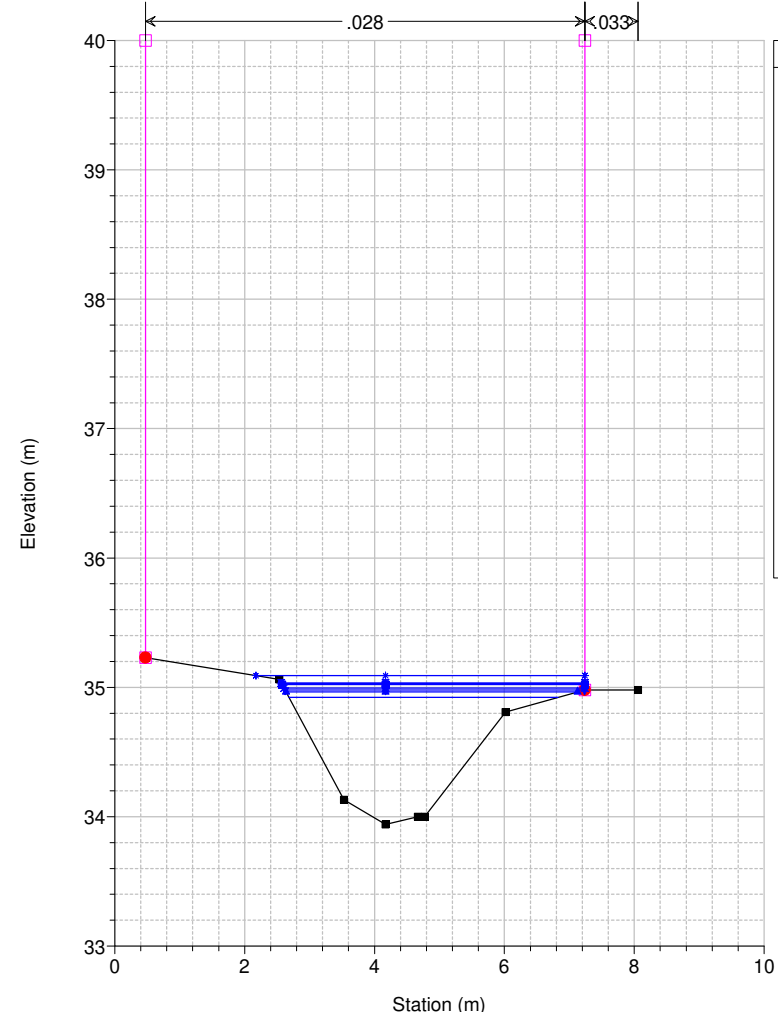

Legend

- WS Max WS - TR030_36_0
- WS Max WS - TR030_12_0
- WS Max WS - TR030_18_0
- WS Max WS - TR030_09_0
- WS Max WS - TR030_24_0
- WS Max WS - TR030_06_0
- WS Max WS - TR030_03_0
- WS Max WS - TR030_01_5
- WS Max WS - TR030_01_0
- WS Max WS - TR030_00_5
- Ground
- Levee
- Bank Sta

Studio Scandicci Torrenti Greve-Vingone
River = Fosso Botteghino Reach = Botteghino RS = 18 SD0012_

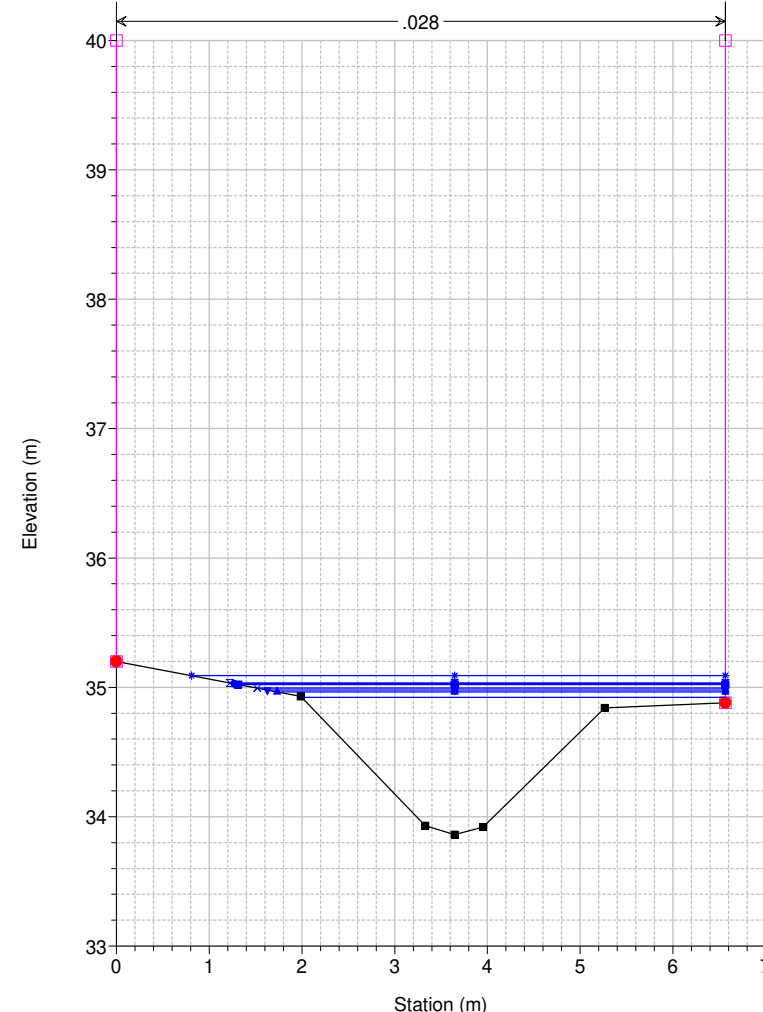

Legend

- WS Max WS - TR030_36_0
- WS Max WS - TR030_12_0
- WS Max WS - TR030_18_0
- WS Max WS - TR030_09_0
- WS Max WS - TR030_24_0
- WS Max WS - TR030_06_0
- WS Max WS - TR030_03_0
- WS Max WS - TR030_01_5
- WS Max WS - TR030_01_0
- WS Max WS - TR030_00_5
- Ground
- Levee
- Bank Sta

Studio Scandicci Torrenti Greve-Vingone
River = Fosso Botteghino Reach = Botteghino RS = 17 SD0011_

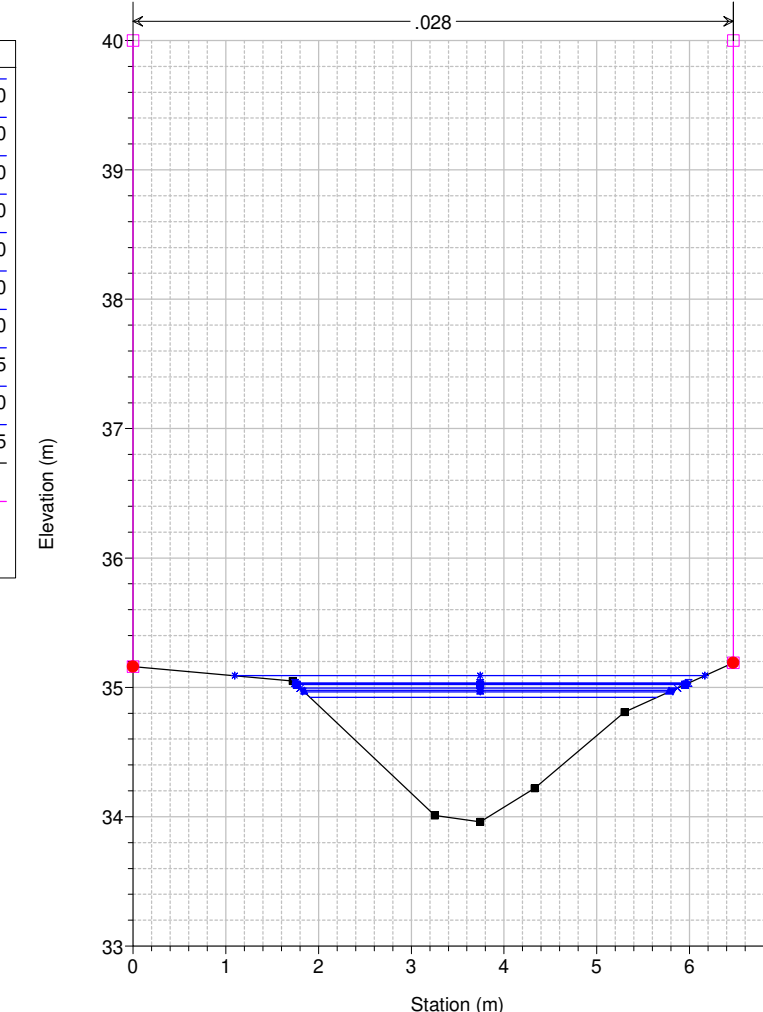

Legend

- WS Max WS - TR030_36_0
- WS Max WS - TR030_12_0
- WS Max WS - TR030_18_0
- WS Max WS - TR030_09_0
- WS Max WS - TR030_24_0
- WS Max WS - TR030_06_0
- WS Max WS - TR030_03_0
- WS Max WS - TR030_01_5
- WS Max WS - TR030_01_0
- WS Max WS - TR030_00_5
- Ground
- Levee
- Bank Sta

Studio Scandicci Torrenti Greve-Vingone
River = Fosso Botteghino Reach = Botteghino RS = 16 SD0010_

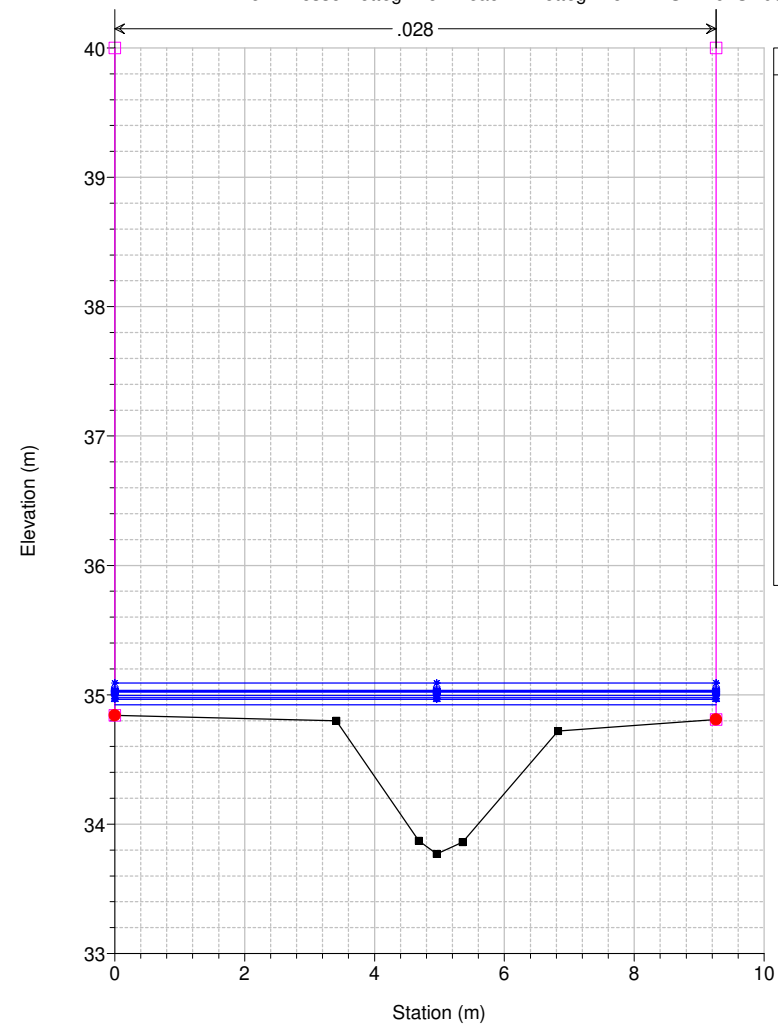

Legend

- WS Max WS - TR030_36_0
- WS Max WS - TR030_12_0
- WS Max WS - TR030_18_0
- WS Max WS - TR030_09_0
- WS Max WS - TR030_24_0
- WS Max WS - TR030_06_0
- WS Max WS - TR030_03_0
- WS Max WS - TR030_01_5
- WS Max WS - TR030_01_0
- WS Max WS - TR030_00_5
- Ground
- Levee
- Bank Sta

Studio Scandicci Torrenti Greve-Vingone
River = Fosso Botteghino Reach = Botteghino RS = 15 SD0009_

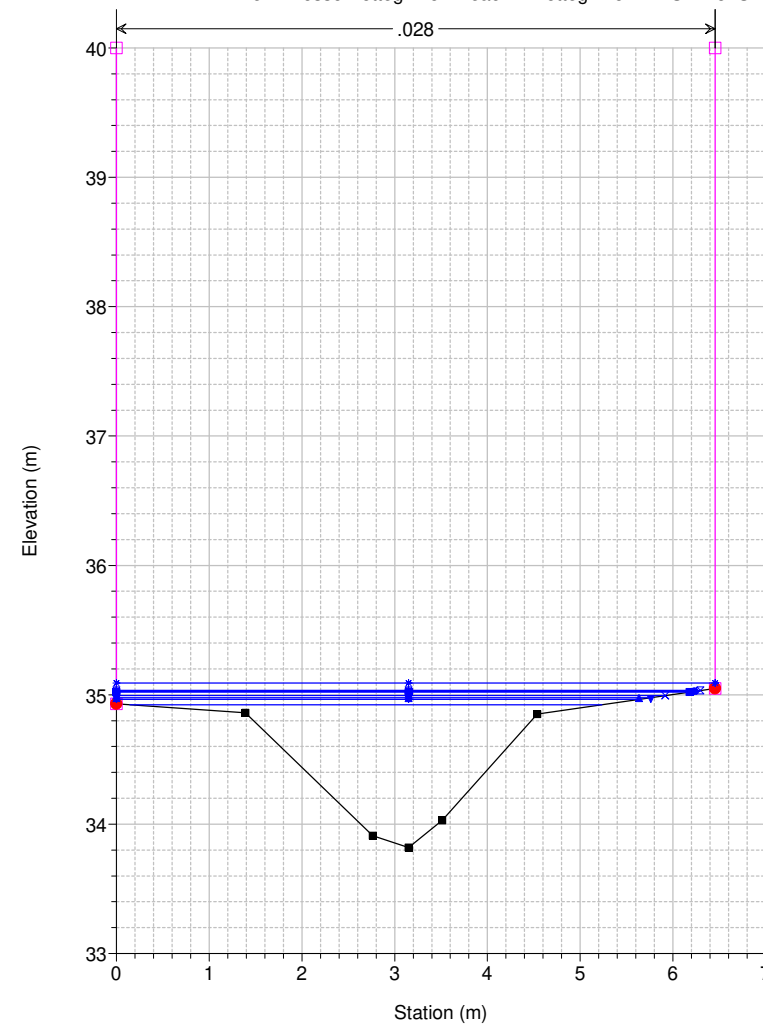

Legend

- WS Max WS - TR030_36_0
- WS Max WS - TR030_12_0
- WS Max WS - TR030_18_0
- WS Max WS - TR030_09_0
- WS Max WS - TR030_24_0
- WS Max WS - TR030_06_0
- WS Max WS - TR030_03_0
- WS Max WS - TR030_01_5
- WS Max WS - TR030_01_0
- WS Max WS - TR030_00_5
- Ground
- Levee
- Bank Sta

Studio Scandicci Torrenti Greve-Vingone
River = Fosso Botteghino Reach = Botteghino RS = 14 SD0008_

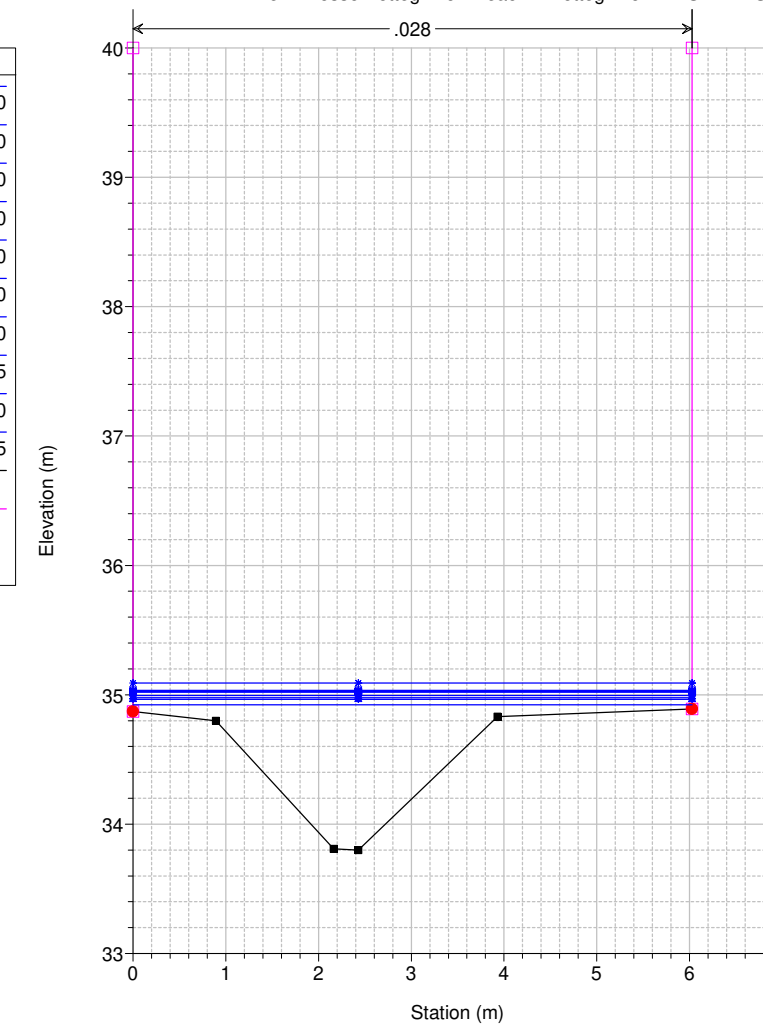

Legend

- WS Max WS - TR030_36_0
- WS Max WS - TR030_12_0
- WS Max WS - TR030_18_0
- WS Max WS - TR030_09_0
- WS Max WS - TR030_24_0
- WS Max WS - TR030_06_0
- WS Max WS - TR030_03_0
- WS Max WS - TR030_01_5
- WS Max WS - TR030_01_0
- WS Max WS - TR030_00_5
- Ground
- Levee
- Bank Sta

Studio Scandicci Torrenti Greve-Vingone
River = Fosso Botteghino Reach = Botteghino RS = 13 SD0007_

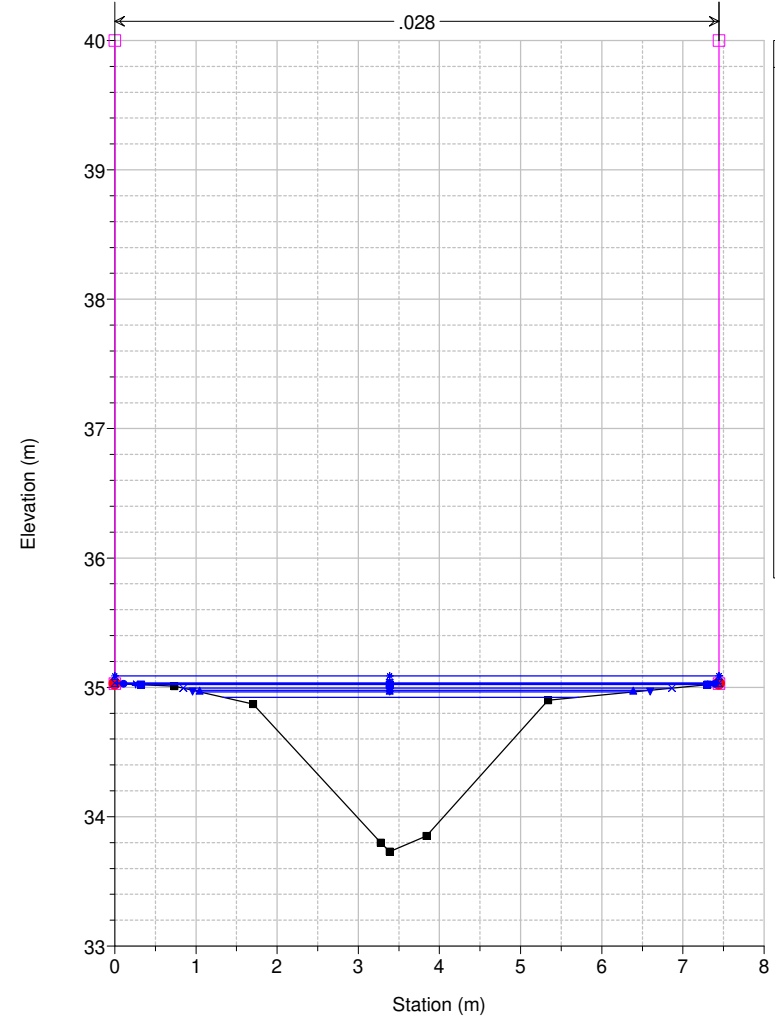

Legend	
WS Max WS - TR030_36_0	▲
WS Max WS - TR030_12_0	✕
WS Max WS - TR030_18_0	+
WS Max WS - TR030_09_0	●
WS Max WS - TR030_24_0	■
WS Max WS - TR030_06_0	■
WS Max WS - TR030_03_0	✕
WS Max WS - TR030_01_5	▼
WS Max WS - TR030_01_0	▲
WS Max WS - TR030_00_5	■
Ground	■
Levee	□
Bank Sta	●

Studio Scandicci Torrenti Greve-Vingone
River = Fosso Botteghino Reach = Botteghino RS = 12 SD0006_A

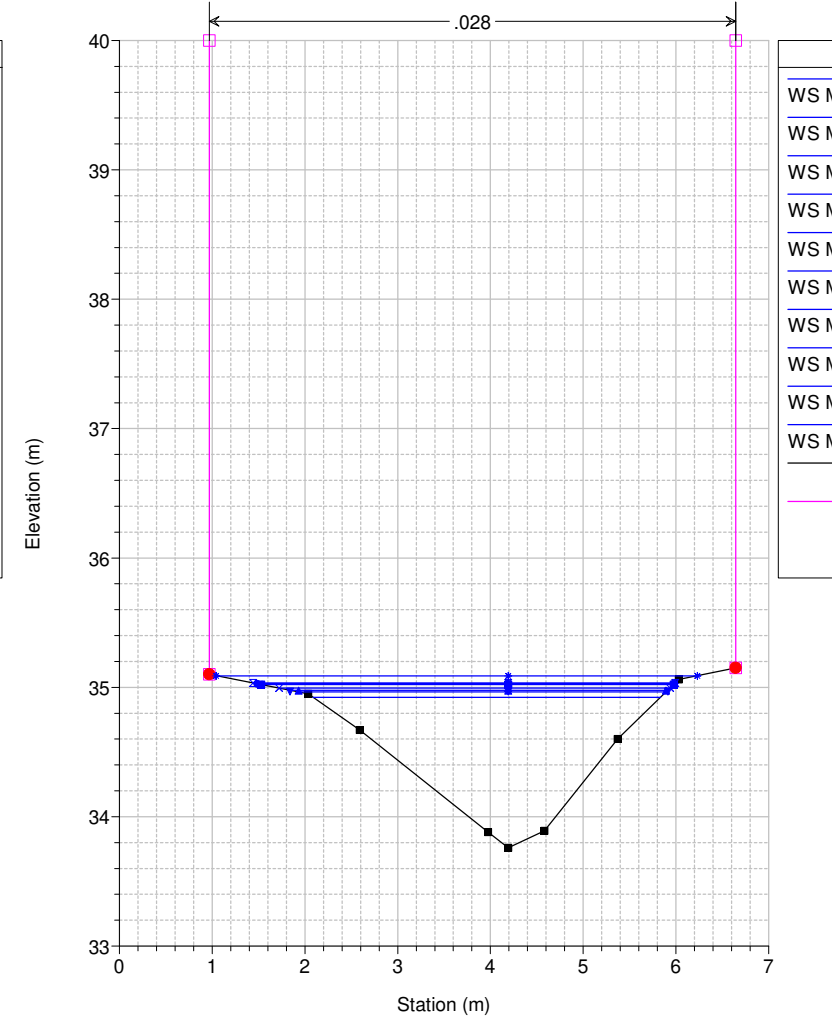

Legend	
WS Max WS - TR030_36_0	▲
WS Max WS - TR030_12_0	✕
WS Max WS - TR030_18_0	+
WS Max WS - TR030_09_0	●
WS Max WS - TR030_24_0	■
WS Max WS - TR030_06_0	■
WS Max WS - TR030_03_0	✕
WS Max WS - TR030_01_5	▼
WS Max WS - TR030_01_0	▲
WS Max WS - TR030_00_5	■
Ground	■
Levee	□
Bank Sta	●

Studio Scandicci Torrenti Greve-Vingone
River = Fosso Botteghino Reach = Botteghino RS = 11 SD0006_B

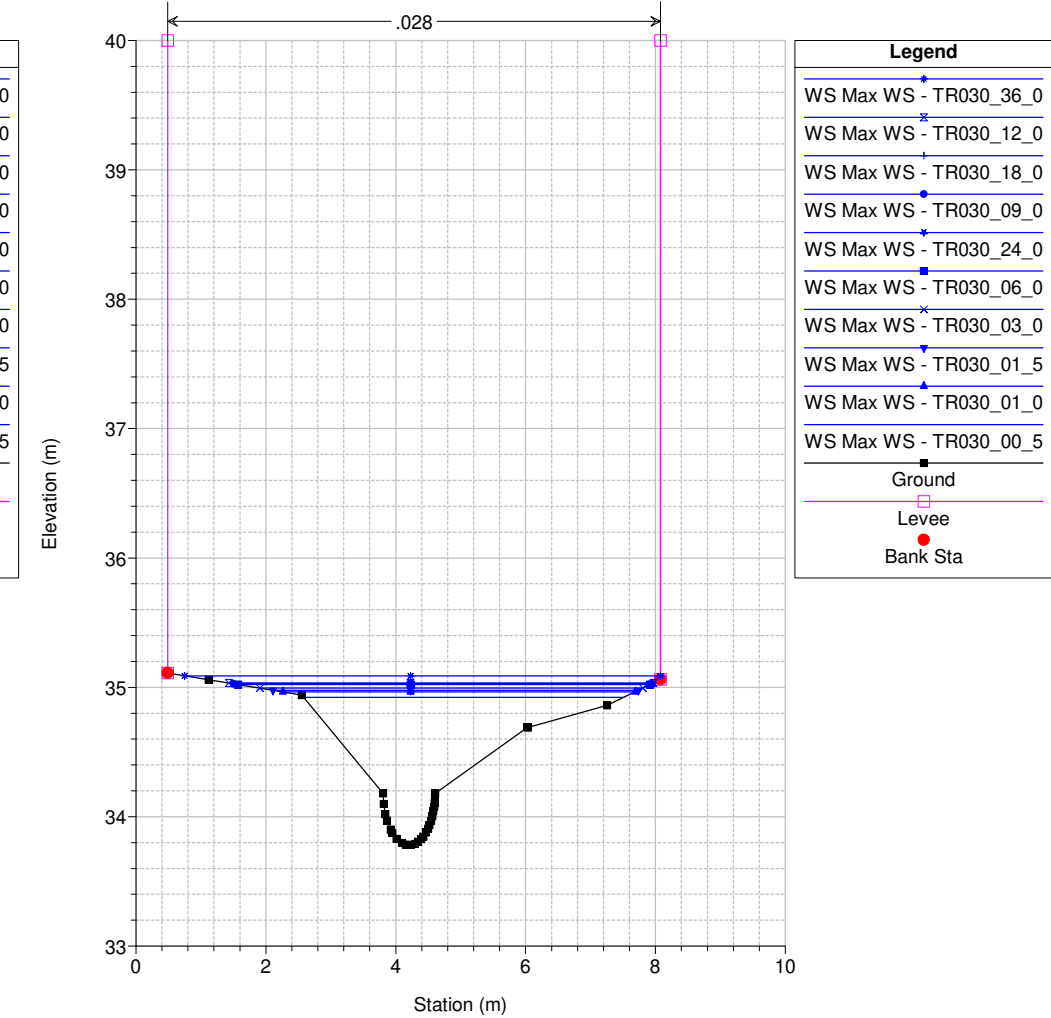

Legend	
WS Max WS - TR030_36_0	▲
WS Max WS - TR030_12_0	✕
WS Max WS - TR030_18_0	+
WS Max WS - TR030_09_0	●
WS Max WS - TR030_24_0	■
WS Max WS - TR030_06_0	■
WS Max WS - TR030_03_0	✕
WS Max WS - TR030_01_5	▼
WS Max WS - TR030_01_0	▲
WS Max WS - TR030_00_5	■
Ground	■
Levee	□
Bank Sta	●

Studio Scandicci Torrenti Greve-Vingone
River = Fosso Botteghino Reach = Botteghino RS = 10.5 BR

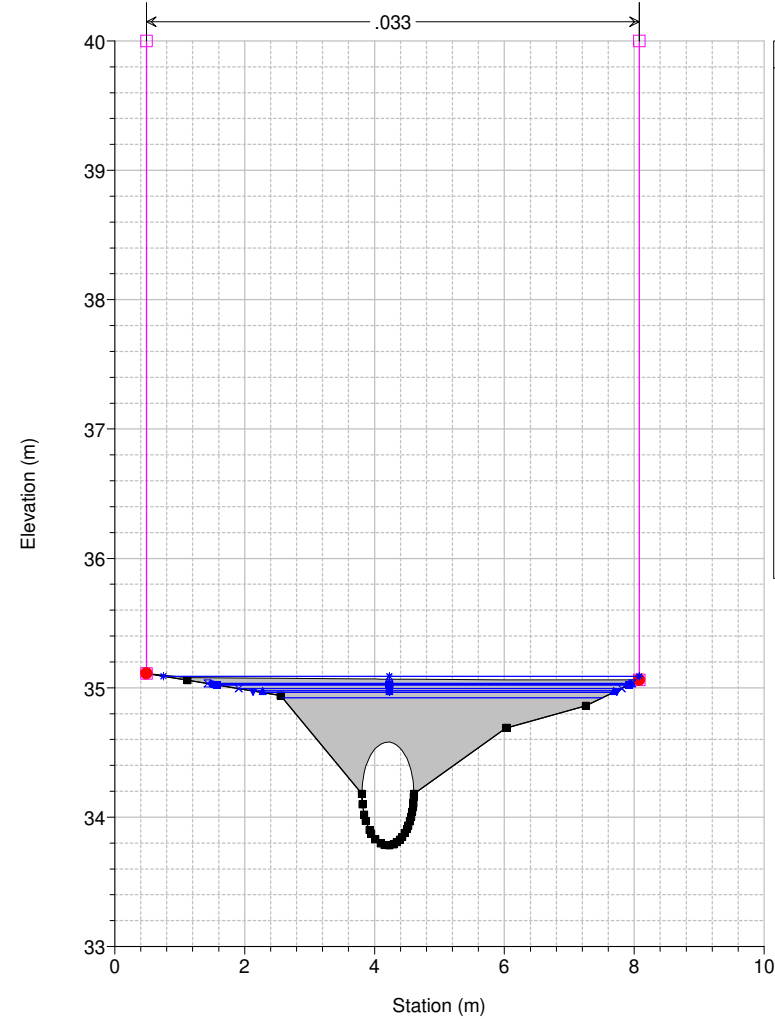

Legend	
WS Max WS - TR030_36_0	▲
WS Max WS - TR030_12_0	✕
WS Max WS - TR030_18_0	+
WS Max WS - TR030_09_0	●
WS Max WS - TR030_24_0	■
WS Max WS - TR030_06_0	■
WS Max WS - TR030_03_0	✕
WS Max WS - TR030_01_5	▼
WS Max WS - TR030_01_0	▲
WS Max WS - TR030_00_5	■
Ground	■
Levee	□
Bank Sta	●

Studio Scandicci Torrenti Greve-Vingone
River = Fosso Botteghino Reach = Botteghino RS = 10.5 BR

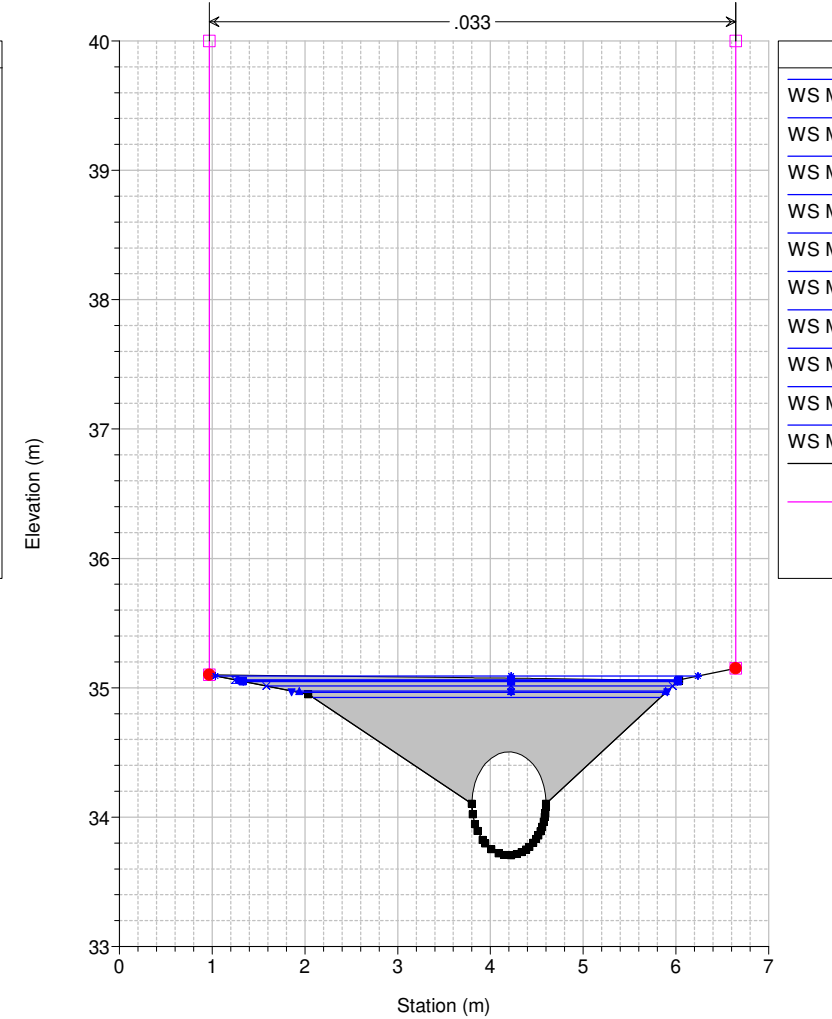

Legend	
WS Max WS - TR030_36_0	▲
WS Max WS - TR030_12_0	✕
WS Max WS - TR030_18_0	+
WS Max WS - TR030_09_0	●
WS Max WS - TR030_24_0	■
WS Max WS - TR030_06_0	■
WS Max WS - TR030_03_0	✕
WS Max WS - TR030_01_5	▼
WS Max WS - TR030_01_0	▲
WS Max WS - TR030_00_5	■
Ground	■
Levee	□
Bank Sta	●

Studio Scandicci Torrenti Greve-Vingone
River = Fosso Botteghino Reach = Botteghino RS = 10 SD0006_C

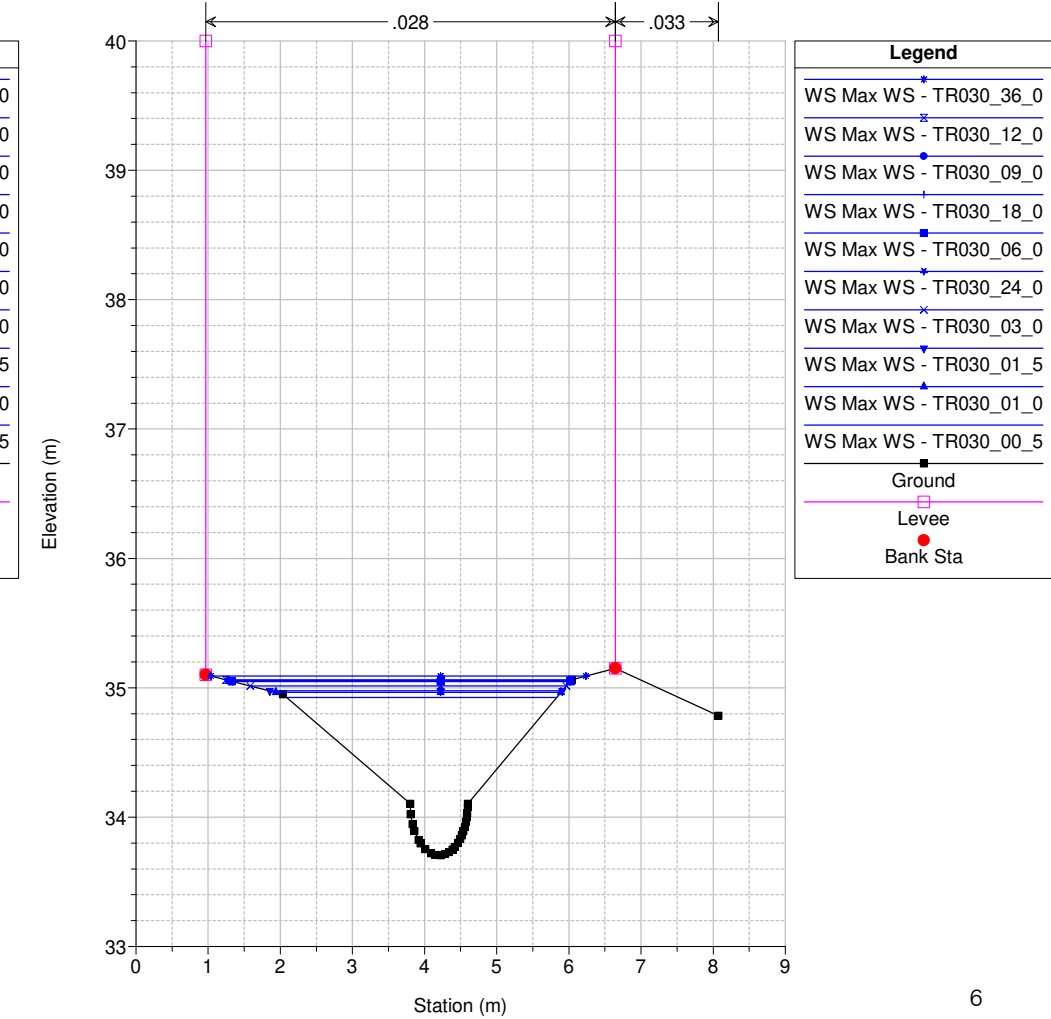

Legend	
WS Max WS - TR030_36_0	▲
WS Max WS - TR030_12_0	✕
WS Max WS - TR030_18_0	+
WS Max WS - TR030_09_0	●
WS Max WS - TR030_24_0	■
WS Max WS - TR030_06_0	■
WS Max WS - TR030_03_0	✕
WS Max WS - TR030_01_5	▼
WS Max WS - TR030_01_0	▲
WS Max WS - TR030_00_5	■
Ground	■
Levee	□
Bank Sta	●

Studio Scandicci Torrenti Greve-Vingone
River = Fosso Botteghino Reach = Botteghino RS = 9 SD0006_D

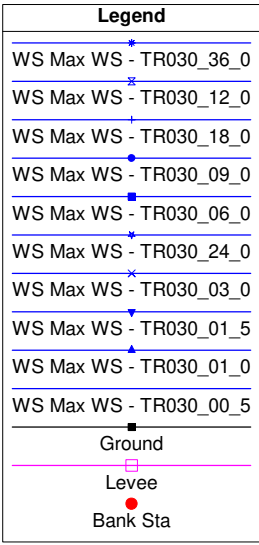
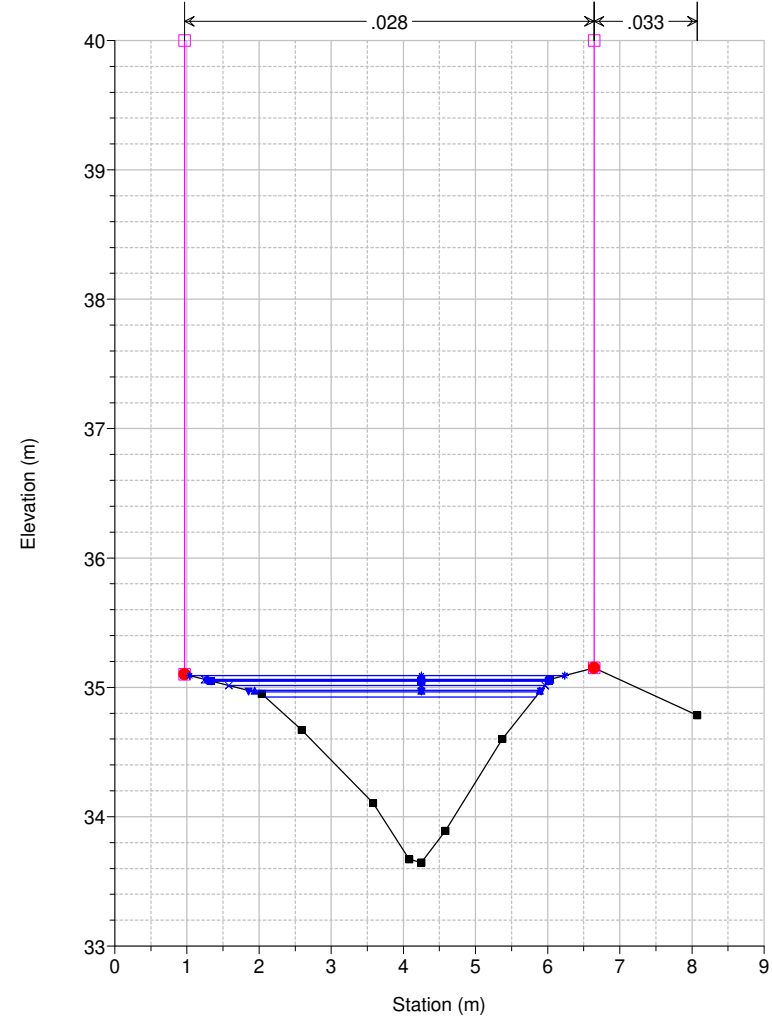

Studio Scandicci Torrenti Greve-Vingone
River = Fosso Botteghino Reach = Botteghino RS = 8 SD0005_

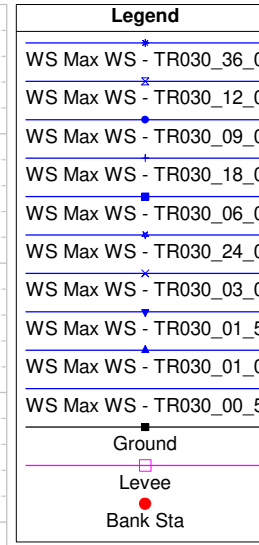
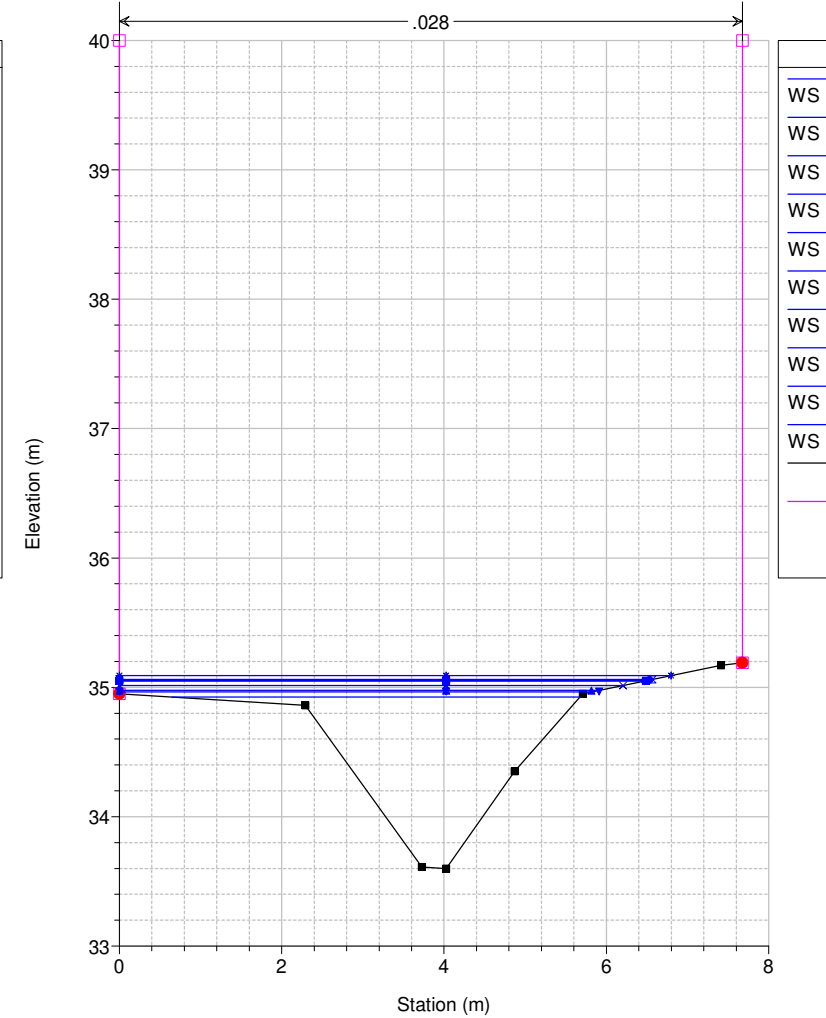

Studio Scandicci Torrenti Greve-Vingone
River = Fosso Botteghino Reach = Botteghino RS = 7 SD0004_

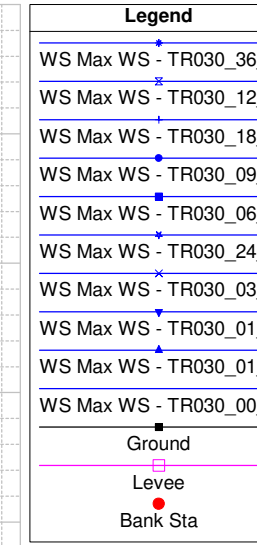
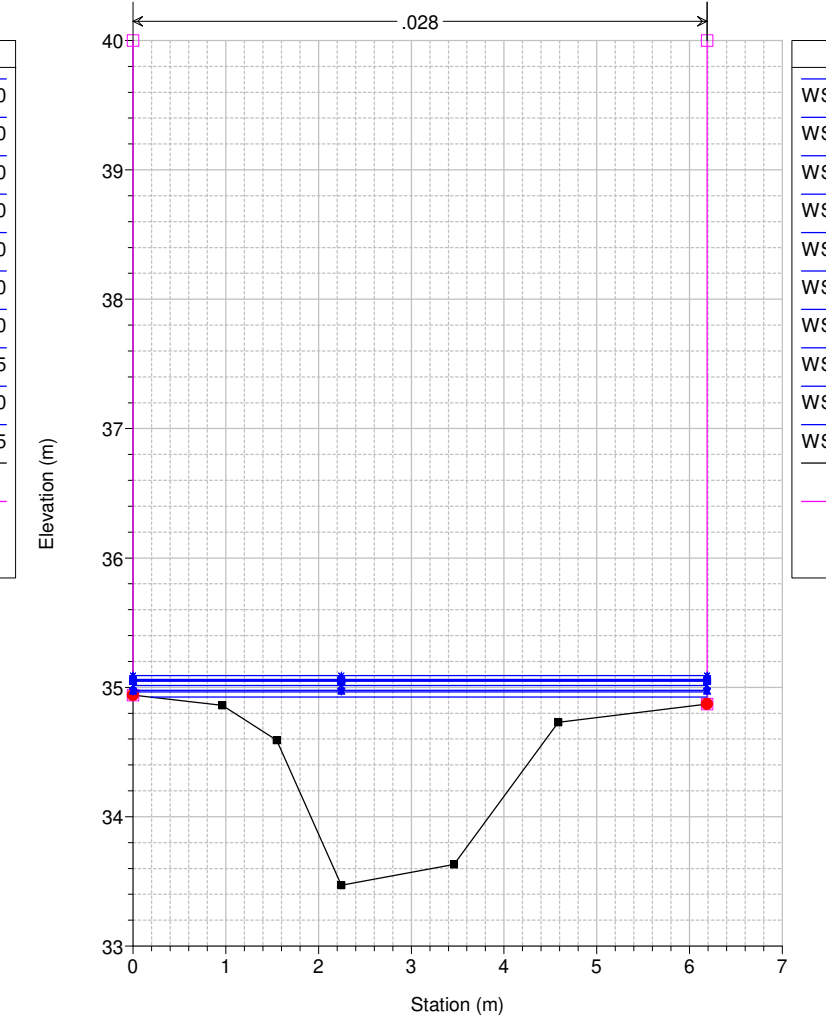

Studio Scandicci Torrenti Greve-Vingone
River = Fosso Botteghino Reach = Botteghino RS = 6 SD0003_

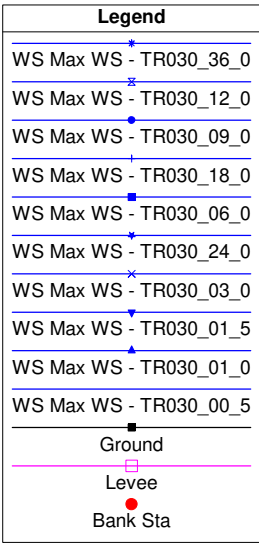
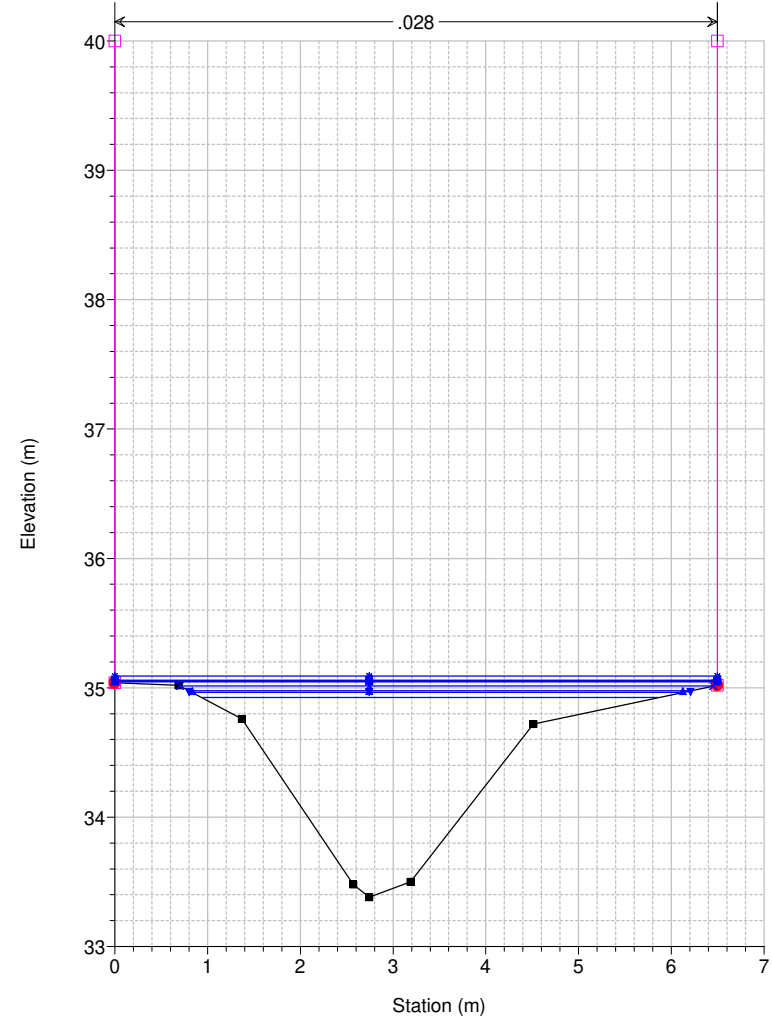

Studio Scandicci Torrenti Greve-Vingone
River = Fosso Botteghino Reach = Botteghino RS = 5 SD0002_

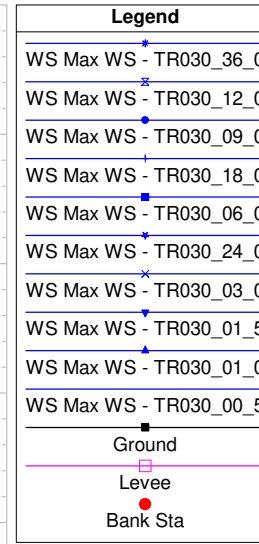
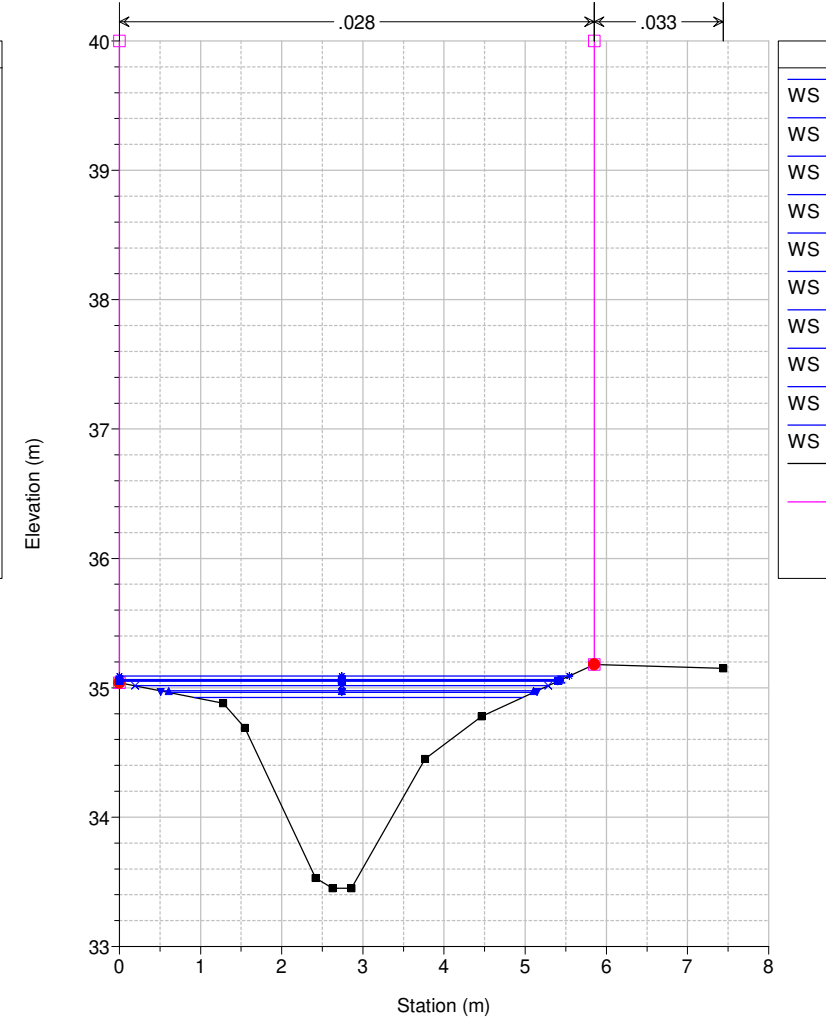

Studio Scandicci Torrenti Greve-Vingone
River = Fosso Botteghino Reach = Botteghino RS = 4 SD0001_A

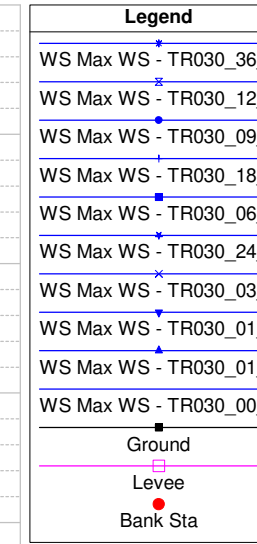
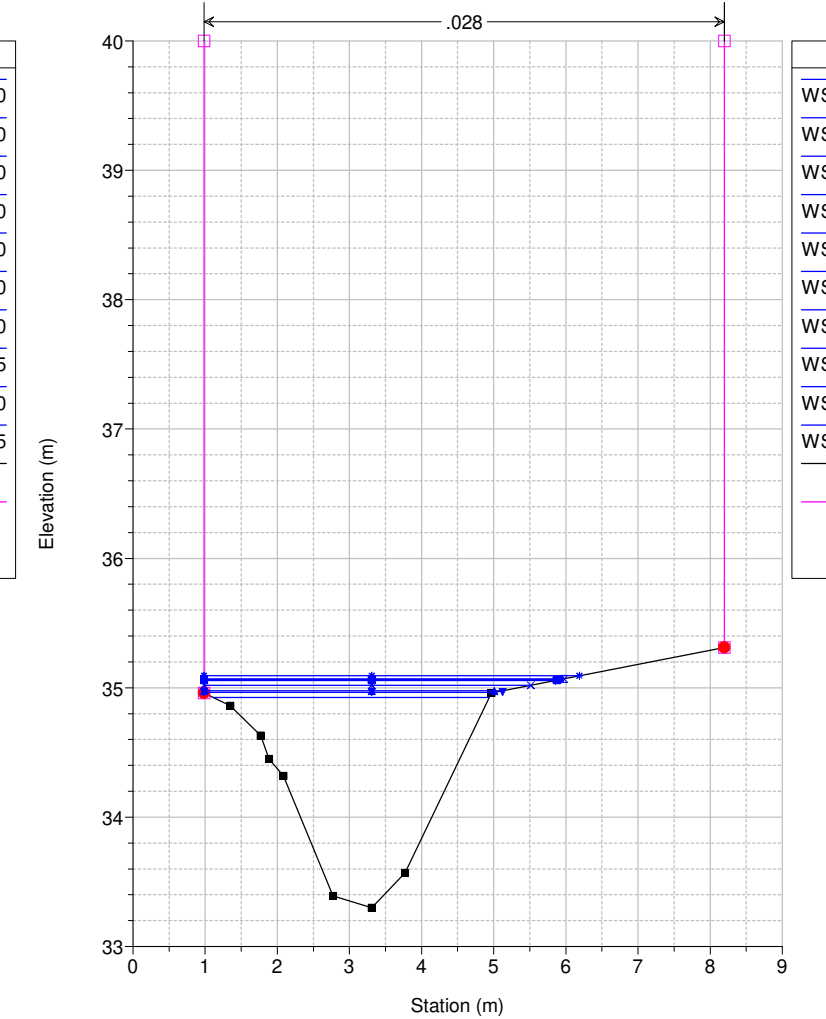

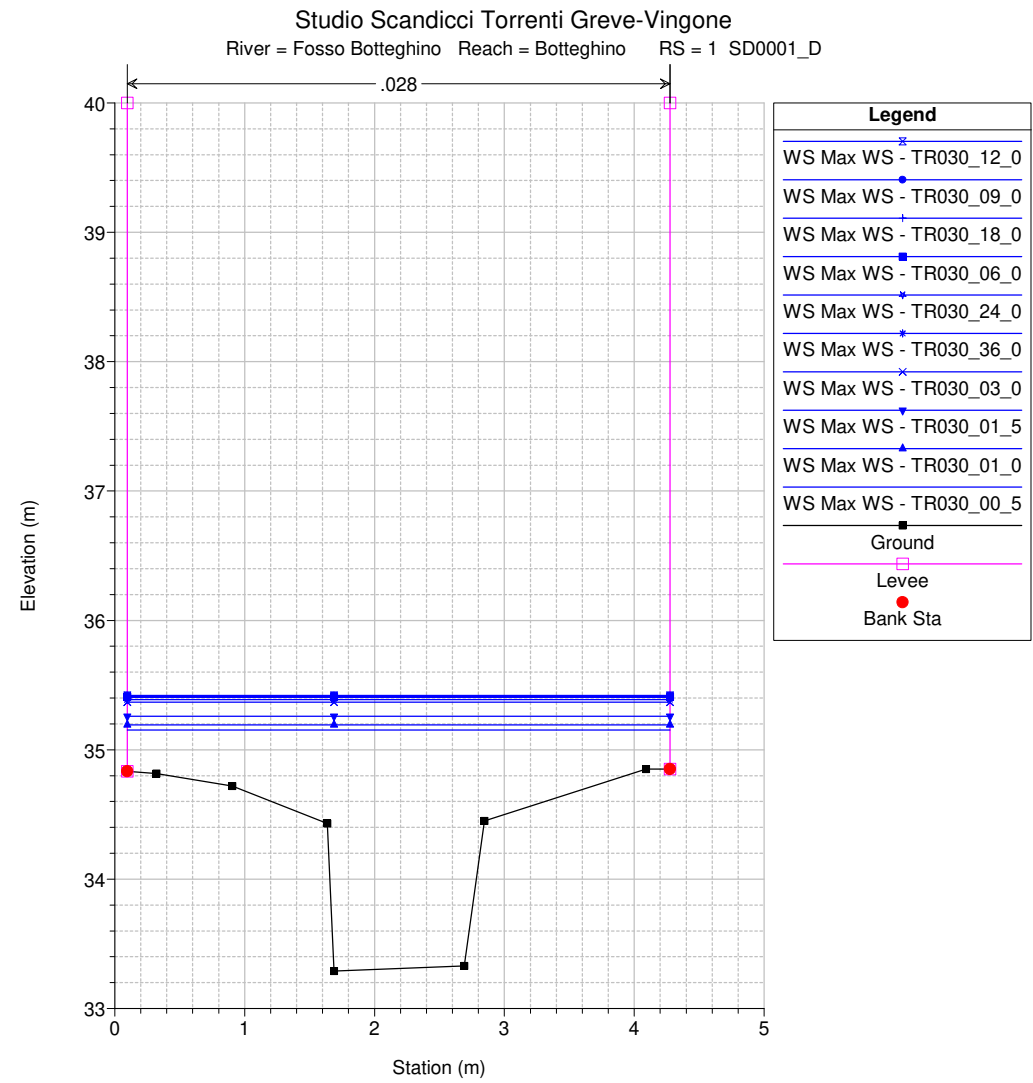
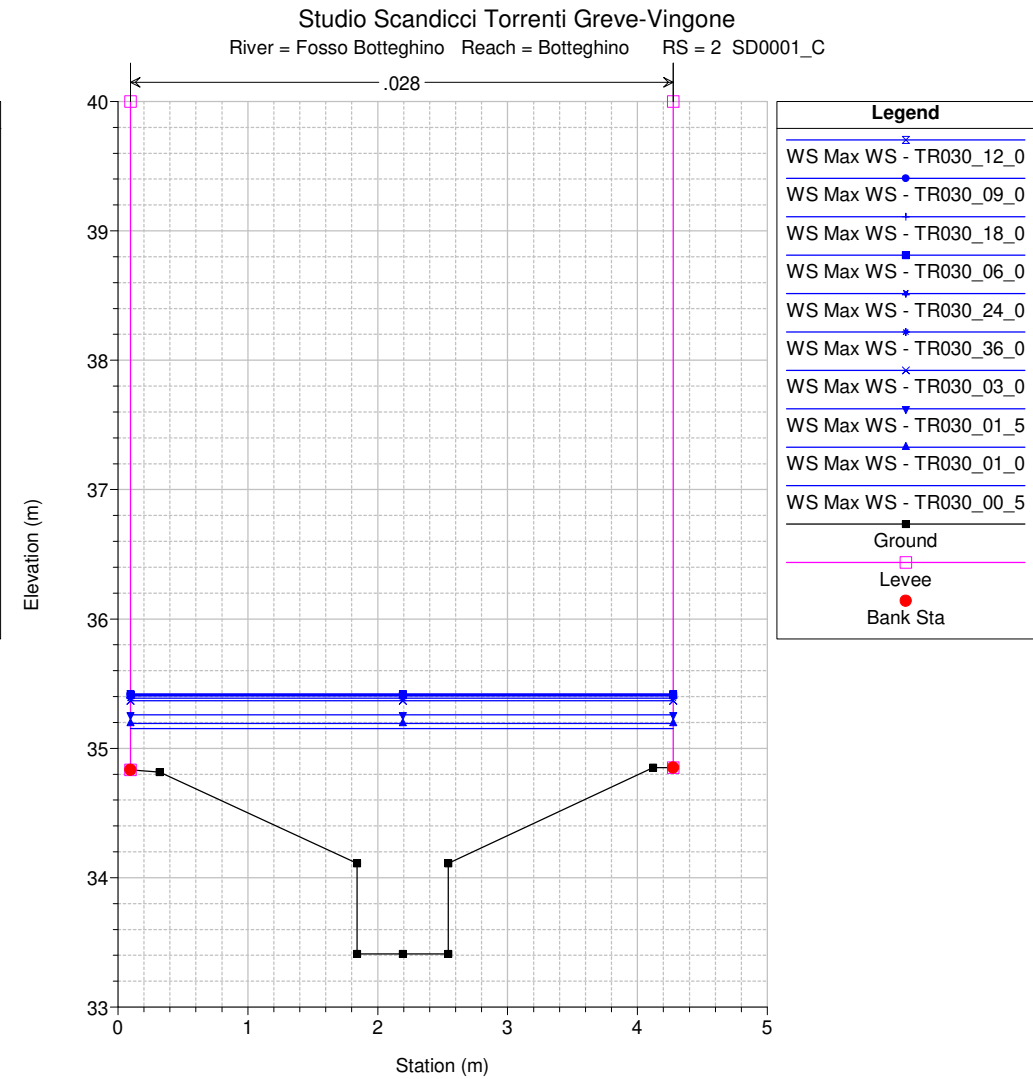
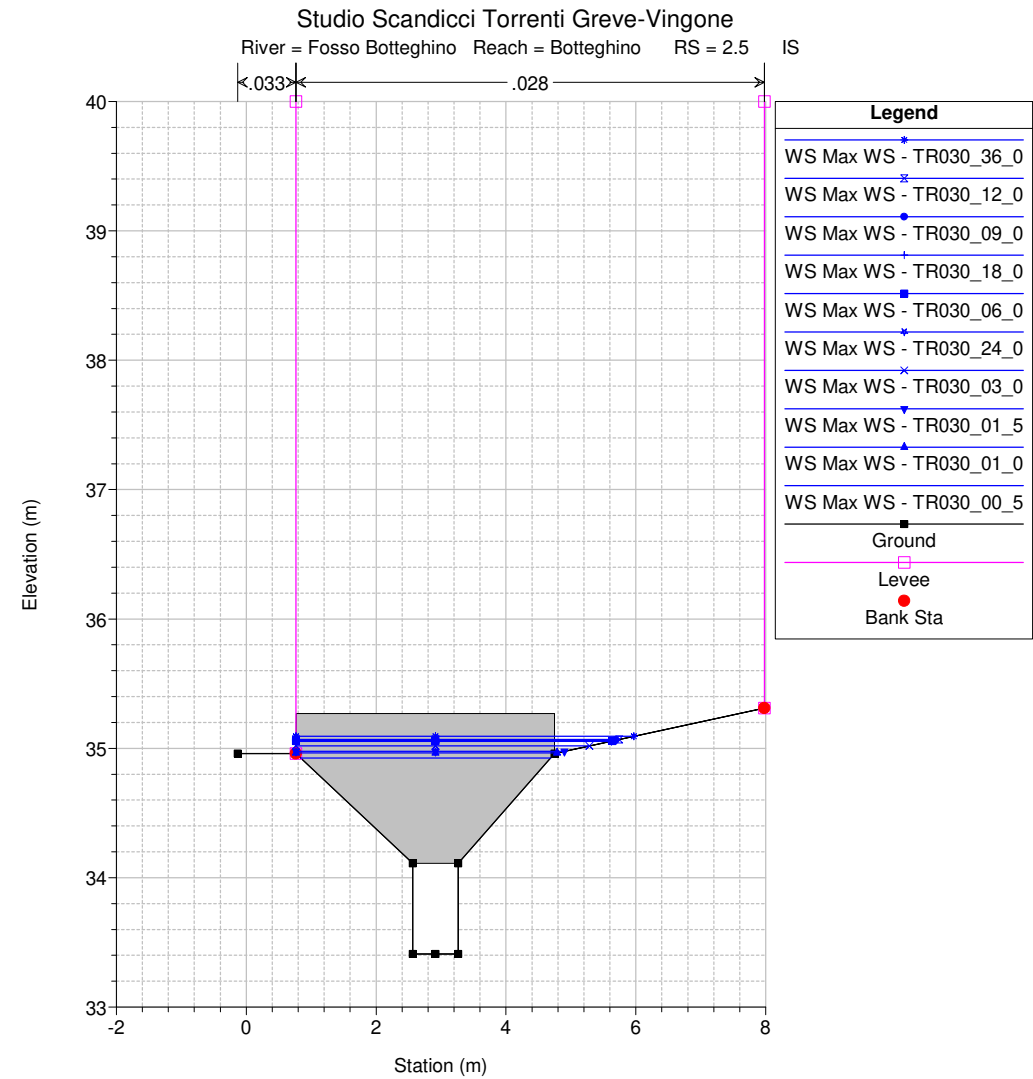
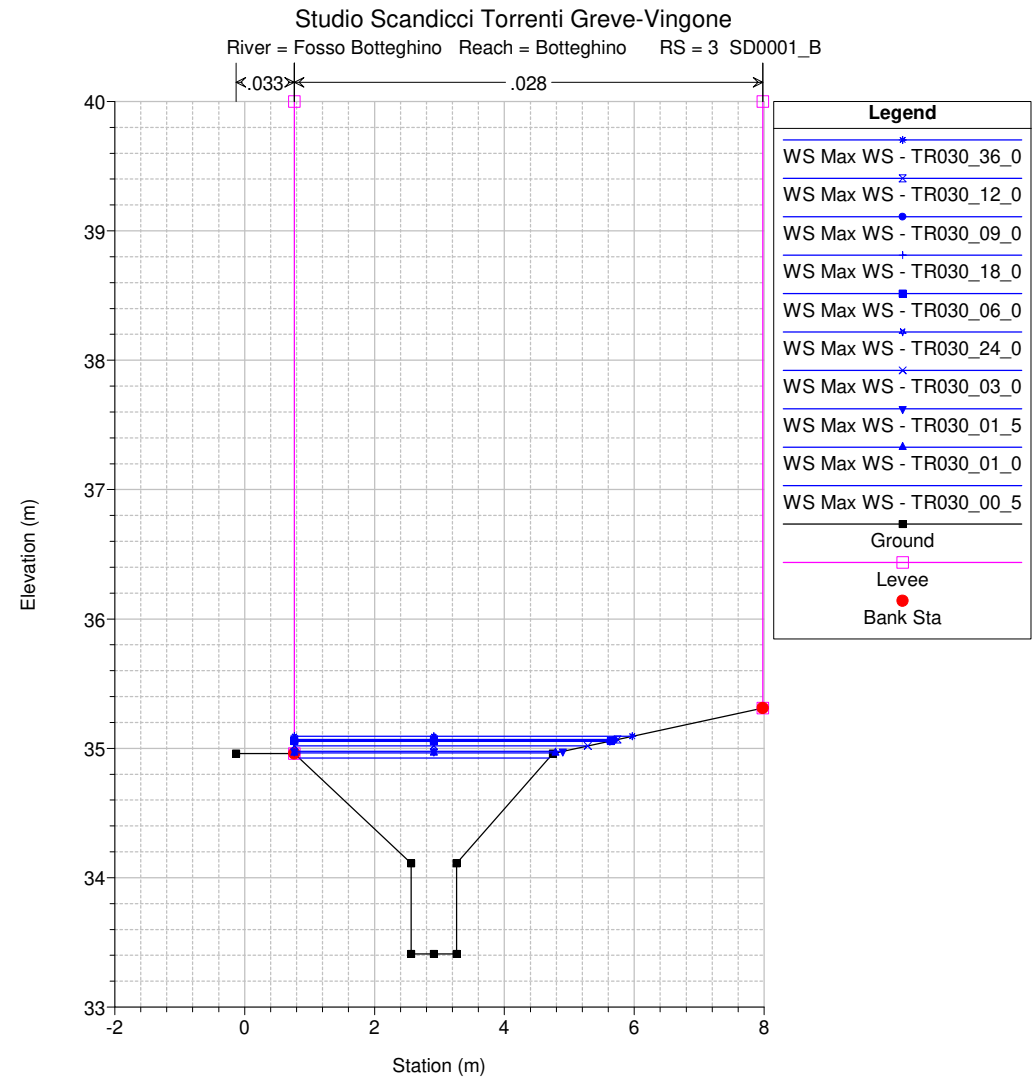

Studio Scandicci Torrenti Greve-Vingone
River = Fosso Dogaia Reach = Dogaia_02 RS = 48 DO1013_D

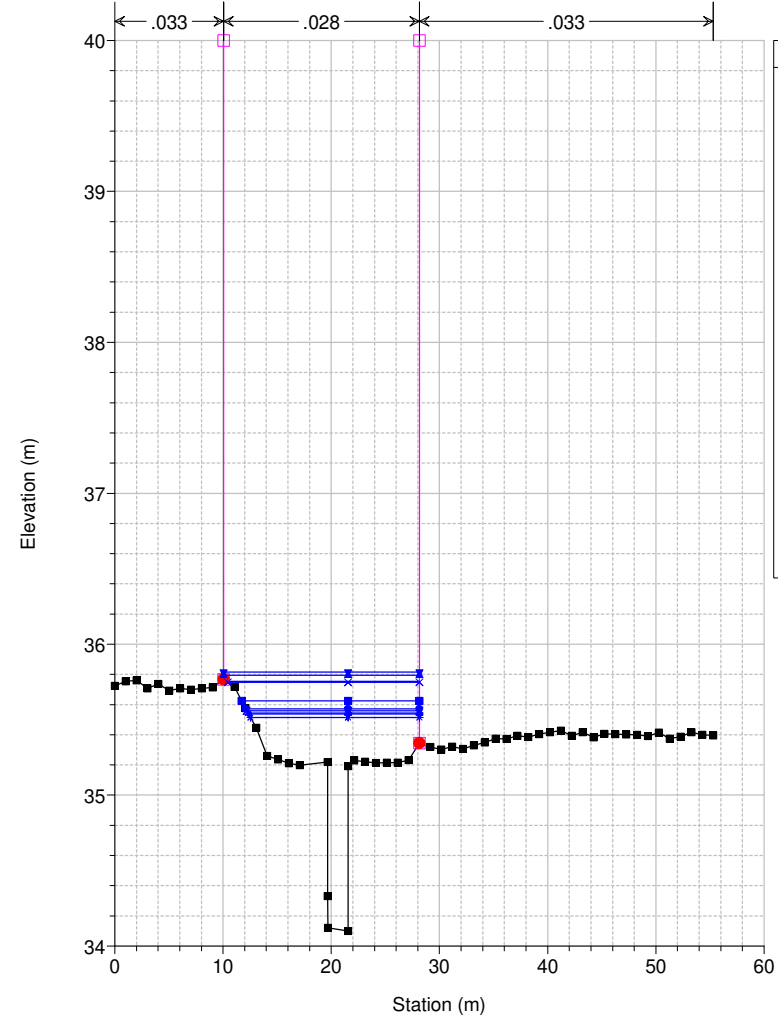

Legend	
WS Max WS - TR030_01_5	▲
WS Max WS - TR030_01_0	▲
WS Max WS - TR030_00_5	×
WS Max WS - TR030_03_0	■
WS Max WS - TR030_06_0	●
WS Max WS - TR030_09_0	●
WS Max WS - TR030_12_0	×
WS Max WS - TR030_18_0	▲
WS Max WS - TR030_24_0	▲
WS Max WS - TR030_36_0	▲
Ground	■
Levee	□
Bank Sta	●

Studio Scandicci Torrenti Greve-Vingone
River = Fosso Dogaia Reach = Dogaia_02 RS = 47 DO1014_A

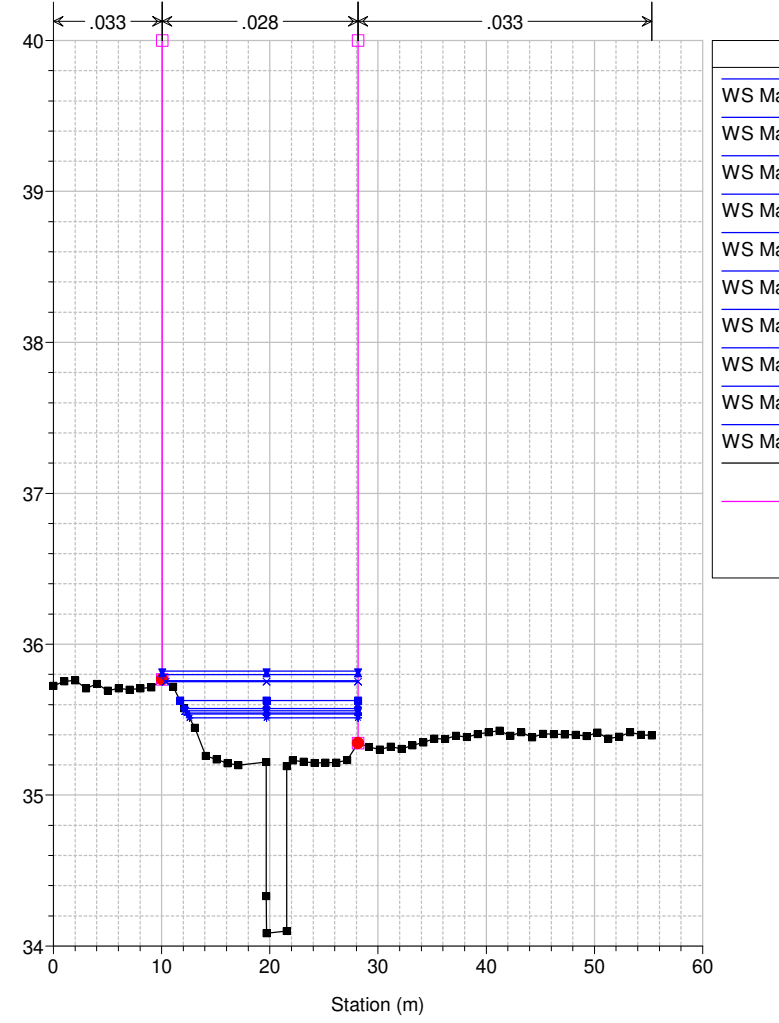

Legend	
WS Max WS - TR030_01_5	▲
WS Max WS - TR030_01_0	▲
WS Max WS - TR030_00_5	×
WS Max WS - TR030_03_0	■
WS Max WS - TR030_06_0	●
WS Max WS - TR030_09_0	●
WS Max WS - TR030_12_0	×
WS Max WS - TR030_18_0	▲
WS Max WS - TR030_24_0	▲
WS Max WS - TR030_36_0	▲
Ground	■
Levee	□
Bank Sta	●

Studio Scandicci Torrenti Greve-Vingone
River = Fosso Dogaia Reach = Dogaia_02 RS = 46 DO1014_b

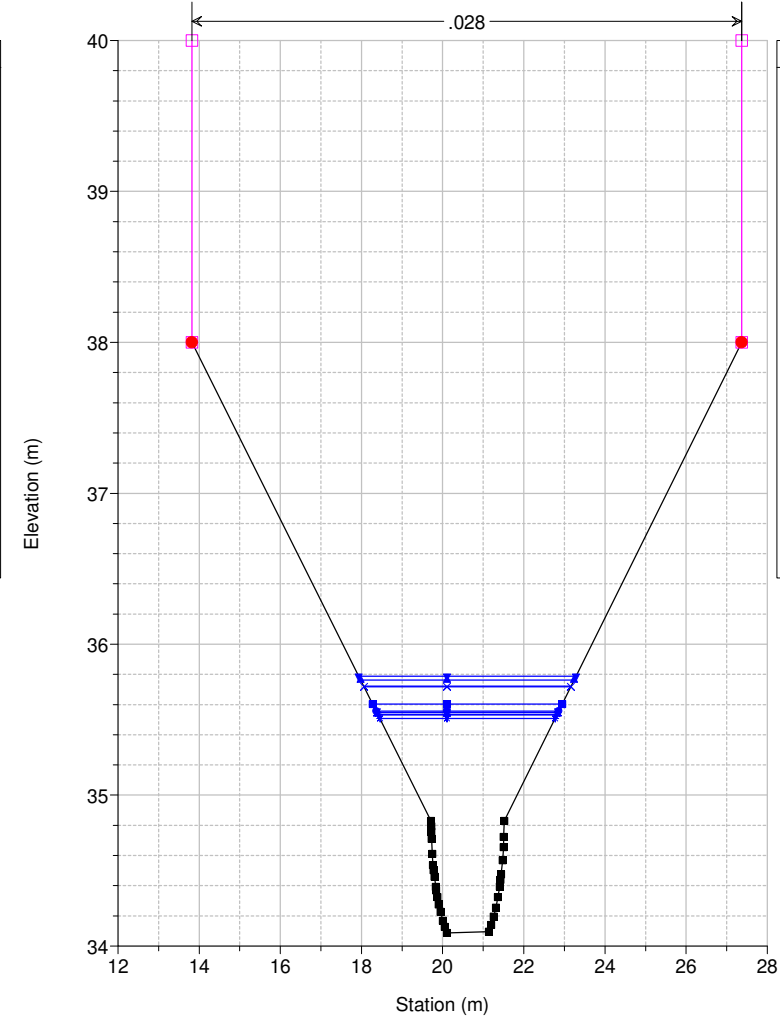

Legend	
WS Max WS - TR030_01_5	▲
WS Max WS - TR030_01_0	▲
WS Max WS - TR030_00_5	×
WS Max WS - TR030_03_0	■
WS Max WS - TR030_06_0	●
WS Max WS - TR030_09_0	●
WS Max WS - TR030_12_0	×
WS Max WS - TR030_18_0	▲
WS Max WS - TR030_24_0	▲
WS Max WS - TR030_36_0	▲
Ground	■
Levee	□
Bank Sta	●

Studio Scandicci Torrenti Greve-Vingone
River = Fosso Dogaia Reach = Dogaia_02 RS = 45.5 BR

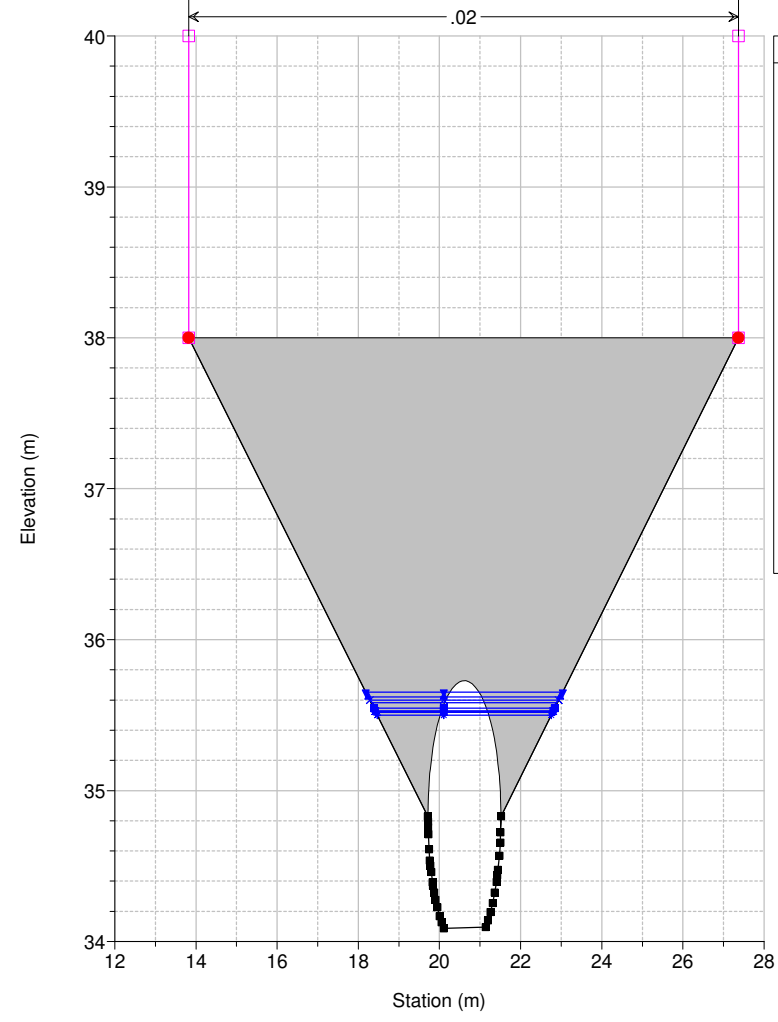

Legend	
WS Max WS - TR030_01_5	▲
WS Max WS - TR030_01_0	▲
WS Max WS - TR030_03_0	×
WS Max WS - TR030_00_5	■
WS Max WS - TR030_06_0	●
WS Max WS - TR030_09_0	●
WS Max WS - TR030_12_0	×
WS Max WS - TR030_18_0	▲
WS Max WS - TR030_24_0	▲
WS Max WS - TR030_36_0	▲
Ground	■
Levee	□
Bank Sta	●

Studio Scandicci Torrenti Greve-Vingone
River = Fosso Dogaia Reach = Dogaia_02 RS = 45.5 BR

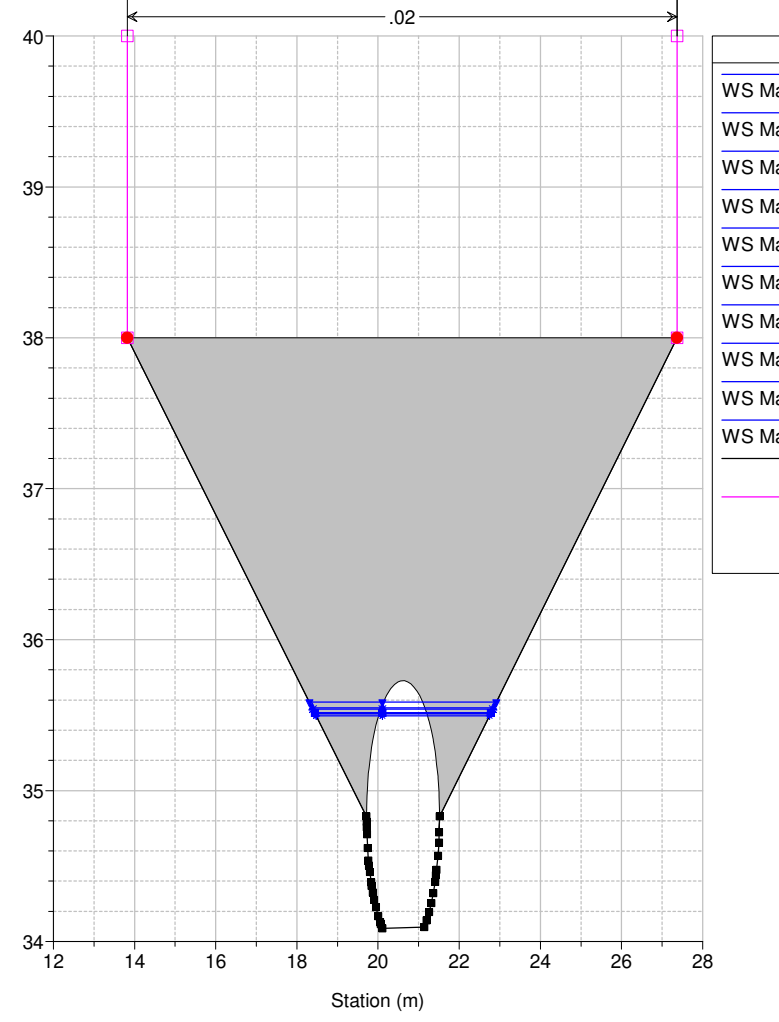

Legend	
WS Max WS - TR030_01_5	▲
WS Max WS - TR030_01_0	▲
WS Max WS - TR030_03_0	×
WS Max WS - TR030_00_5	■
WS Max WS - TR030_06_0	●
WS Max WS - TR030_09_0	●
WS Max WS - TR030_12_0	×
WS Max WS - TR030_18_0	▲
WS Max WS - TR030_24_0	▲
WS Max WS - TR030_00_5	■
WS Max WS - TR030_09_0	●
WS Max WS - TR030_36_0	▲
Ground	■
Levee	□
Bank Sta	●

Studio Scandicci Torrenti Greve-Vingone
River = Fosso Dogaia Reach = Dogaia_02 RS = 45 DO1014_C

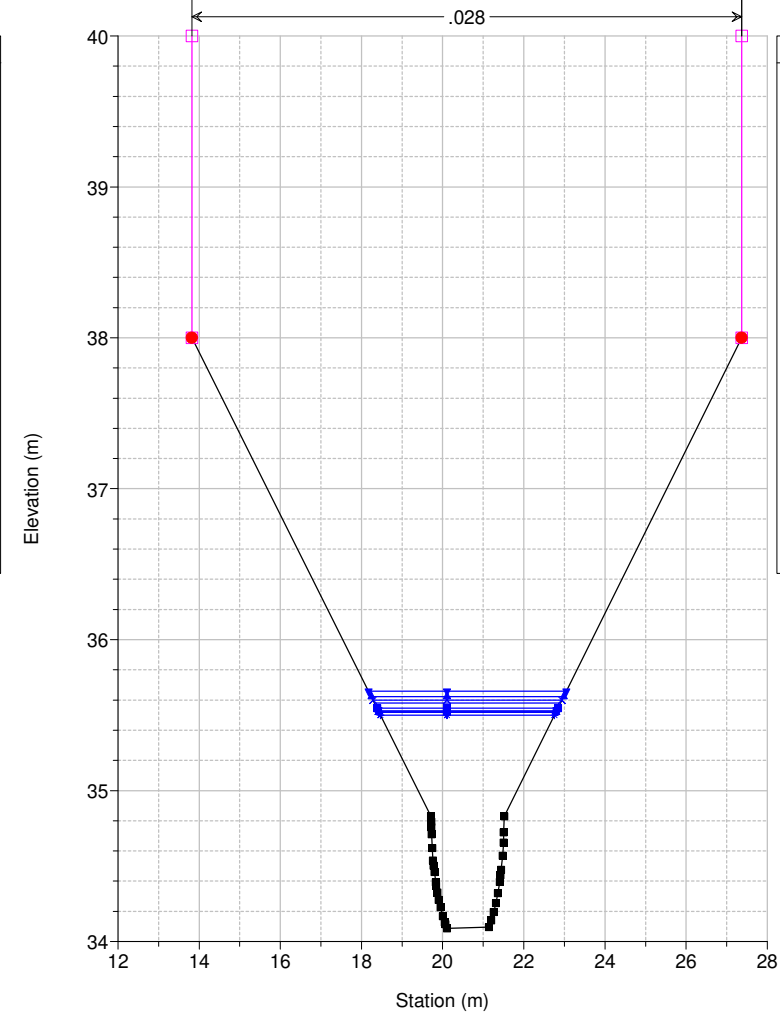

Legend	
WS Max WS - TR030_01_5	▲
WS Max WS - TR030_01_0	▲
WS Max WS - TR030_03_0	×
WS Max WS - TR030_00_5	■
WS Max WS - TR030_06_0	●
WS Max WS - TR030_09_0	●
WS Max WS - TR030_12_0	×
WS Max WS - TR030_18_0	▲
WS Max WS - TR030_24_0	▲
WS Max WS - TR030_36_0	▲
Ground	■
Levee	□
Bank Sta	●

Studio Scandicci Torrenti Greve-Vingone
River = Fosso Dogaia Reach = Dogaia_02 RS = 44 DO1014_D

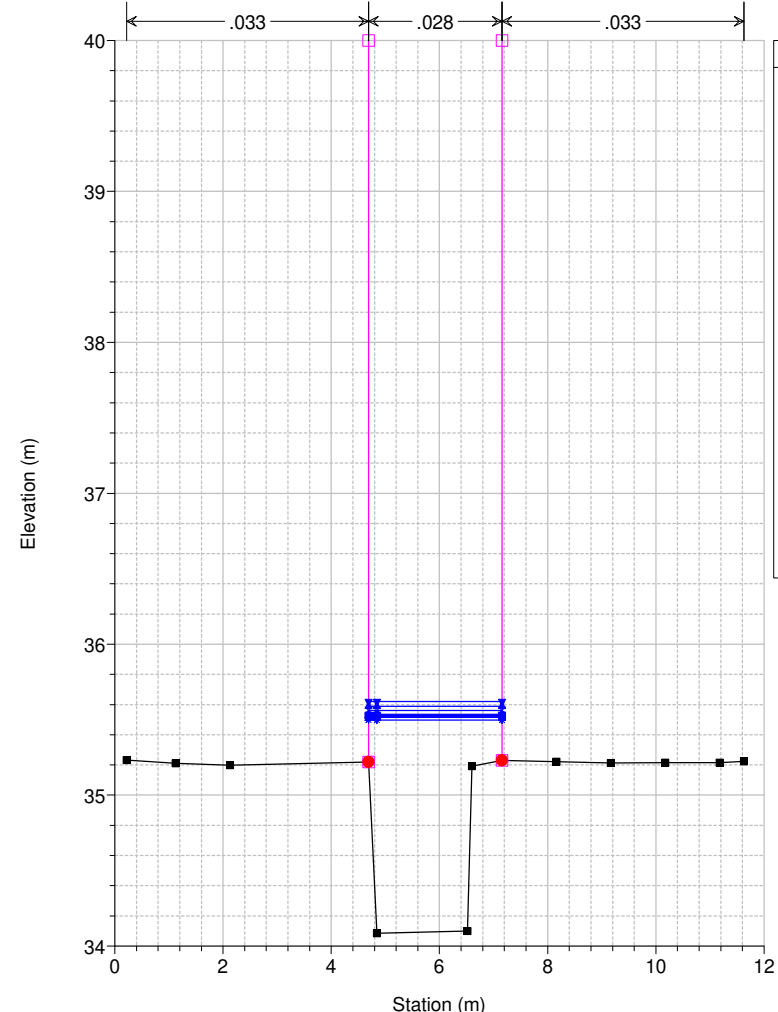

Legend	
WS Max WS - TR030_01_5	▲
WS Max WS - TR030_01_0	▲
WS Max WS - TR030_03_0	×
WS Max WS - TR030_00_5	■
WS Max WS - TR030_06_0	■
WS Max WS - TR030_12_0	×
WS Max WS - TR030_18_0	●
WS Max WS - TR030_09_0	●
WS Max WS - TR030_24_0	▲
WS Max WS - TR030_36_0	▲
Ground	■
Levee	□
Bank Sta	●

Studio Scandicci Torrenti Greve-Vingone
River = Fosso Dogaia Reach = Dogaia_02 RS = 43 DO1015_A

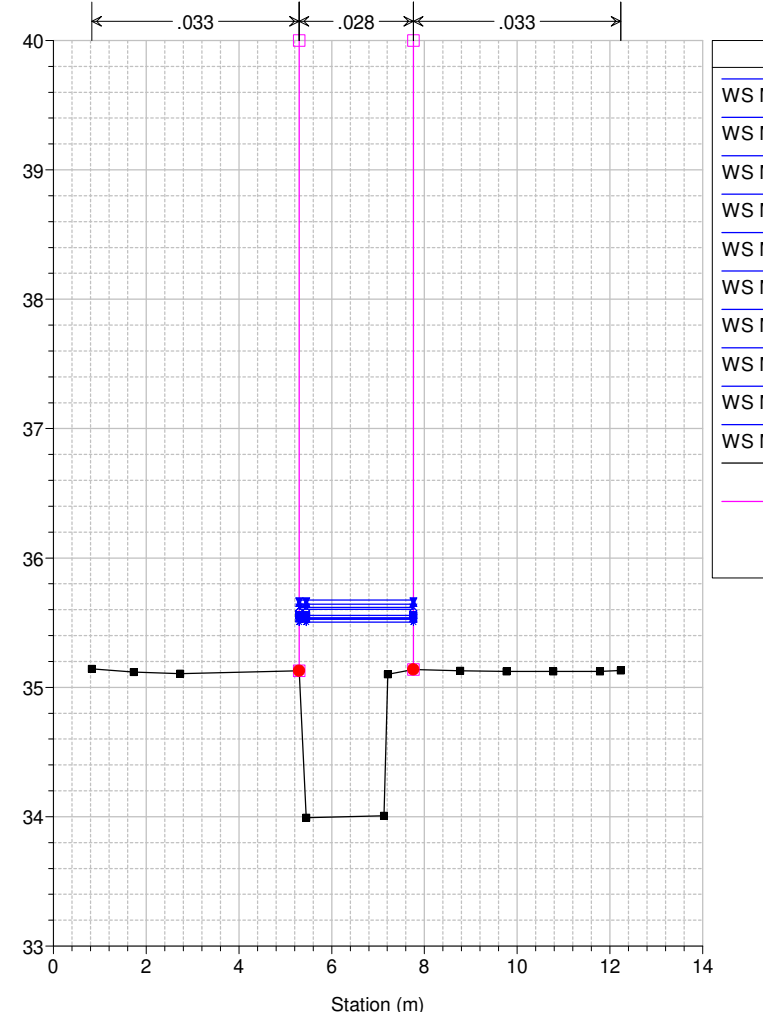

Legend	
WS Max WS - TR030_01_5	▲
WS Max WS - TR030_01_0	▲
WS Max WS - TR030_03_0	×
WS Max WS - TR030_00_5	■
WS Max WS - TR030_06_0	■
WS Max WS - TR030_09_0	●
WS Max WS - TR030_12_0	×
WS Max WS - TR030_18_0	●
WS Max WS - TR030_24_0	▲
WS Max WS - TR030_36_0	▲
Ground	■
Levee	□
Bank Sta	●

Studio Scandicci Torrenti Greve-Vingone
River = Fosso Dogaia Reach = Dogaia_02 RS = 42 DO1015_B

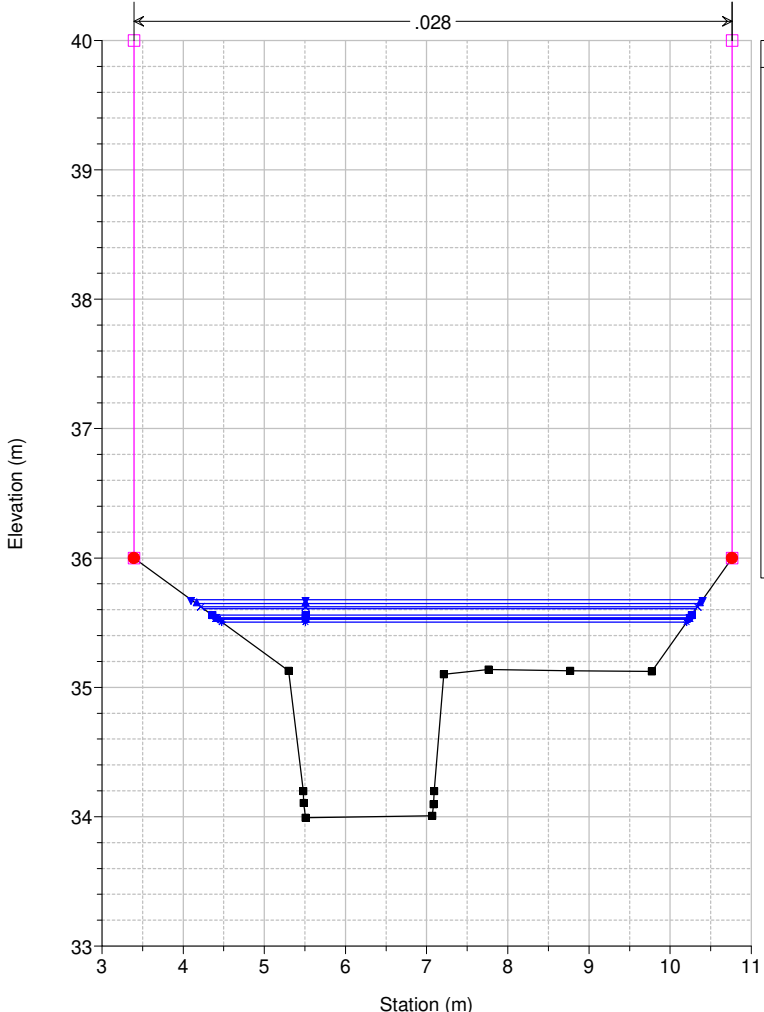

Legend	
WS Max WS - TR030_01_5	▲
WS Max WS - TR030_01_0	▲
WS Max WS - TR030_03_0	×
WS Max WS - TR030_00_5	■
WS Max WS - TR030_06_0	■
WS Max WS - TR030_09_0	●
WS Max WS - TR030_12_0	×
WS Max WS - TR030_18_0	●
WS Max WS - TR030_24_0	▲
WS Max WS - TR030_36_0	▲
Ground	■
Levee	□
Bank Sta	●

Studio Scandicci Torrenti Greve-Vingone
River = Fosso Dogaia Reach = Dogaia_02 RS = 41.5 BR

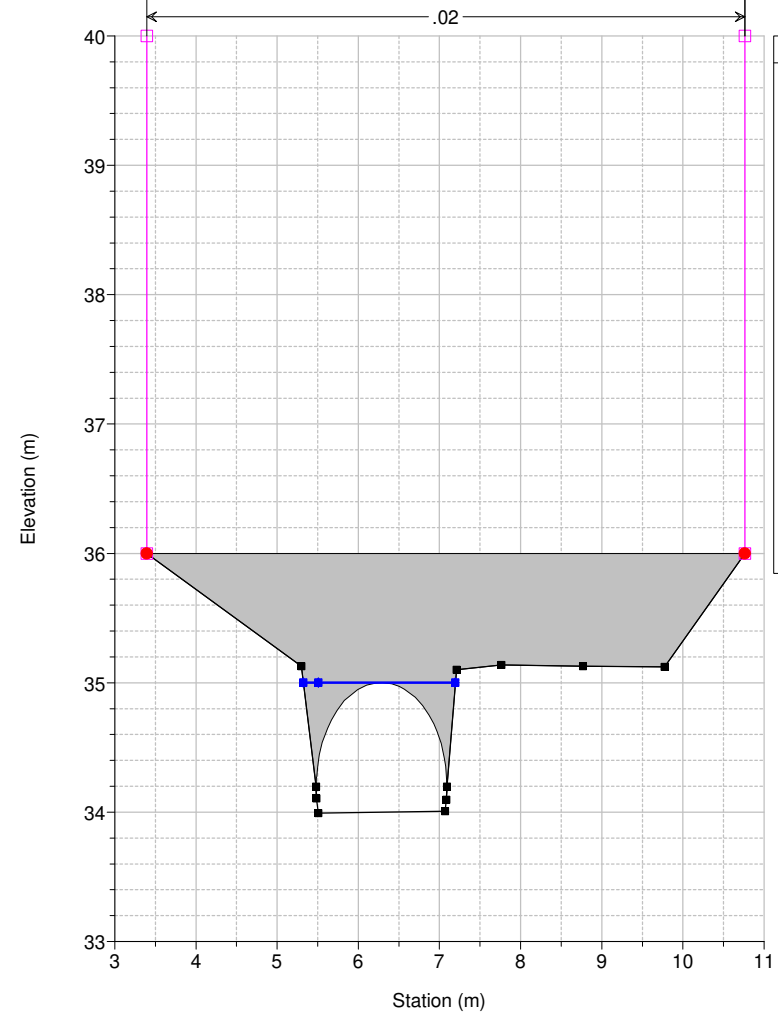

Legend	
WS Max WS - TR030_00_5	▲
WS Max WS - TR030_01_0	▲
WS Max WS - TR030_01_5	▲
WS Max WS - TR030_03_0	×
WS Max WS - TR030_06_0	■
WS Max WS - TR030_09_0	●
WS Max WS - TR030_12_0	×
WS Max WS - TR030_18_0	●
WS Max WS - TR030_24_0	▲
WS Max WS - TR030_36_0	▲
Ground	■
Levee	□
Bank Sta	●

Studio Scandicci Torrenti Greve-Vingone
River = Fosso Dogaia Reach = Dogaia_02 RS = 41.5 BR

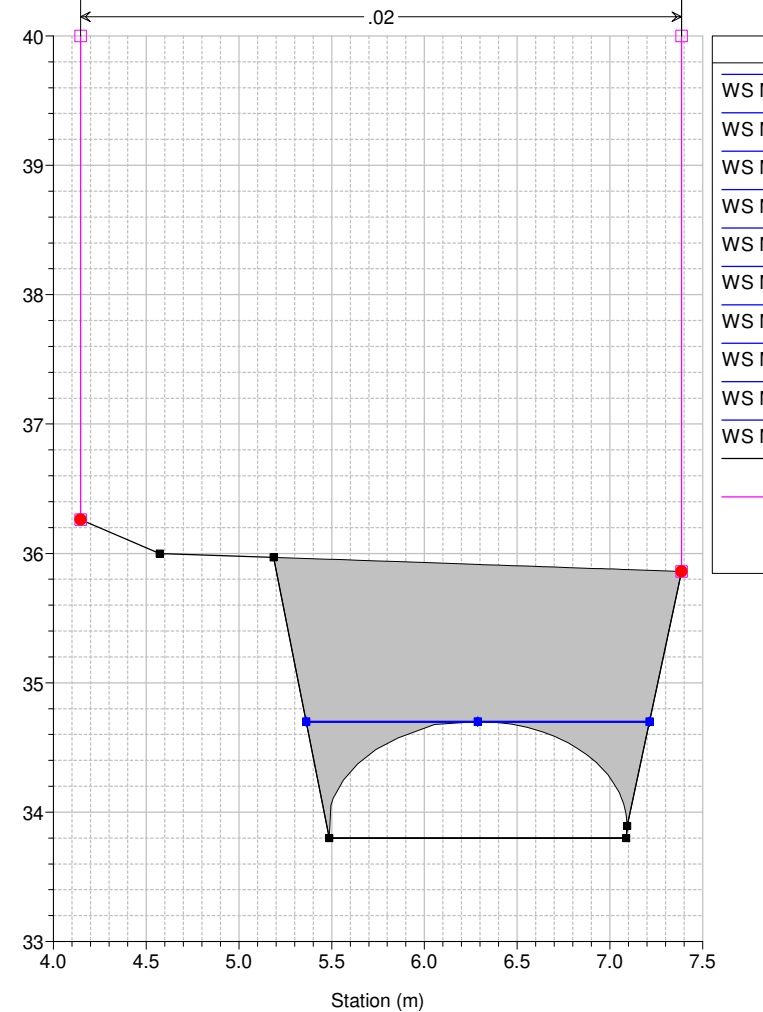

Legend	
WS Max WS - TR030_00_5	▲
WS Max WS - TR030_01_0	▲
WS Max WS - TR030_01_5	▲
WS Max WS - TR030_03_0	×
WS Max WS - TR030_06_0	■
WS Max WS - TR030_09_0	●
WS Max WS - TR030_12_0	×
WS Max WS - TR030_18_0	●
WS Max WS - TR030_24_0	▲
WS Max WS - TR030_36_0	▲
Ground	■
Levee	□
Bank Sta	●

Studio Scandicci Torrenti Greve-Vingone
River = Fosso Dogaia Reach = Dogaia_02 RS = 41 DO1015_C

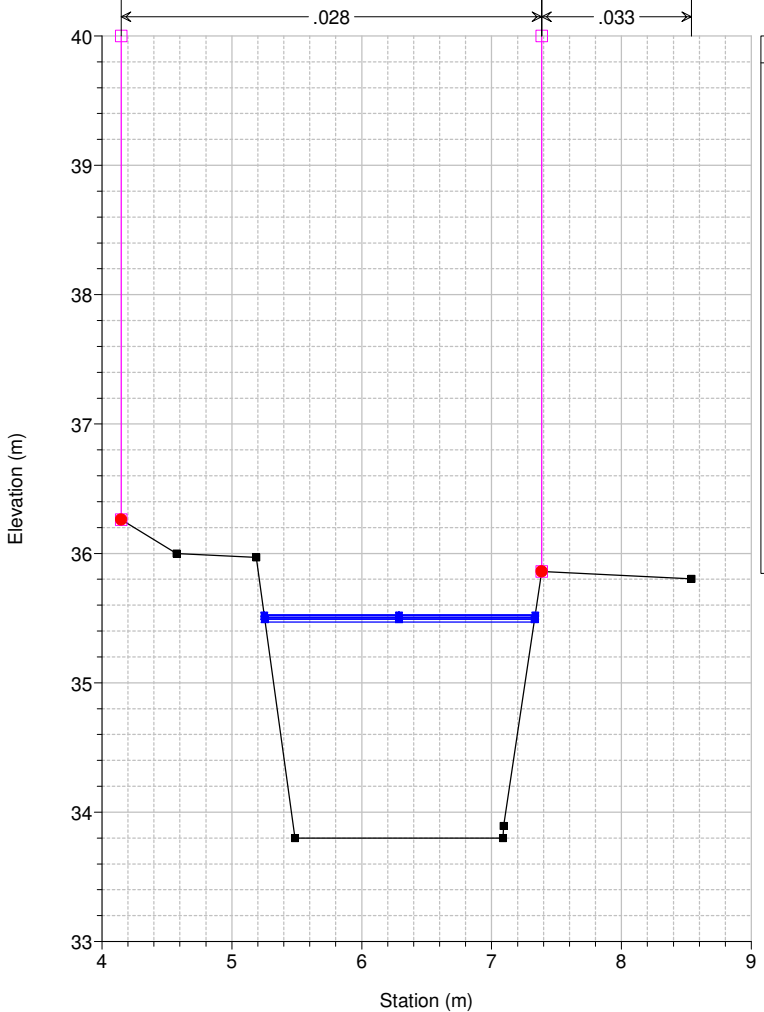

Legend	
WS Max WS - TR030_18_0	▲
WS Max WS - TR030_01_5	▲
WS Max WS - TR030_24_0	▲
WS Max WS - TR030_12_0	×
WS Max WS - TR030_09_0	●
WS Max WS - TR030_01_0	▲
WS Max WS - TR030_36_0	▲
WS Max WS - TR030_03_0	×
WS Max WS - TR030_06_0	■
WS Max WS - TR030_00_5	■
Ground	■
Levee	□
Bank Sta	●

Studio Scandicci Torrenti Greve-Vingone
River = Fosso Dogaia Reach = Dogaia_02 RS = 40 DO1015_D

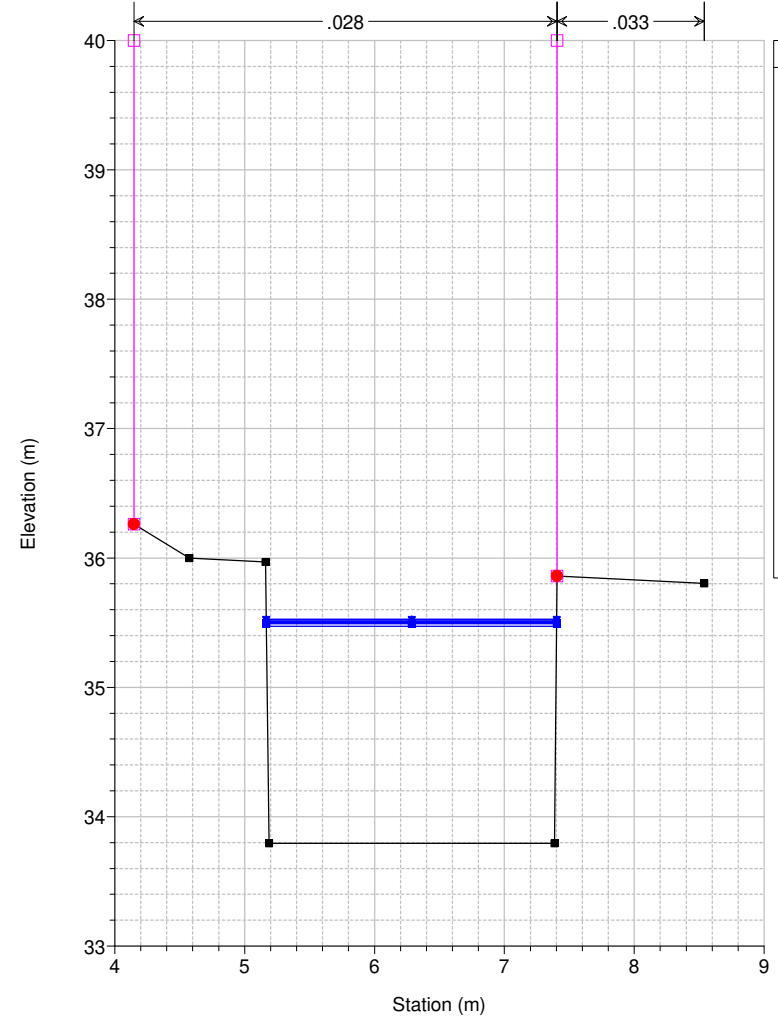

Legend	
WS Max WS - TR030_01_5	▲
WS Max WS - TR030_18_0	▲
WS Max WS - TR030_24_0	▲
WS Max WS - TR030_12_0	▲
WS Max WS - TR030_01_0	▲
WS Max WS - TR030_09_0	▲
WS Max WS - TR030_36_0	▲
WS Max WS - TR030_03_0	▲
WS Max WS - TR030_06_0	▲
WS Max WS - TR030_00_5	▲
Ground	■
Levee	□
Bank Sta	●

Studio Scandicci Torrenti Greve-Vingone
River = Fosso Dogaia Reach = Dogaia_02 RS = 39 DO1016_A

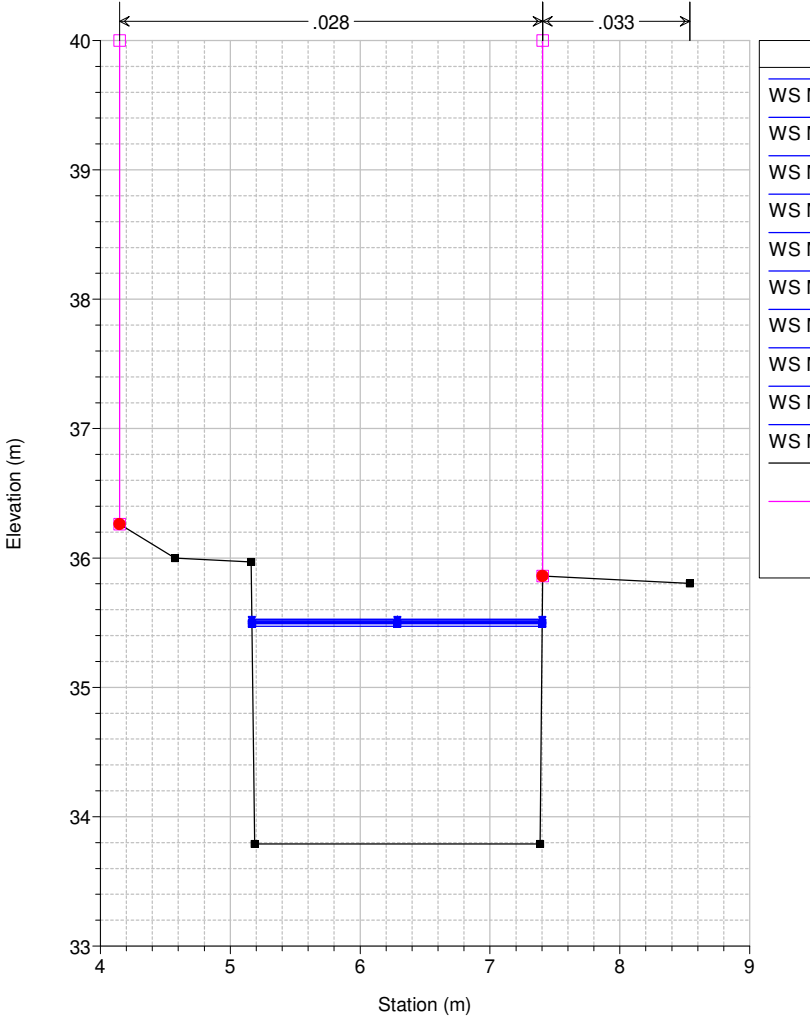

Legend	
WS Max WS - TR030_01_5	▲
WS Max WS - TR030_18_0	▲
WS Max WS - TR030_24_0	▲
WS Max WS - TR030_12_0	▲
WS Max WS - TR030_01_0	▲
WS Max WS - TR030_09_0	▲
WS Max WS - TR030_36_0	▲
WS Max WS - TR030_03_0	▲
WS Max WS - TR030_06_0	▲
WS Max WS - TR030_00_5	▲
Ground	■
Levee	□
Bank Sta	●

Studio Scandicci Torrenti Greve-Vingone
River = Fosso Dogaia Reach = Dogaia_02 RS = 38 DO1016_B

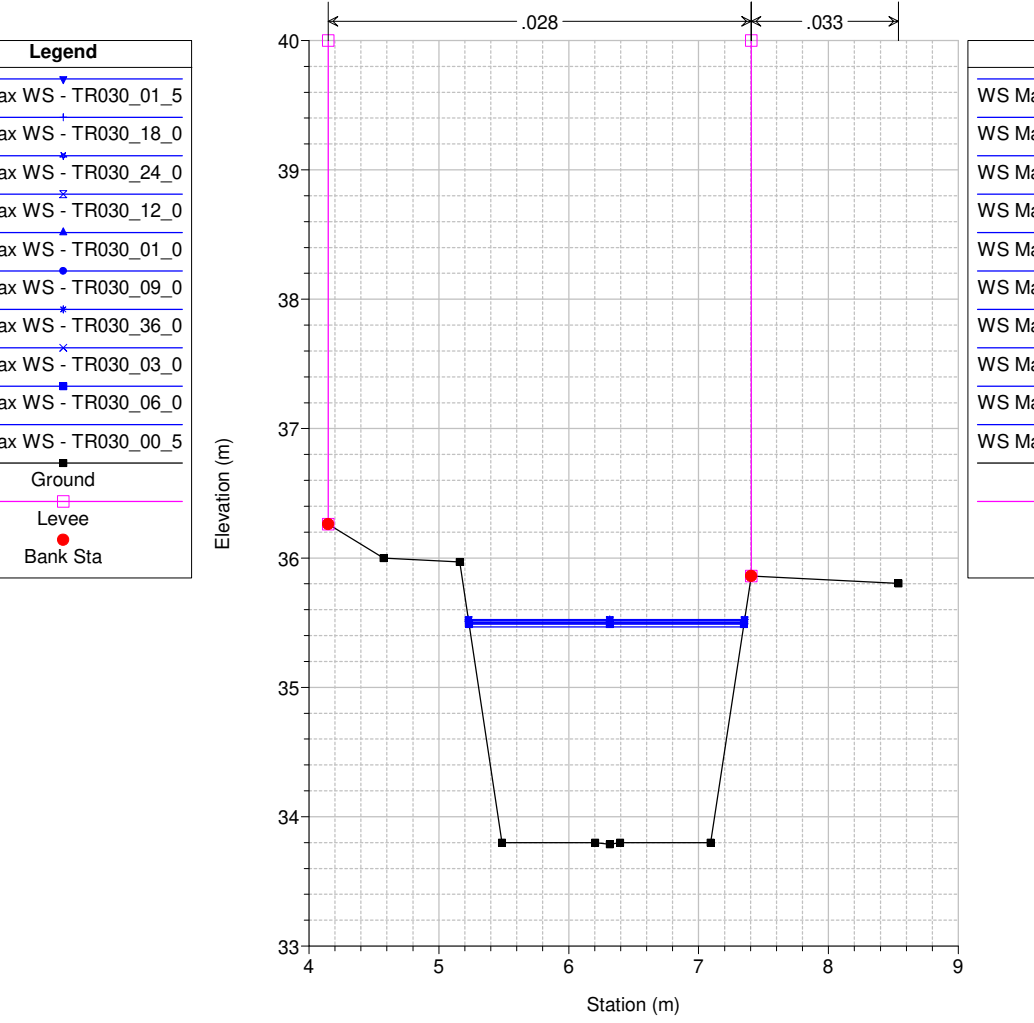

Legend	
WS Max WS - TR030_18_0	▲
WS Max WS - TR030_01_5	▲
WS Max WS - TR030_24_0	▲
WS Max WS - TR030_12_0	▲
WS Max WS - TR030_09_0	▲
WS Max WS - TR030_01_0	▲
WS Max WS - TR030_36_0	▲
WS Max WS - TR030_03_0	▲
WS Max WS - TR030_06_0	▲
WS Max WS - TR030_00_5	▲
Ground	■
Levee	□
Bank Sta	●

Studio Scandicci Torrenti Greve-Vingone
River = Fosso Dogaia Reach = Dogaia_02 RS = 37.5 BR

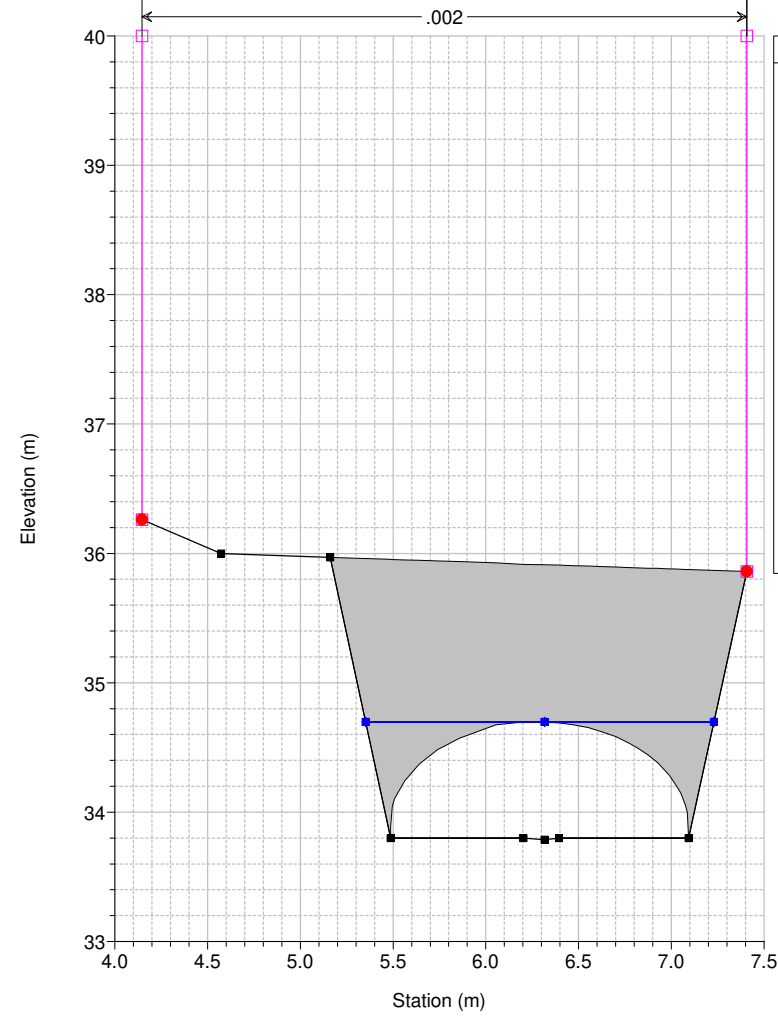

Legend	
WS Max WS - TR030_00_5	▲
WS Max WS - TR030_01_0	▲
WS Max WS - TR030_01_5	▲
WS Max WS - TR030_03_0	▲
WS Max WS - TR030_06_0	▲
WS Max WS - TR030_09_0	▲
WS Max WS - TR030_12_0	▲
WS Max WS - TR030_18_0	▲
WS Max WS - TR030_24_0	▲
WS Max WS - TR030_36_0	▲
Ground	■
Levee	□
Bank Sta	●

Studio Scandicci Torrenti Greve-Vingone
River = Fosso Dogaia Reach = Dogaia_02 RS = 37.5 BR

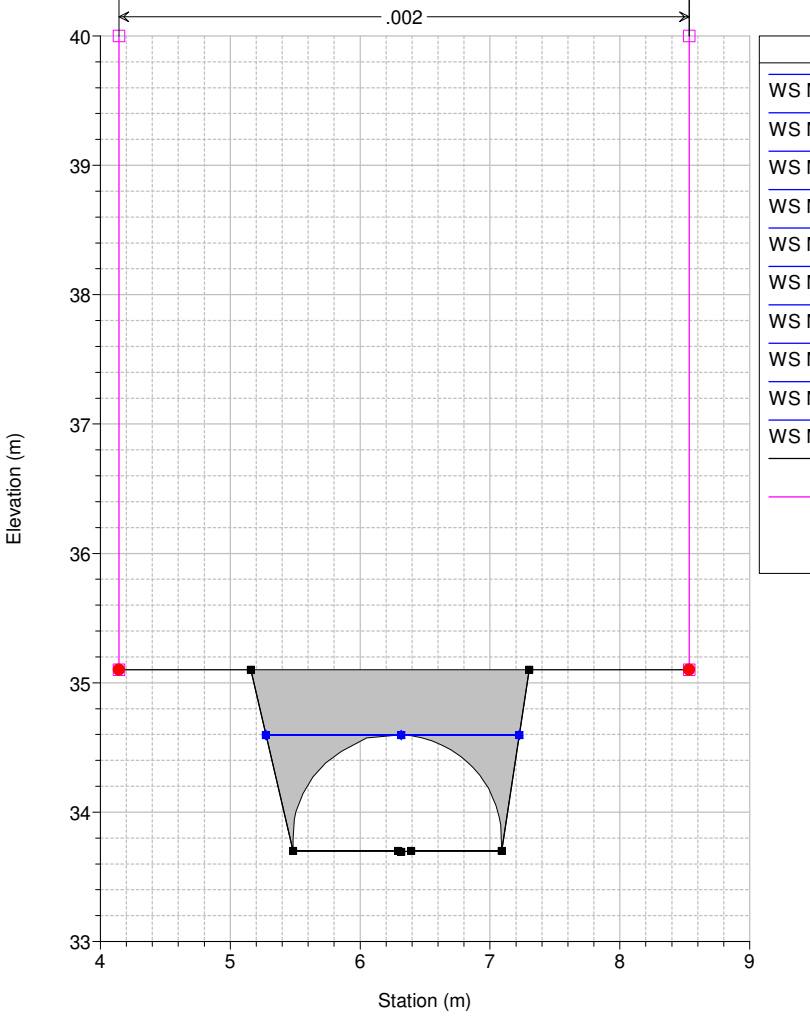

Legend	
WS Max WS - TR030_00_5	▲
WS Max WS - TR030_01_0	▲
WS Max WS - TR030_01_5	▲
WS Max WS - TR030_03_0	▲
WS Max WS - TR030_06_0	▲
WS Max WS - TR030_09_0	▲
WS Max WS - TR030_12_0	▲
WS Max WS - TR030_18_0	▲
WS Max WS - TR030_24_0	▲
WS Max WS - TR030_36_0	▲
Ground	■
Levee	□
Bank Sta	●

Studio Scandicci Torrenti Greve-Vingone
River = Fosso Dogaia Reach = Dogaia_02 RS = 37 DO1016_C

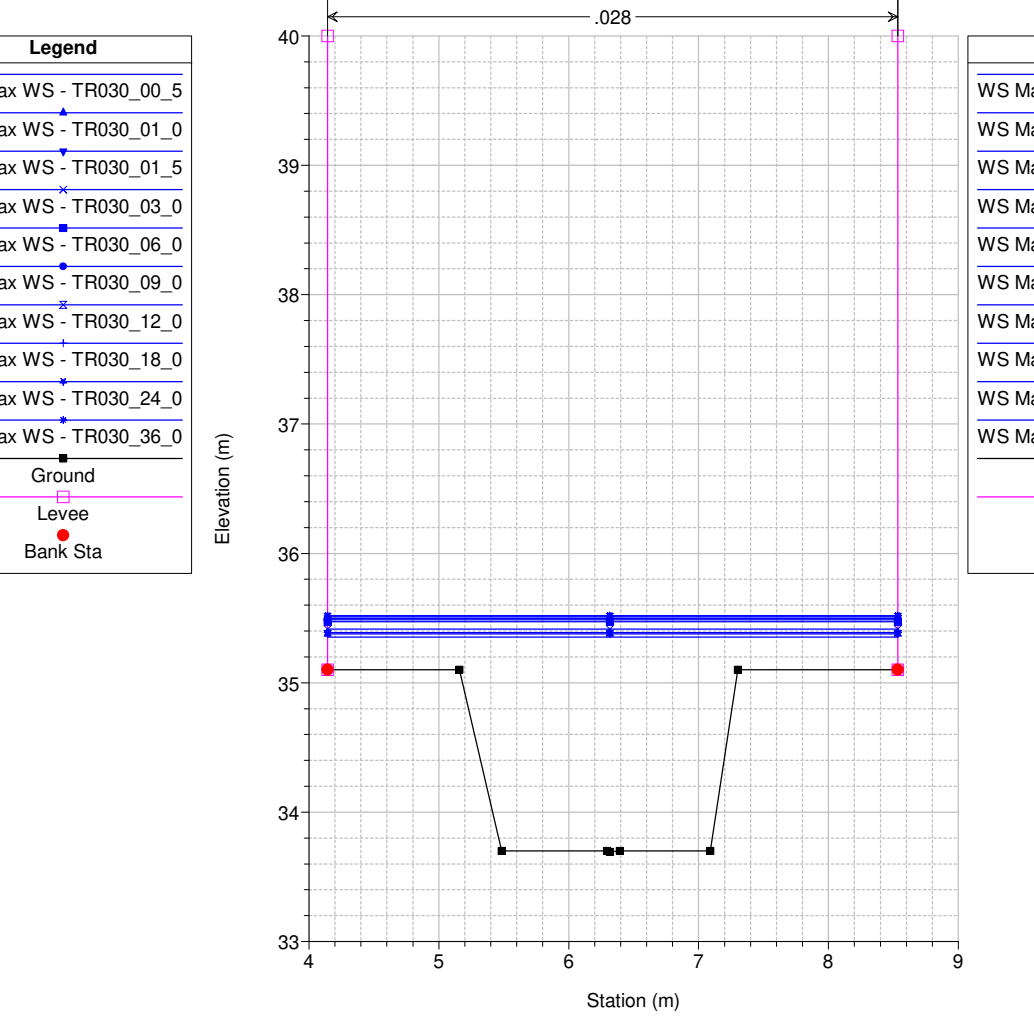

Legend	
WS Max WS - TR030_18_0	▲
WS Max WS - TR030_24_0	▲
WS Max WS - TR030_12_0	▲
WS Max WS - TR030_36_0	▲
WS Max WS - TR030_09_0	▲
WS Max WS - TR030_06_0	▲
WS Max WS - TR030_03_0	▲
WS Max WS - TR030_01_5	▲
WS Max WS - TR030_01_0	▲
WS Max WS - TR030_00_5	▲
Ground	■
Levee	□
Bank Sta	●

Studio Scandicci Torrenti Greve-Vingone
River = Fosso Dogaia Reach = Dogaia_02 RS = 36 DO1016_D

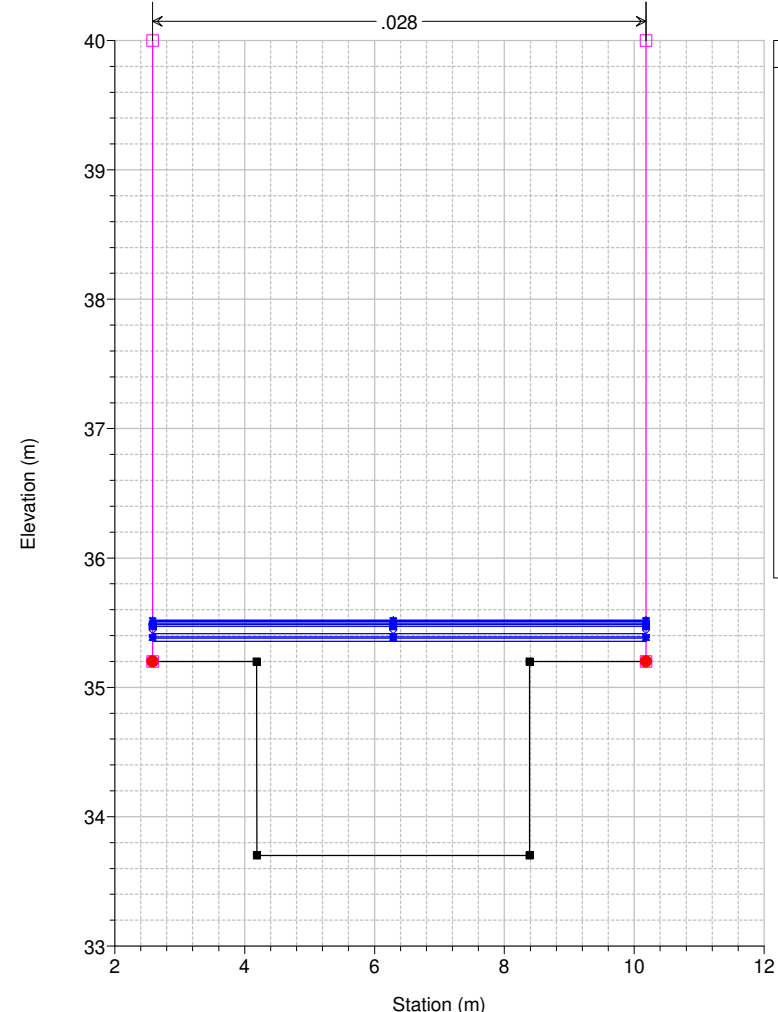

Legend	
WS Max WS - TR030_18_0	▲
WS Max WS - TR030_24_0	▼
WS Max WS - TR030_12_0	✕
WS Max WS - TR030_36_0	●
WS Max WS - TR030_09_0	■
WS Max WS - TR030_06_0	■
WS Max WS - TR030_03_0	✕
WS Max WS - TR030_01_5	▼
WS Max WS - TR030_01_0	▲
WS Max WS - TR030_00_5	■
Ground	■
Levee	□
Bank Sta	●

Studio Scandicci Torrenti Greve-Vingone
River = Fosso Dogaia Reach = Dogaia_02 RS = 35 DO1017_A

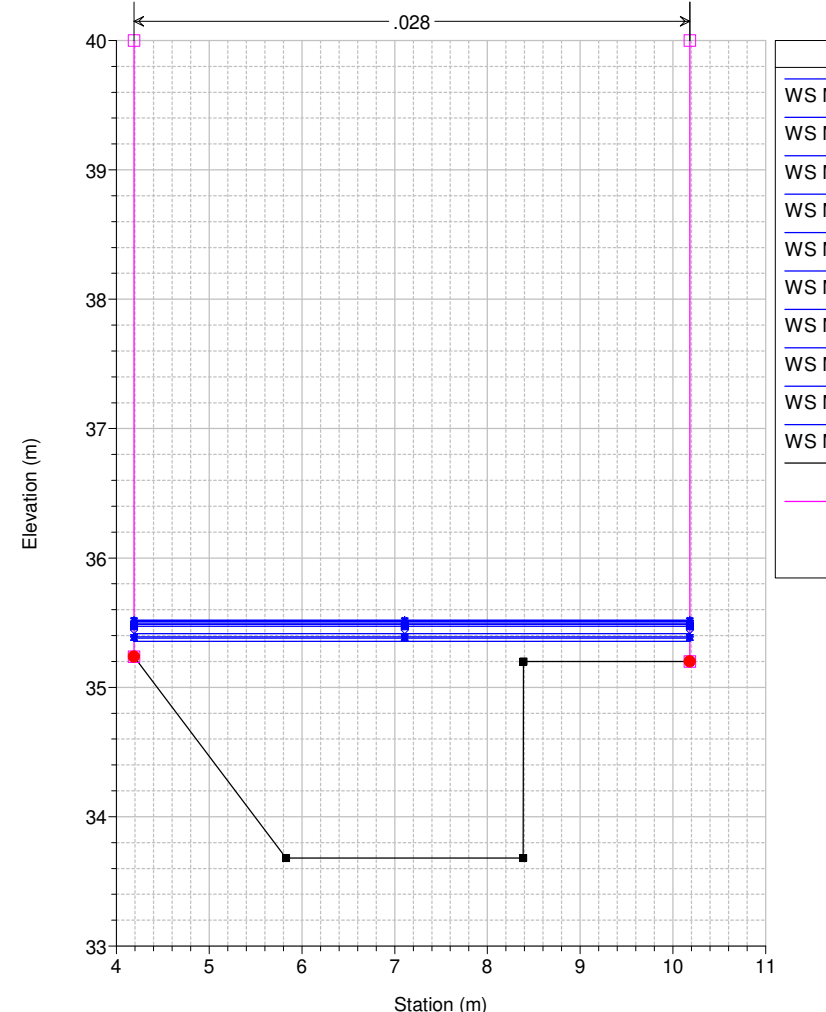

Legend	
WS Max WS - TR030_18_0	▲
WS Max WS - TR030_24_0	▼
WS Max WS - TR030_12_0	✕
WS Max WS - TR030_36_0	●
WS Max WS - TR030_09_0	■
WS Max WS - TR030_06_0	■
WS Max WS - TR030_03_0	✕
WS Max WS - TR030_01_5	▼
WS Max WS - TR030_01_0	▲
WS Max WS - TR030_00_5	■
Ground	■
Levee	□
Bank Sta	●

Studio Scandicci Torrenti Greve-Vingone
River = Fosso Dogaia Reach = Dogaia_02 RS = 34 DO1017_B

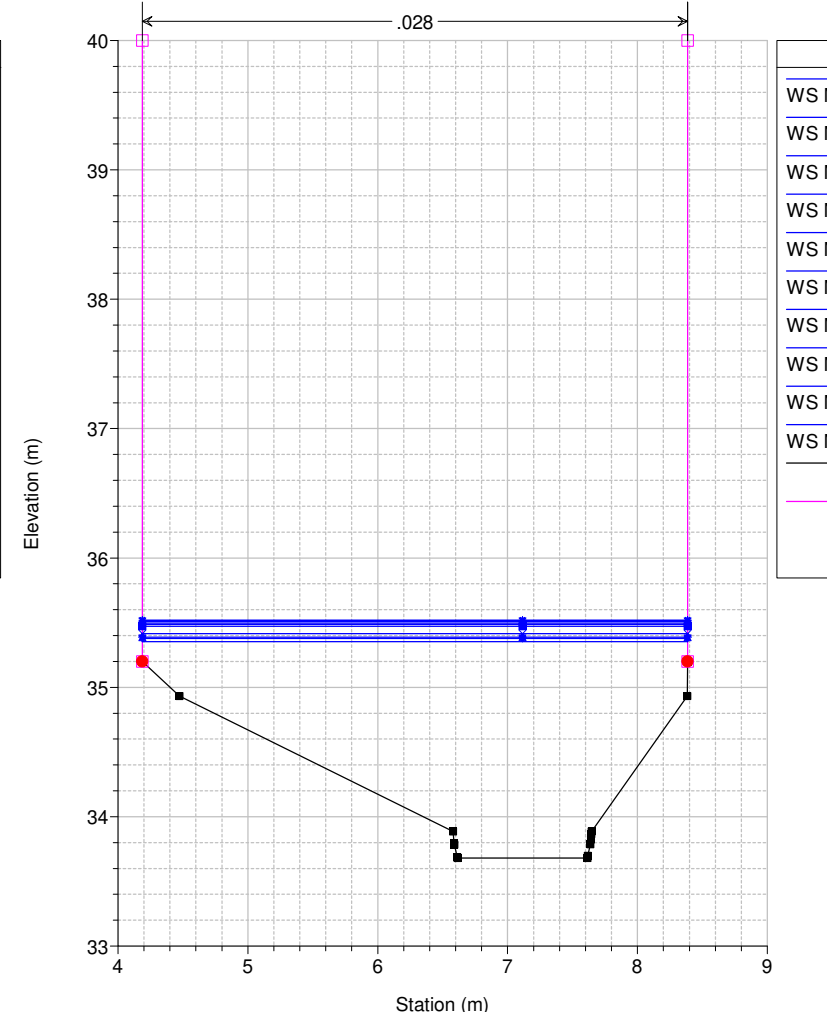

Legend	
WS Max WS - TR030_18_0	▲
WS Max WS - TR030_24_0	▼
WS Max WS - TR030_12_0	✕
WS Max WS - TR030_36_0	●
WS Max WS - TR030_09_0	■
WS Max WS - TR030_06_0	■
WS Max WS - TR030_03_0	✕
WS Max WS - TR030_01_5	▼
WS Max WS - TR030_01_0	▲
WS Max WS - TR030_00_5	■
Ground	■
Levee	□
Bank Sta	●

Studio Scandicci Torrenti Greve-Vingone
River = Fosso Dogaia Reach = Dogaia_02 RS = 33.5 BR

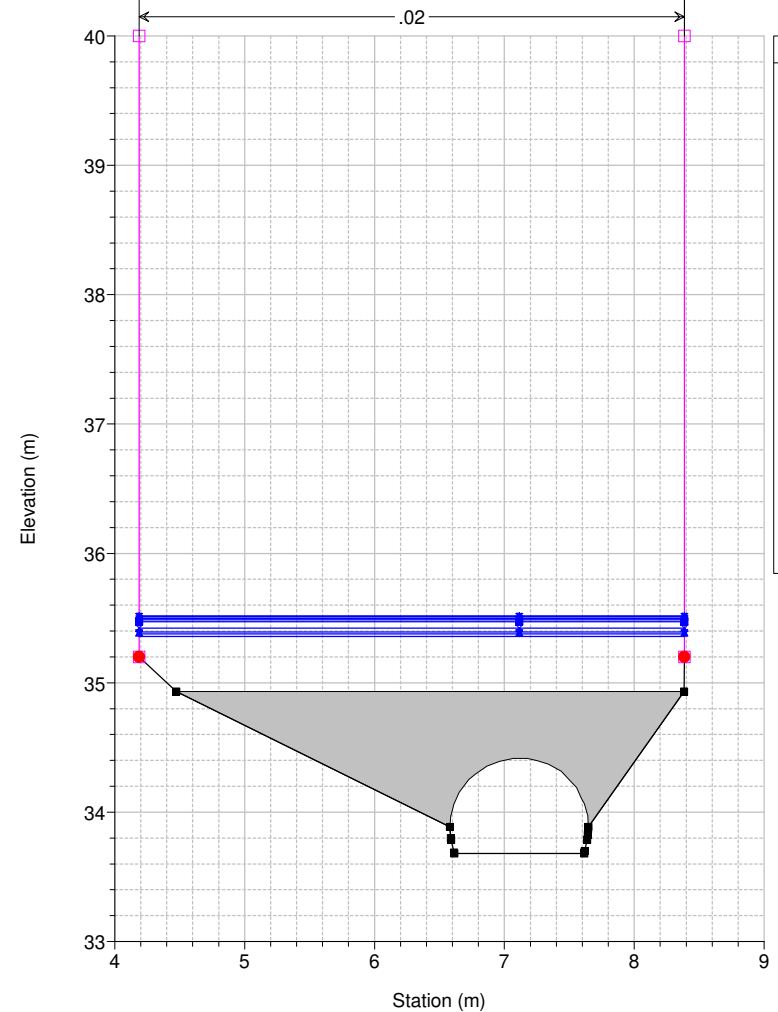

Legend	
WS Max WS - TR030_18_0	▲
WS Max WS - TR030_24_0	▼
WS Max WS - TR030_12_0	✕
WS Max WS - TR030_36_0	●
WS Max WS - TR030_09_0	■
WS Max WS - TR030_06_0	■
WS Max WS - TR030_03_0	✕
WS Max WS - TR030_01_5	▼
WS Max WS - TR030_01_0	▲
WS Max WS - TR030_00_5	■
Ground	■
Levee	□
Bank Sta	●

Studio Scandicci Torrenti Greve-Vingone
River = Fosso Dogaia Reach = Dogaia_02 RS = 33.5 BR

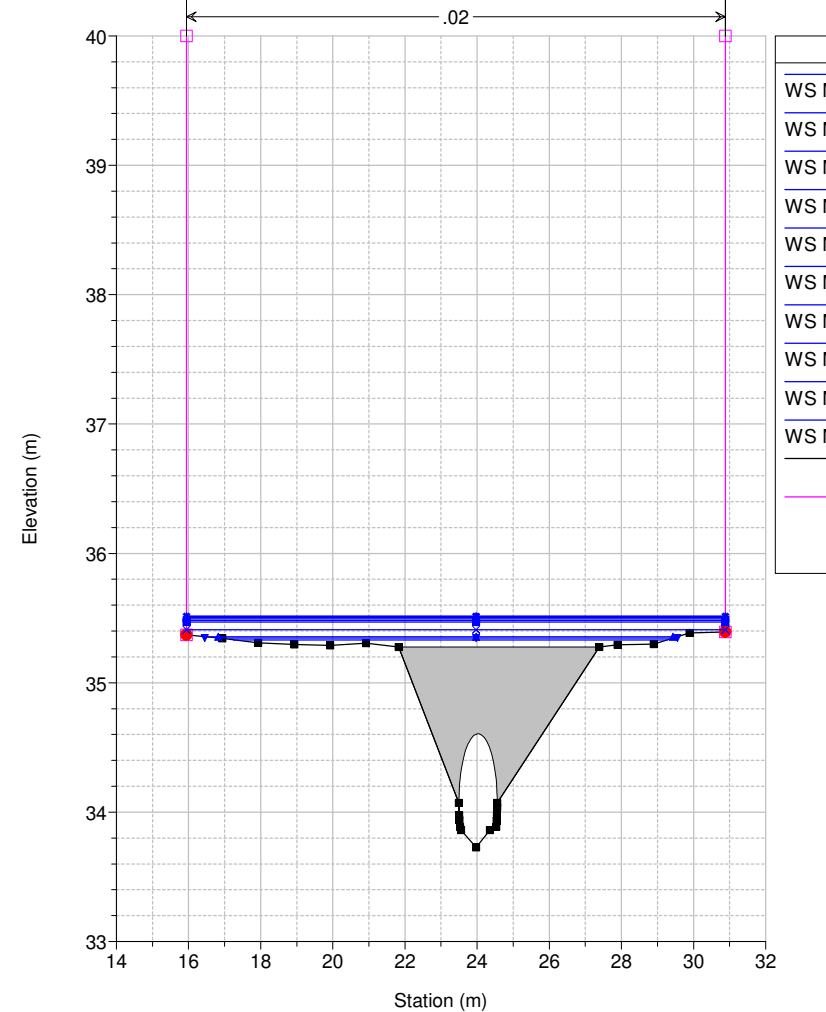

Legend	
WS Max WS - TR030_18_0	▲
WS Max WS - TR030_24_0	▼
WS Max WS - TR030_12_0	✕
WS Max WS - TR030_36_0	●
WS Max WS - TR030_09_0	■
WS Max WS - TR030_06_0	■
WS Max WS - TR030_03_0	✕
WS Max WS - TR030_01_5	▼
WS Max WS - TR030_01_0	▲
WS Max WS - TR030_00_5	■
Ground	■
Levee	□
Bank Sta	●

Studio Scandicci Torrenti Greve-Vingone
River = Fosso Dogaia Reach = Dogaia_02 RS = 33 DO1017_C

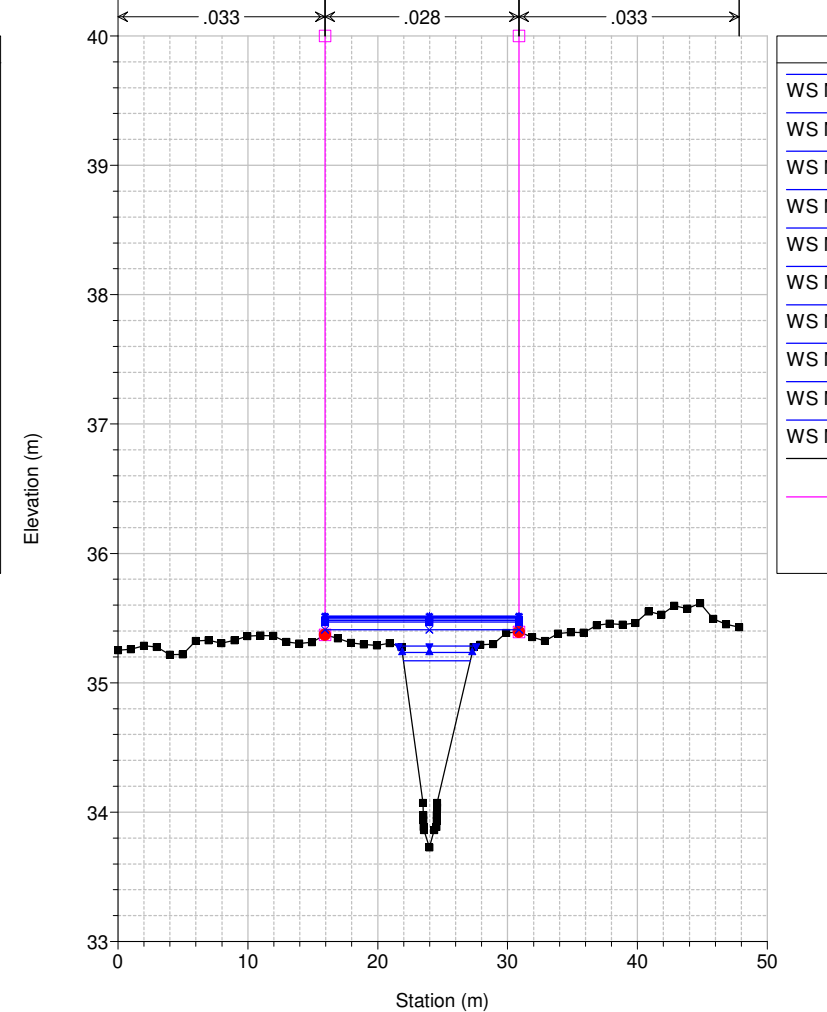

Legend	
WS Max WS - TR030_18_0	▲
WS Max WS - TR030_24_0	▼
WS Max WS - TR030_12_0	✕
WS Max WS - TR030_36_0	●
WS Max WS - TR030_09_0	■
WS Max WS - TR030_06_0	■
WS Max WS - TR030_03_0	✕
WS Max WS - TR030_01_5	▼
WS Max WS - TR030_01_0	▲
WS Max WS - TR030_00_5	■
Ground	■
Levee	□
Bank Sta	●

Studio Scandicci Torrenti Greve-Vingone
River = Fosso Dogaia Reach = Dogaia_02 RS = 32 DO0017_D

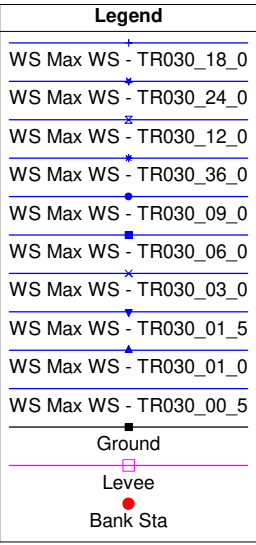
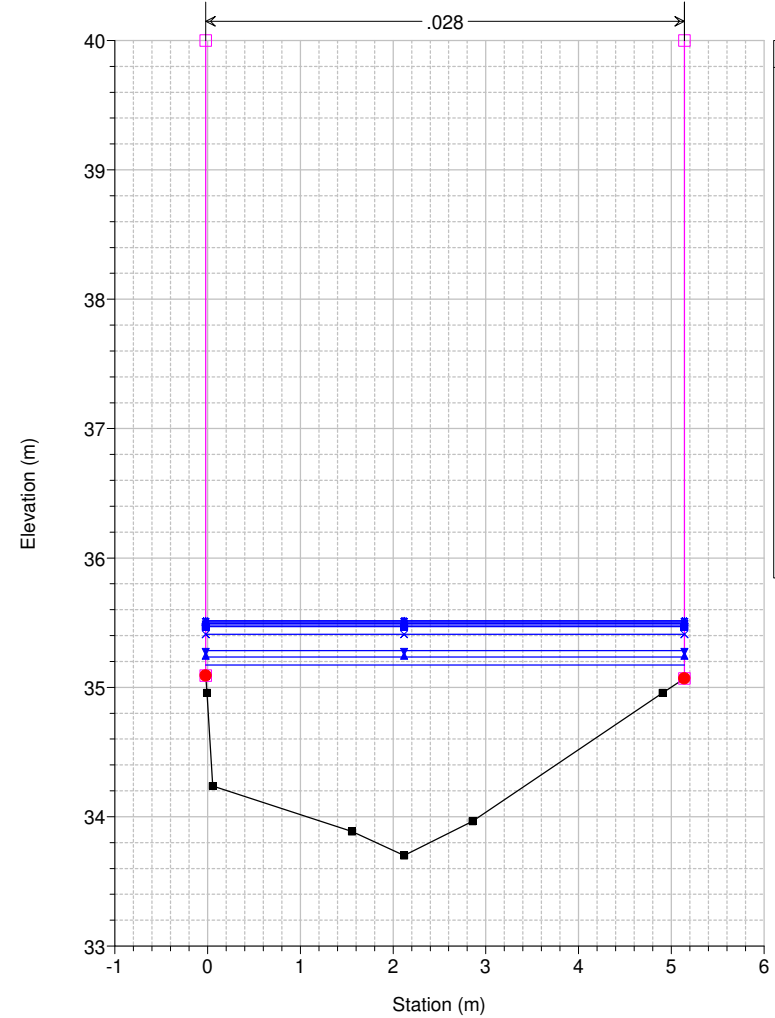

Studio Scandicci Torrenti Greve-Vingone
River = Fosso Dogaia Reach = Dogaia_02 RS = 31 DO0018_

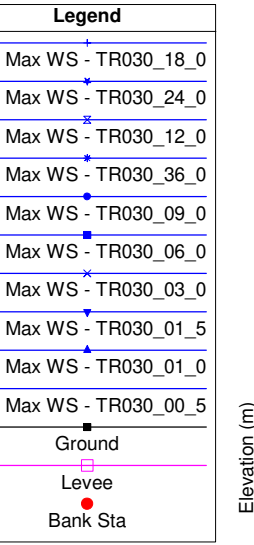
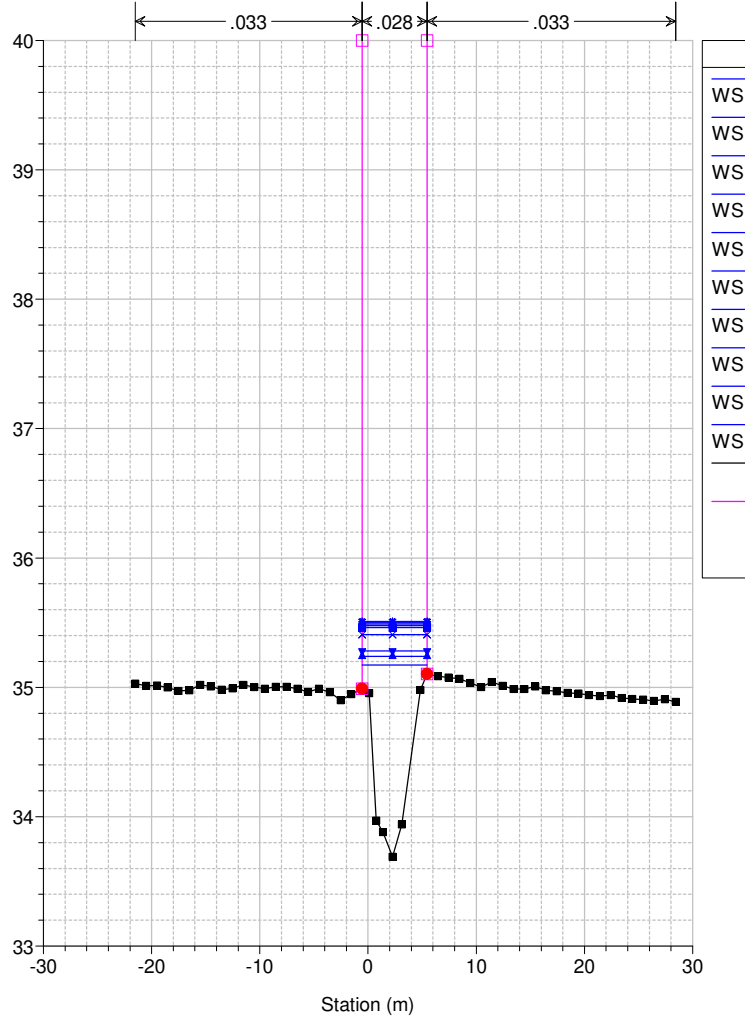

Studio Scandicci Torrenti Greve-Vingone
River = Fosso Dogaia Reach = Dogaia_02 RS = 30 DO0019_

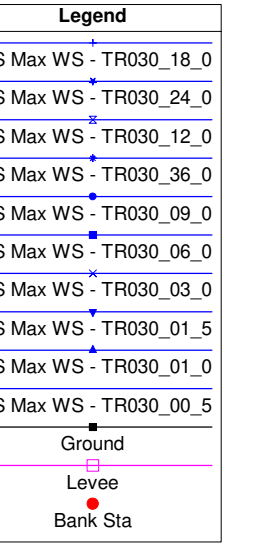
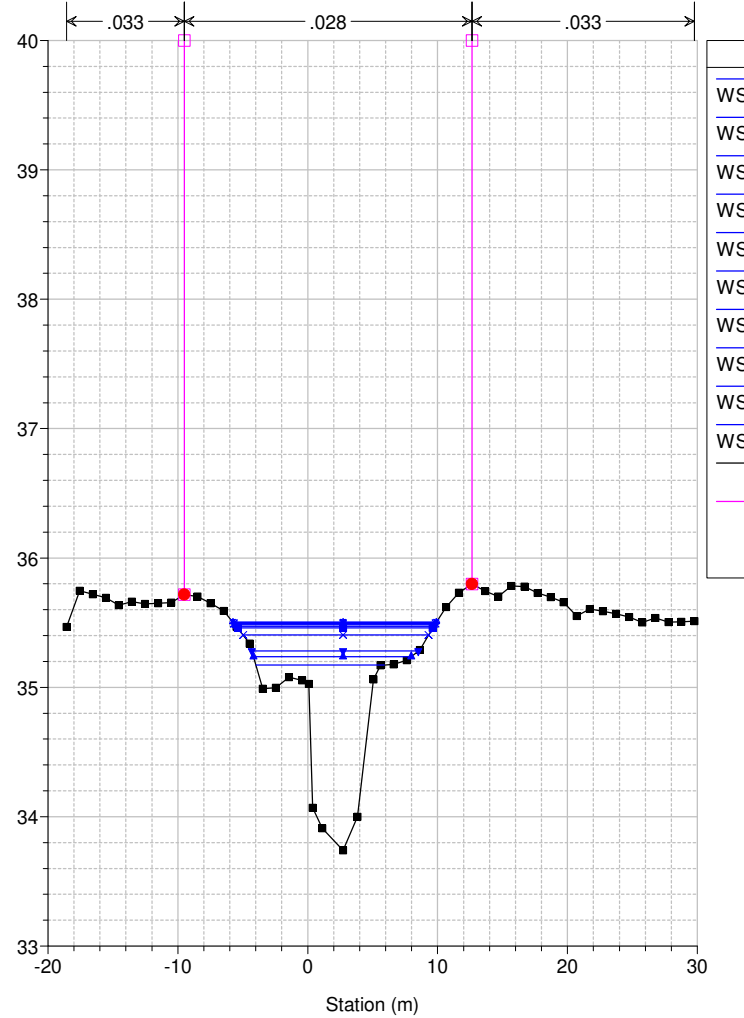

Studio Scandicci Torrenti Greve-Vingone
River = Fosso Dogaia Reach = Dogaia_02 RS = 29 DO0020_

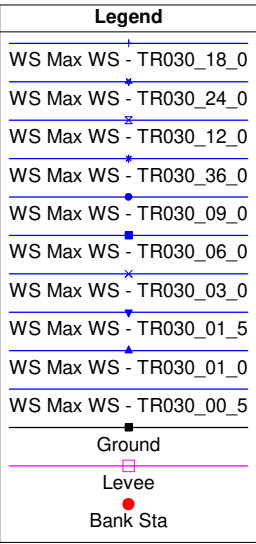
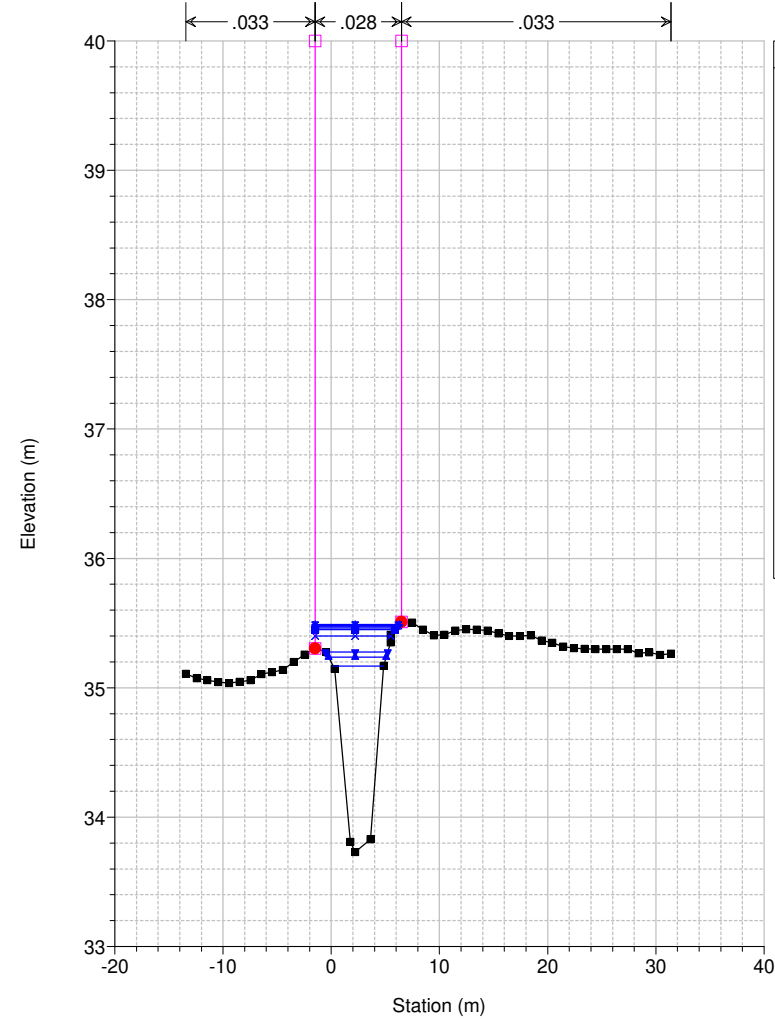

Studio Scandicci Torrenti Greve-Vingone
River = Fosso Dogaia Reach = Dogaia_02 RS = 28 DO1020_A

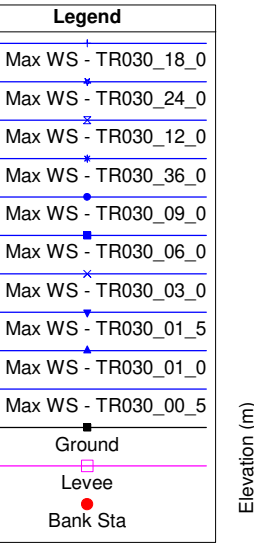
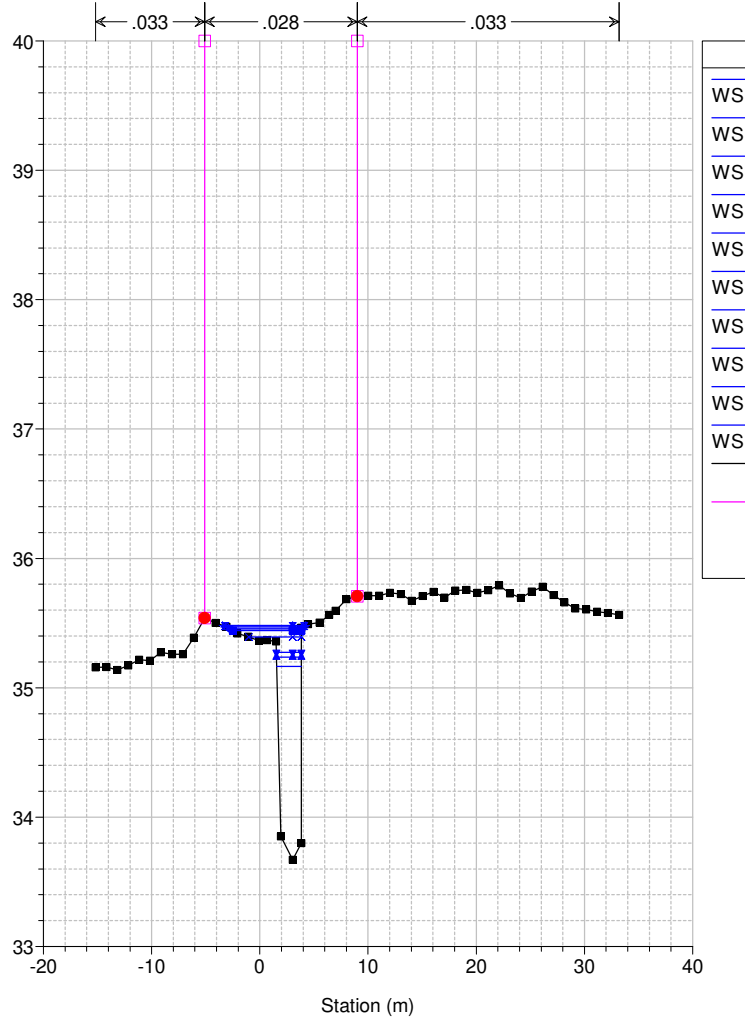

Studio Scandicci Torrenti Greve-Vingone
River = Fosso Dogaia Reach = Dogaia_02 RS = 27 DO1020_B

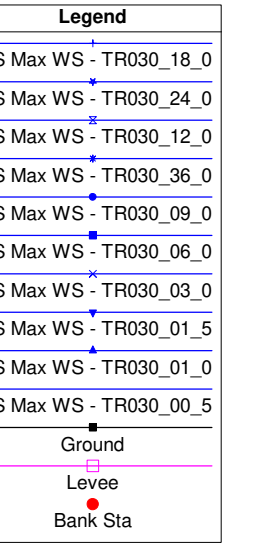
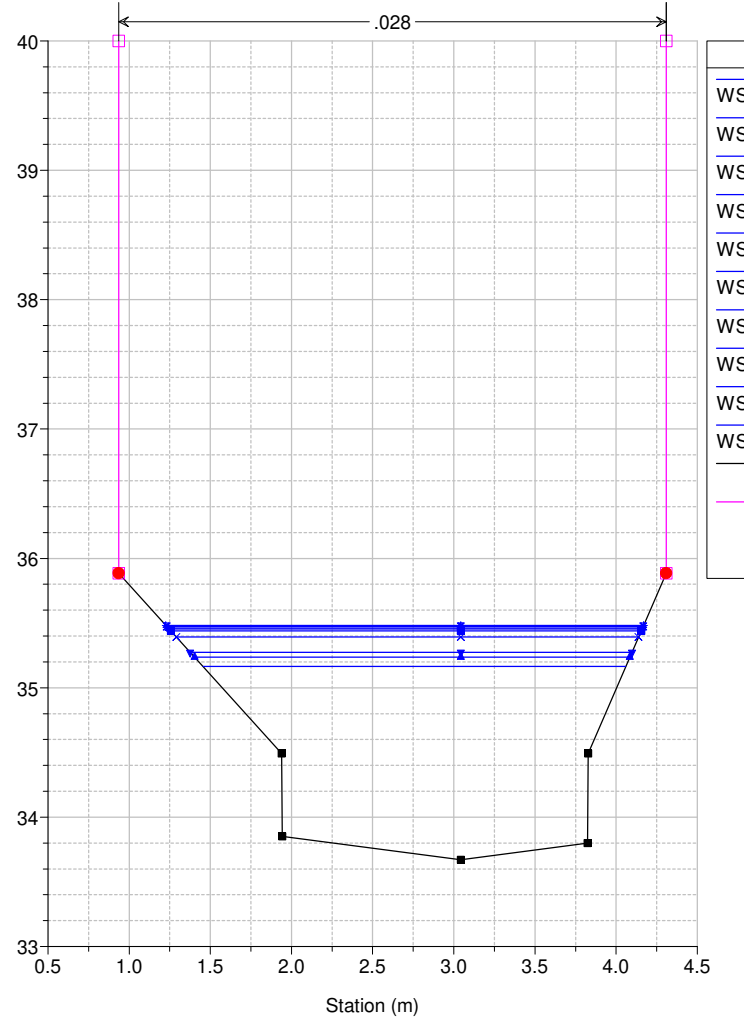

Studio Scandicci Torrenti Greve-Vingone
River = Fosso Dogaia Reach = Dogaia_02 RS = 26.5 BR

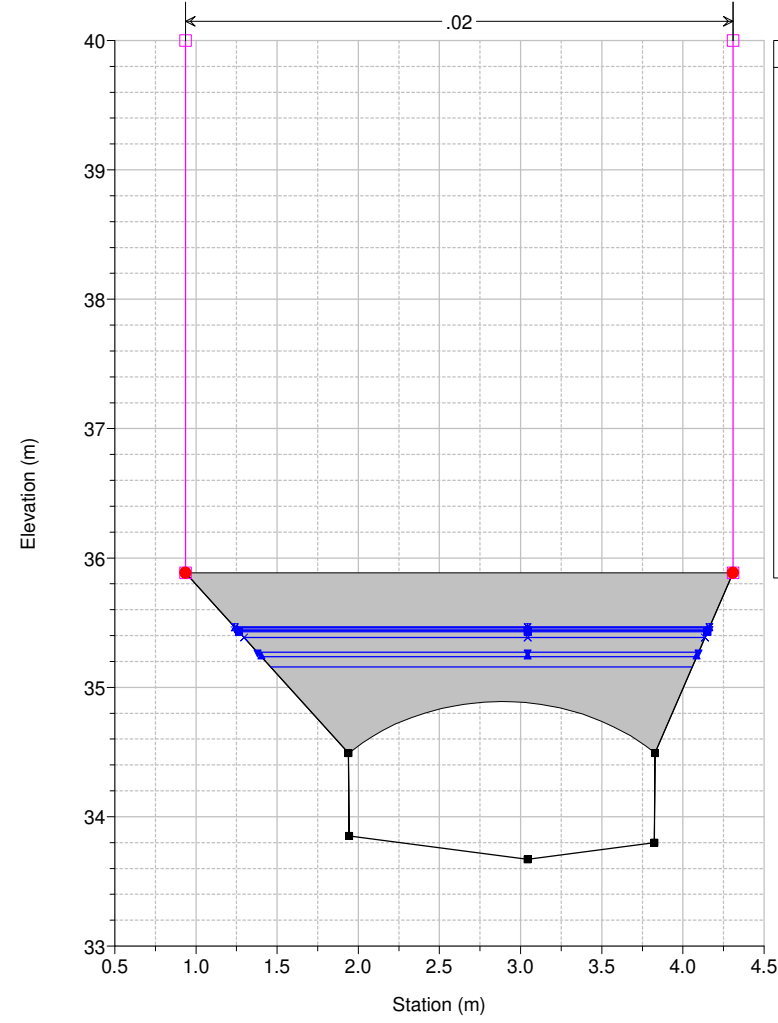

Legend	
WS Max WS - TR030_18_0	+
WS Max WS - TR030_12_0	x
WS Max WS - TR030_24_0	*
WS Max WS - TR030_09_0	•
WS Max WS - TR030_36_0	■
WS Max WS - TR030_06_0	□
WS Max WS - TR030_03_0	x
WS Max WS - TR030_01_5	▼
WS Max WS - TR030_01_0	▲
WS Max WS - TR030_00_5	■
Ground	■
Levee	□
Bank Sta	•

Studio Scandicci Torrenti Greve-Vingone
River = Fosso Dogaia Reach = Dogaia_02 RS = 26.5 BR

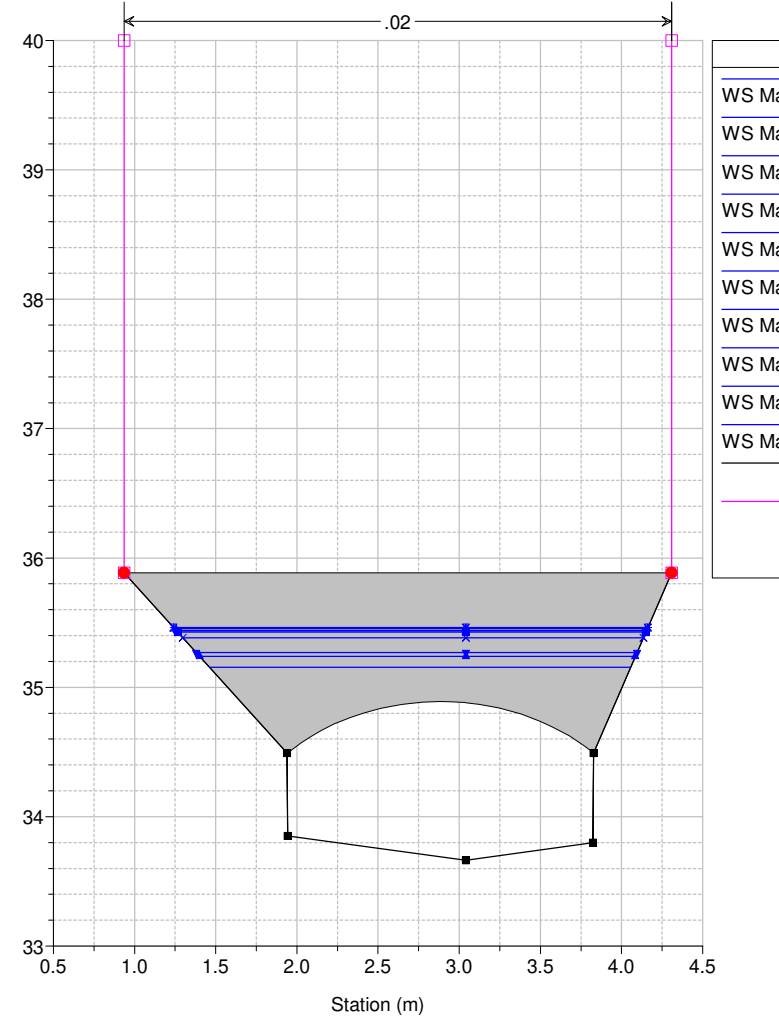

Legend	
WS Max WS - TR030_12_0	x
WS Max WS - TR030_18_0	+
WS Max WS - TR030_24_0	*
WS Max WS - TR030_09_0	•
WS Max WS - TR030_36_0	■
WS Max WS - TR030_06_0	□
WS Max WS - TR030_03_0	x
WS Max WS - TR030_01_5	▼
WS Max WS - TR030_01_0	▲
WS Max WS - TR030_00_5	■
Ground	■
Levee	□
Bank Sta	•

Studio Scandicci Torrenti Greve-Vingone
River = Fosso Dogaia Reach = Dogaia_02 RS = 26 DO1020_C

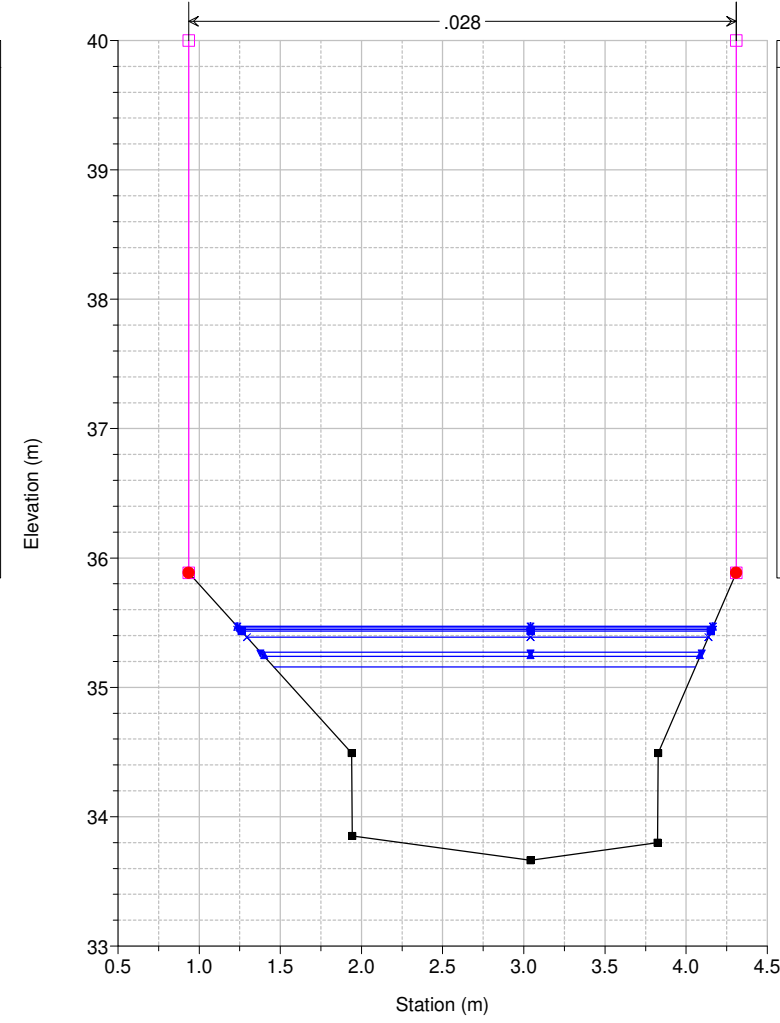

Legend	
WS Max WS - TR030_18_0	+
WS Max WS - TR030_12_0	x
WS Max WS - TR030_24_0	*
WS Max WS - TR030_09_0	•
WS Max WS - TR030_36_0	■
WS Max WS - TR030_06_0	□
WS Max WS - TR030_03_0	x
WS Max WS - TR030_01_5	▼
WS Max WS - TR030_01_0	▲
WS Max WS - TR030_00_5	■
Ground	■
Levee	□
Bank Sta	•

Studio Scandicci Torrenti Greve-Vingone
River = Fosso Dogaia Reach = Dogaia_02 RS = 25 DO1020_D

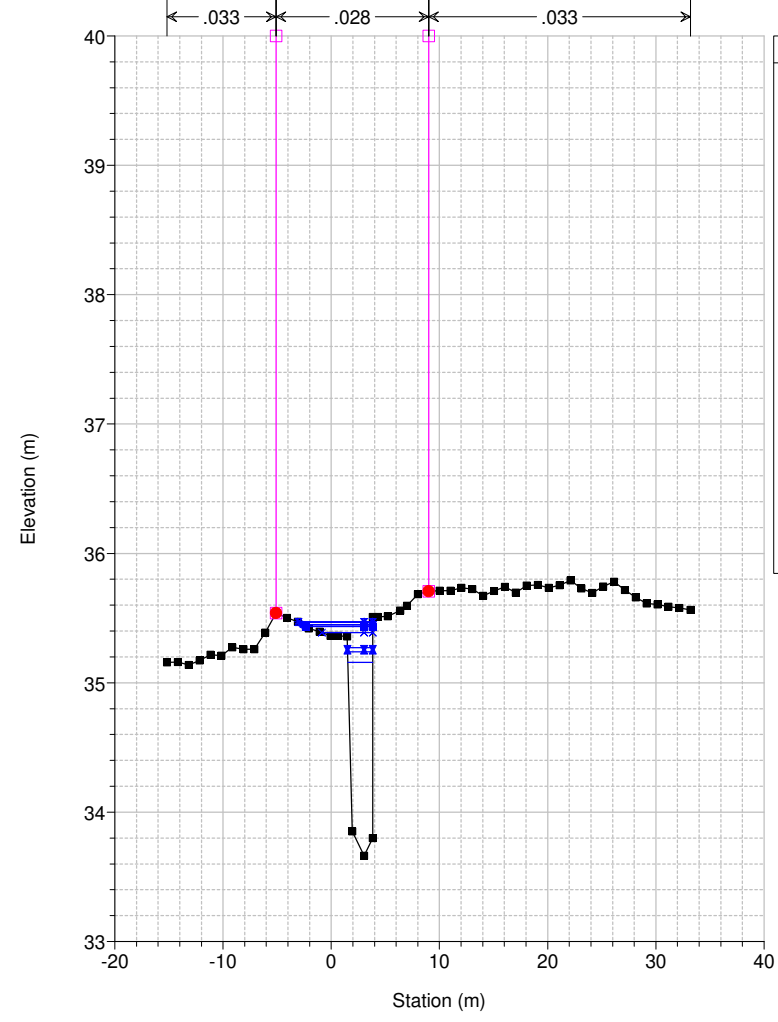

Legend	
WS Max WS - TR030_18_0	+
WS Max WS - TR030_12_0	x
WS Max WS - TR030_24_0	*
WS Max WS - TR030_36_0	•
WS Max WS - TR030_09_0	■
WS Max WS - TR030_06_0	□
WS Max WS - TR030_03_0	x
WS Max WS - TR030_01_5	▼
WS Max WS - TR030_01_0	▲
WS Max WS - TR030_00_5	■
Ground	■
Levee	□
Bank Sta	•

Studio Scandicci Torrenti Greve-Vingone
River = Fosso Dogaia Reach = Dogaia_02 RS = 24 DO0021__

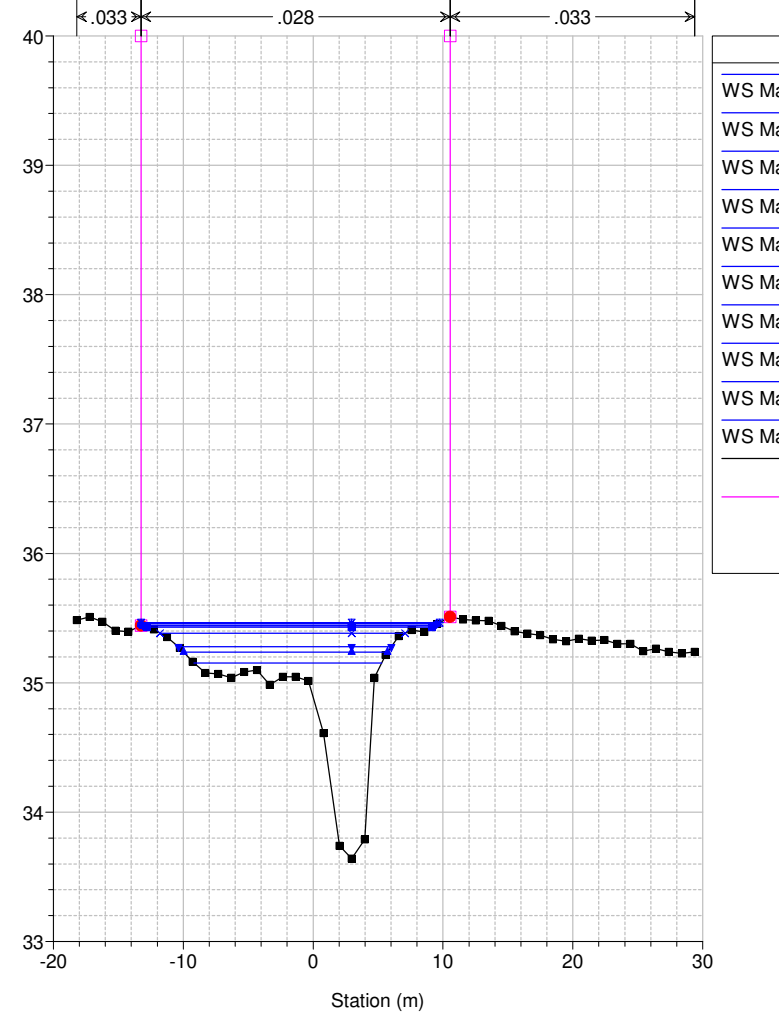

Legend	
WS Max WS - TR030_12_0	x
WS Max WS - TR030_18_0	+
WS Max WS - TR030_24_0	*
WS Max WS - TR030_09_0	•
WS Max WS - TR030_36_0	■
WS Max WS - TR030_06_0	□
WS Max WS - TR030_03_0	x
WS Max WS - TR030_01_5	▼
WS Max WS - TR030_01_0	▲
WS Max WS - TR030_00_5	■
Ground	■
Levee	□
Bank Sta	•

Studio Scandicci Torrenti Greve-Vingone
River = Fosso Dogaia Reach = Dogaia_02 RS = 23 DO1021_A

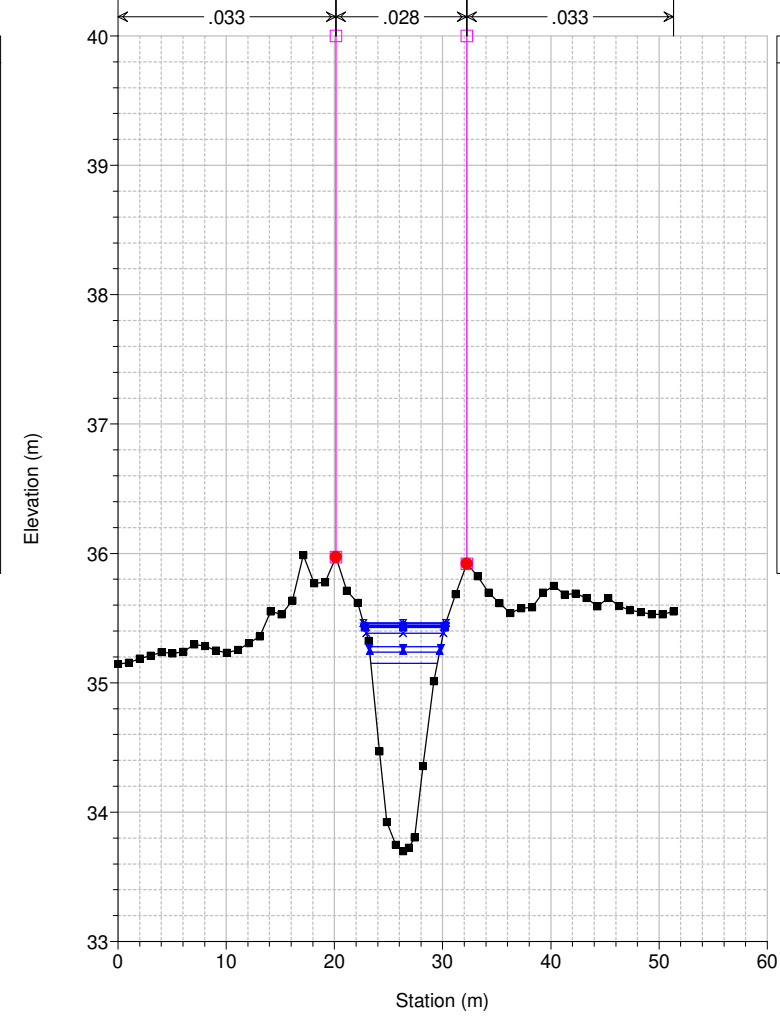

Legend	
WS Max WS - TR030_12_0	x
WS Max WS - TR030_18_0	+
WS Max WS - TR030_24_0	*
WS Max WS - TR030_09_0	•
WS Max WS - TR030_36_0	■
WS Max WS - TR030_06_0	□
WS Max WS - TR030_03_0	x
WS Max WS - TR030_01_5	▼
WS Max WS - TR030_01_0	▲
WS Max WS - TR030_00_5	■
Ground	■
Levee	□
Bank Sta	•

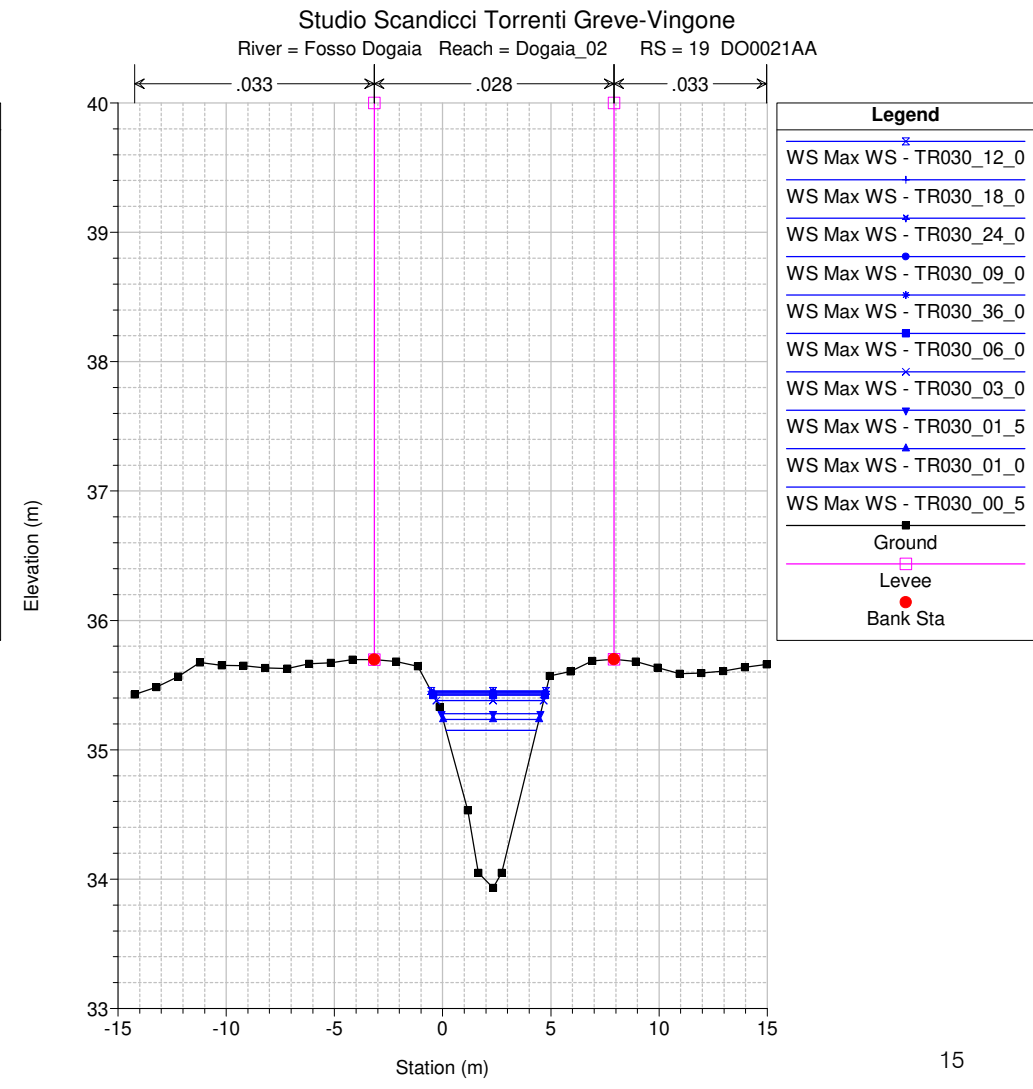
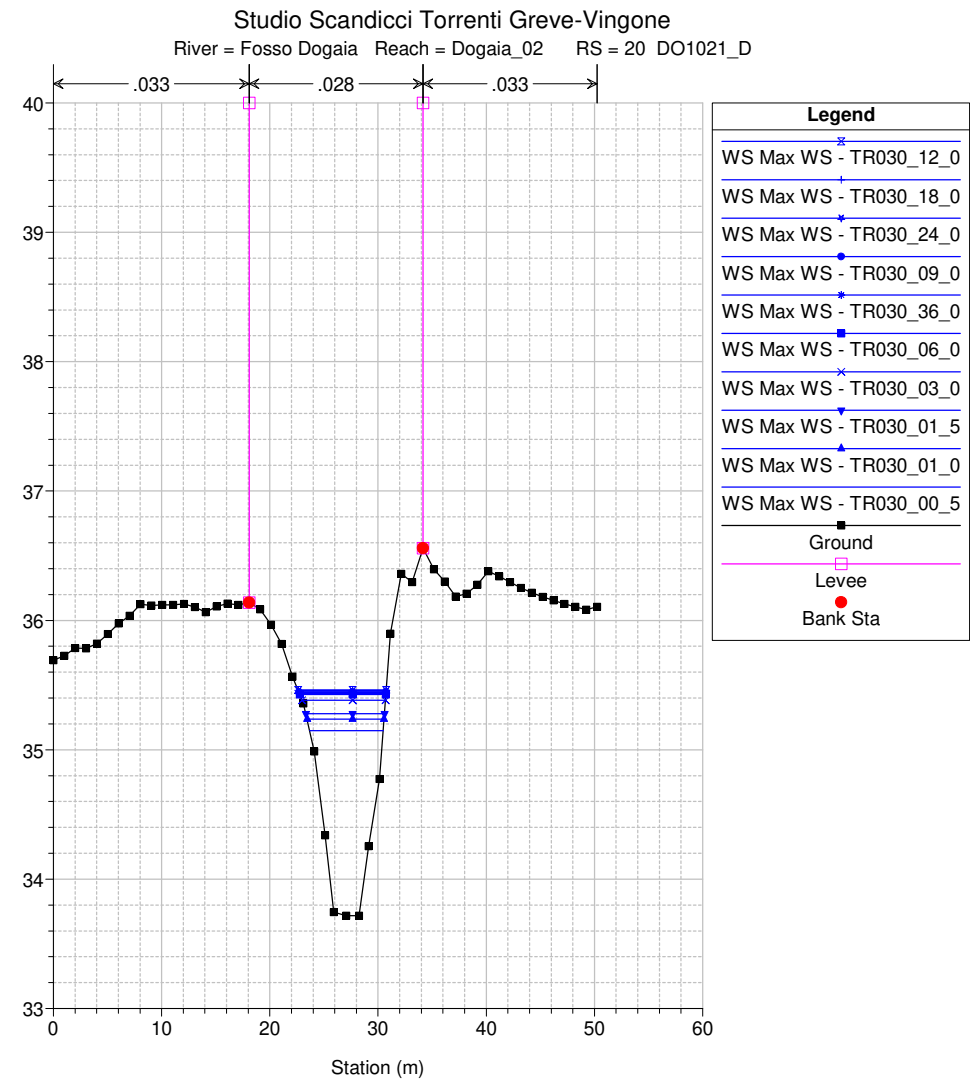
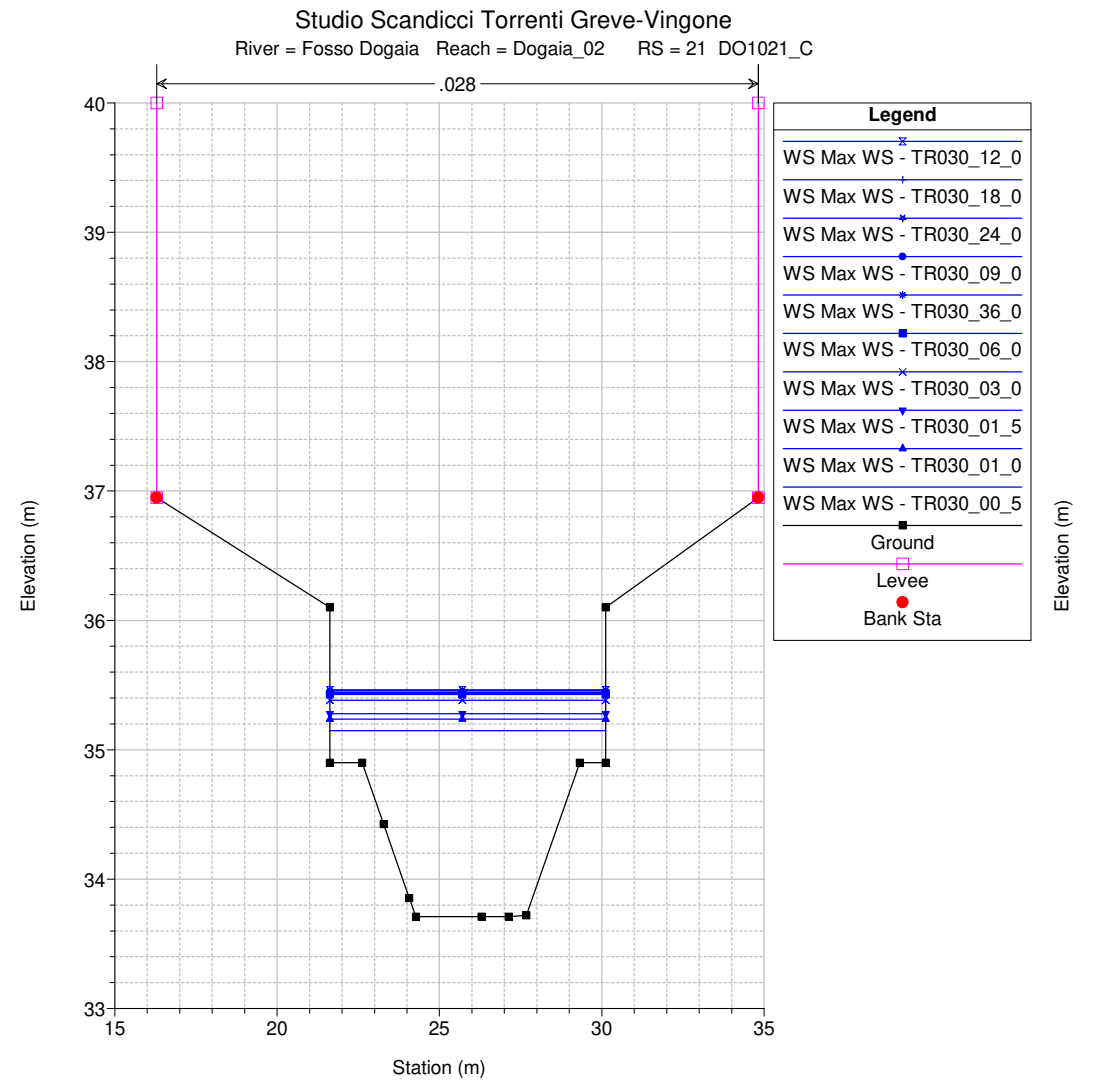
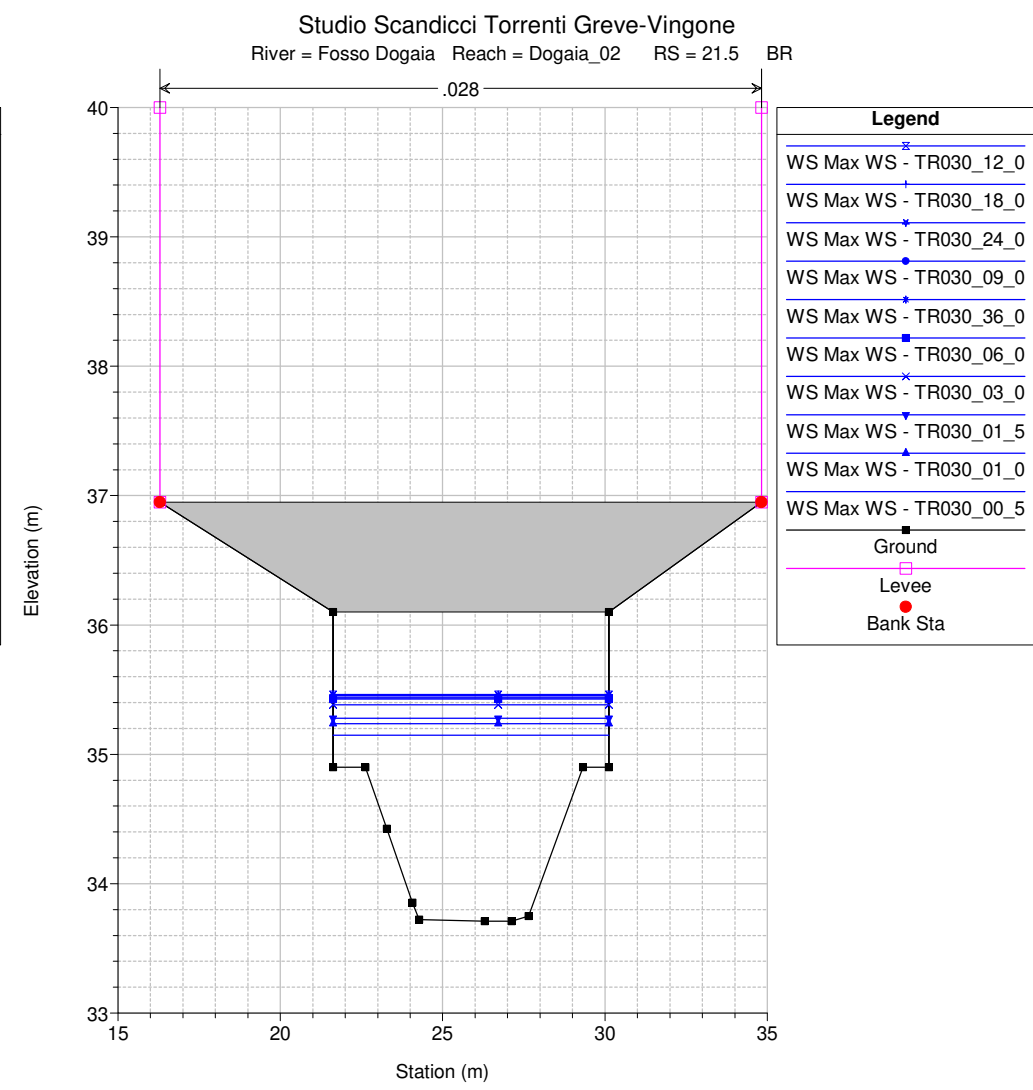
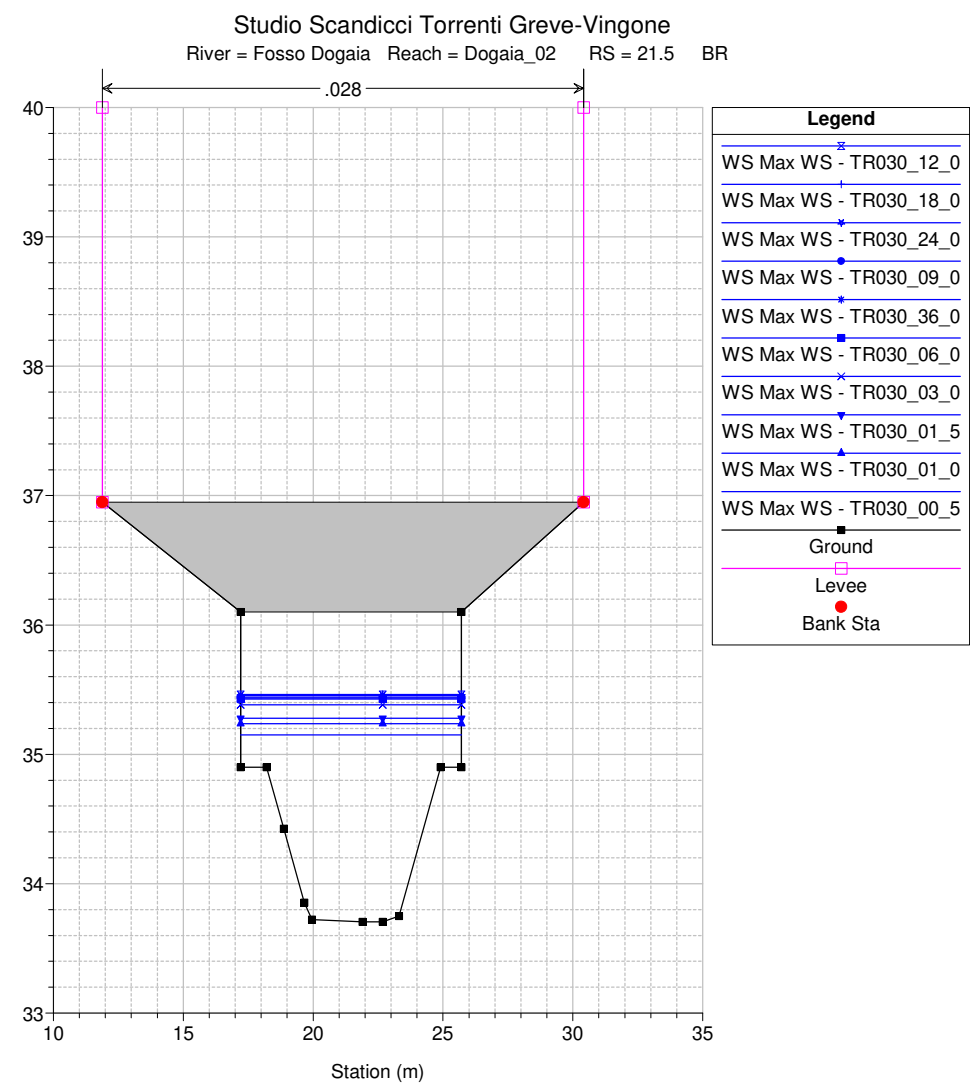
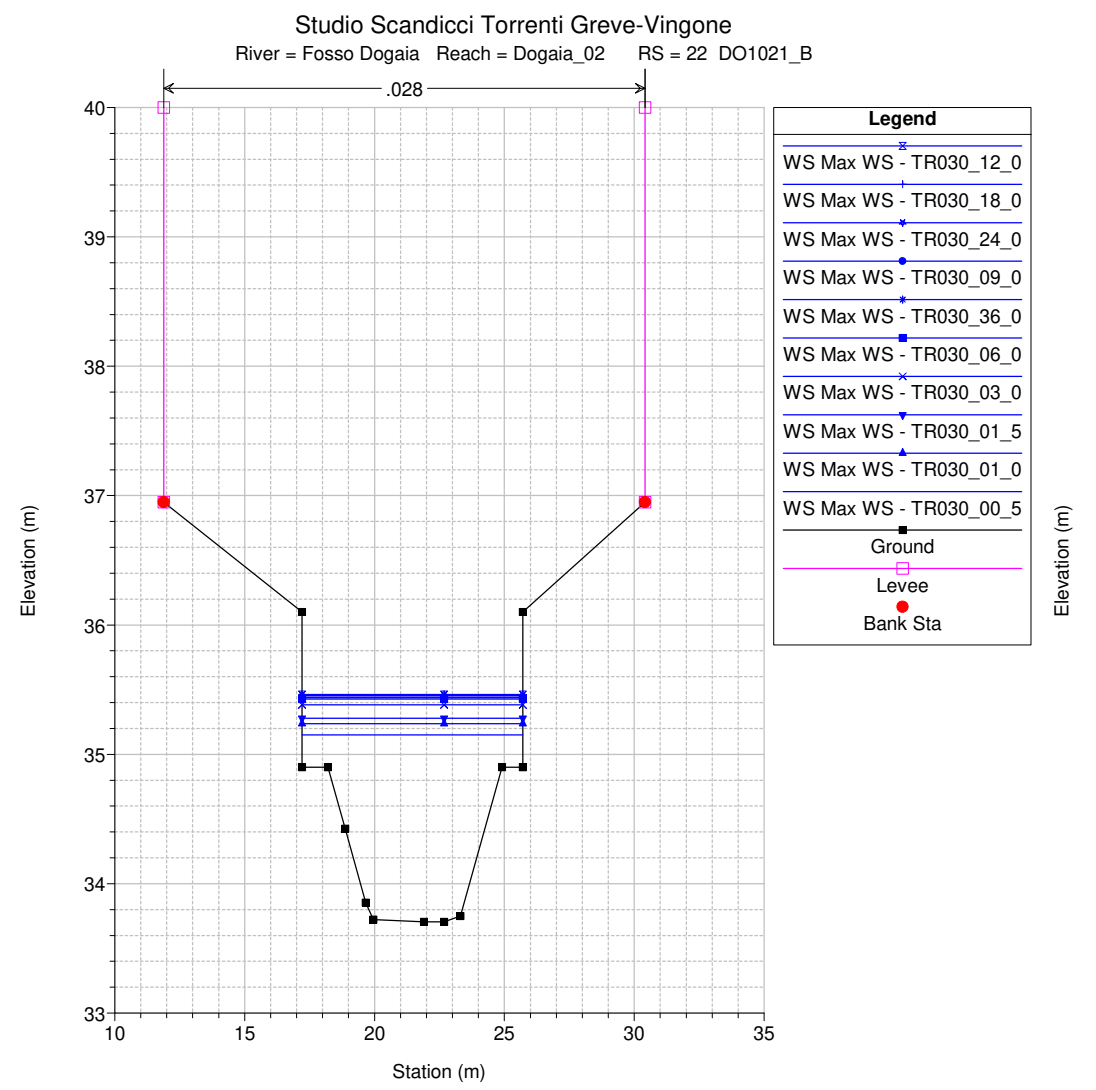

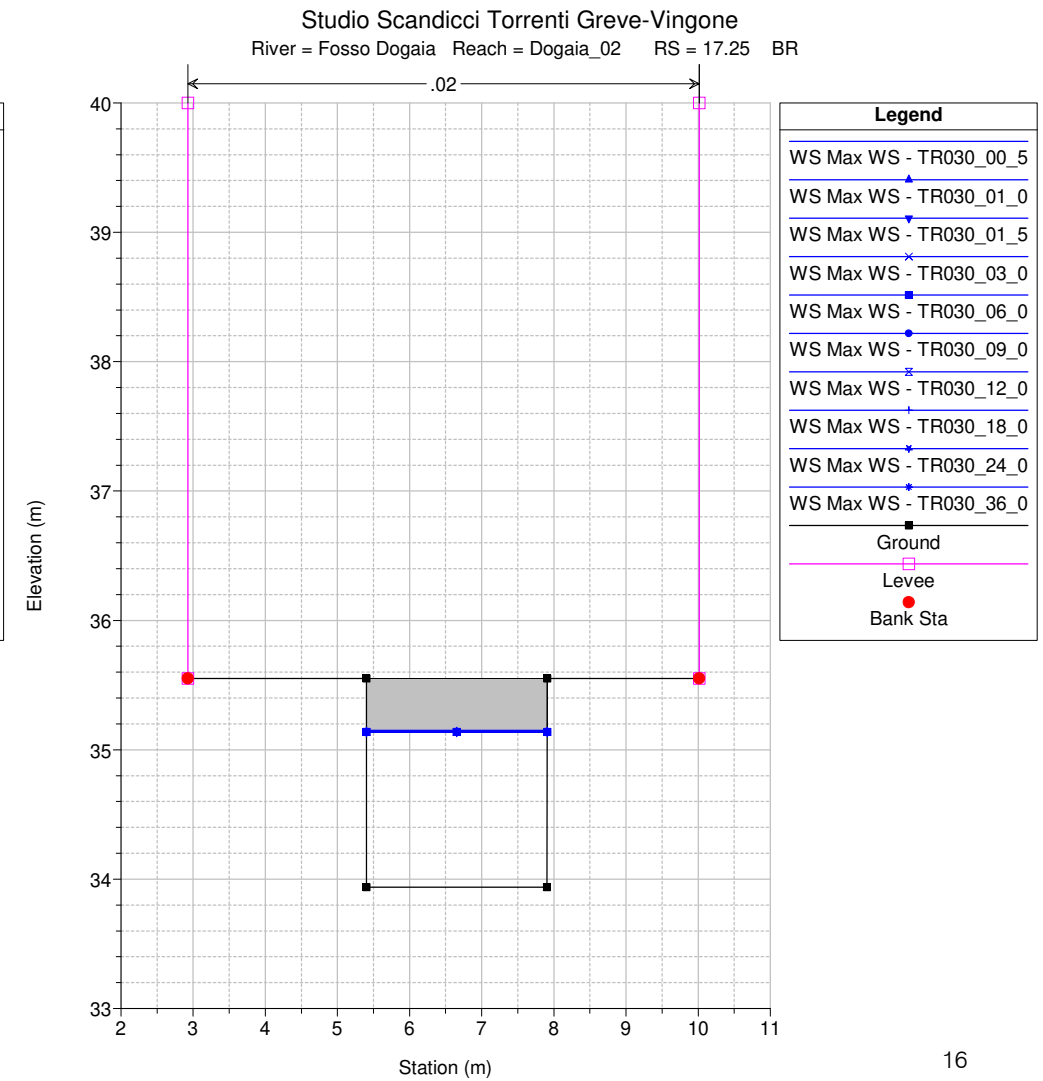
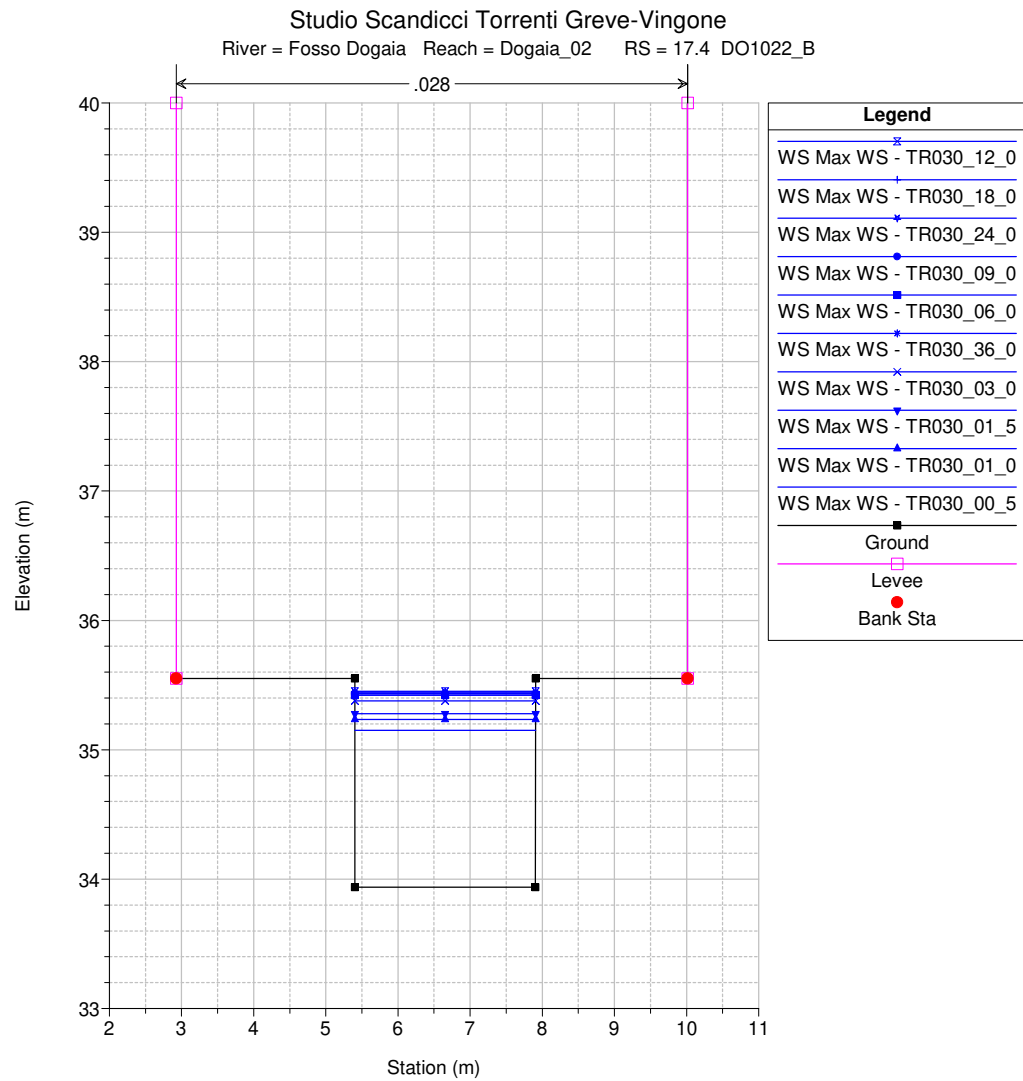
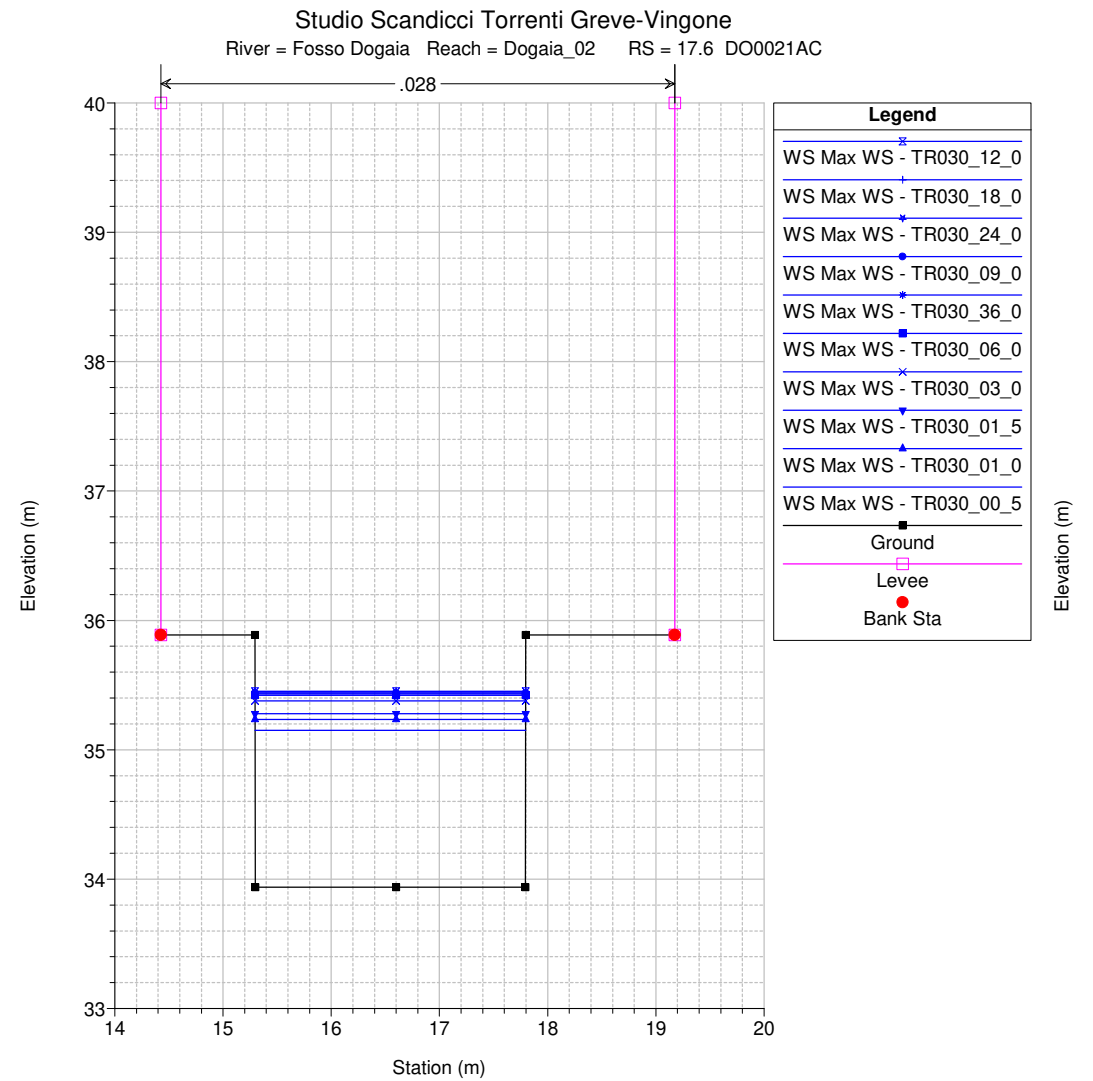
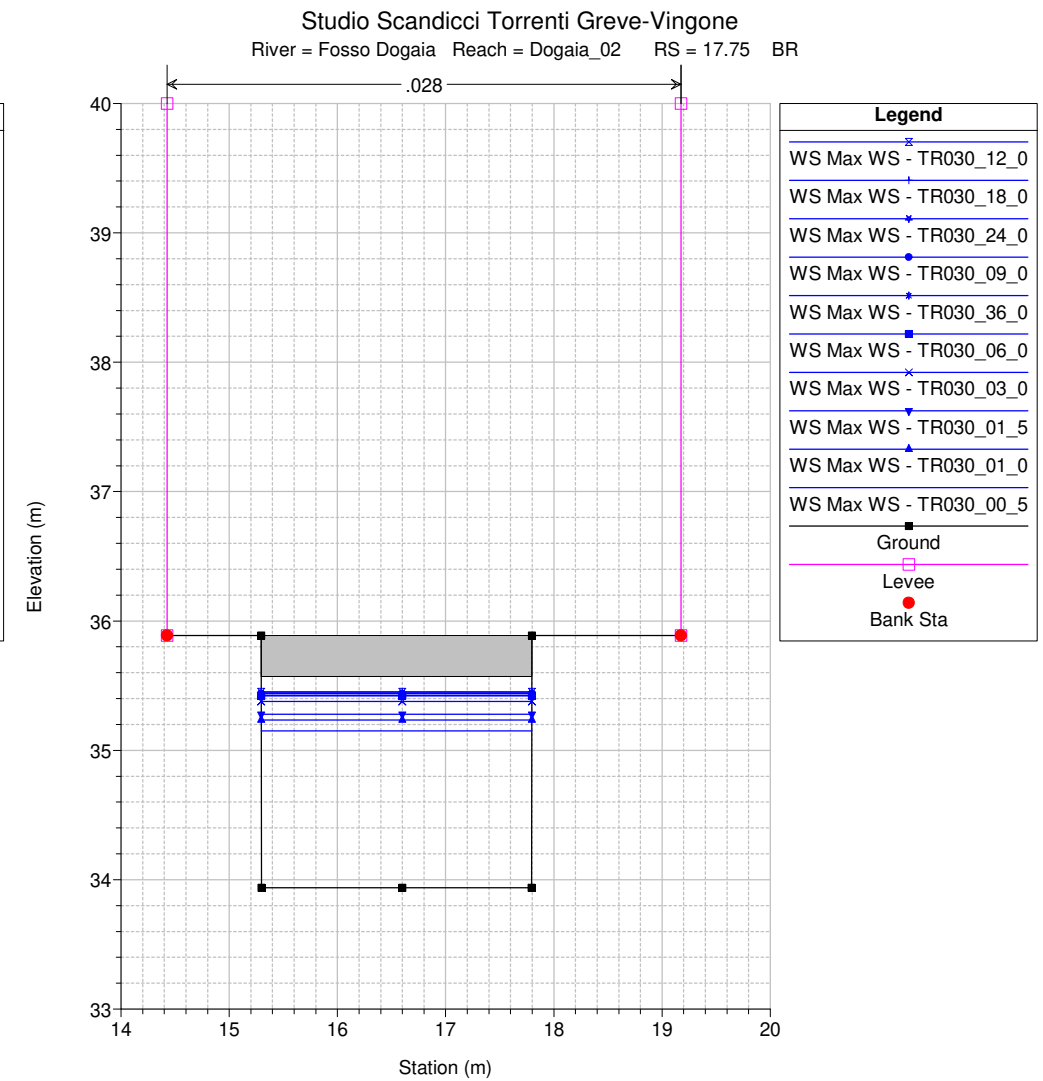
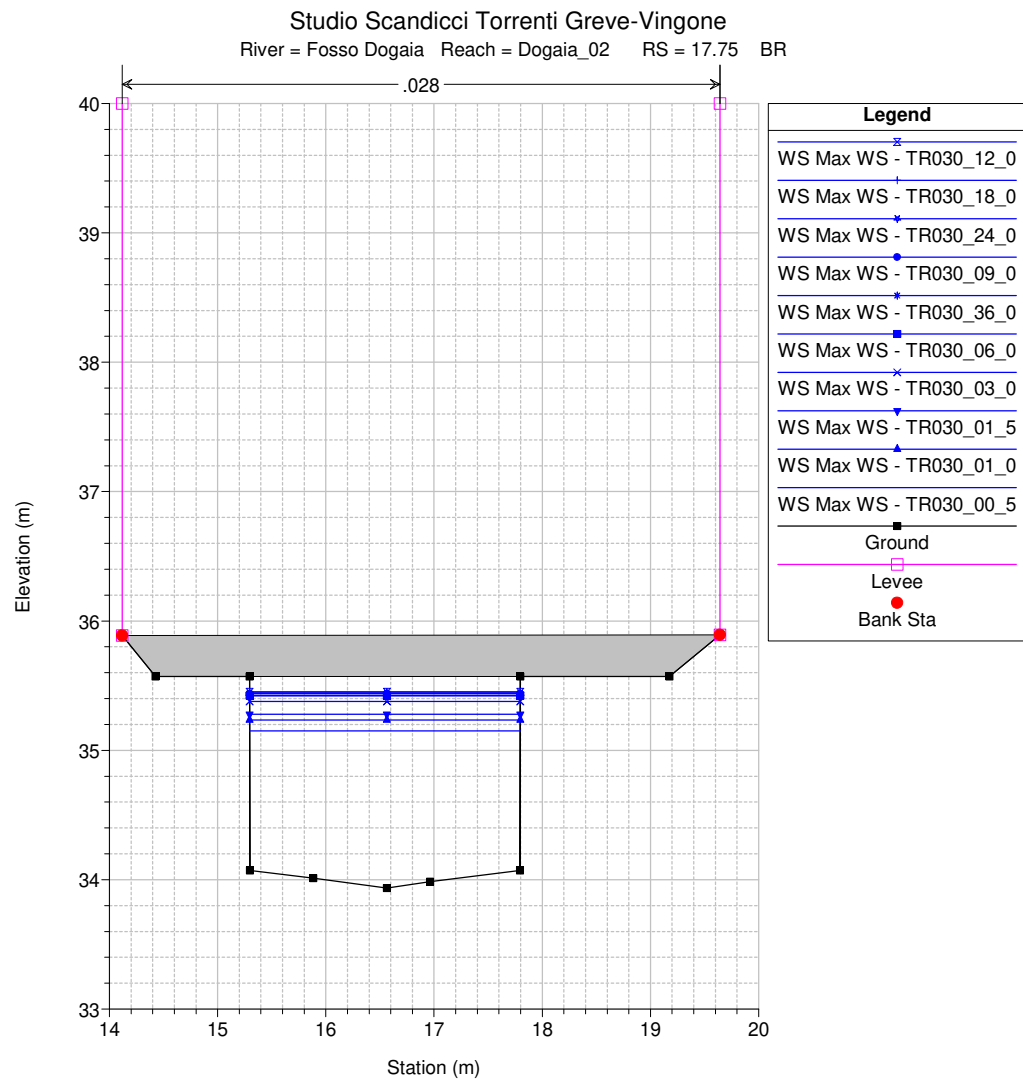
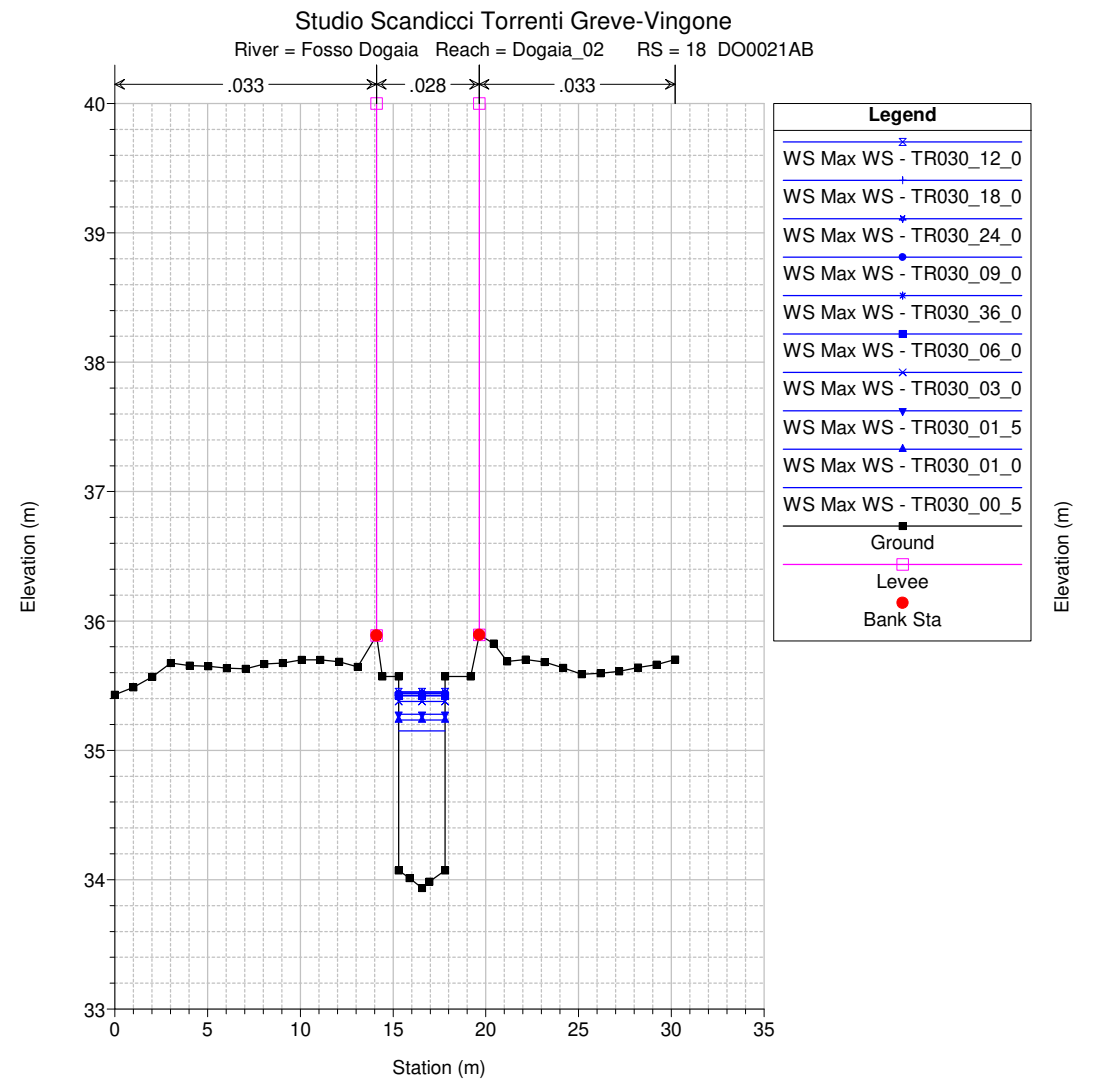

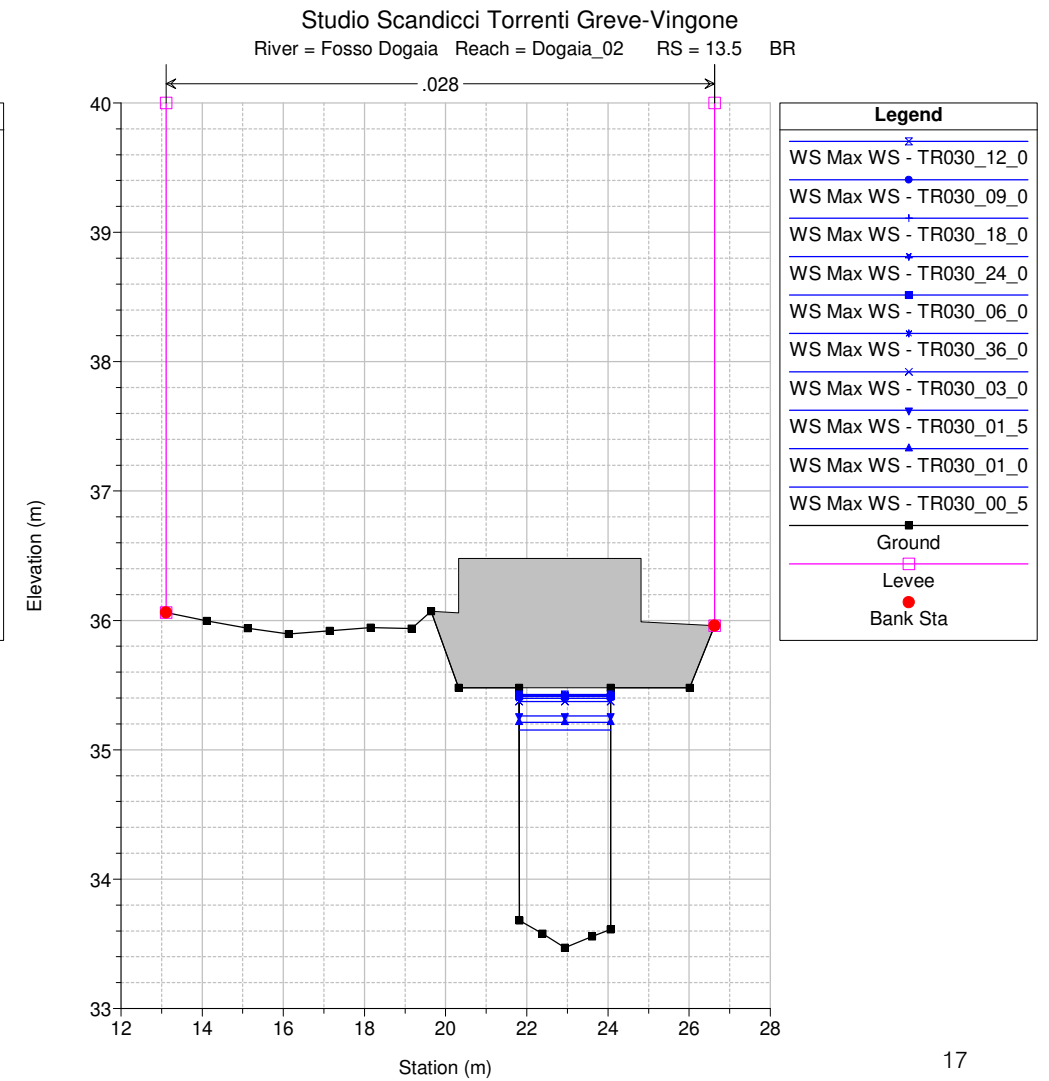
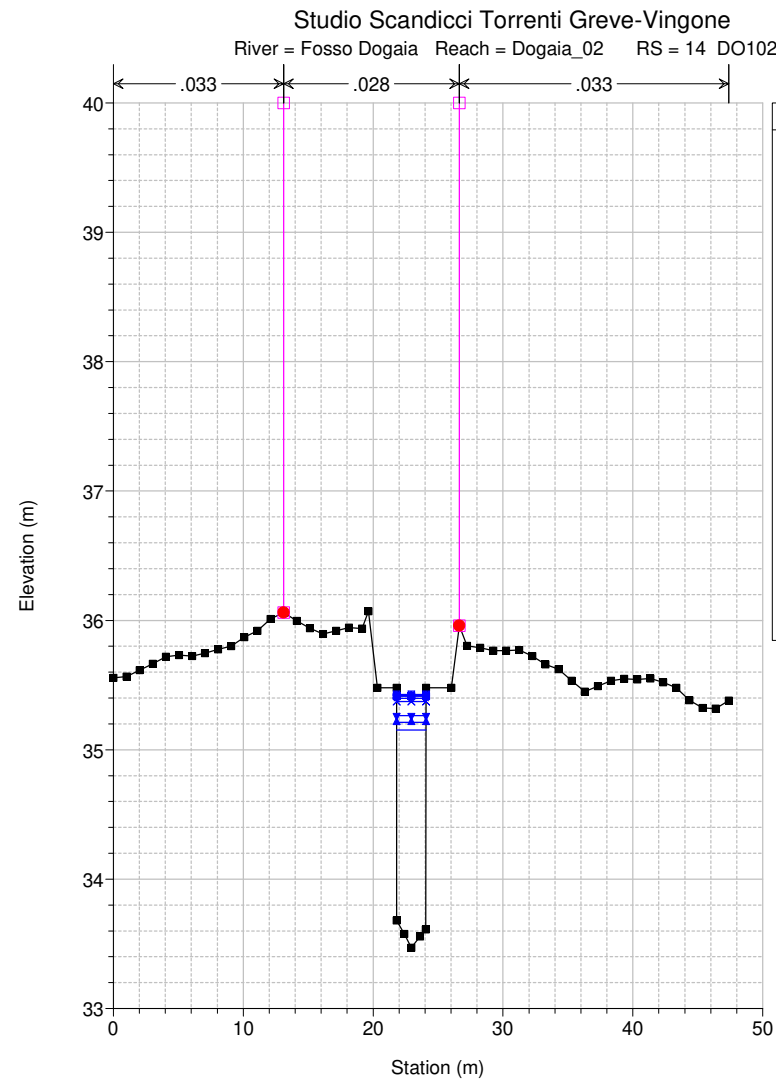
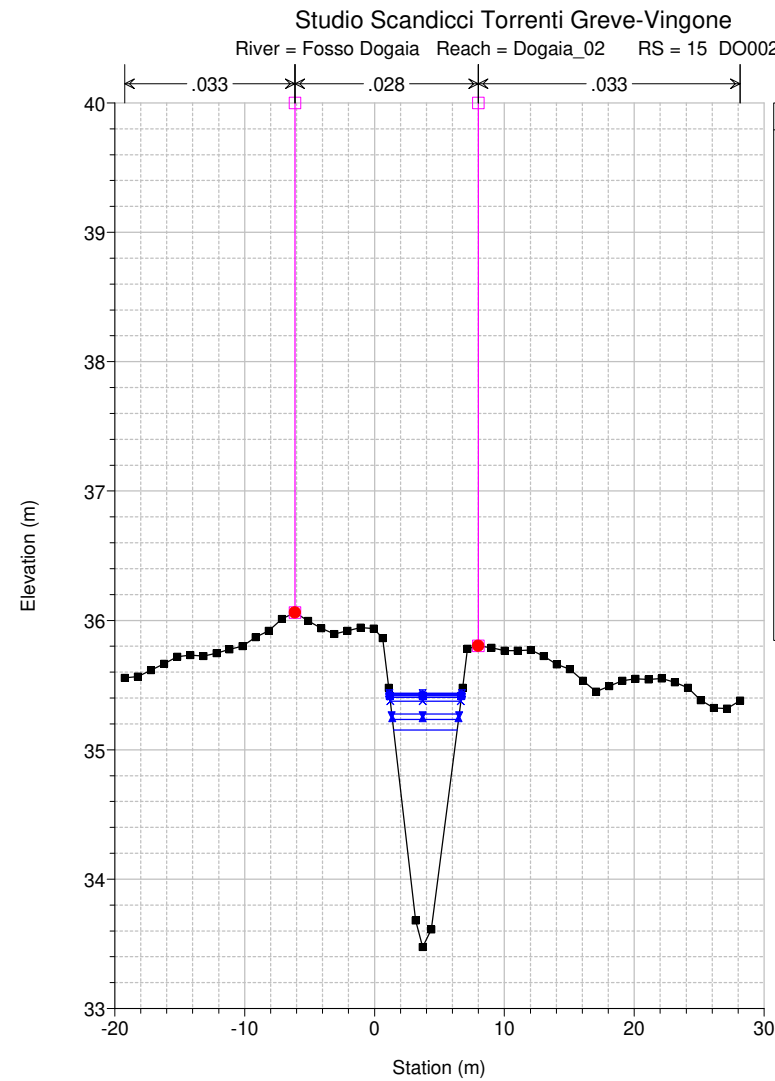
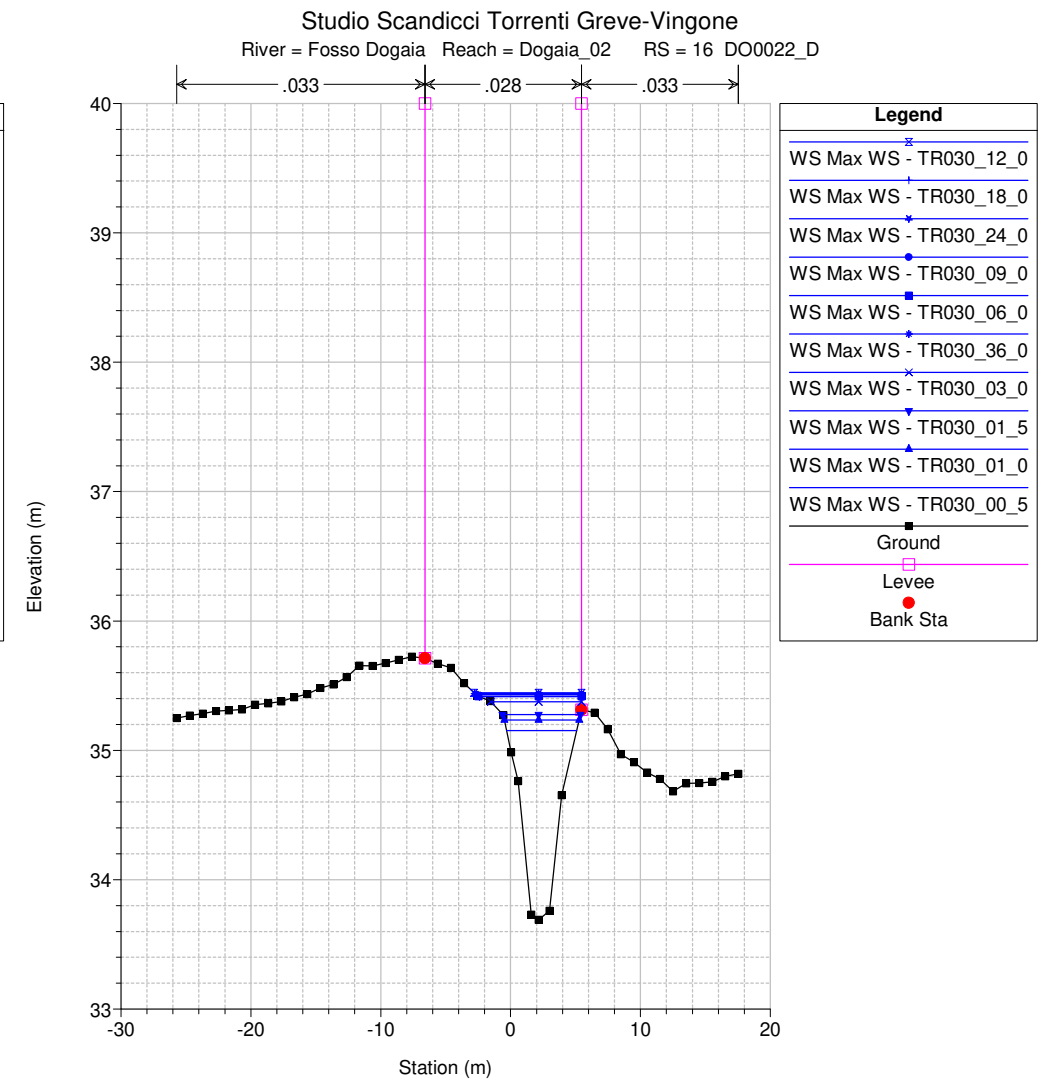
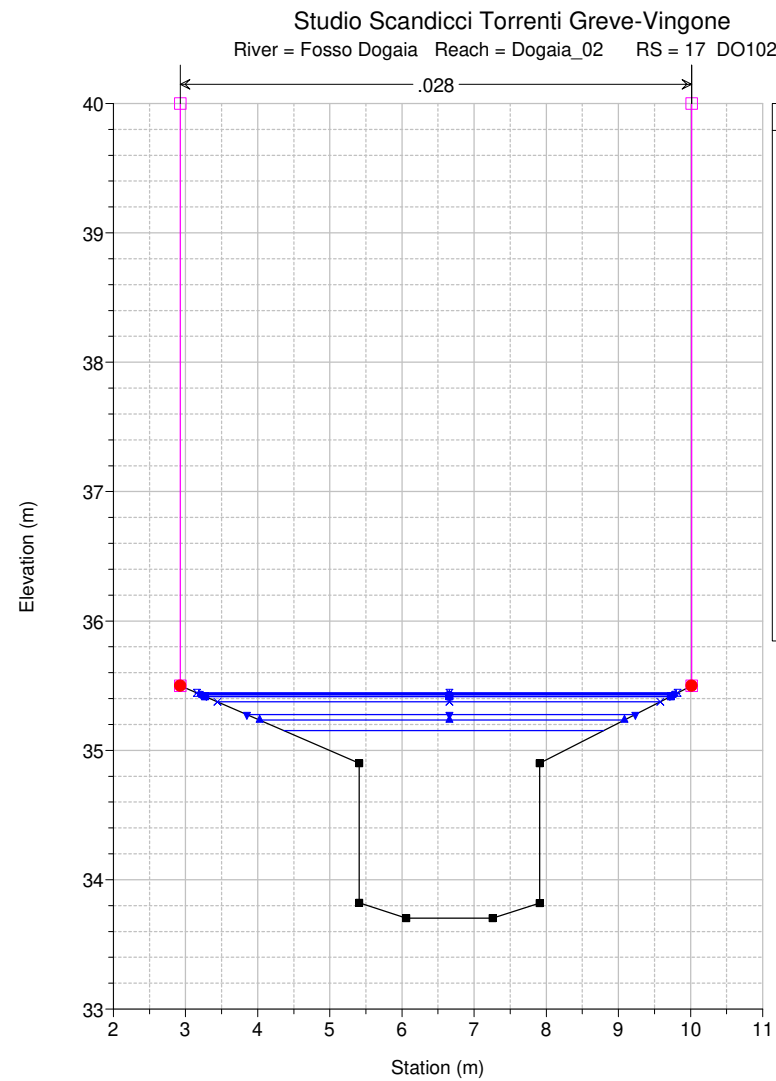
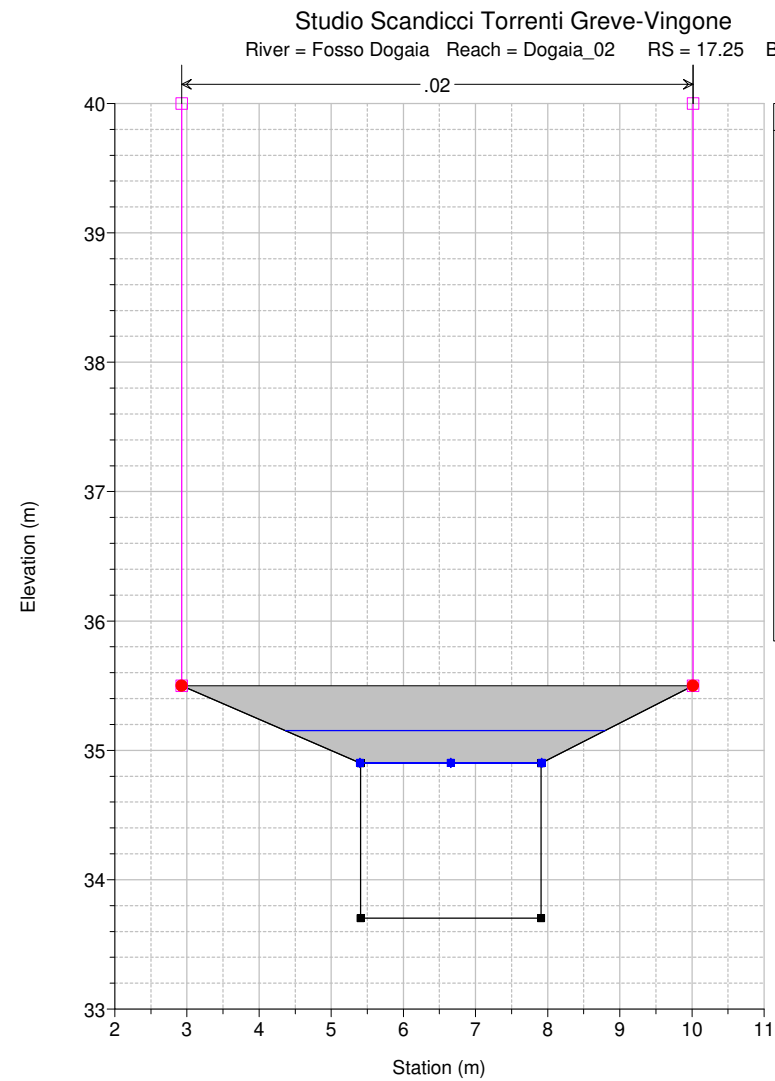

Studio Scandicci Torrenti Greve-Vingone
River = Fosso Dogaia Reach = Dogaia_02 RS = 13.5 BR

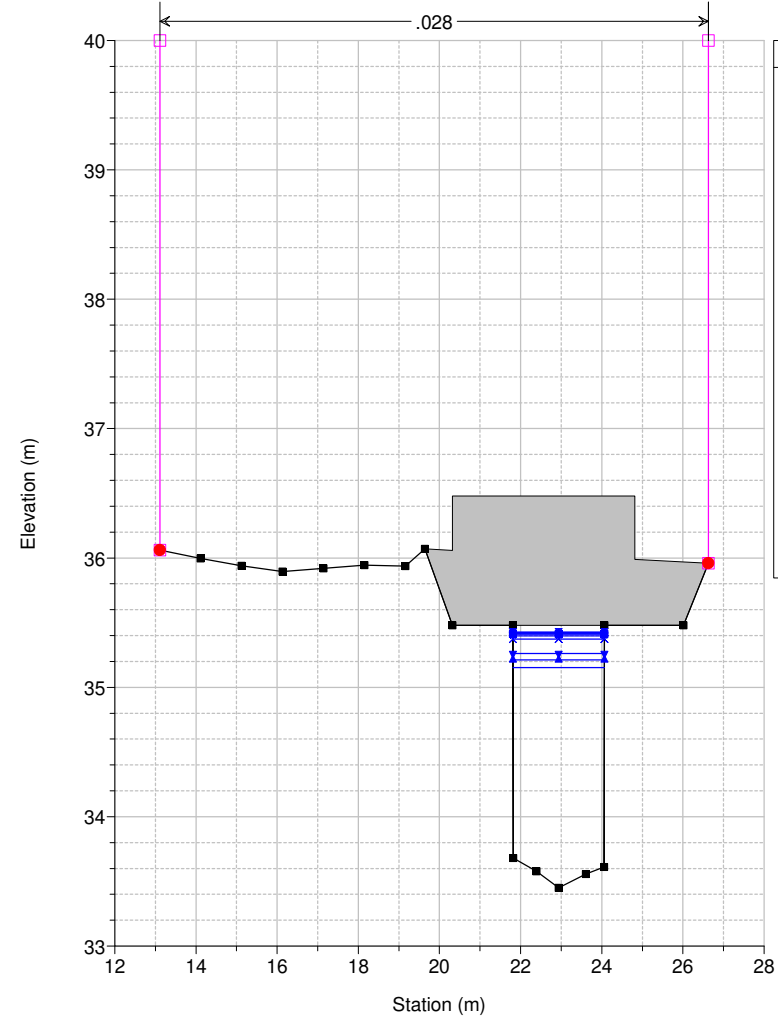

Legend	
WS Max WS - TR030_12_0	✕
WS Max WS - TR030_09_0	•
WS Max WS - TR030_18_0	+
WS Max WS - TR030_06_0	■
WS Max WS - TR030_24_0	▲
WS Max WS - TR030_36_0	◆
WS Max WS - TR030_03_0	✖
WS Max WS - TR030_01_5	▼
WS Max WS - TR030_01_0	▲
WS Max WS - TR030_00_5	▲
Ground	■
Levee	□
Bank Sta	•

Studio Scandicci Torrenti Greve-Vingone
River = Fosso Dogaia Reach = Dogaia_02 RS = 13 DO1023_C

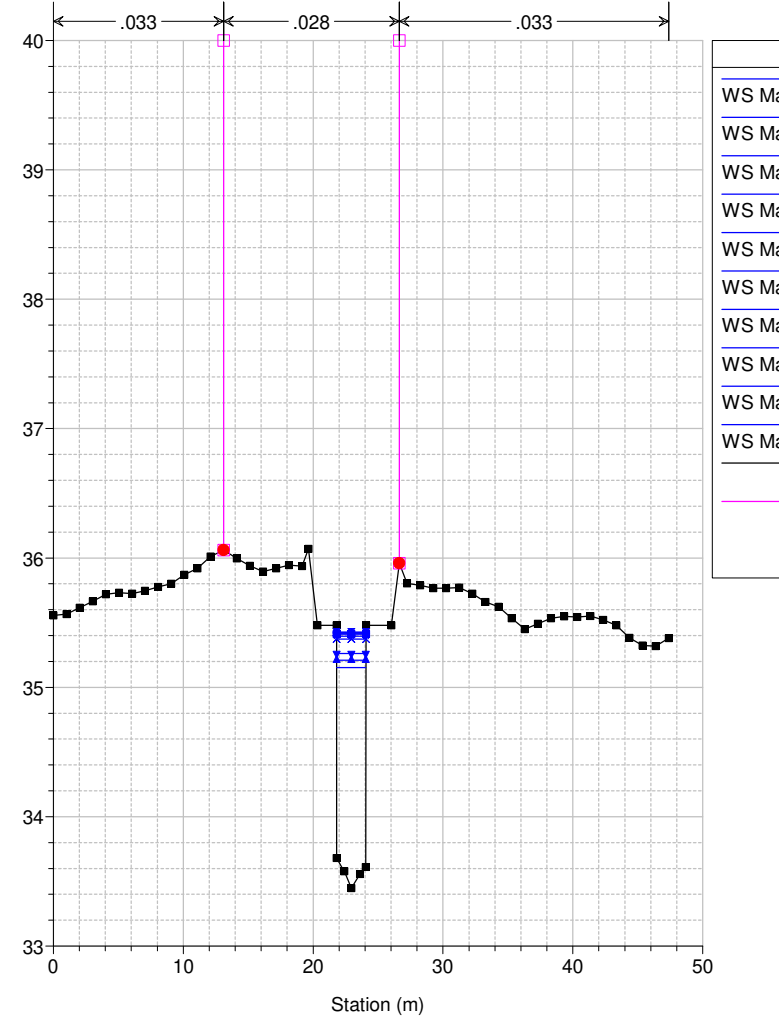

Legend	
WS Max WS - TR030_12_0	✕
WS Max WS - TR030_09_0	•
WS Max WS - TR030_18_0	+
WS Max WS - TR030_06_0	■
WS Max WS - TR030_24_0	▲
WS Max WS - TR030_36_0	◆
WS Max WS - TR030_03_0	✖
WS Max WS - TR030_01_5	▼
WS Max WS - TR030_01_0	▲
WS Max WS - TR030_00_5	▲
Ground	■
Levee	□
Bank Sta	•

Studio Scandicci Torrenti Greve-Vingone
River = Fosso Dogaia Reach = Dogaia_02 RS = 12 DO0023_D

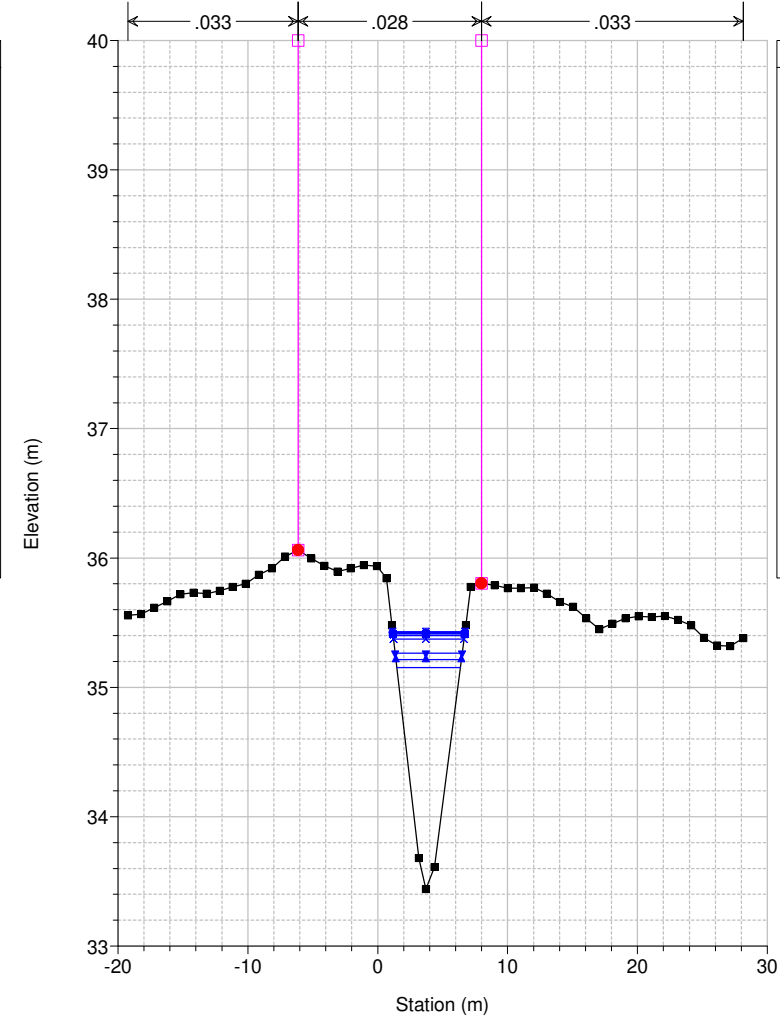

Legend	
WS Max WS - TR030_12_0	✕
WS Max WS - TR030_18_0	+
WS Max WS - TR030_09_0	•
WS Max WS - TR030_24_0	▲
WS Max WS - TR030_06_0	■
WS Max WS - TR030_36_0	◆
WS Max WS - TR030_03_0	✖
WS Max WS - TR030_01_5	▼
WS Max WS - TR030_01_0	▲
WS Max WS - TR030_00_5	▲
Ground	■
Levee	□
Bank Sta	•

Studio Scandicci Torrenti Greve-Vingone
River = Fosso Dogaia Reach = Dogaia_02 RS = 11 DO0024_A

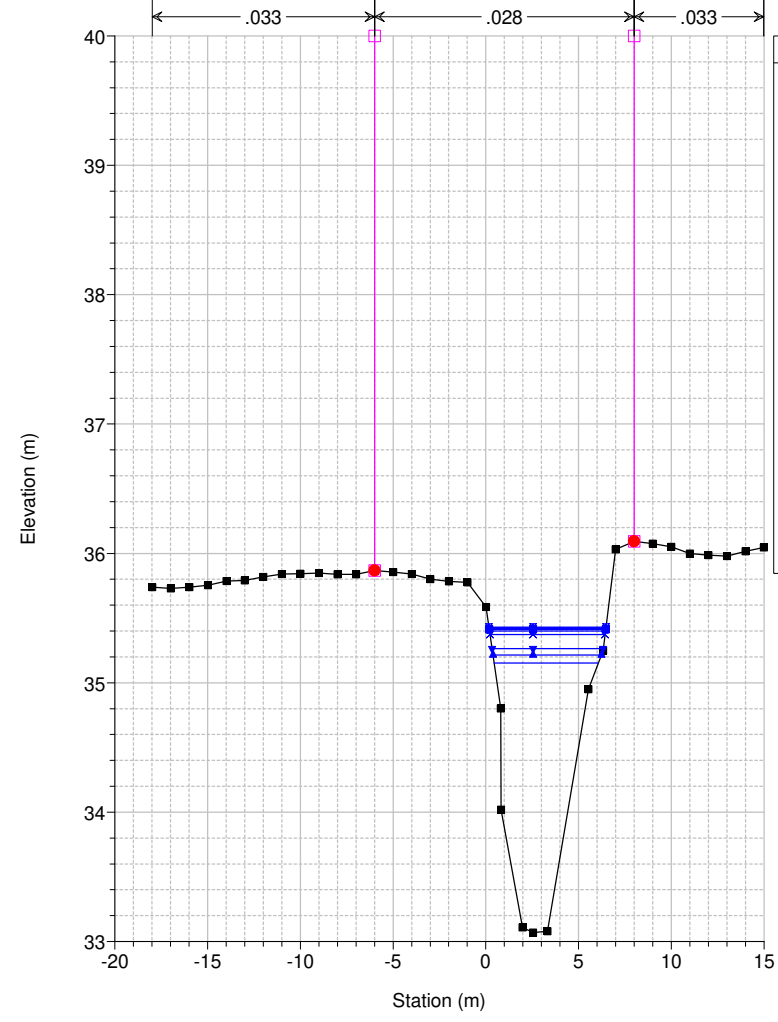

Legend	
WS Max WS - TR030_12_0	✕
WS Max WS - TR030_18_0	+
WS Max WS - TR030_09_0	•
WS Max WS - TR030_24_0	▲
WS Max WS - TR030_06_0	■
WS Max WS - TR030_36_0	◆
WS Max WS - TR030_03_0	✖
WS Max WS - TR030_01_5	▼
WS Max WS - TR030_01_0	▲
WS Max WS - TR030_00_5	▲
Ground	■
Levee	□
Bank Sta	•

Studio Scandicci Torrenti Greve-Vingone
River = Fosso Dogaia Reach = Dogaia_02 RS = 10 DO0024_B

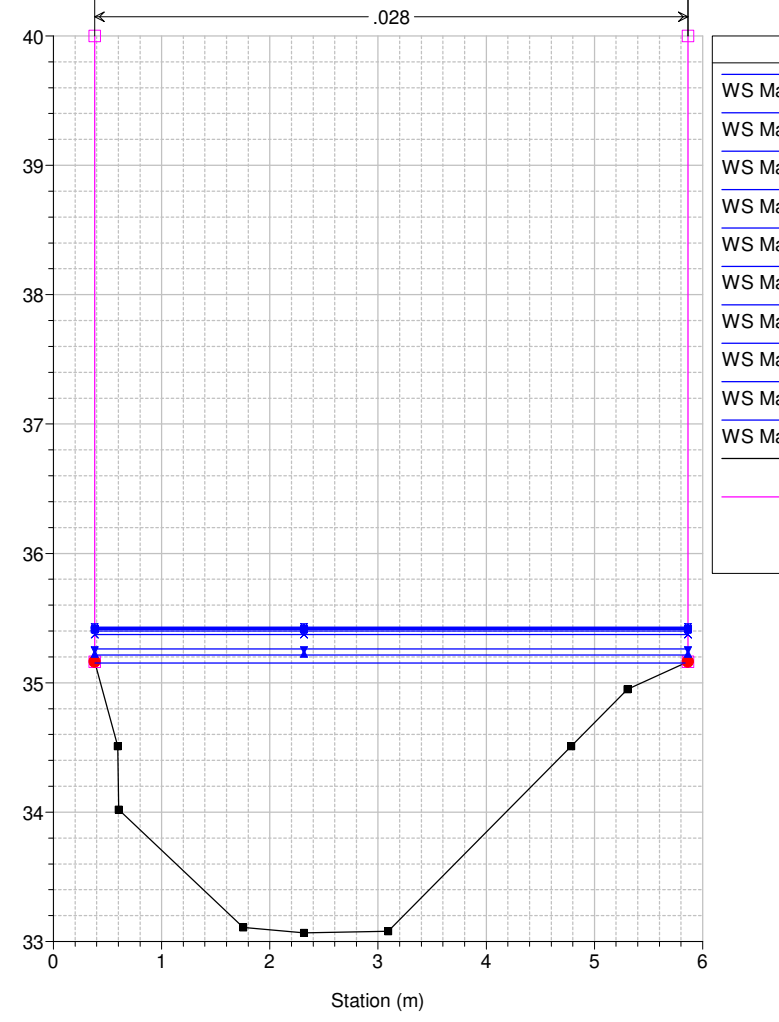

Legend	
WS Max WS - TR030_12_0	✕
WS Max WS - TR030_18_0	+
WS Max WS - TR030_09_0	•
WS Max WS - TR030_24_0	▲
WS Max WS - TR030_06_0	■
WS Max WS - TR030_36_0	◆
WS Max WS - TR030_03_0	✖
WS Max WS - TR030_01_5	▼
WS Max WS - TR030_01_0	▲
WS Max WS - TR030_00_5	▲
Ground	■
Levee	□
Bank Sta	•

Studio Scandicci Torrenti Greve-Vingone
River = Fosso Dogaia Reach = Dogaia_02 RS = 9.5 BR

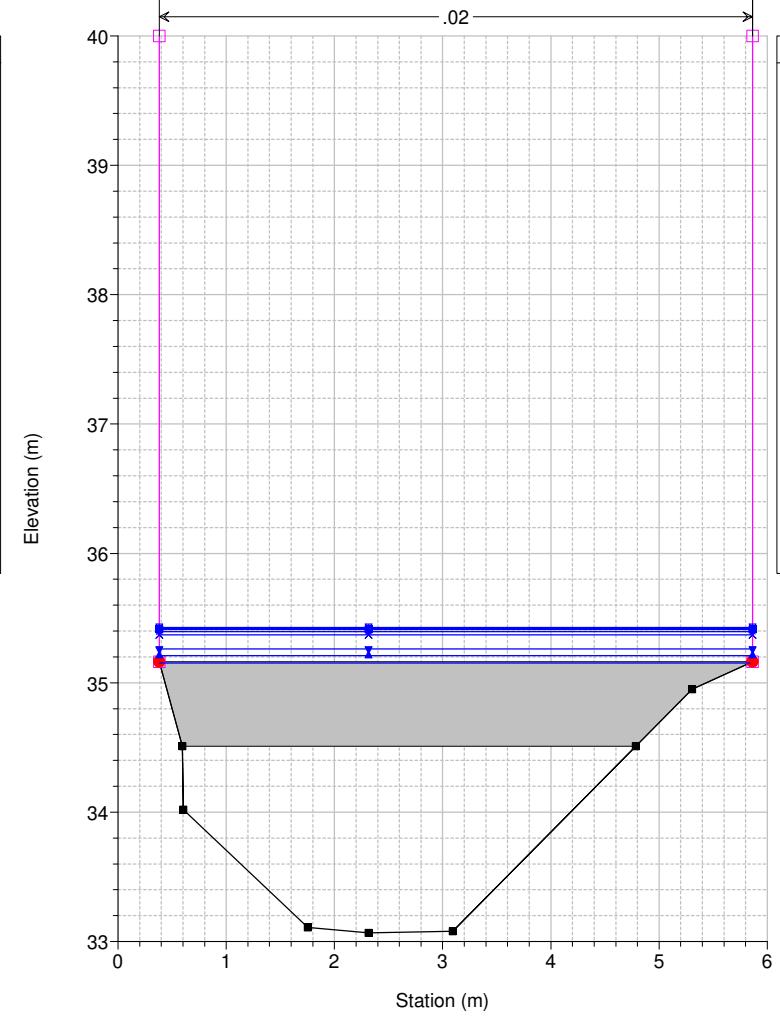

Legend	
WS Max WS - TR030_12_0	✕
WS Max WS - TR030_18_0	+
WS Max WS - TR030_09_0	•
WS Max WS - TR030_24_0	▲
WS Max WS - TR030_06_0	■
WS Max WS - TR030_36_0	◆
WS Max WS - TR030_03_0	✖
WS Max WS - TR030_01_5	▼
WS Max WS - TR030_01_0	▲
WS Max WS - TR030_00_5	▲
Ground	■
Levee	□
Bank Sta	•

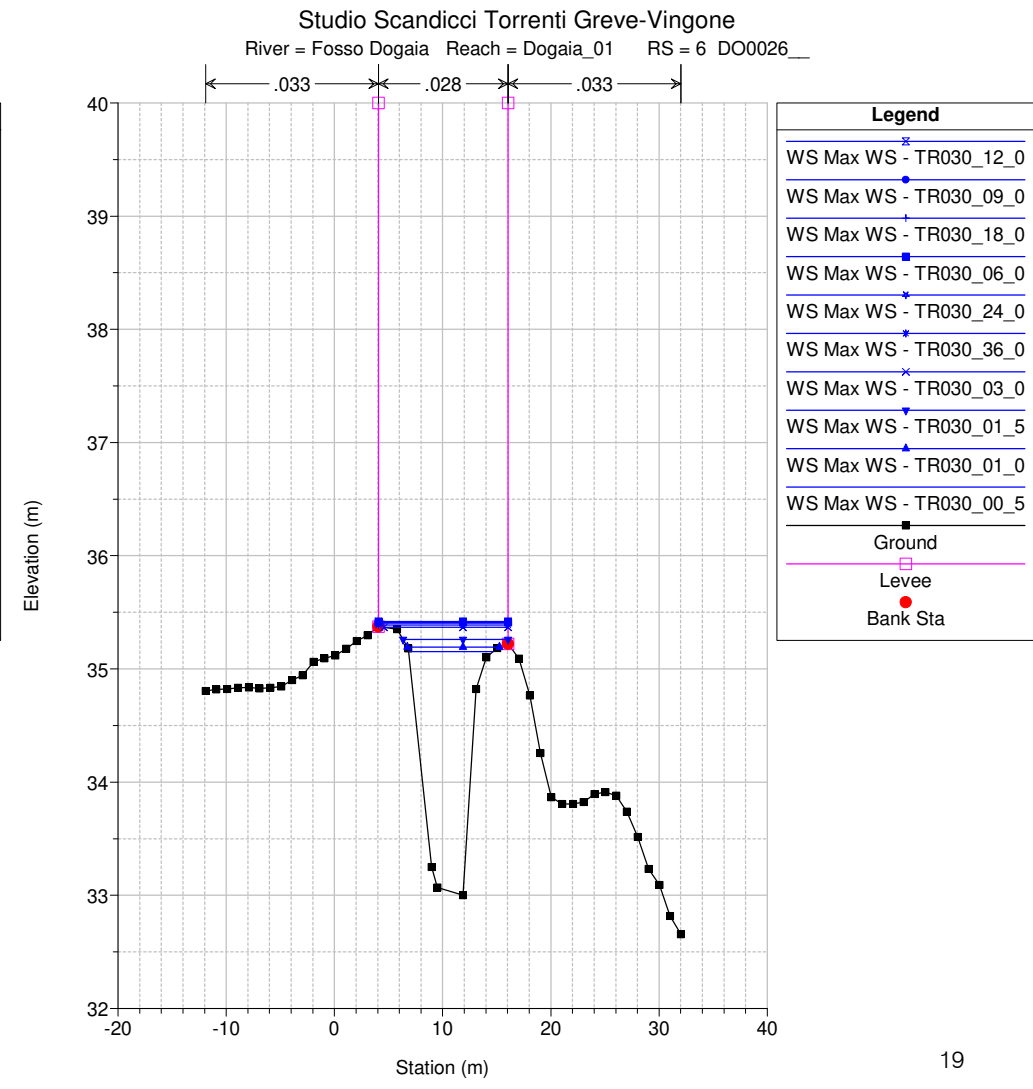
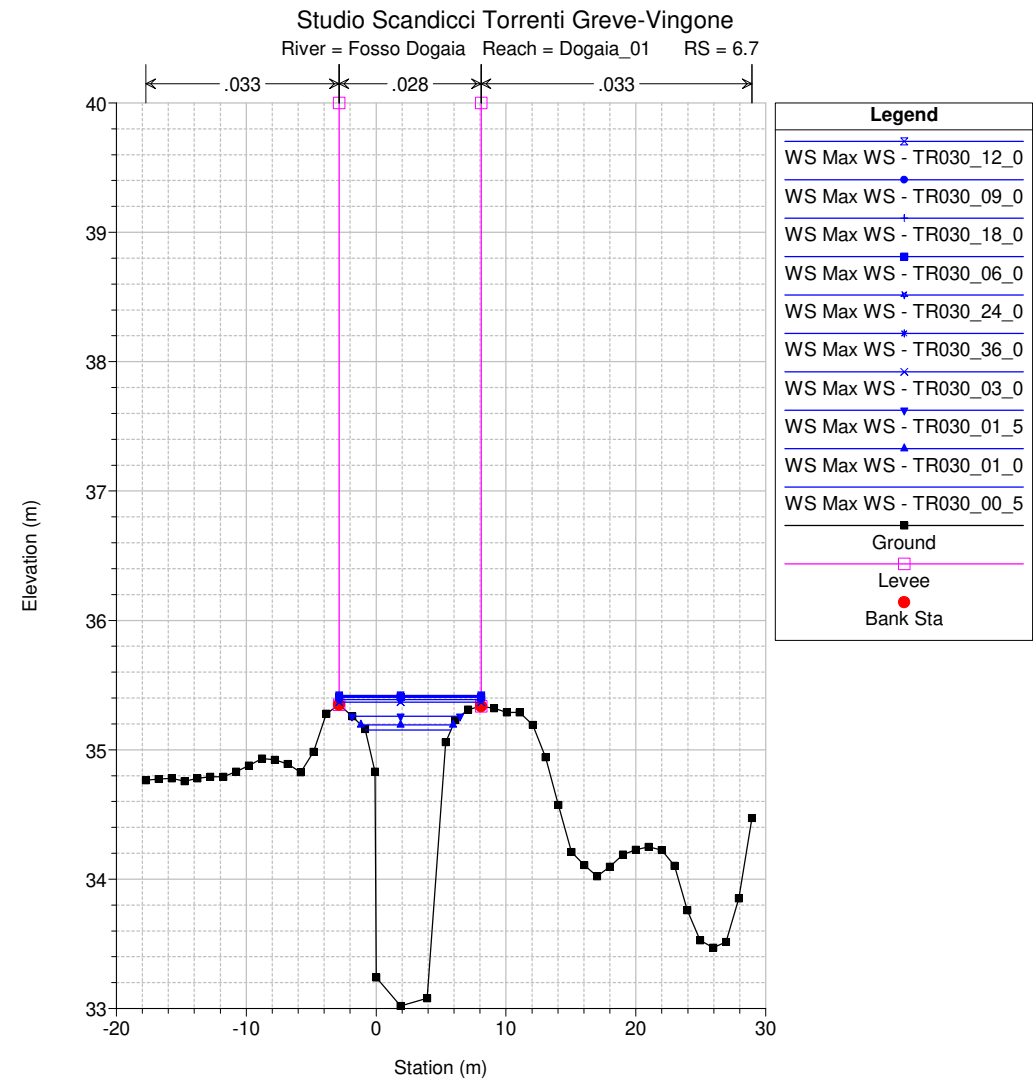
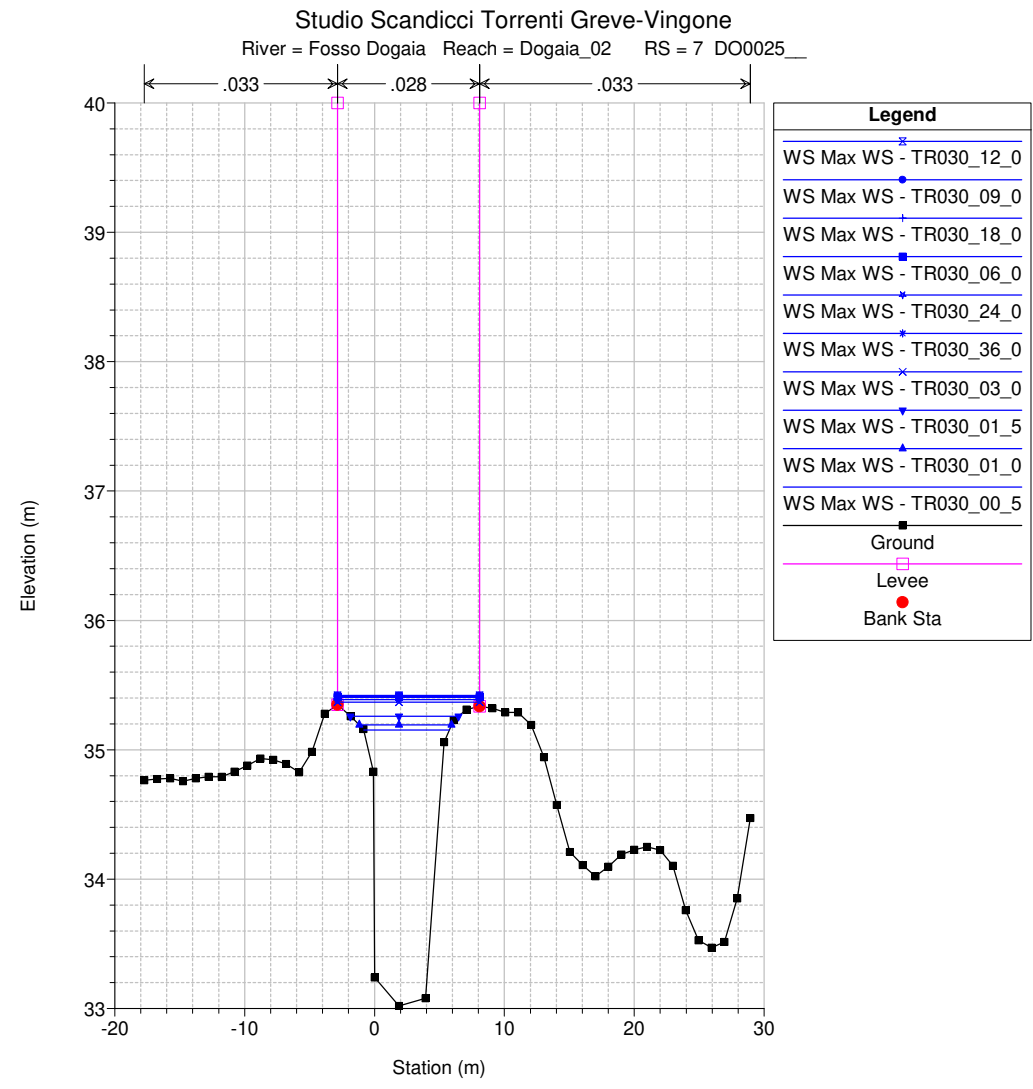
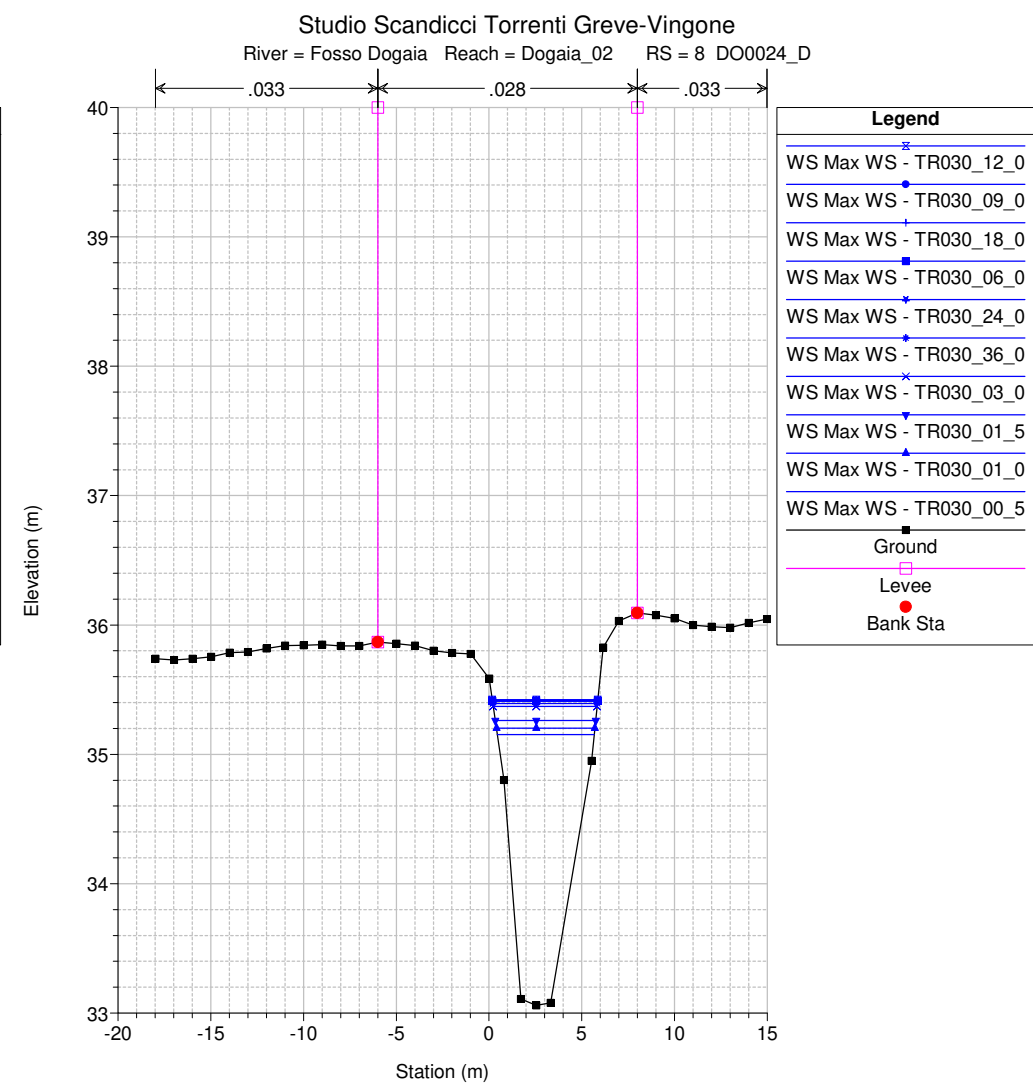
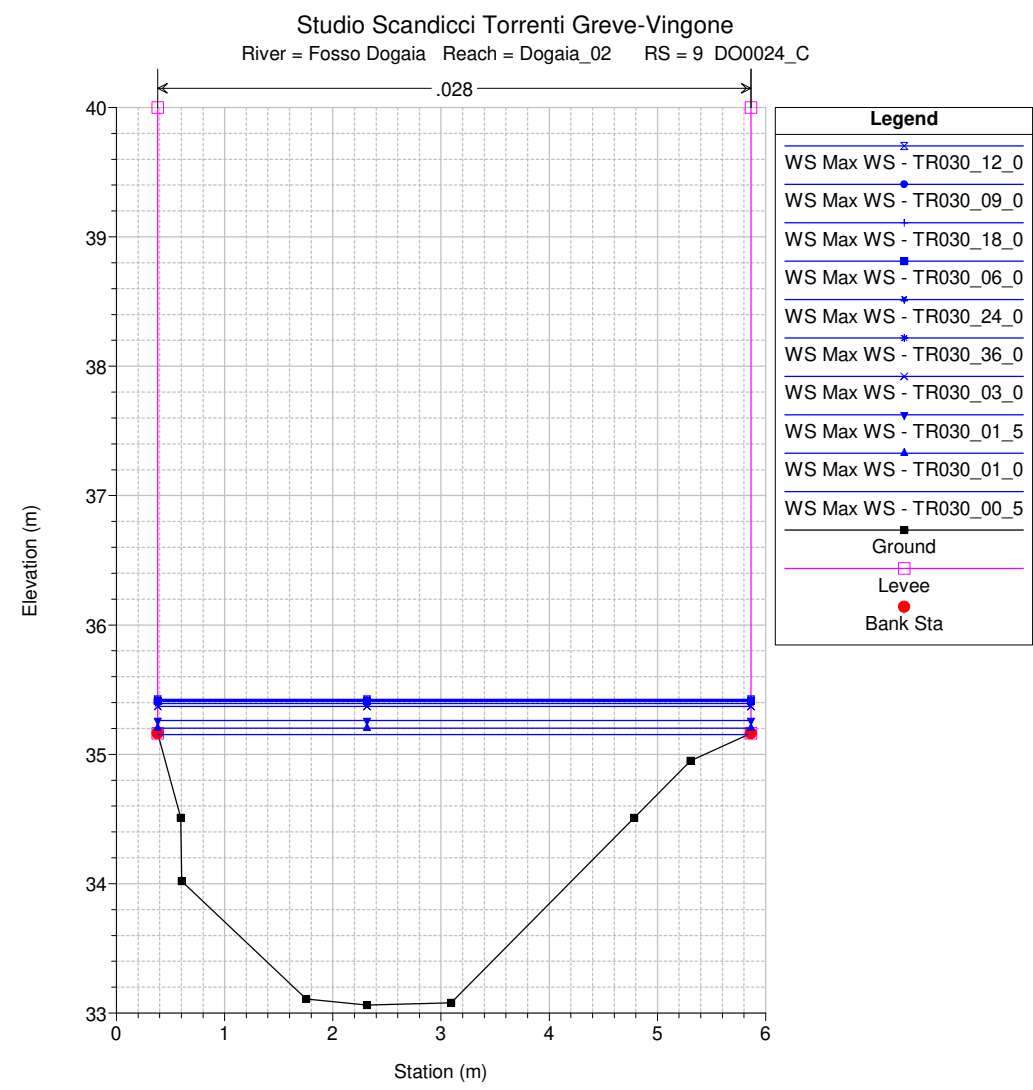
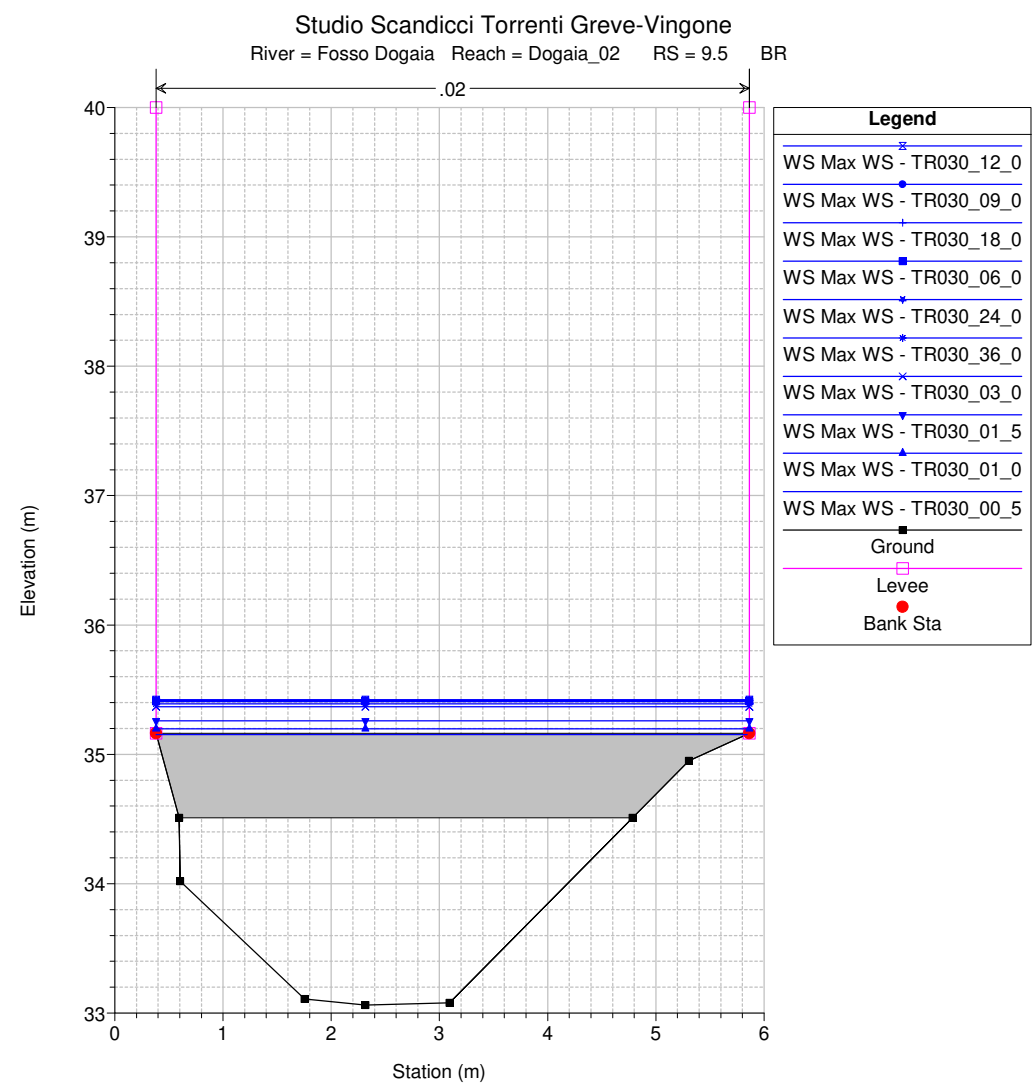

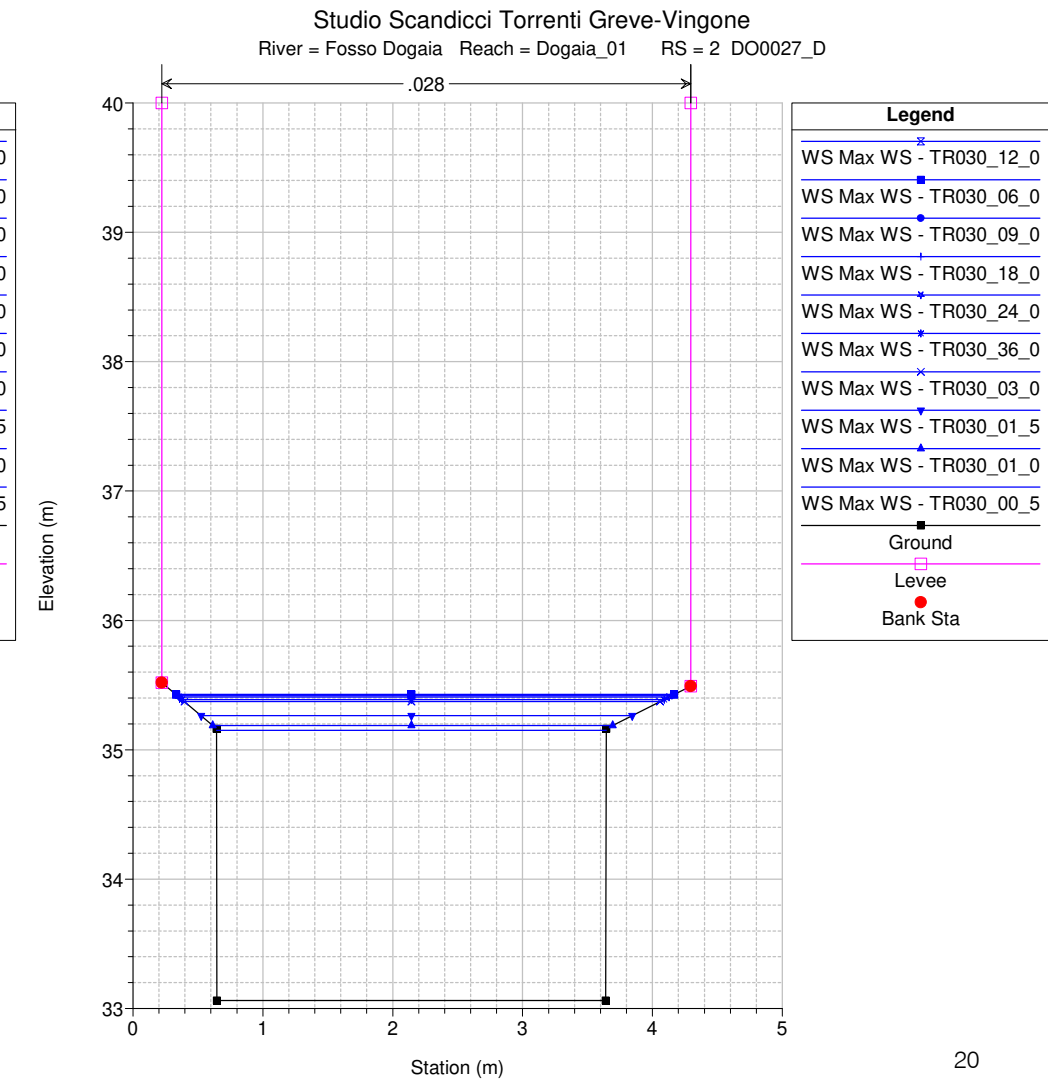
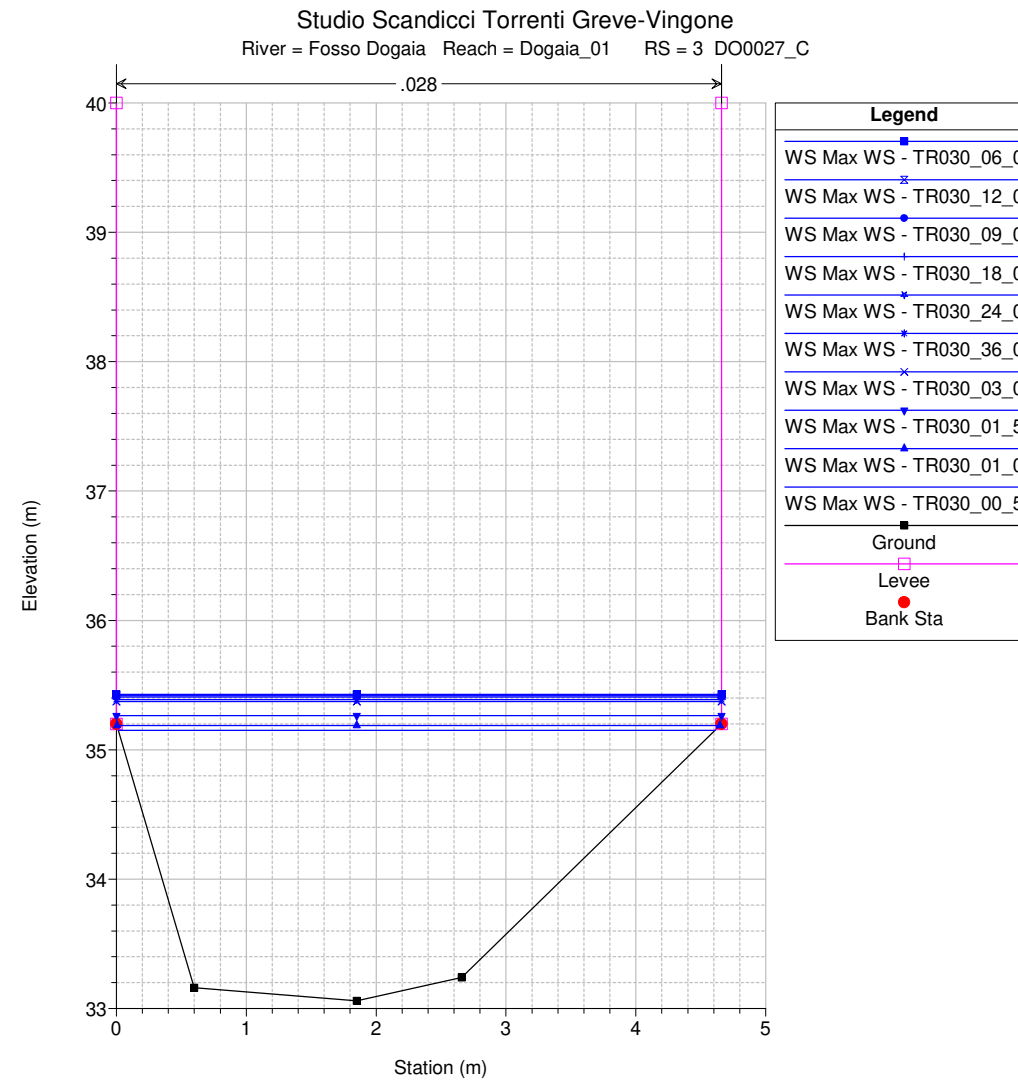
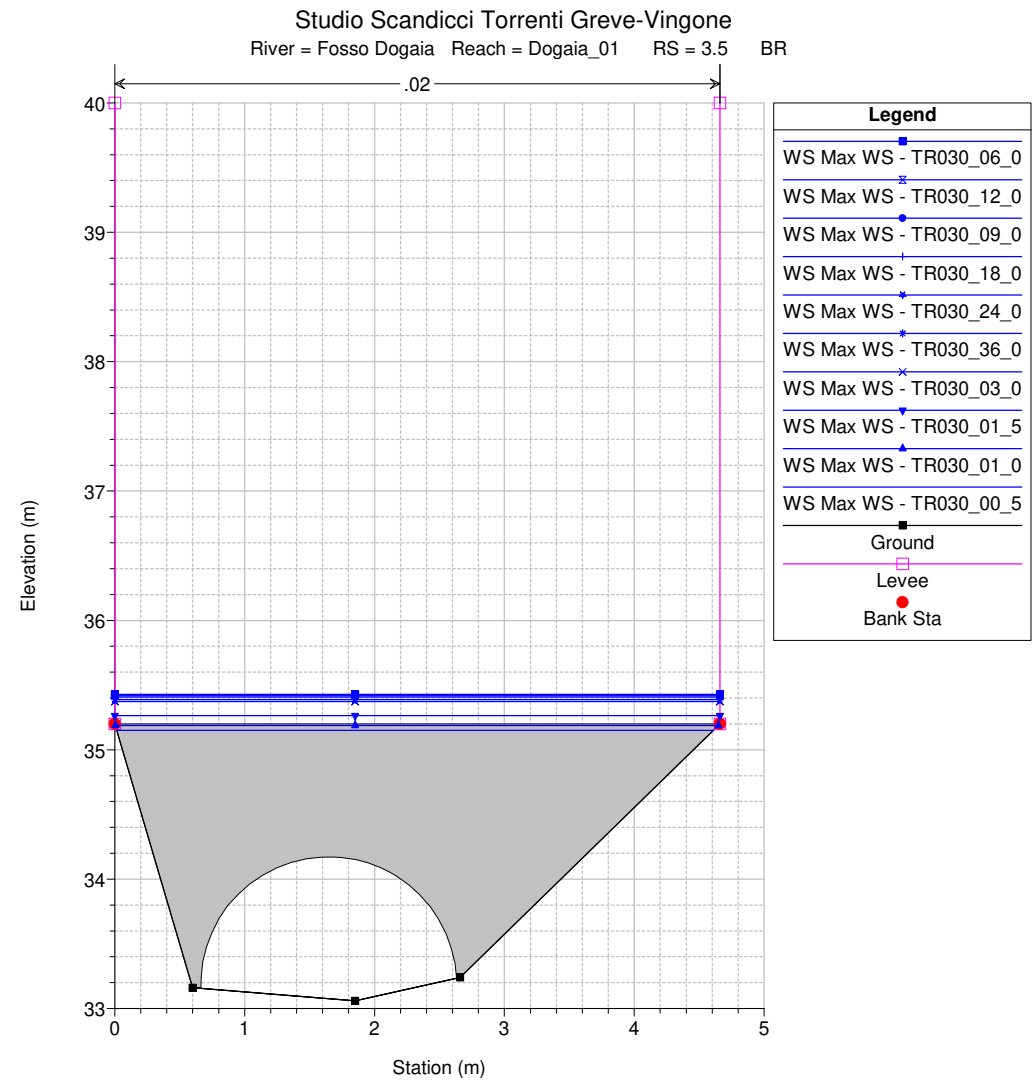
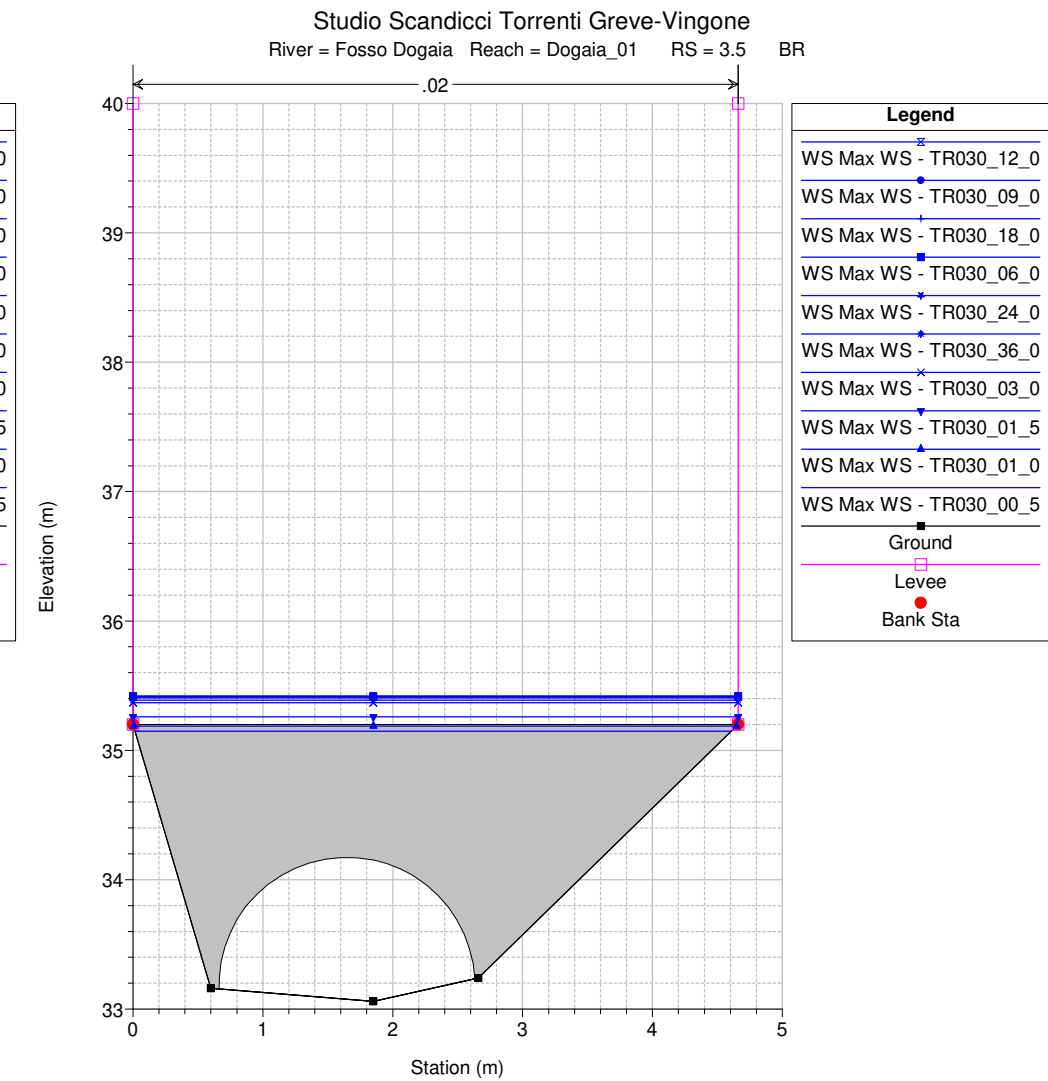
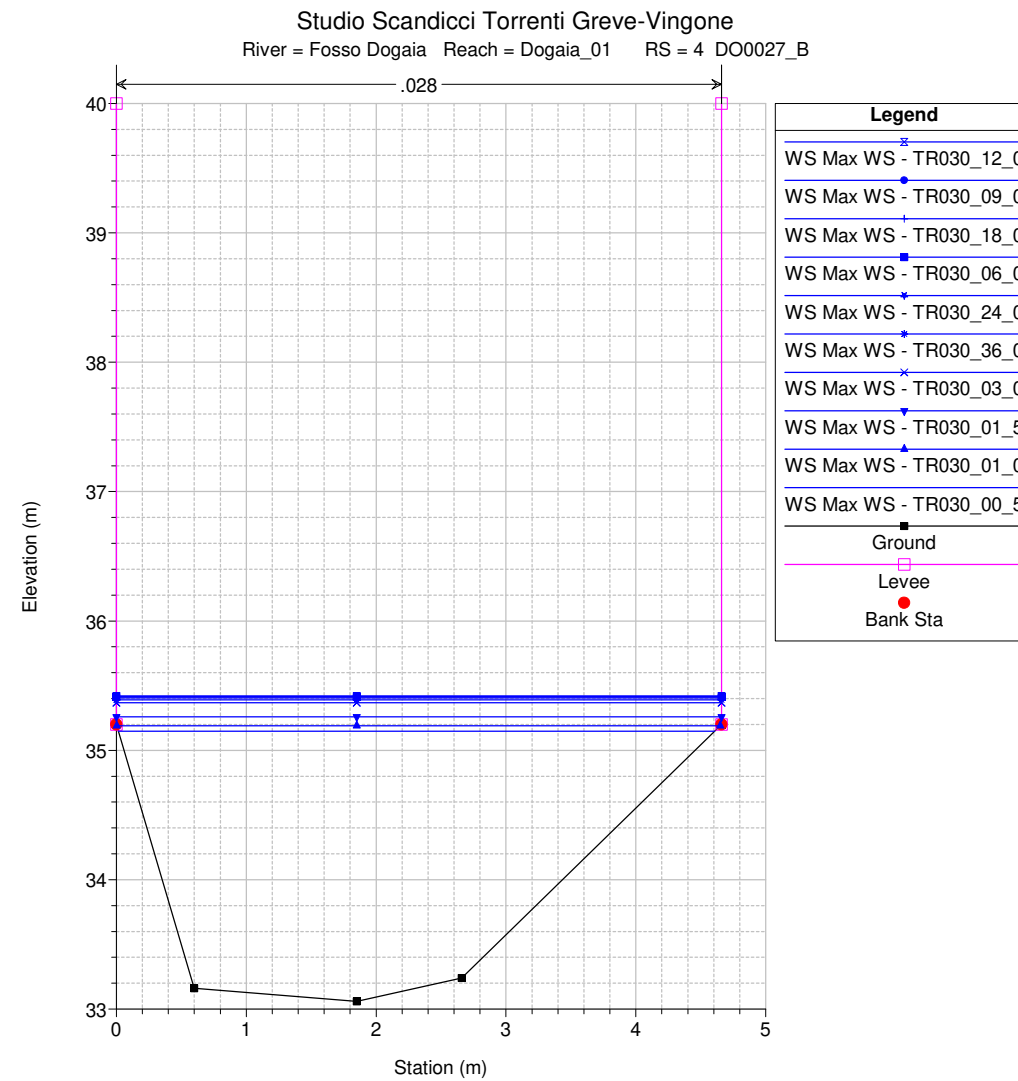
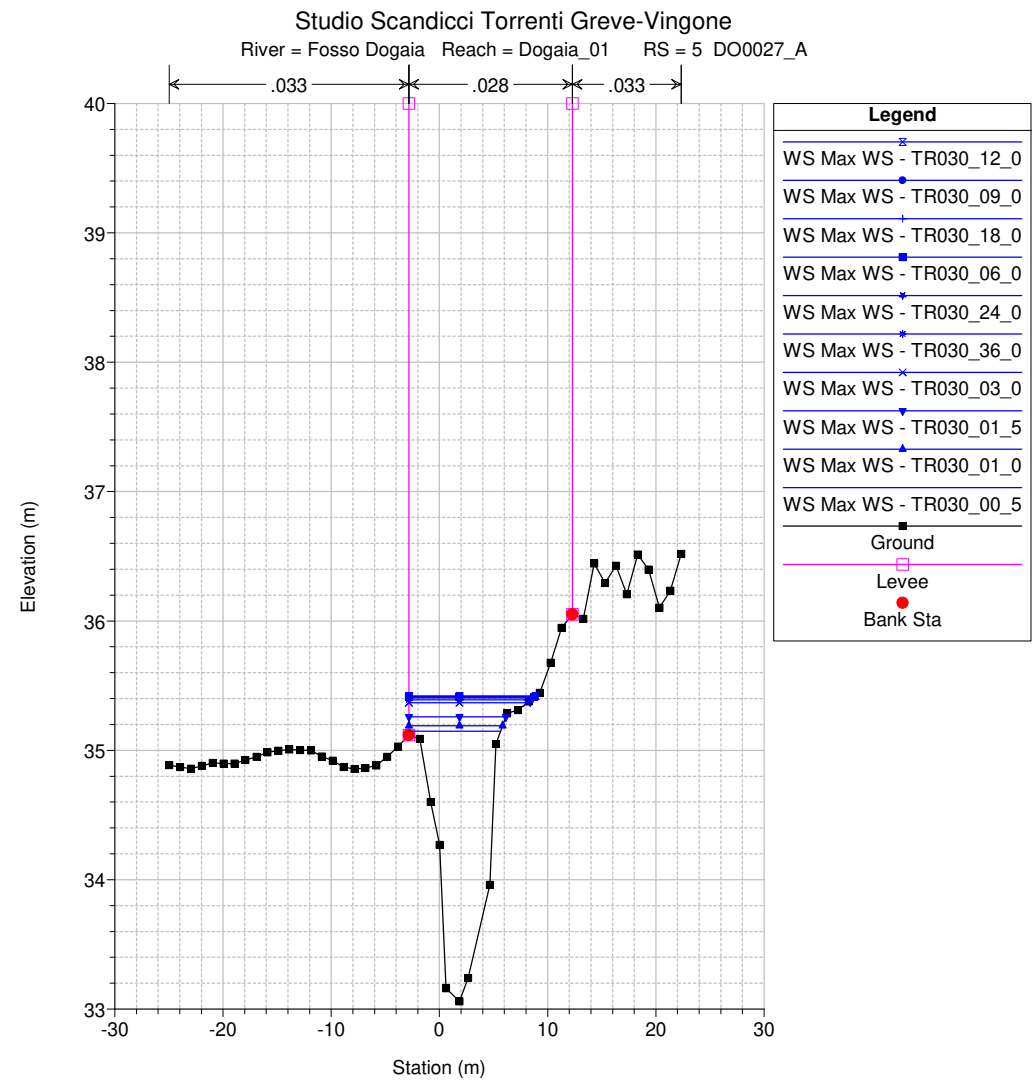

Studio Scandicci Torrenti Greve-Vingone
River = Fosso Dogaia Reach = Dogaia_01 RS = 1.75 Culv

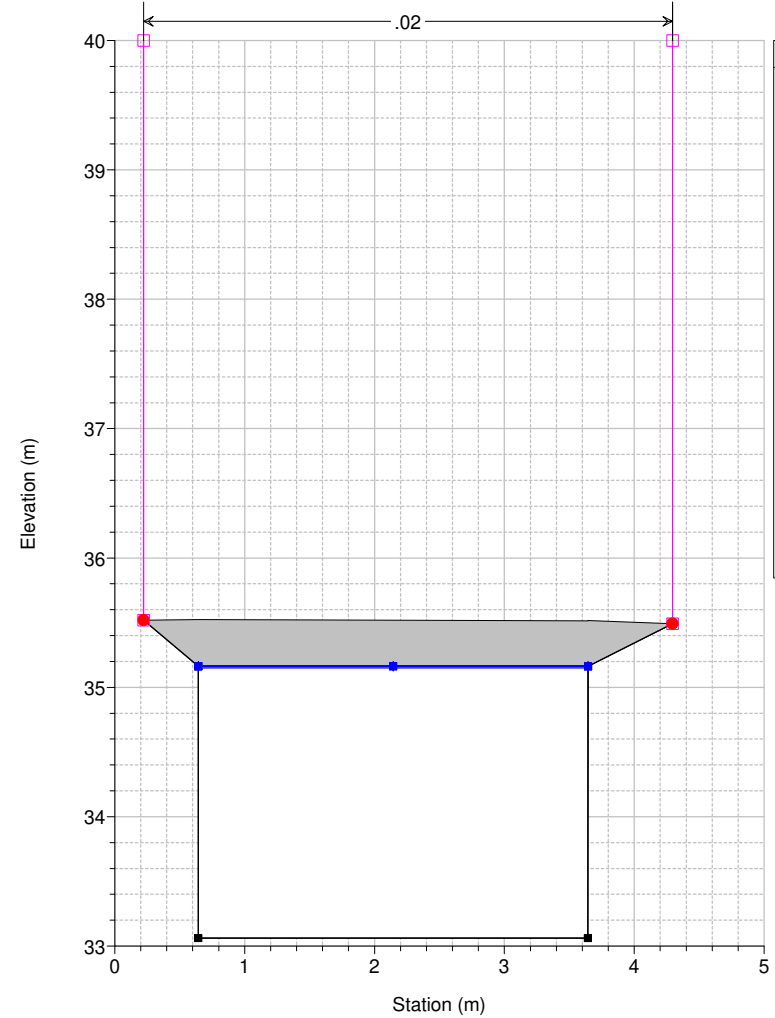

Legend	
WS Max WS - TR030_01_0	▲
WS Max WS - TR030_01_5	▼
WS Max WS - TR030_03_0	×
WS Max WS - TR030_06_0	■
WS Max WS - TR030_09_0	●
WS Max WS - TR030_12_0	+
WS Max WS - TR030_18_0	↑
WS Max WS - TR030_24_0	↓
WS Max WS - TR030_36_0	+
WS Max WS - TR030_00_5	+
Ground	■
Levee	□
Bank Sta	●

Studio Scandicci Torrenti Greve-Vingone
River = Fosso Dogaia Reach = Dogaia_01 RS = 1.75 Culv

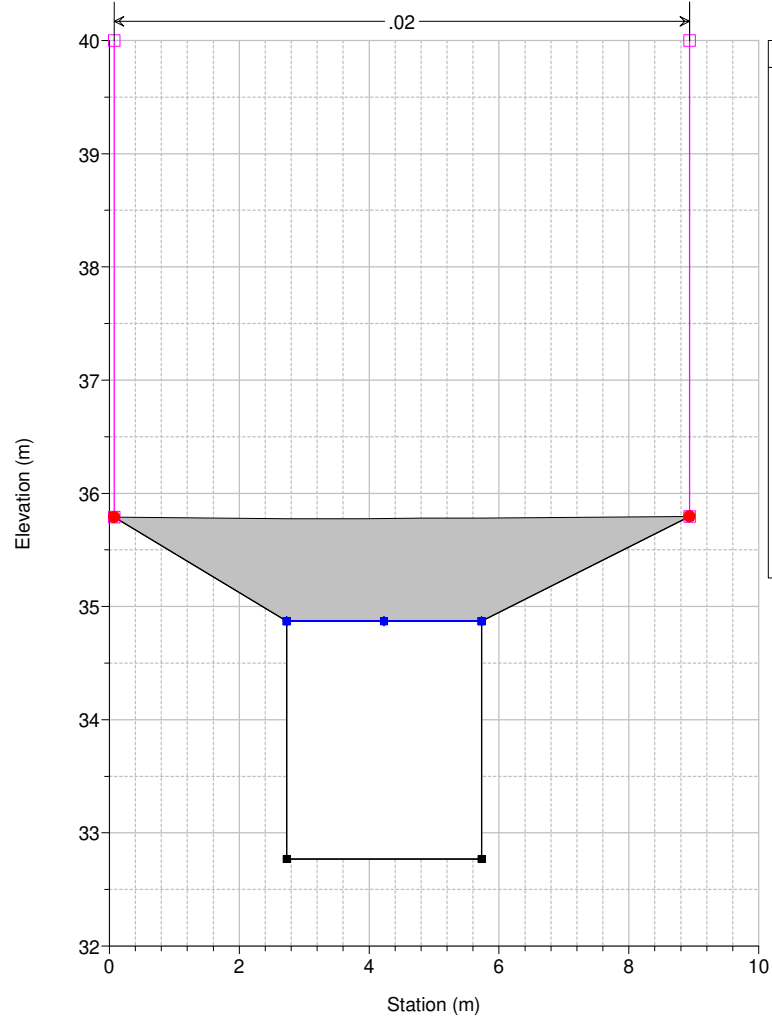

Legend	
WS Max WS - TR030_00_5	+
WS Max WS - TR030_01_0	▲
WS Max WS - TR030_01_5	▼
WS Max WS - TR030_03_0	×
WS Max WS - TR030_06_0	■
WS Max WS - TR030_09_0	●
WS Max WS - TR030_12_0	+
WS Max WS - TR030_18_0	↑
WS Max WS - TR030_24_0	↓
WS Max WS - TR030_36_0	+
Ground	■
Levee	□
Bank Sta	●

Studio Scandicci Torrenti Greve-Vingone
River = Fosso Dogaia Reach = Dogaia_01 RS = 1.4 DO0032_C

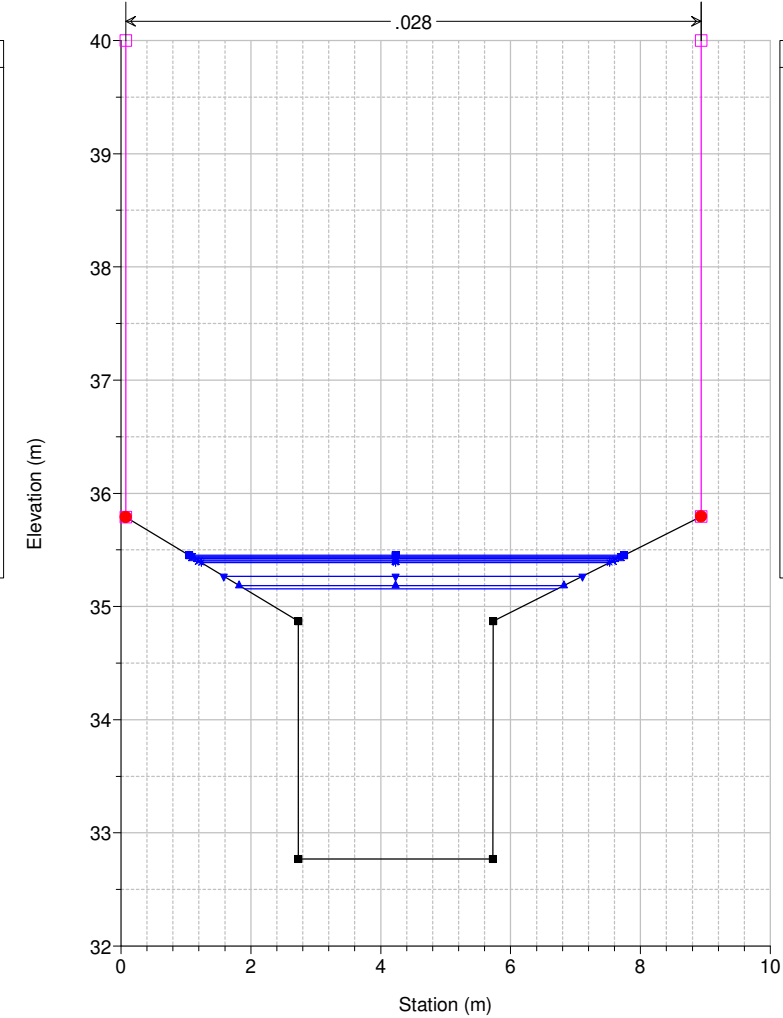

Legend	
WS Max WS - TR030_06_0	■
WS Max WS - TR030_09_0	●
WS Max WS - TR030_12_0	×
WS Max WS - TR030_18_0	↑
WS Max WS - TR030_24_0	↓
WS Max WS - TR030_03_0	+
WS Max WS - TR030_36_0	+
WS Max WS - TR030_01_5	▼
WS Max WS - TR030_01_0	▲
WS Max WS - TR030_00_5	+
Ground	■
Levee	□
Bank Sta	●

Studio Scandicci Torrenti Greve-Vingone
River = Fosso Dogaia Reach = Dogaia_01 RS = 1 DO0032_D

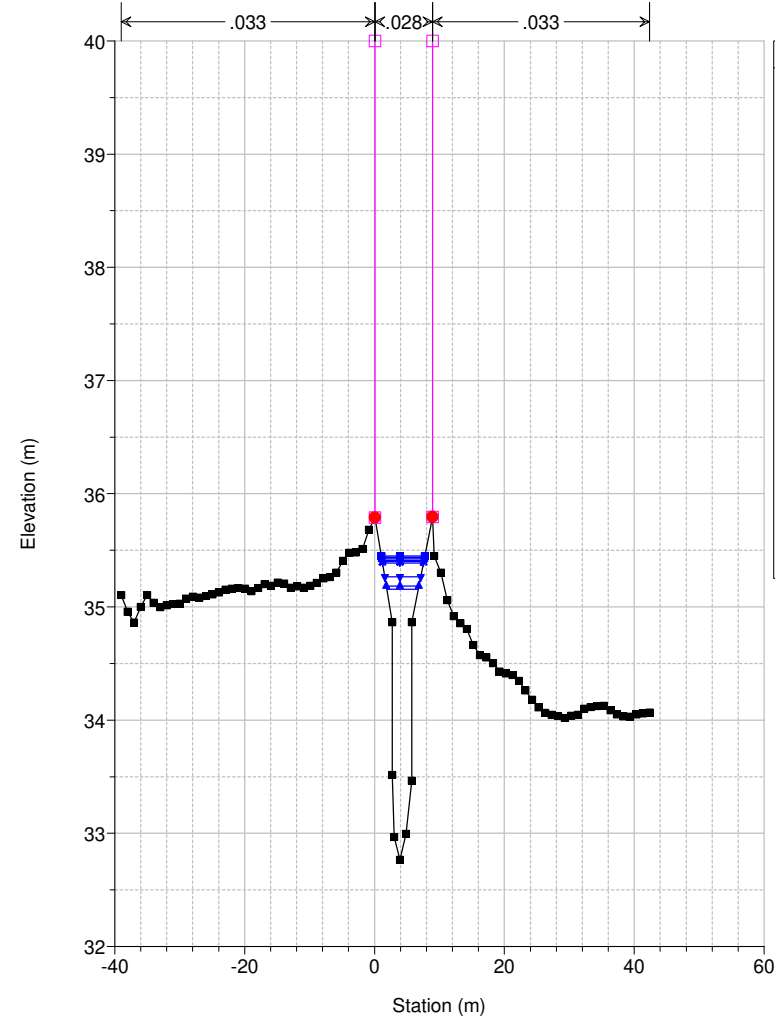

Legend	
WS Max WS - TR030_06_0	■
WS Max WS - TR030_09_0	●
WS Max WS - TR030_12_0	×
WS Max WS - TR030_18_0	↑
WS Max WS - TR030_24_0	↓
WS Max WS - TR030_03_0	+
WS Max WS - TR030_36_0	+
WS Max WS - TR030_01_5	▼
WS Max WS - TR030_01_0	▲
WS Max WS - TR030_00_5	+
Ground	■
Levee	□
Bank Sta	●

Studio Scandicci Torrenti Greve-Vingone

River = Fosso Dogaione Reach = Dogaione RS = 65 DG1002_D

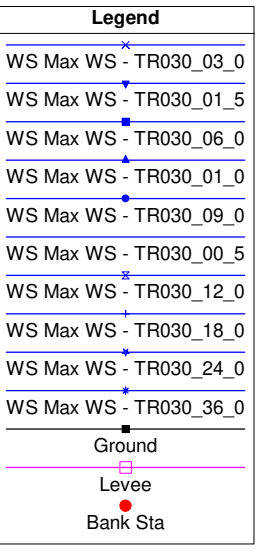
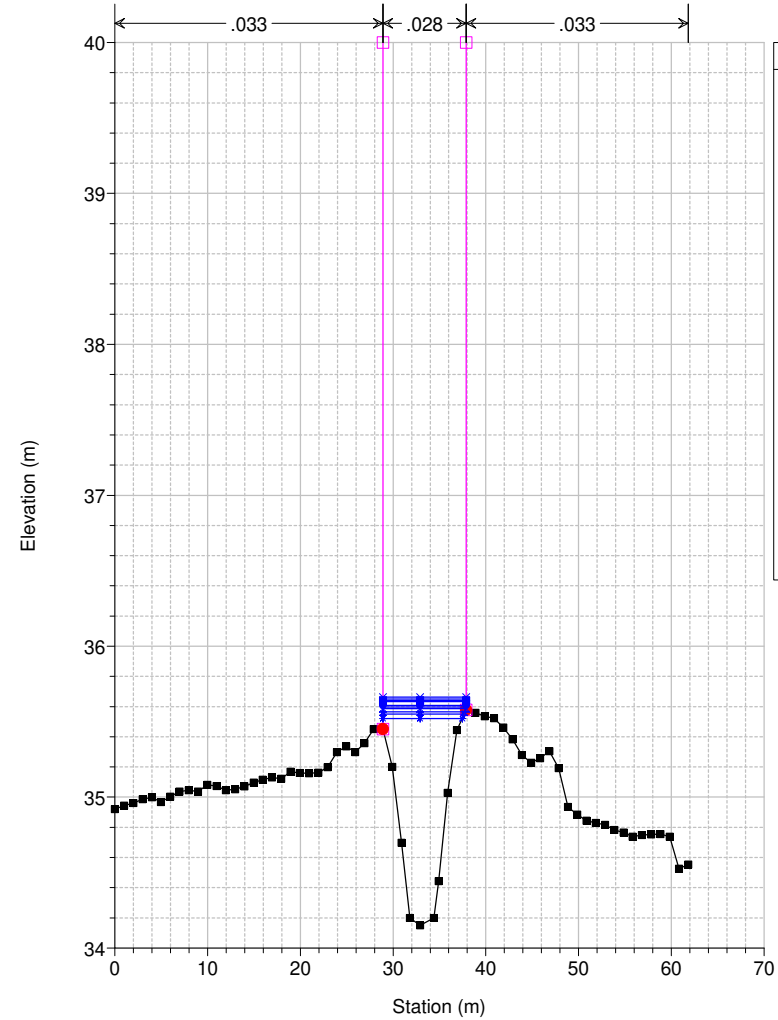

Studio Scandicci Torrenti Greve-Vingone

River = Fosso Dogaione Reach = Dogaione RS = 64 DG0003_

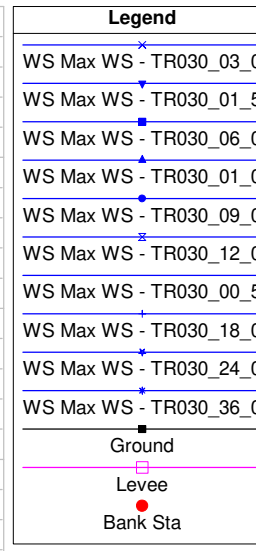
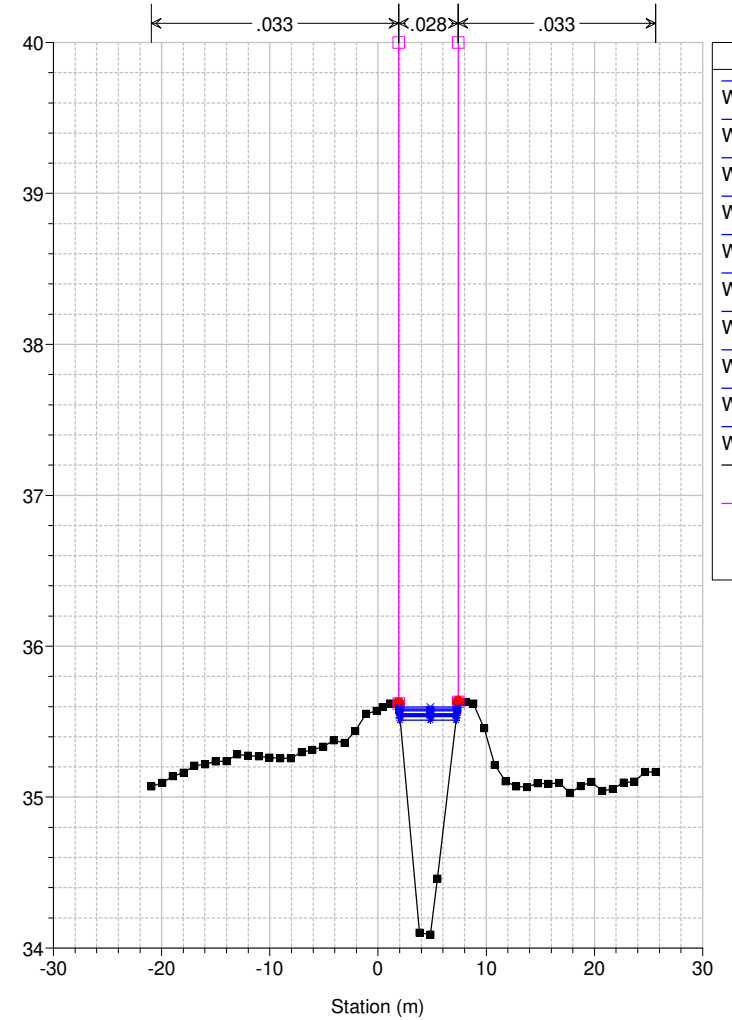

Studio Scandicci Torrenti Greve-Vingone

River = Fosso Dogaione Reach = Dogaione RS = 63 DG0004_

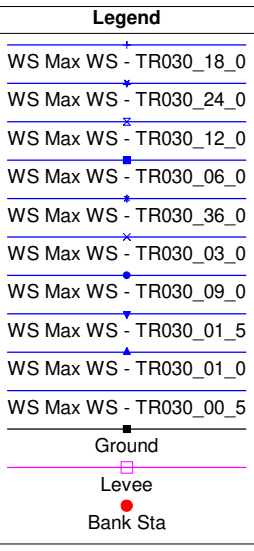
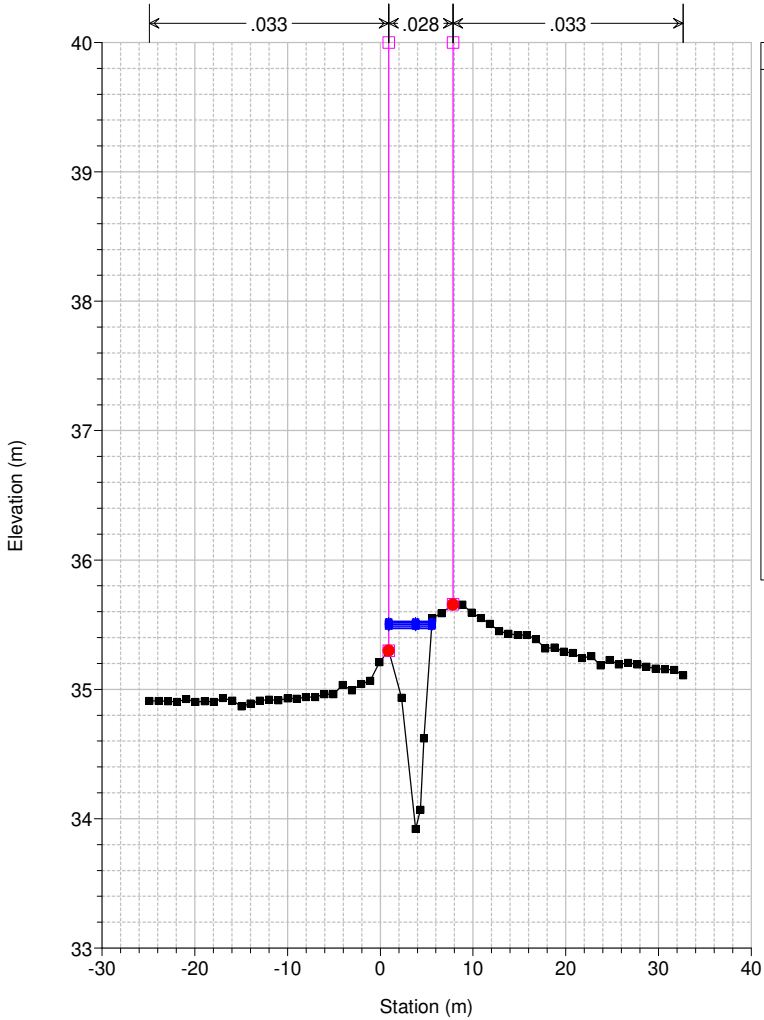

Studio Scandicci Torrenti Greve-Vingone

River = Fosso Dogaione Reach = Dogaione RS = 62 DG0005_

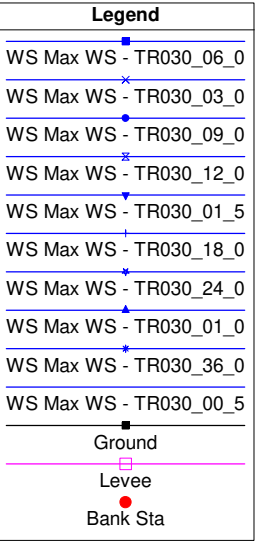
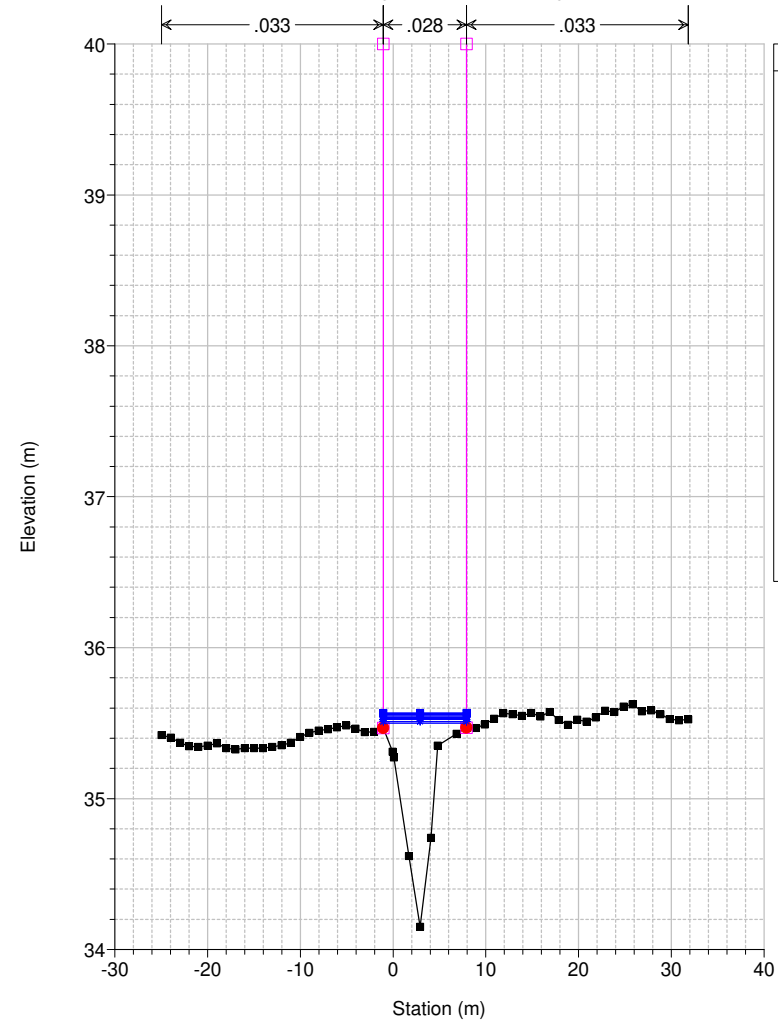

Studio Scandicci Torrenti Greve-Vingone

River = Fosso Dogaione Reach = Dogaione RS = 61 DG0006_

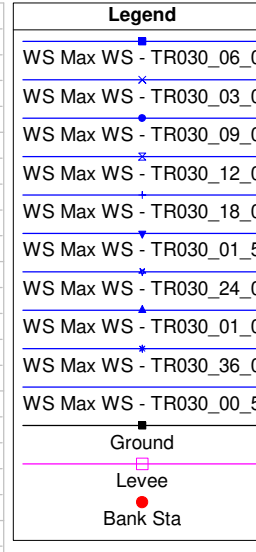
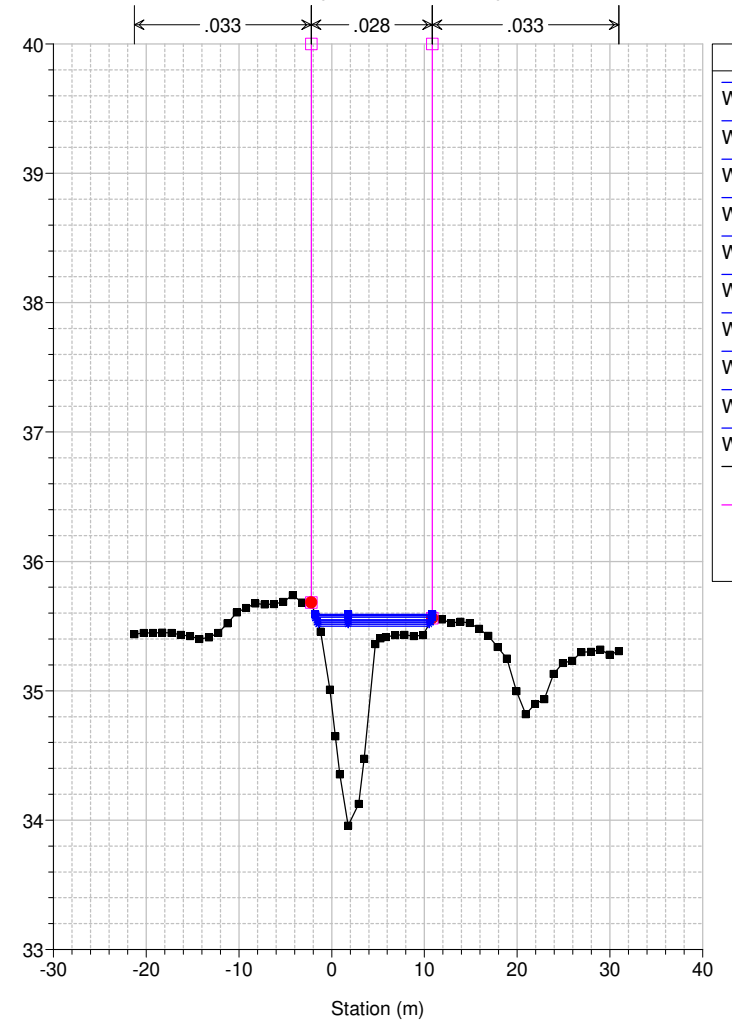

Studio Scandicci Torrenti Greve-Vingone

River = Fosso Dogaione Reach = Dogaione RS = 60 DG1006_A

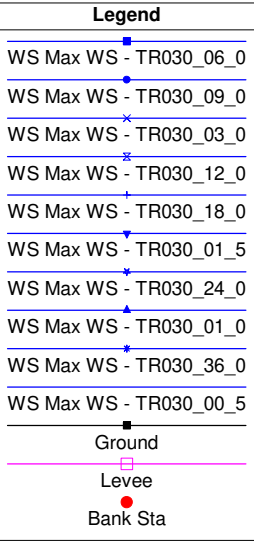
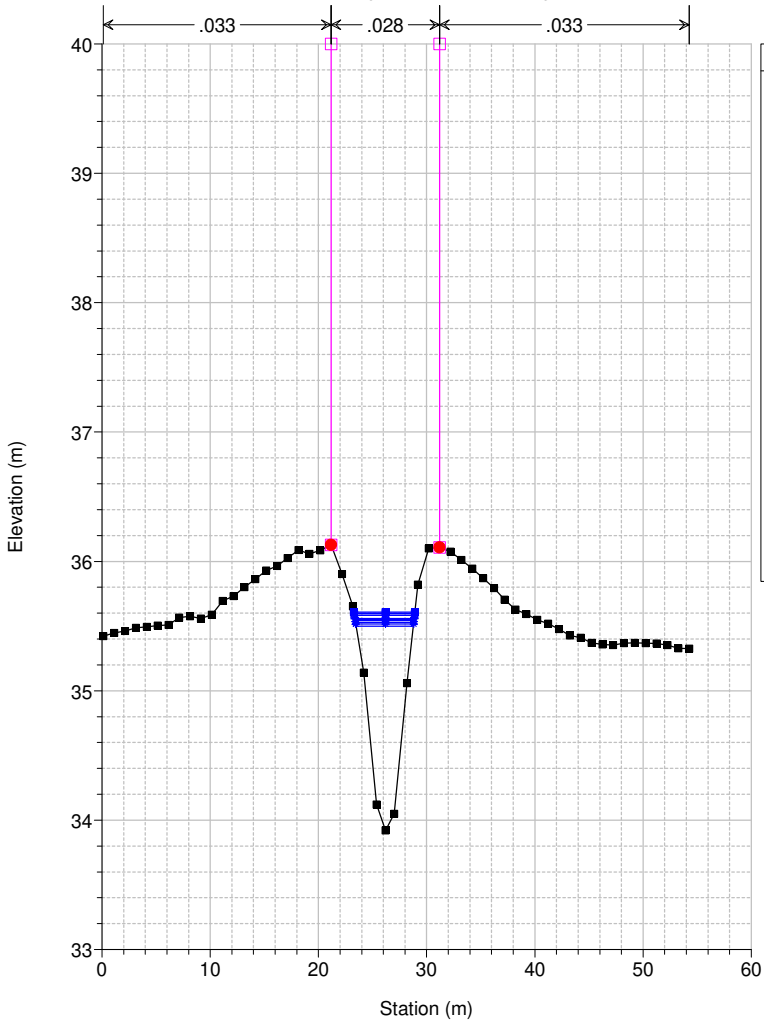

Studio Scandicci Torrenti Greve-Vingone
River = Fosso Dogaione Reach = Dogaione RS = 59 DG1006_B

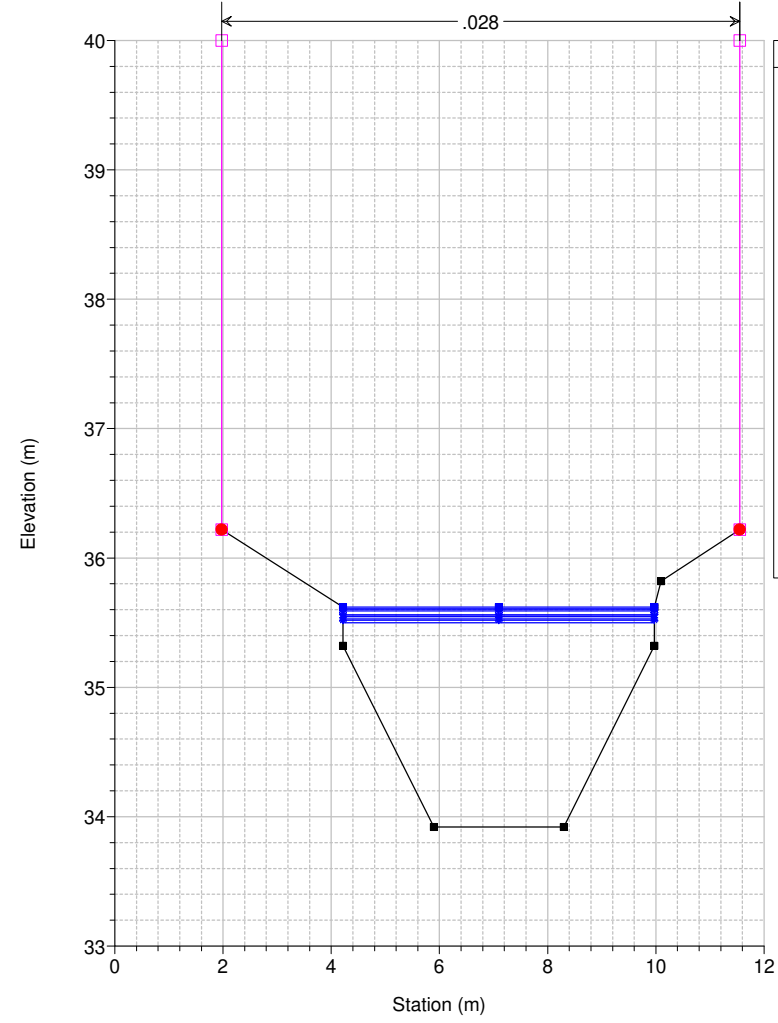

Studio Scandicci Torrenti Greve-Vingone
River = Fosso Dogaione Reach = Dogaione RS = 58.5 BR

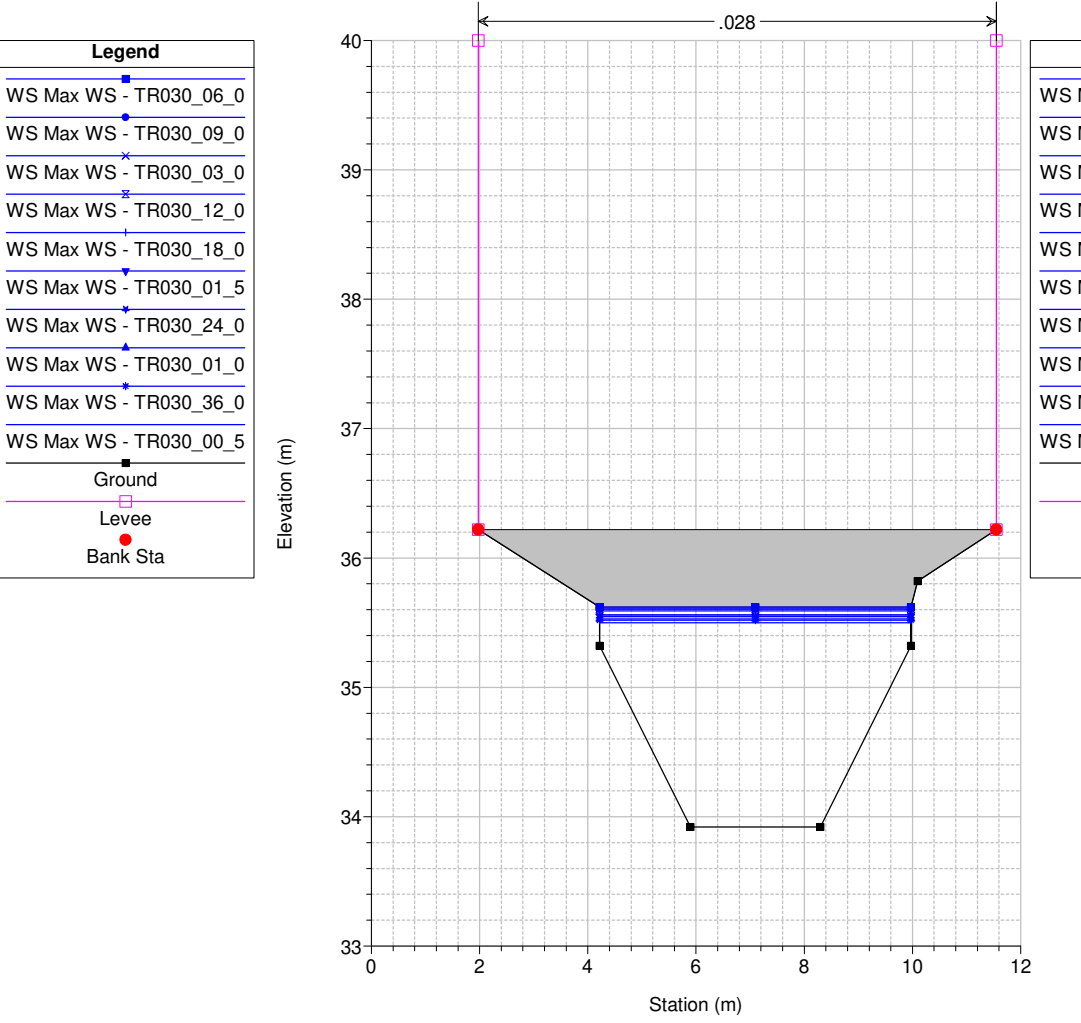

Studio Scandicci Torrenti Greve-Vingone
River = Fosso Dogaione Reach = Dogaione RS = 58.5 BR

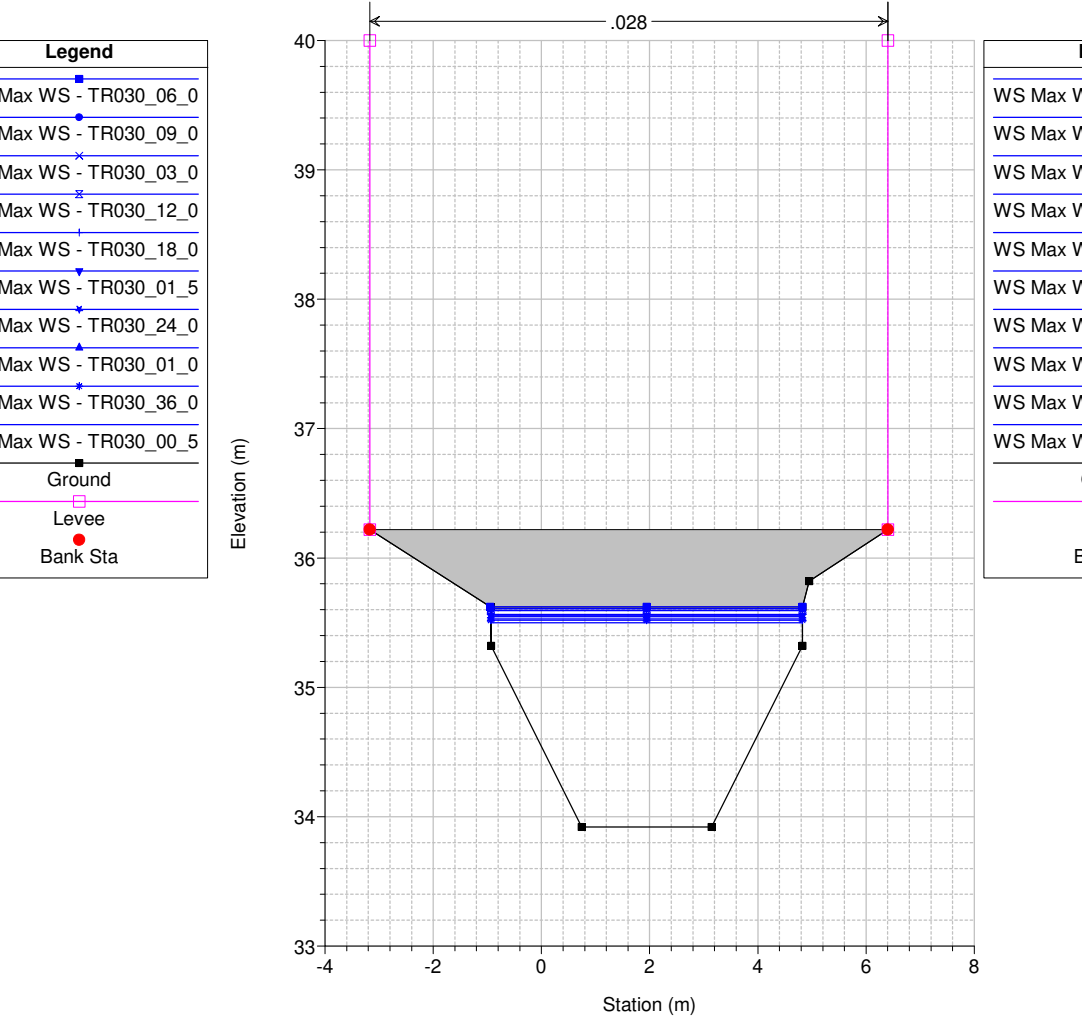

Studio Scandicci Torrenti Greve-Vingone
River = Fosso Dogaione Reach = Dogaione RS = 58 DG1006_C

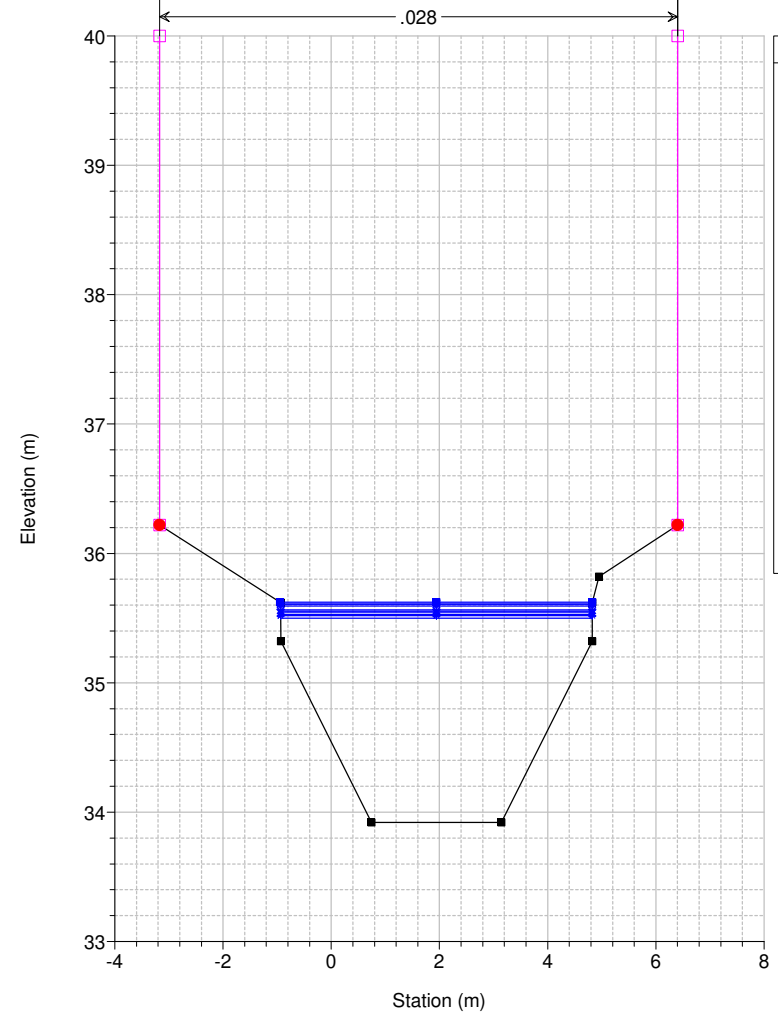

Studio Scandicci Torrenti Greve-Vingone
River = Fosso Dogaione Reach = Dogaione RS = 57 DG1006_D

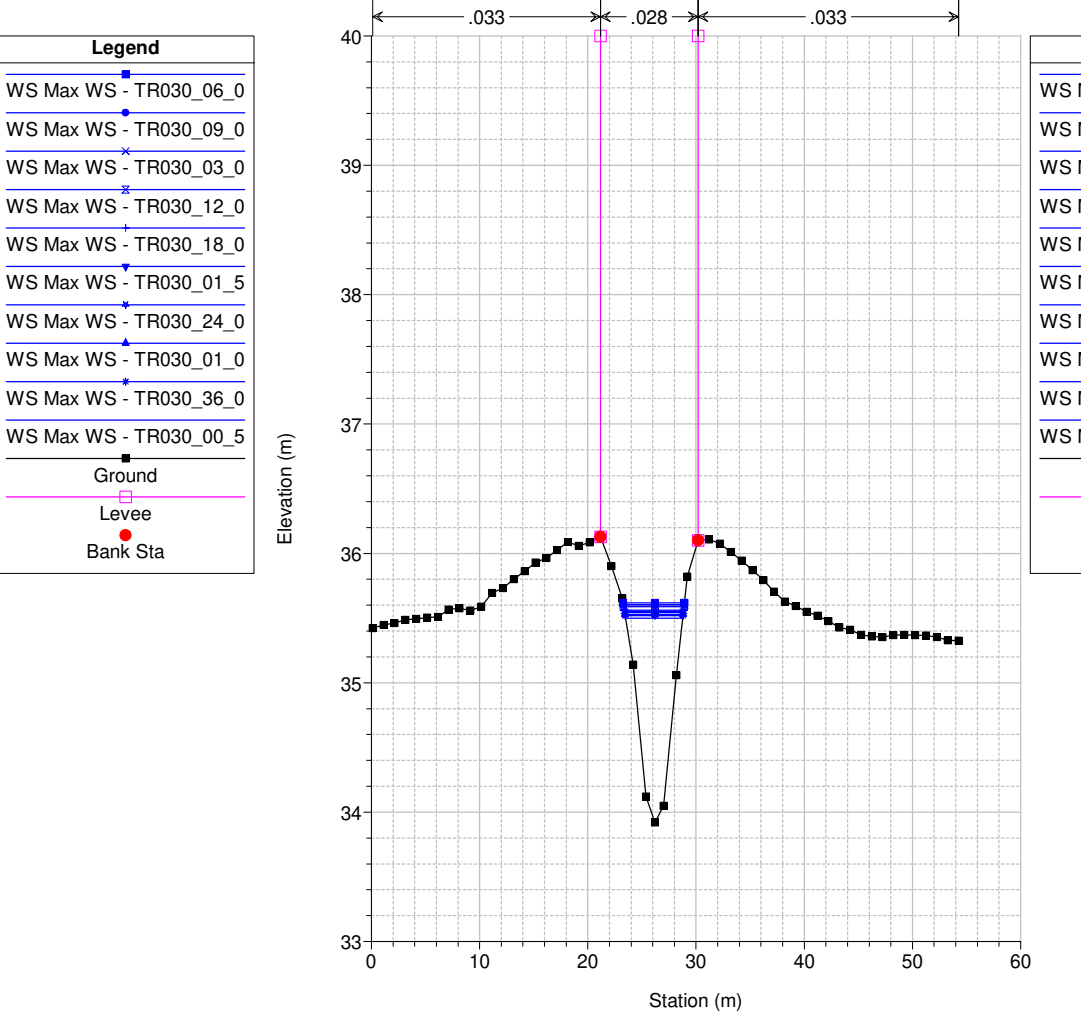

Studio Scandicci Torrenti Greve-Vingone
River = Fosso Dogaione Reach = Dogaione RS = 56 DG0007_A

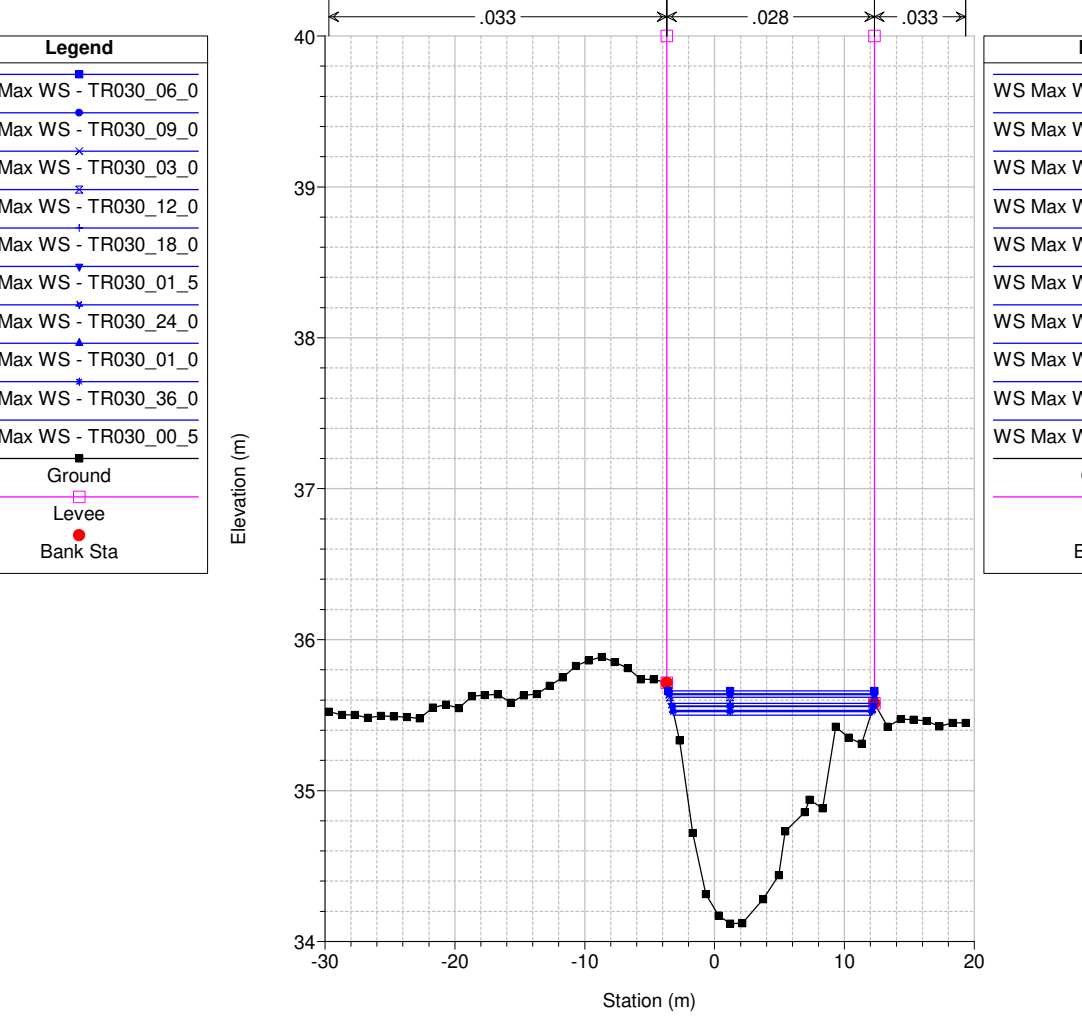

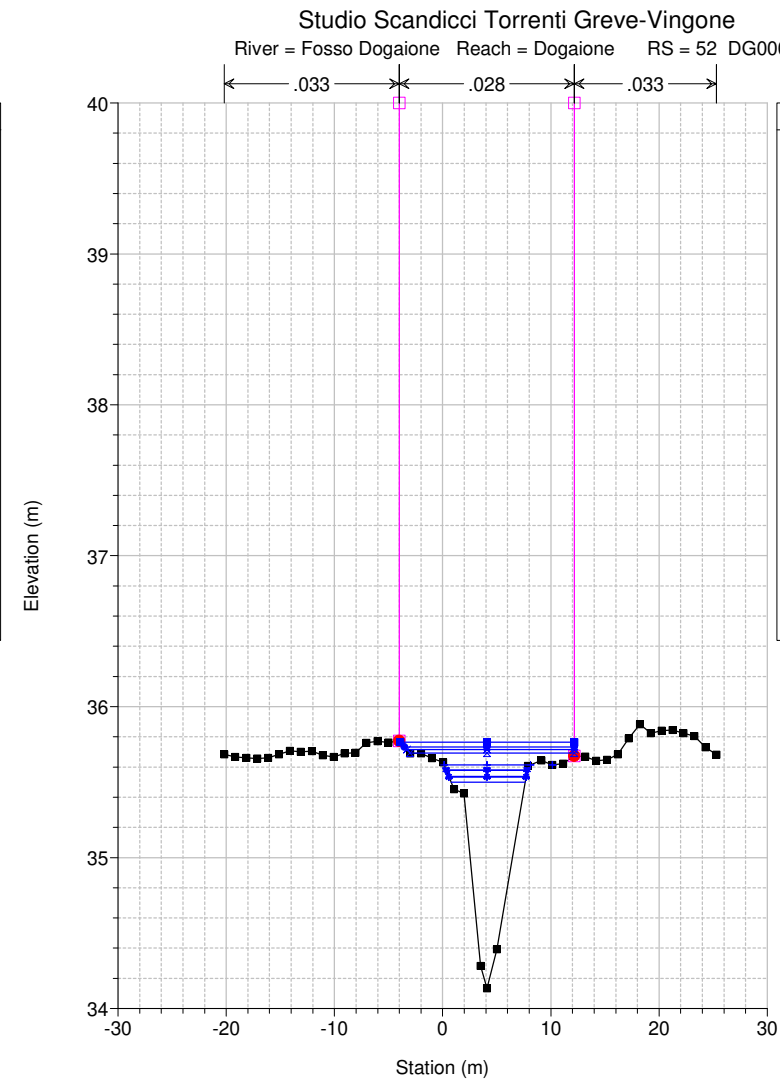
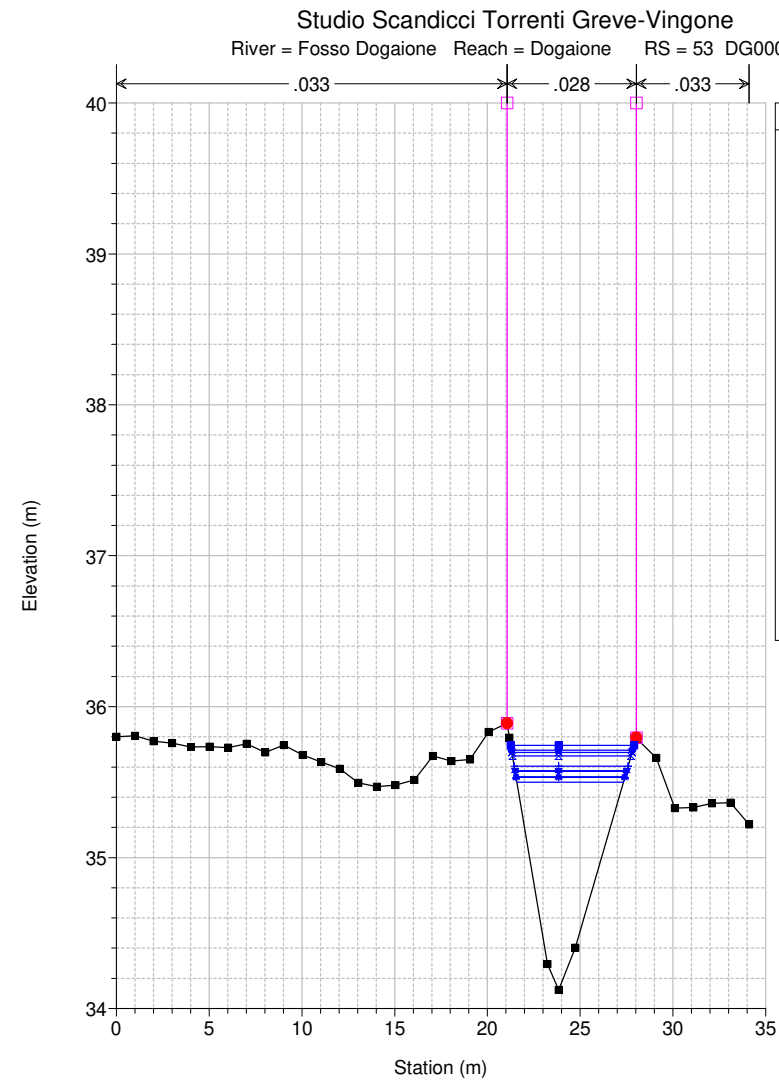
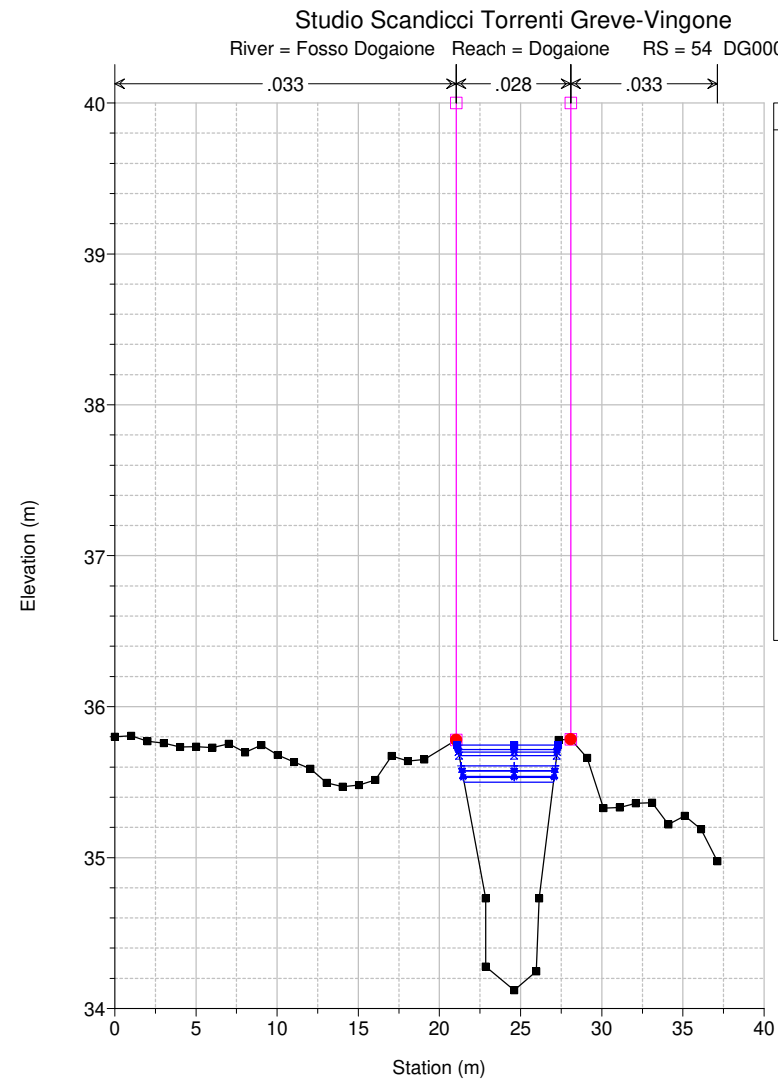
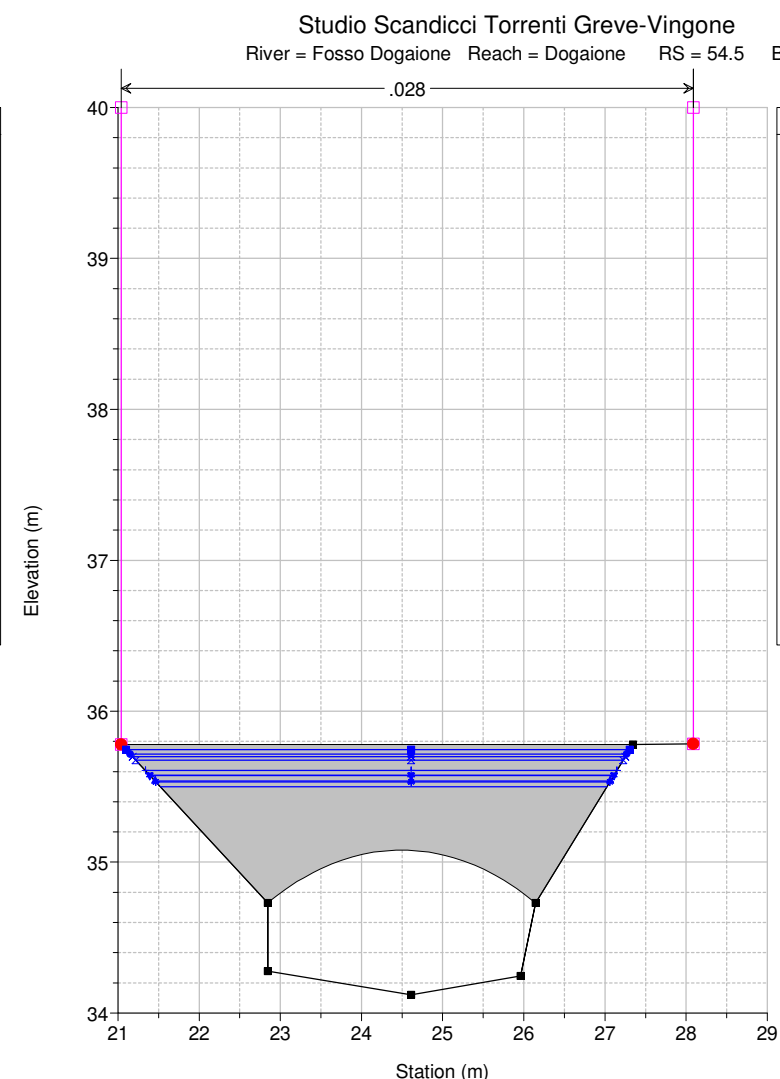
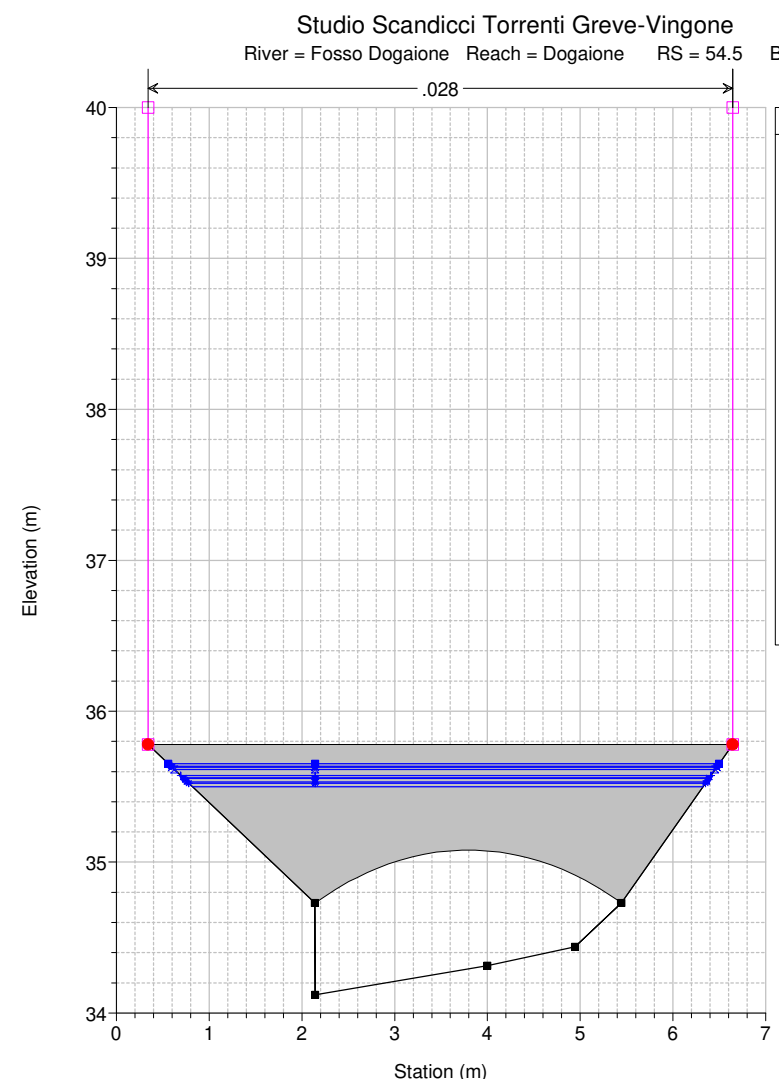
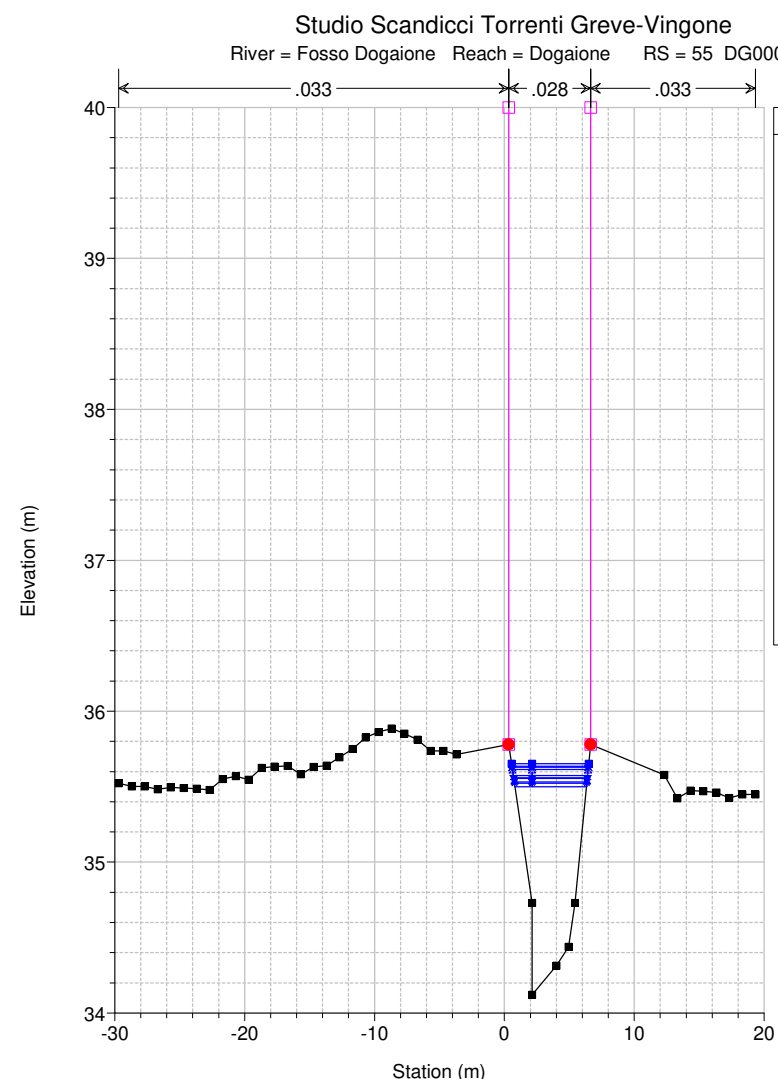

Studio Scandicci Torrenti Greve-Vingone
River = Fosso Dogaione Reach = Dogaione RS = 51 DG0009_A

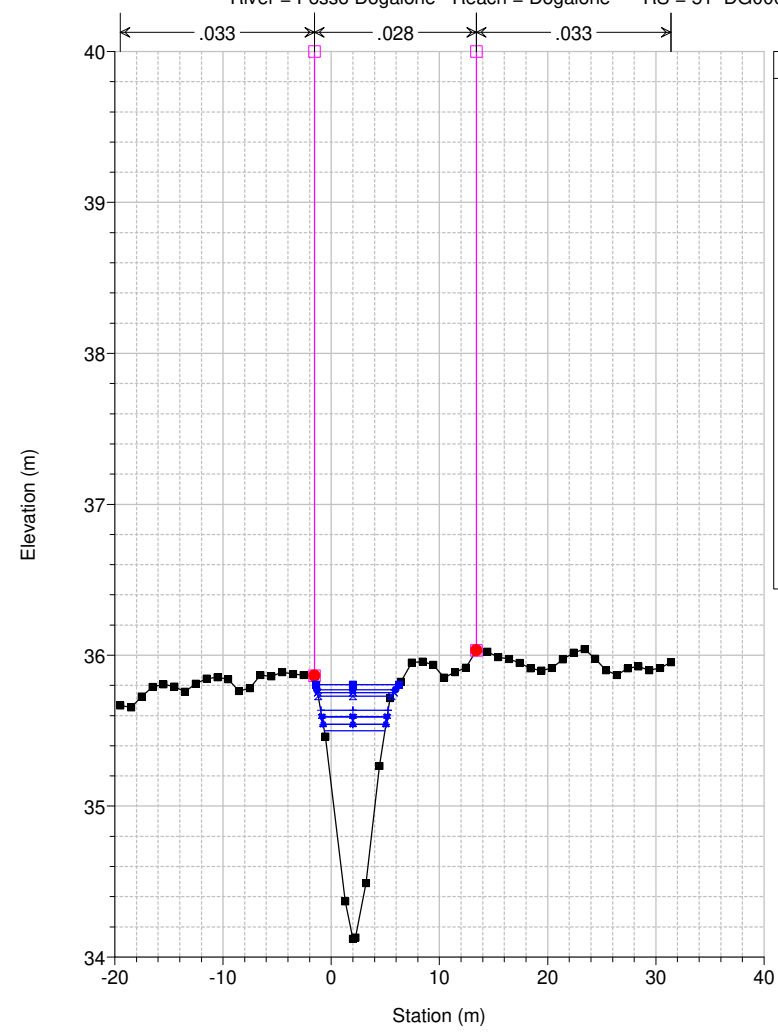

Legend

- WS Max WS - TR030_06_0
- WS Max WS - TR030_09_0
- WS Max WS - TR030_03_0
- WS Max WS - TR030_12_0
- WS Max WS - TR030_18_0
- WS Max WS - TR030_01_5
- WS Max WS - TR030_24_0
- WS Max WS - TR030_01_0
- WS Max WS - TR030_36_0
- WS Max WS - TR030_00_5
- Ground
- Levee
- Bank Sta

Studio Scandicci Torrenti Greve-Vingone
River = Fosso Dogaione Reach = Dogaione RS = 50 DG0009_B

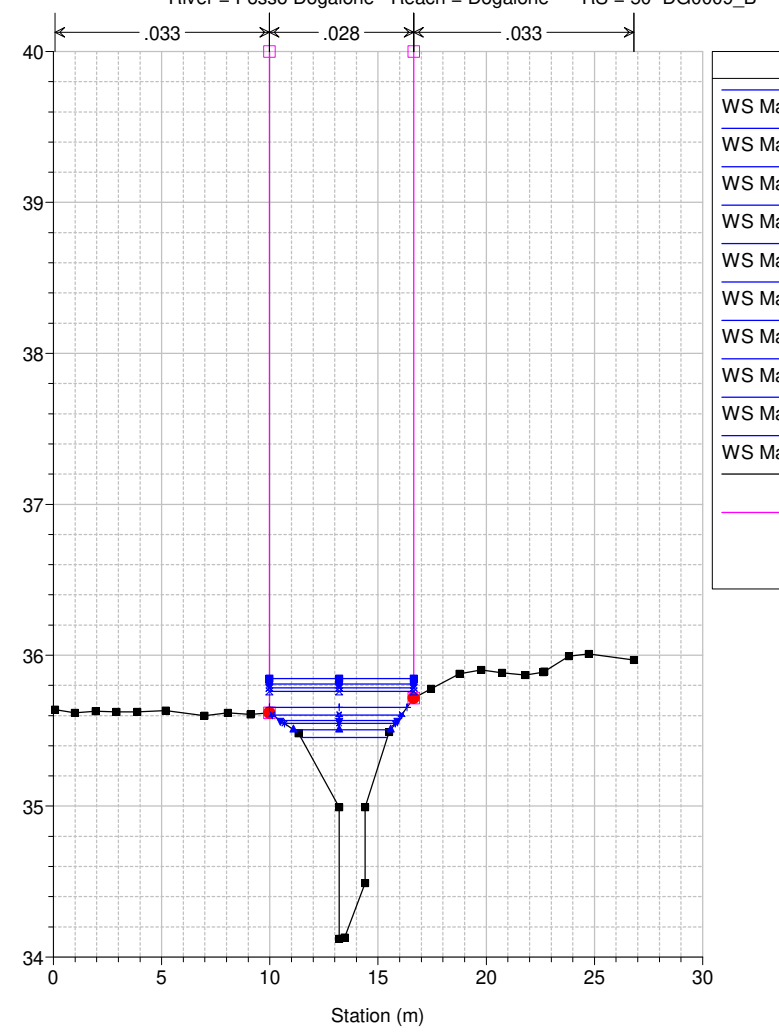

Legend

- WS Max WS - TR030_06_0
- WS Max WS - TR030_09_0
- WS Max WS - TR030_03_0
- WS Max WS - TR030_12_0
- WS Max WS - TR030_18_0
- WS Max WS - TR030_24_0
- WS Max WS - TR030_01_5
- WS Max WS - TR030_36_0
- WS Max WS - TR030_01_0
- WS Max WS - TR030_00_5
- Ground
- Levee
- Bank Sta

Studio Scandicci Torrenti Greve-Vingone
River = Fosso Dogaione Reach = Dogaione RS = 49.5 BR

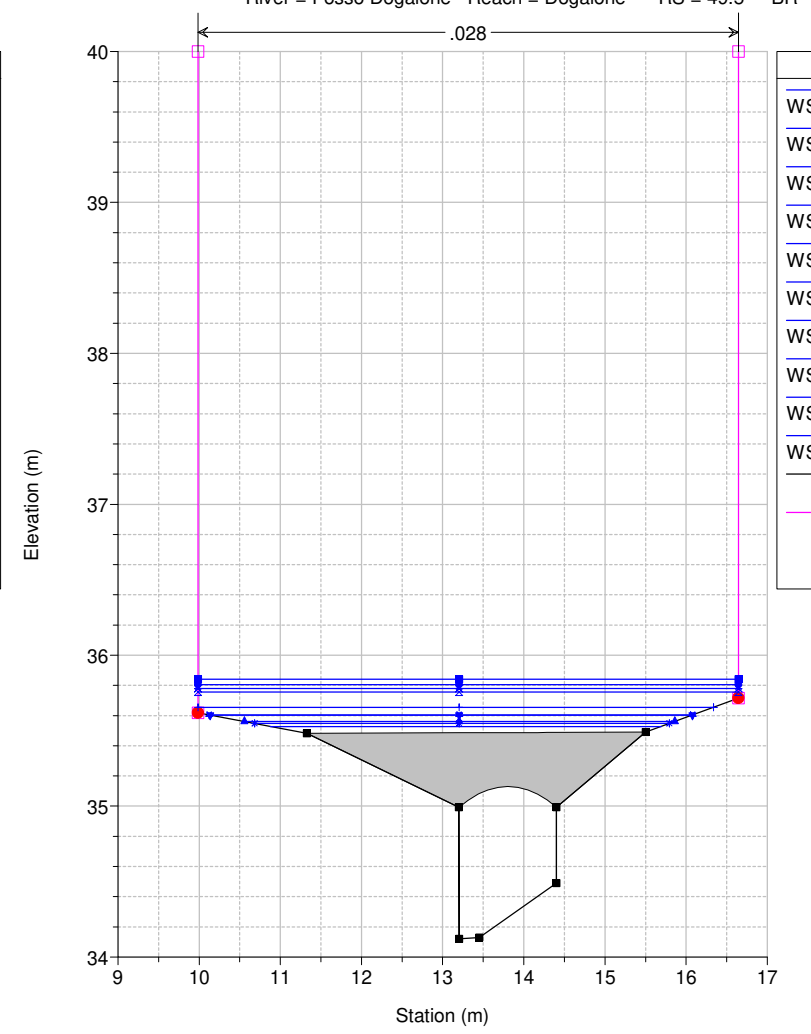

Legend

- WS Max WS - TR030_06_0
- WS Max WS - TR030_09_0
- WS Max WS - TR030_03_0
- WS Max WS - TR030_12_0
- WS Max WS - TR030_18_0
- WS Max WS - TR030_24_0
- WS Max WS - TR030_01_5
- WS Max WS - TR030_36_0
- WS Max WS - TR030_01_0
- WS Max WS - TR030_36_0
- WS Max WS - TR030_00_5
- Ground
- Levee
- Bank Sta

Studio Scandicci Torrenti Greve-Vingone
River = Fosso Dogaione Reach = Dogaione RS = 49.5 BR

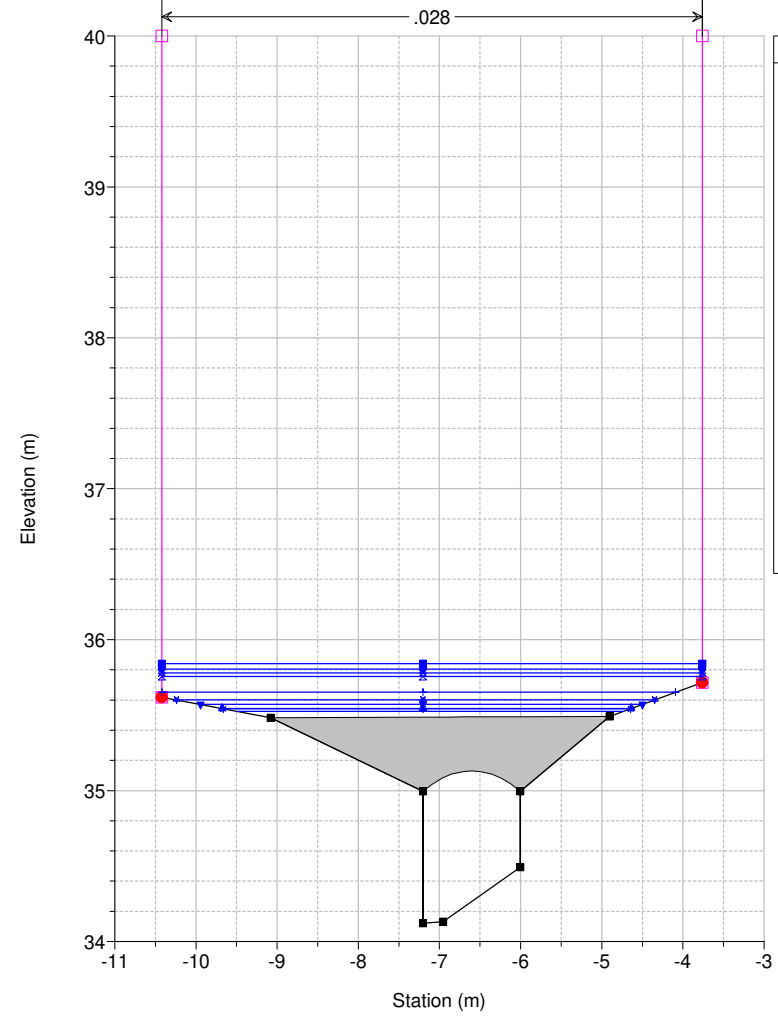

Legend

- WS Max WS - TR030_06_0
- WS Max WS - TR030_09_0
- WS Max WS - TR030_03_0
- WS Max WS - TR030_12_0
- WS Max WS - TR030_18_0
- WS Max WS - TR030_24_0
- WS Max WS - TR030_01_5
- WS Max WS - TR030_01_0
- WS Max WS - TR030_36_0
- WS Max WS - TR030_00_5
- Ground
- Levee
- Bank Sta

Studio Scandicci Torrenti Greve-Vingone
River = Fosso Dogaione Reach = Dogaione RS = 49 DG0009_C

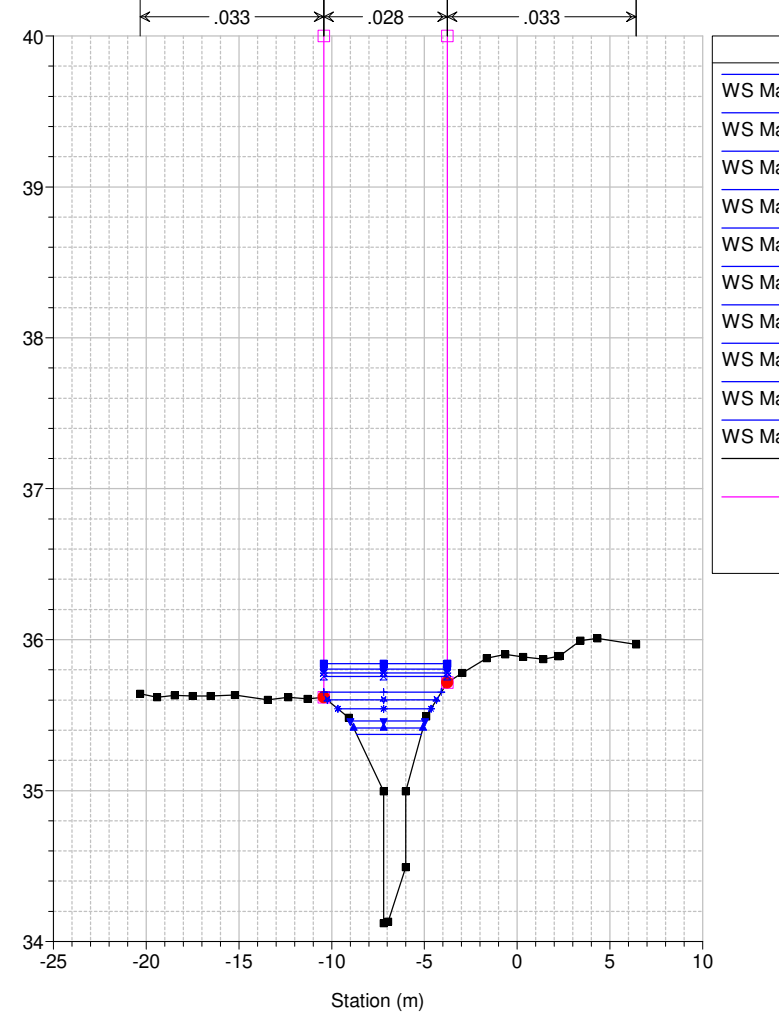

Legend

- WS Max WS - TR030_06_0
- WS Max WS - TR030_09_0
- WS Max WS - TR030_03_0
- WS Max WS - TR030_12_0
- WS Max WS - TR030_18_0
- WS Max WS - TR030_24_0
- WS Max WS - TR030_36_0
- WS Max WS - TR030_01_5
- WS Max WS - TR030_01_0
- WS Max WS - TR030_00_5
- Ground
- Levee
- Bank Sta

Studio Scandicci Torrenti Greve-Vingone
River = Fosso Dogaione Reach = Dogaione RS = 48 DG0009_D

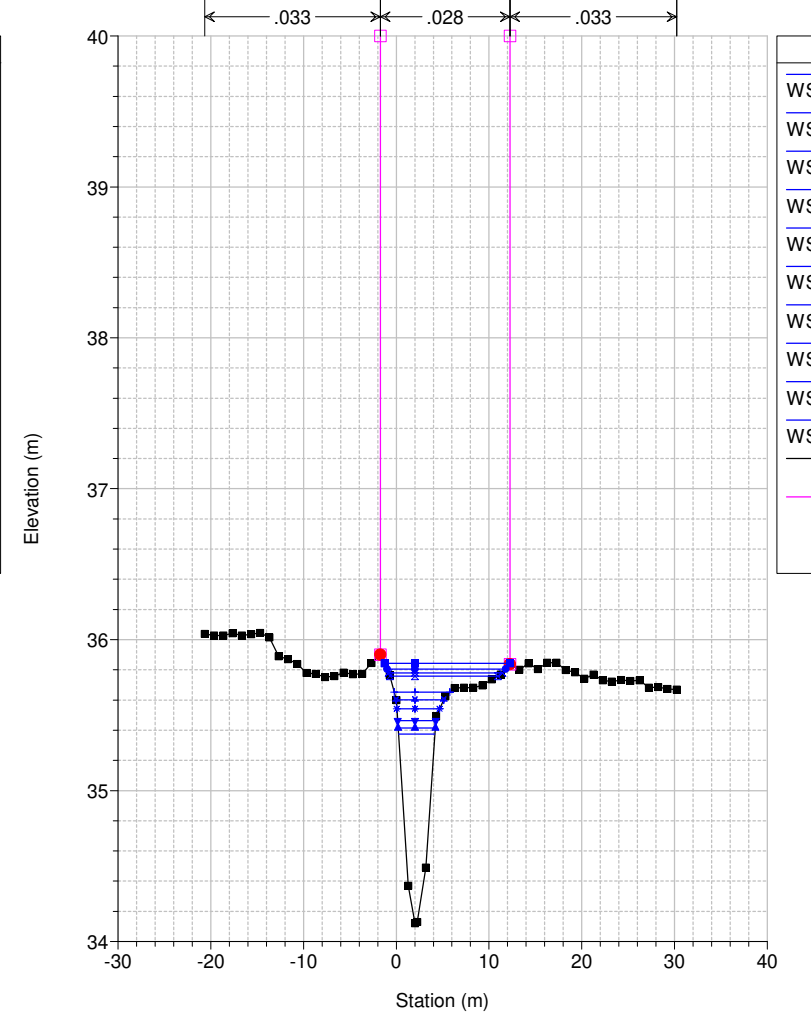

Legend

- WS Max WS - TR030_06_0
- WS Max WS - TR030_09_0
- WS Max WS - TR030_03_0
- WS Max WS - TR030_12_0
- WS Max WS - TR030_18_0
- WS Max WS - TR030_24_0
- WS Max WS - TR030_36_0
- WS Max WS - TR030_01_5
- WS Max WS - TR030_01_0
- WS Max WS - TR030_00_5
- Ground
- Levee
- Bank Sta

Studio Scandicci Torrenti Greve-Vingone
River = Fosso Dogaione Reach = Dogaione RS = 47 DG0010_A

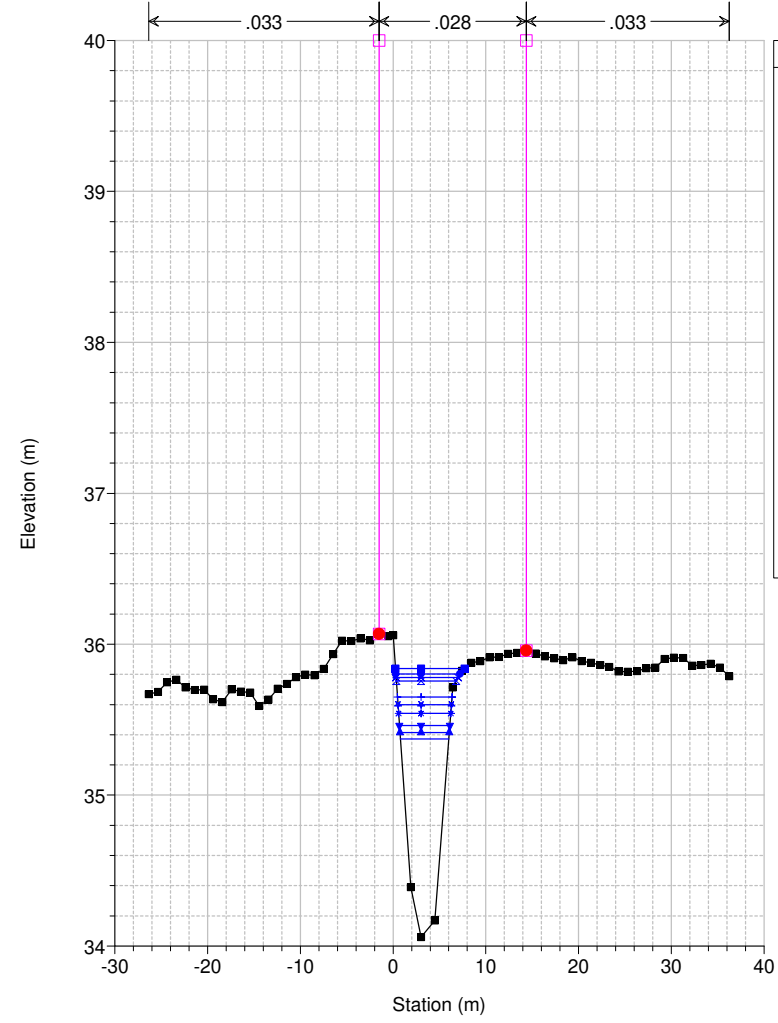

Legend	
WS Max WS - TR030_06_0	■
WS Max WS - TR030_09_0	●
WS Max WS - TR030_03_0	×
WS Max WS - TR030_12_0	+
WS Max WS - TR030_18_0	↑
WS Max WS - TR030_24_0	↓
WS Max WS - TR030_36_0	◆
WS Max WS - TR030_01_5	▼
WS Max WS - TR030_01_0	▲
WS Max WS - TR030_00_5	▽
Ground	■
Levee	□
Bank Sta	●

Studio Scandicci Torrenti Greve-Vingone
River = Fosso Dogaione Reach = Dogaione RS = 46 DG0010_B

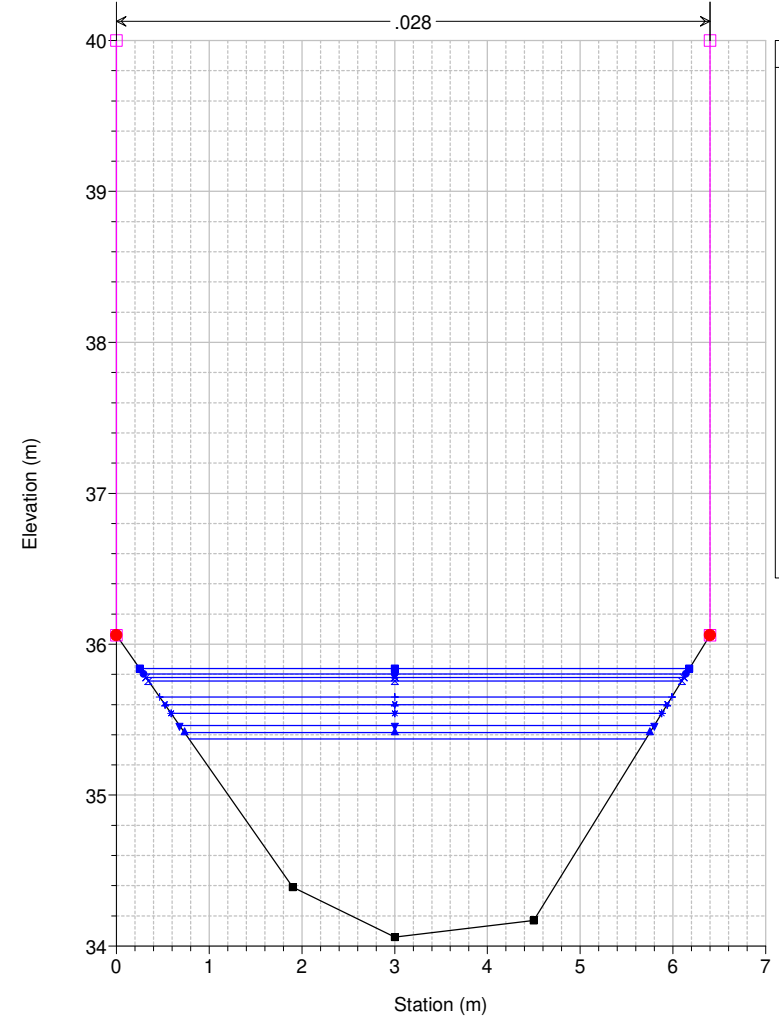

Legend	
WS Max WS - TR030_06_0	■
WS Max WS - TR030_09_0	●
WS Max WS - TR030_03_0	×
WS Max WS - TR030_12_0	+
WS Max WS - TR030_18_0	↑
WS Max WS - TR030_24_0	↓
WS Max WS - TR030_36_0	◆
WS Max WS - TR030_01_5	▼
WS Max WS - TR030_01_0	▲
WS Max WS - TR030_00_5	▽
Ground	■
Levee	□
Bank Sta	●

Studio Scandicci Torrenti Greve-Vingone
River = Fosso Dogaione Reach = Dogaione RS = 45.5 BR

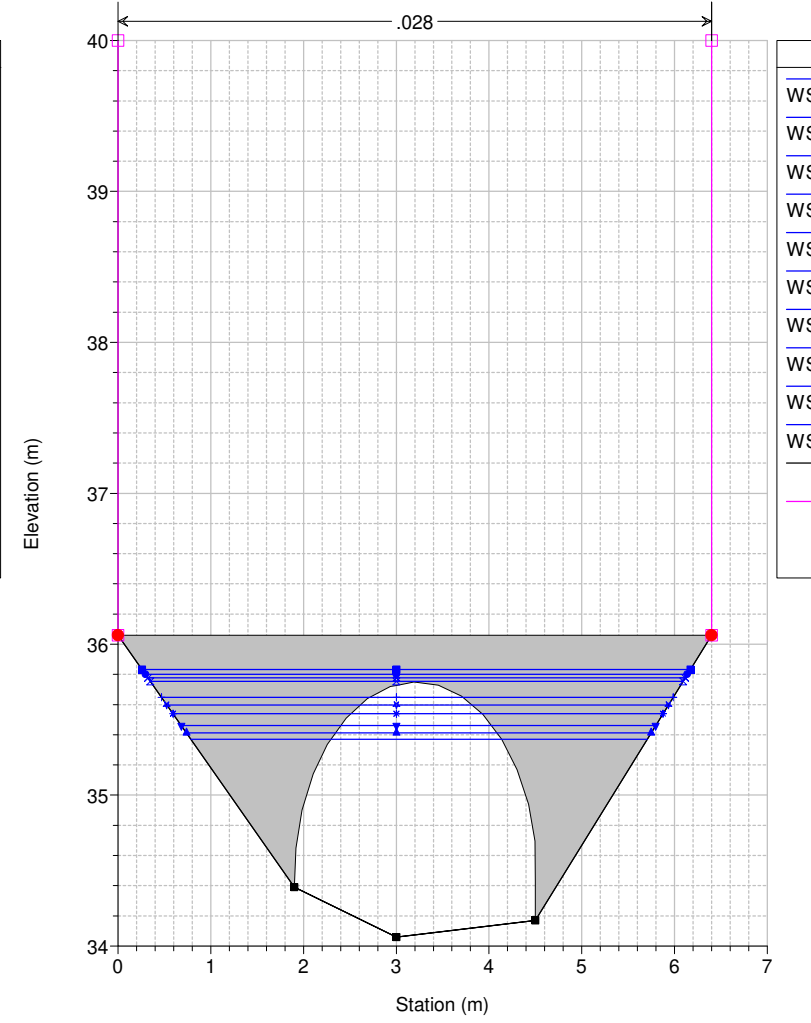

Legend	
WS Max WS - TR030_06_0	■
WS Max WS - TR030_09_0	●
WS Max WS - TR030_03_0	×
WS Max WS - TR030_12_0	+
WS Max WS - TR030_18_0	↑
WS Max WS - TR030_24_0	↓
WS Max WS - TR030_36_0	◆
WS Max WS - TR030_01_5	▼
WS Max WS - TR030_01_0	▲
WS Max WS - TR030_00_5	▽
Ground	■
Levee	□
Bank Sta	●

Studio Scandicci Torrenti Greve-Vingone
River = Fosso Dogaione Reach = Dogaione RS = 45.5 BR

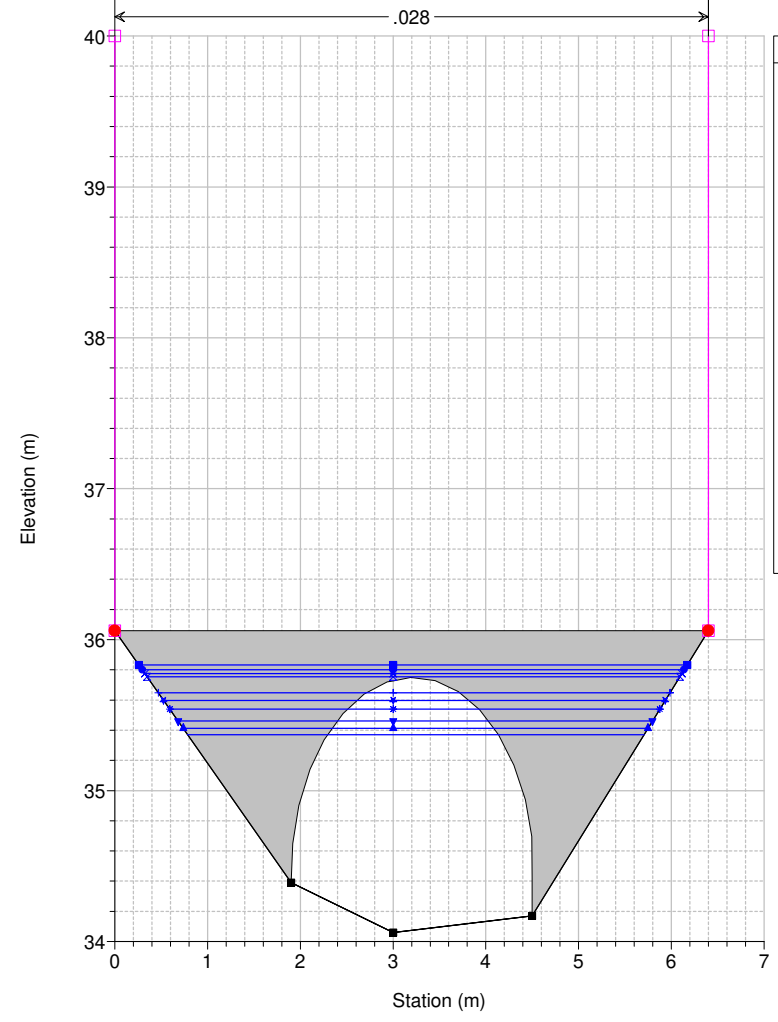

Legend	
WS Max WS - TR030_06_0	■
WS Max WS - TR030_09_0	●
WS Max WS - TR030_03_0	×
WS Max WS - TR030_12_0	+
WS Max WS - TR030_18_0	↑
WS Max WS - TR030_24_0	↓
WS Max WS - TR030_36_0	◆
WS Max WS - TR030_01_5	▼
WS Max WS - TR030_01_0	▲
WS Max WS - TR030_00_5	▽
Ground	■
Levee	□
Bank Sta	●

Studio Scandicci Torrenti Greve-Vingone
River = Fosso Dogaione Reach = Dogaione RS = 45 DG0010_C

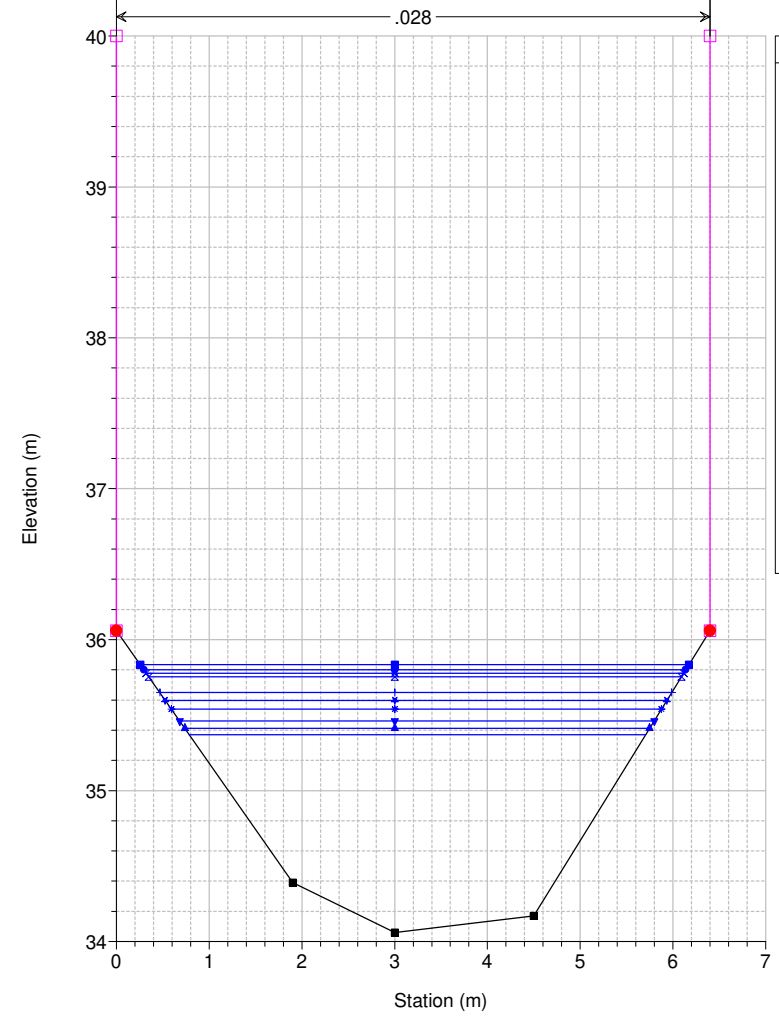

Legend	
WS Max WS - TR030_06_0	■
WS Max WS - TR030_09_0	●
WS Max WS - TR030_03_0	×
WS Max WS - TR030_12_0	+
WS Max WS - TR030_18_0	↑
WS Max WS - TR030_24_0	↓
WS Max WS - TR030_36_0	◆
WS Max WS - TR030_01_5	▼
WS Max WS - TR030_01_0	▲
WS Max WS - TR030_00_5	▽
Ground	■
Levee	□
Bank Sta	●

Studio Scandicci Torrenti Greve-Vingone
River = Fosso Dogaione Reach = Dogaione RS = 44 DG0010_D

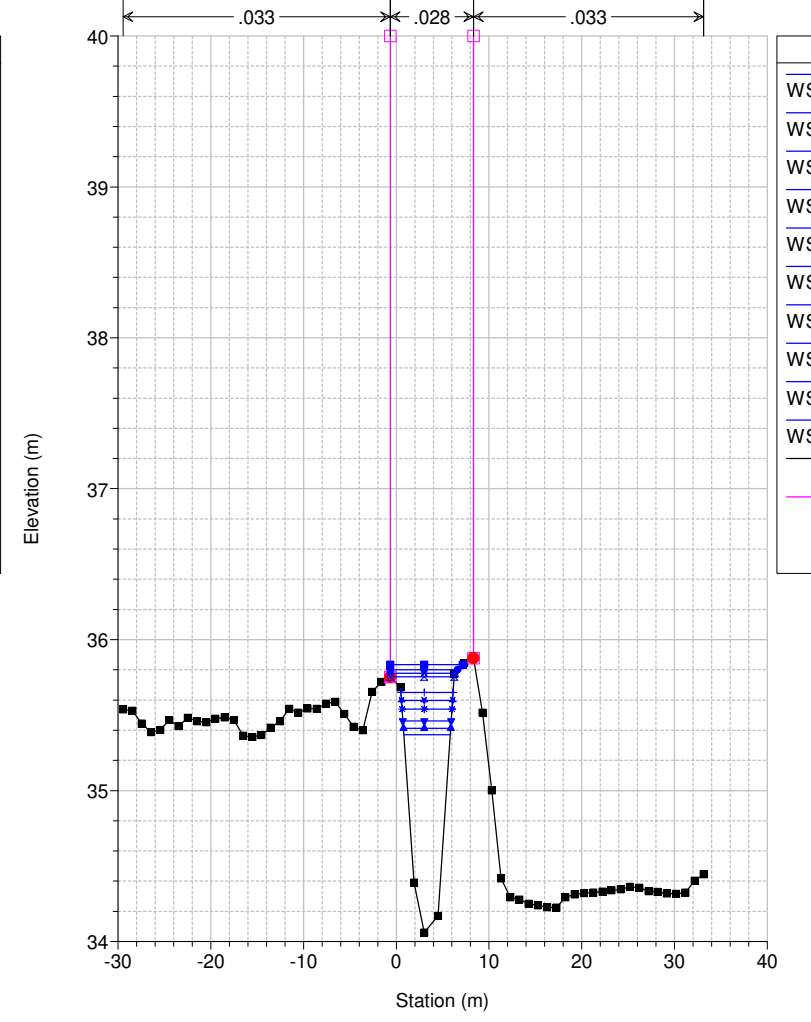

Legend	
WS Max WS - TR030_06_0	■
WS Max WS - TR030_09_0	●
WS Max WS - TR030_03_0	×
WS Max WS - TR030_12_0	+
WS Max WS - TR030_18_0	↑
WS Max WS - TR030_24_0	↓
WS Max WS - TR030_36_0	◆
WS Max WS - TR030_01_5	▼
WS Max WS - TR030_01_0	▲
WS Max WS - TR030_00_5	▽
Ground	■
Levee	□
Bank Sta	●

Studio Scandicci Torrenti Greve-Vingone
River = Fosso Dogaione Reach = Dogaione RS = 43 DG1011_A

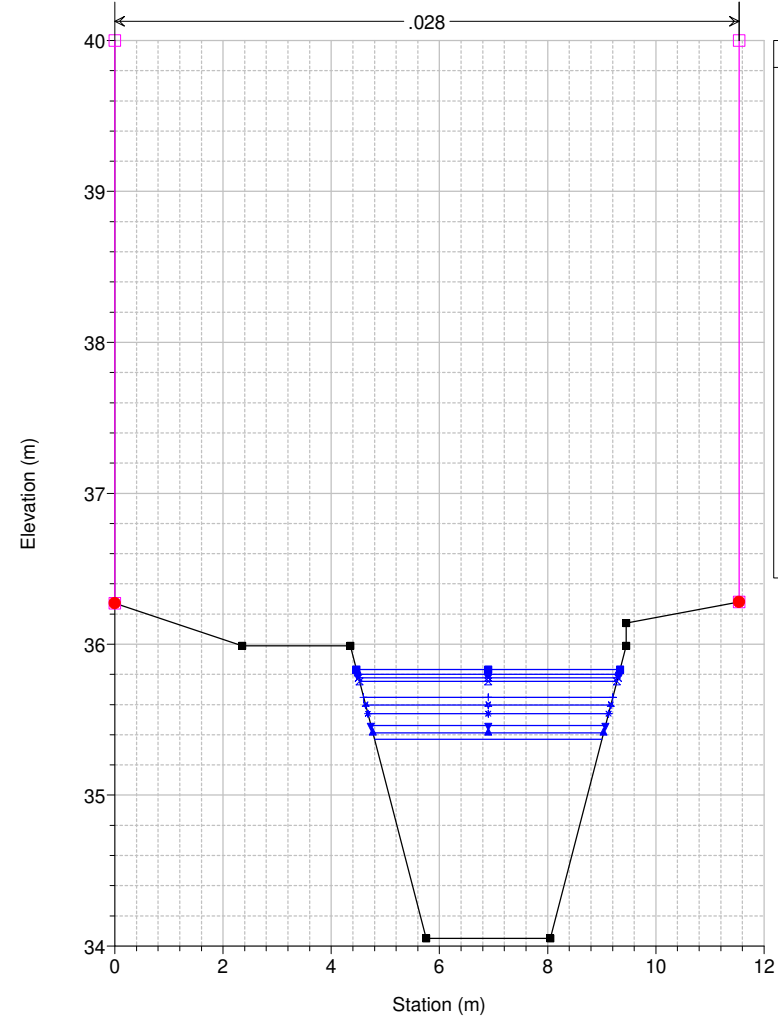

Legend

- WS Max WS - TR030_06_0
- WS Max WS - TR030_09_0
- WS Max WS - TR030_03_0
- WS Max WS - TR030_12_0
- WS Max WS - TR030_18_0
- WS Max WS - TR030_24_0
- WS Max WS - TR030_36_0
- WS Max WS - TR030_01_5
- WS Max WS - TR030_01_0
- WS Max WS - TR030_00_5
- Ground
- Levee
- Bank Sta

Studio Scandicci Torrenti Greve-Vingone
River = Fosso Dogaione Reach = Dogaione RS = 42 DG1011_B

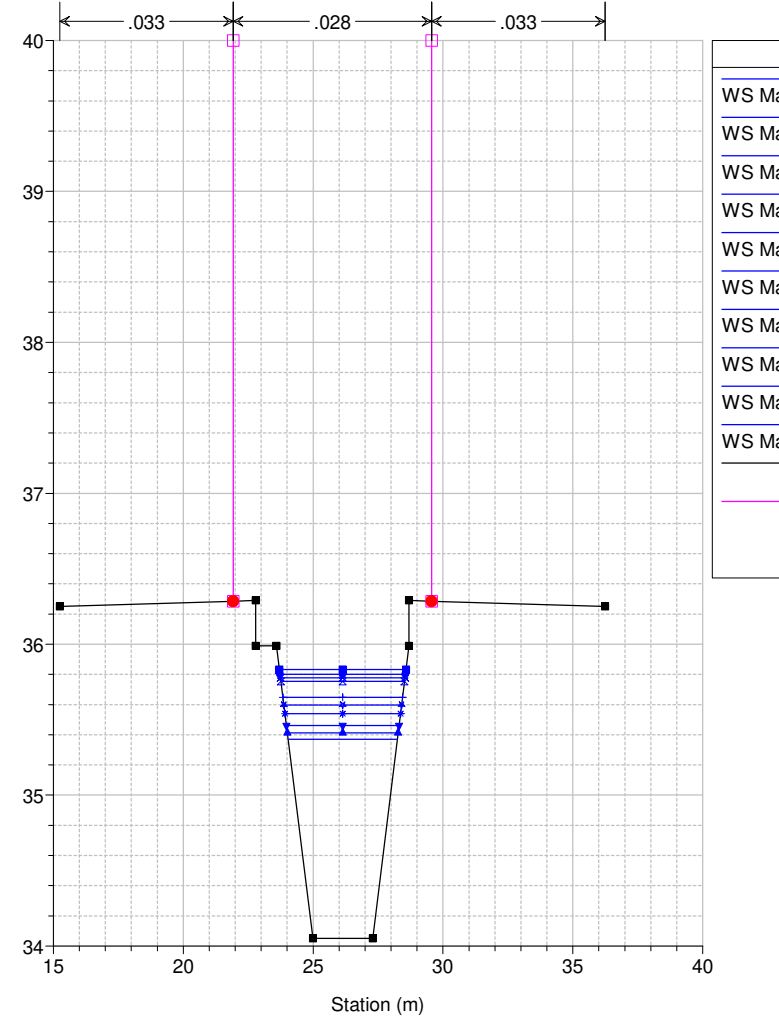

Legend

- WS Max WS - TR030_06_0
- WS Max WS - TR030_09_0
- WS Max WS - TR030_03_0
- WS Max WS - TR030_12_0
- WS Max WS - TR030_18_0
- WS Max WS - TR030_24_0
- WS Max WS - TR030_36_0
- WS Max WS - TR030_01_5
- WS Max WS - TR030_01_0
- WS Max WS - TR030_00_5
- Ground
- Levee
- Bank Sta

Studio Scandicci Torrenti Greve-Vingone
River = Fosso Dogaione Reach = Dogaione RS = 41.5 BR

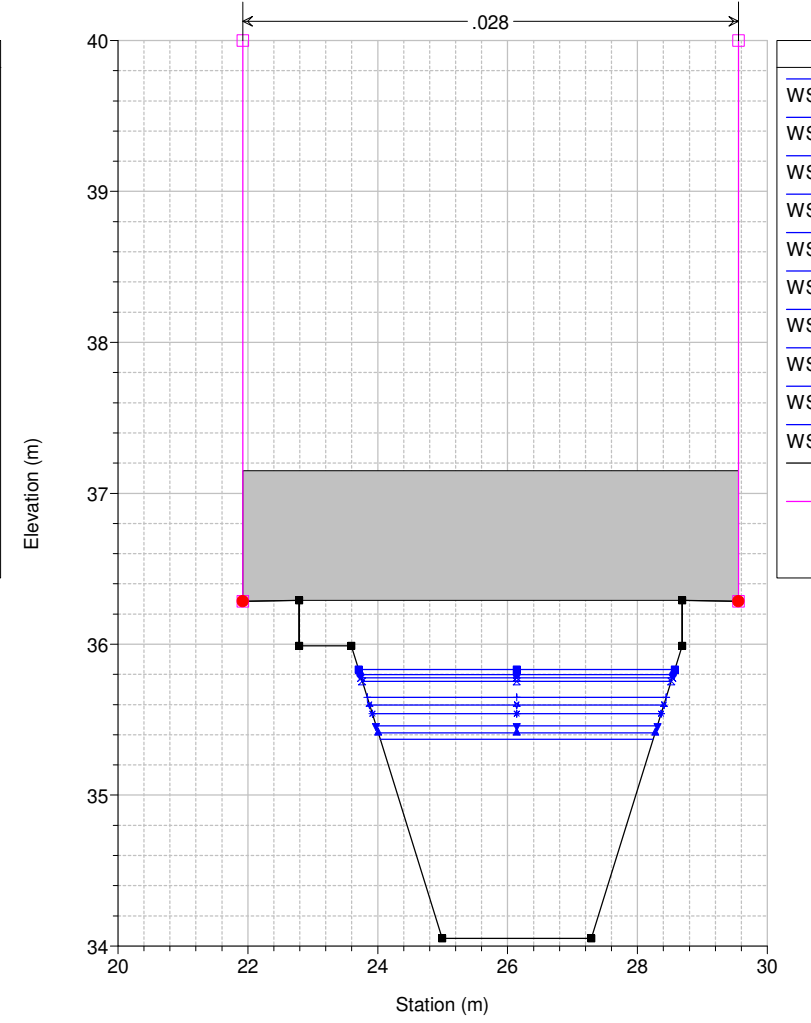

Legend

- WS Max WS - TR030_06_0
- WS Max WS - TR030_09_0
- WS Max WS - TR030_03_0
- WS Max WS - TR030_12_0
- WS Max WS - TR030_18_0
- WS Max WS - TR030_24_0
- WS Max WS - TR030_36_0
- WS Max WS - TR030_01_5
- WS Max WS - TR030_01_0
- WS Max WS - TR030_00_5
- Ground
- Levee
- Bank Sta

Studio Scandicci Torrenti Greve-Vingone
River = Fosso Dogaione Reach = Dogaione RS = 41.5 BR

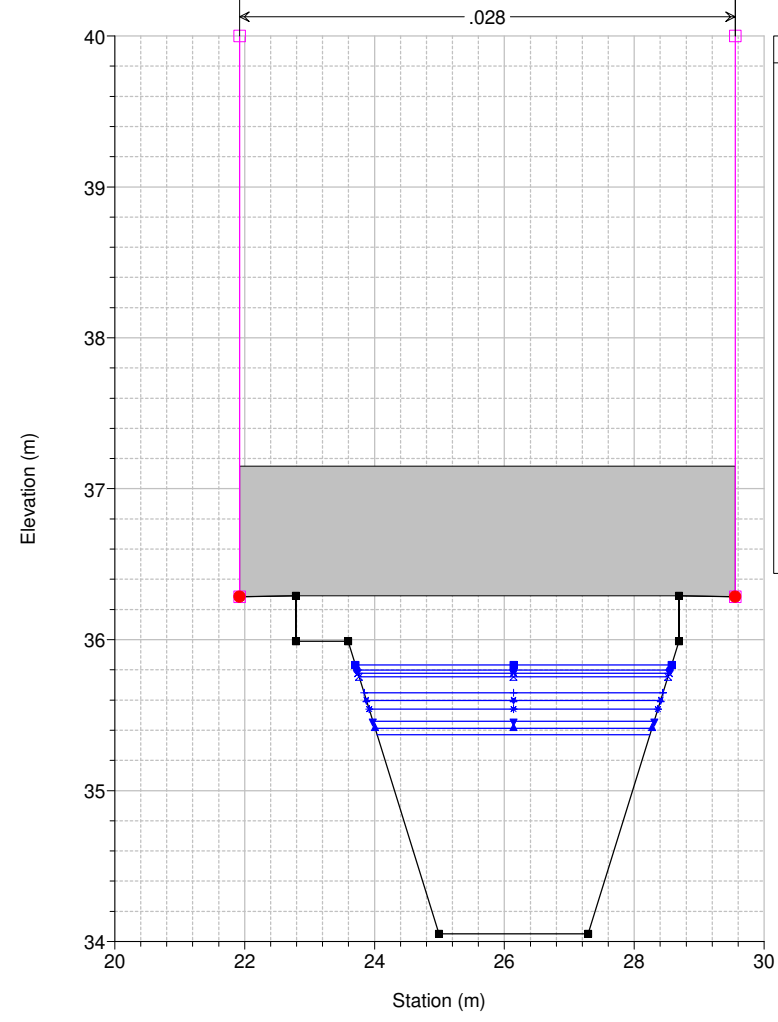

Legend

- WS Max WS - TR030_06_0
- WS Max WS - TR030_09_0
- WS Max WS - TR030_03_0
- WS Max WS - TR030_12_0
- WS Max WS - TR030_18_0
- WS Max WS - TR030_24_0
- WS Max WS - TR030_36_0
- WS Max WS - TR030_01_5
- WS Max WS - TR030_01_0
- WS Max WS - TR030_00_5
- Ground
- Levee
- Bank Sta

Studio Scandicci Torrenti Greve-Vingone
River = Fosso Dogaione Reach = Dogaione RS = 41 DG1011_C

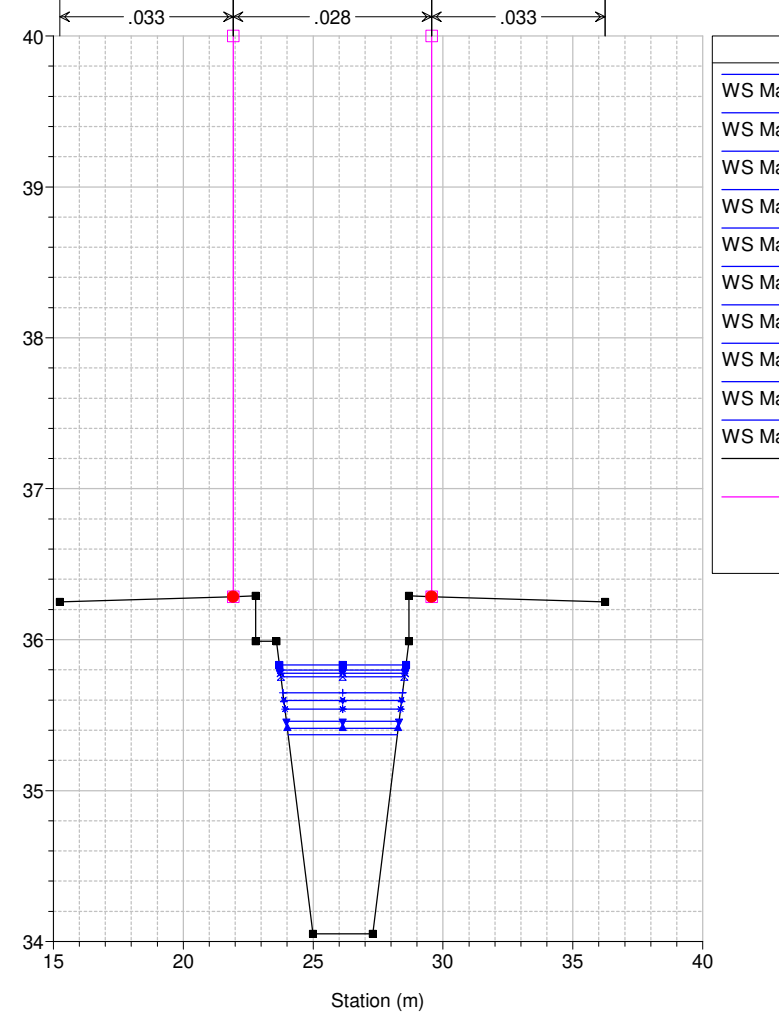

Legend

- WS Max WS - TR030_06_0
- WS Max WS - TR030_09_0
- WS Max WS - TR030_03_0
- WS Max WS - TR030_12_0
- WS Max WS - TR030_18_0
- WS Max WS - TR030_24_0
- WS Max WS - TR030_36_0
- WS Max WS - TR030_01_5
- WS Max WS - TR030_01_0
- WS Max WS - TR030_00_5
- Ground
- Levee
- Bank Sta

Studio Scandicci Torrenti Greve-Vingone
River = Fosso Dogaione Reach = Dogaione RS = 40 DG1011_D

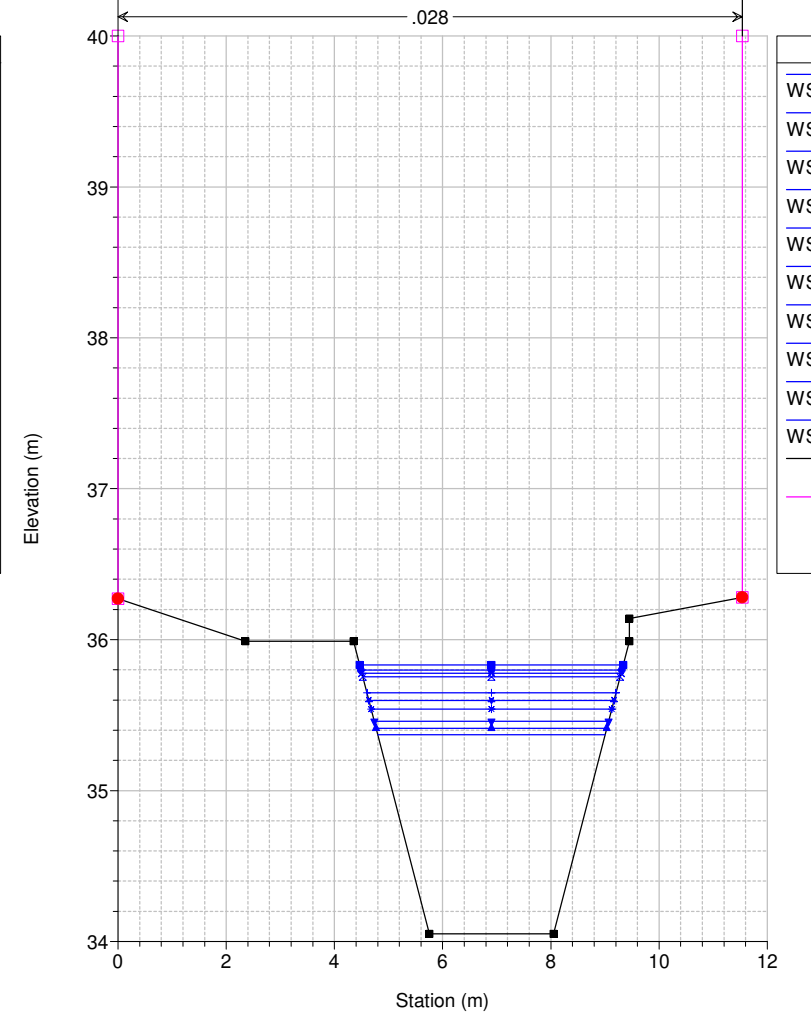

Legend

- WS Max WS - TR030_06_0
- WS Max WS - TR030_09_0
- WS Max WS - TR030_03_0
- WS Max WS - TR030_12_0
- WS Max WS - TR030_18_0
- WS Max WS - TR030_24_0
- WS Max WS - TR030_36_0
- WS Max WS - TR030_01_5
- WS Max WS - TR030_01_0
- WS Max WS - TR030_00_5
- Ground
- Levee
- Bank Sta

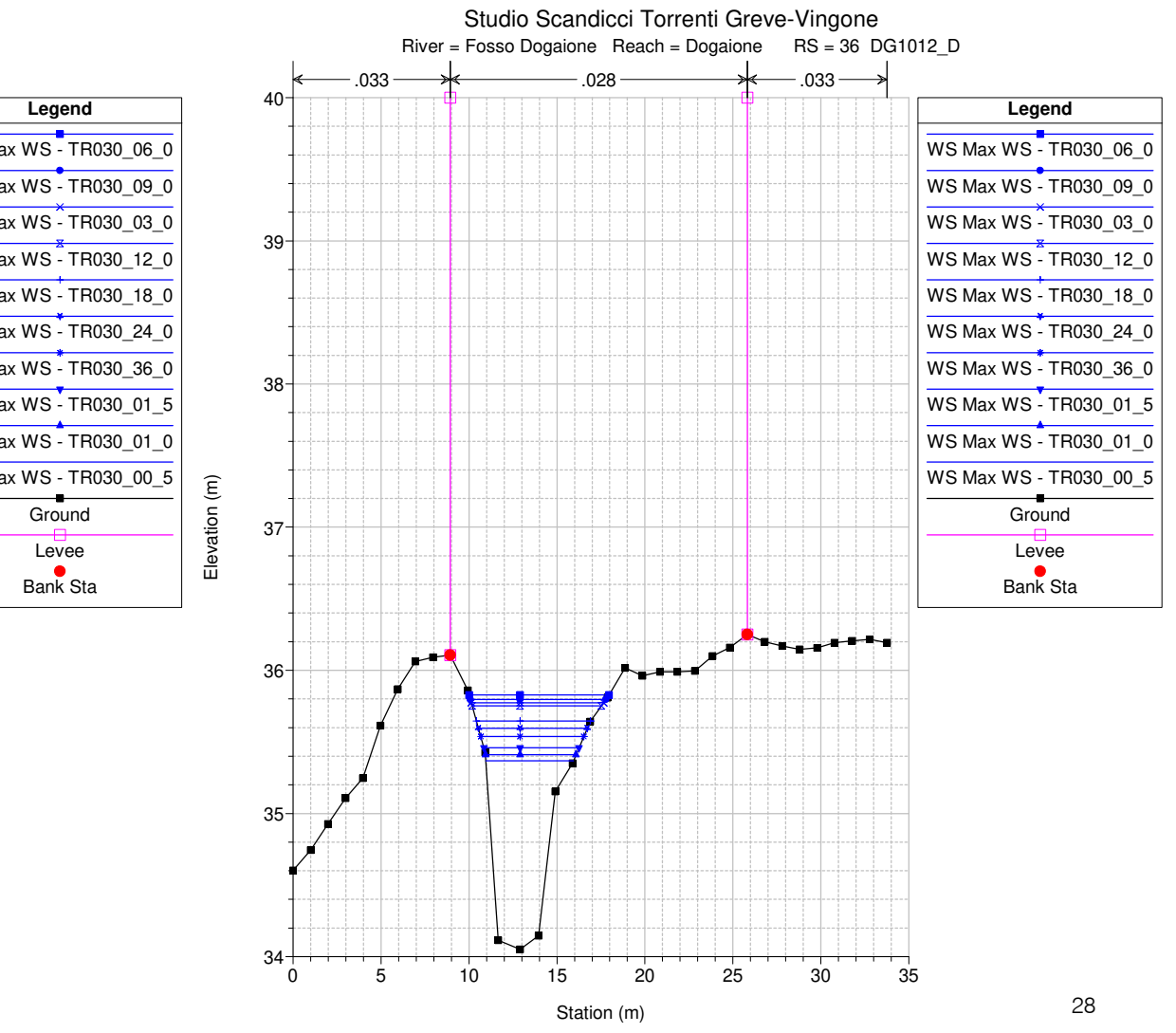
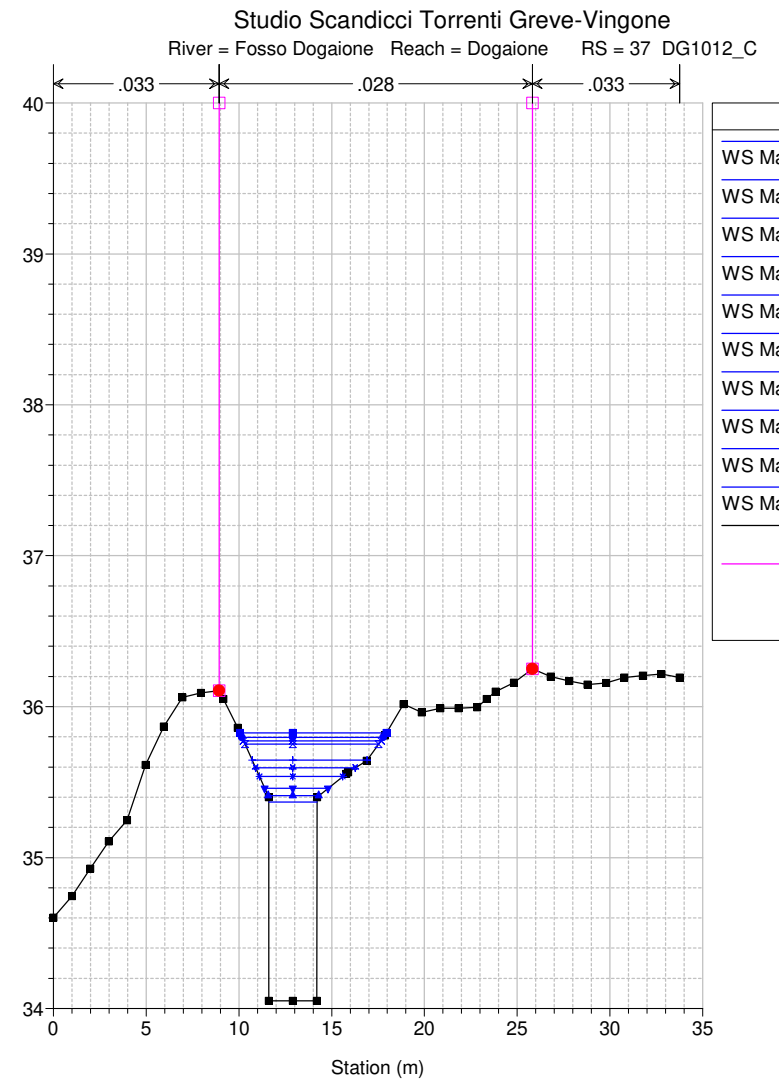
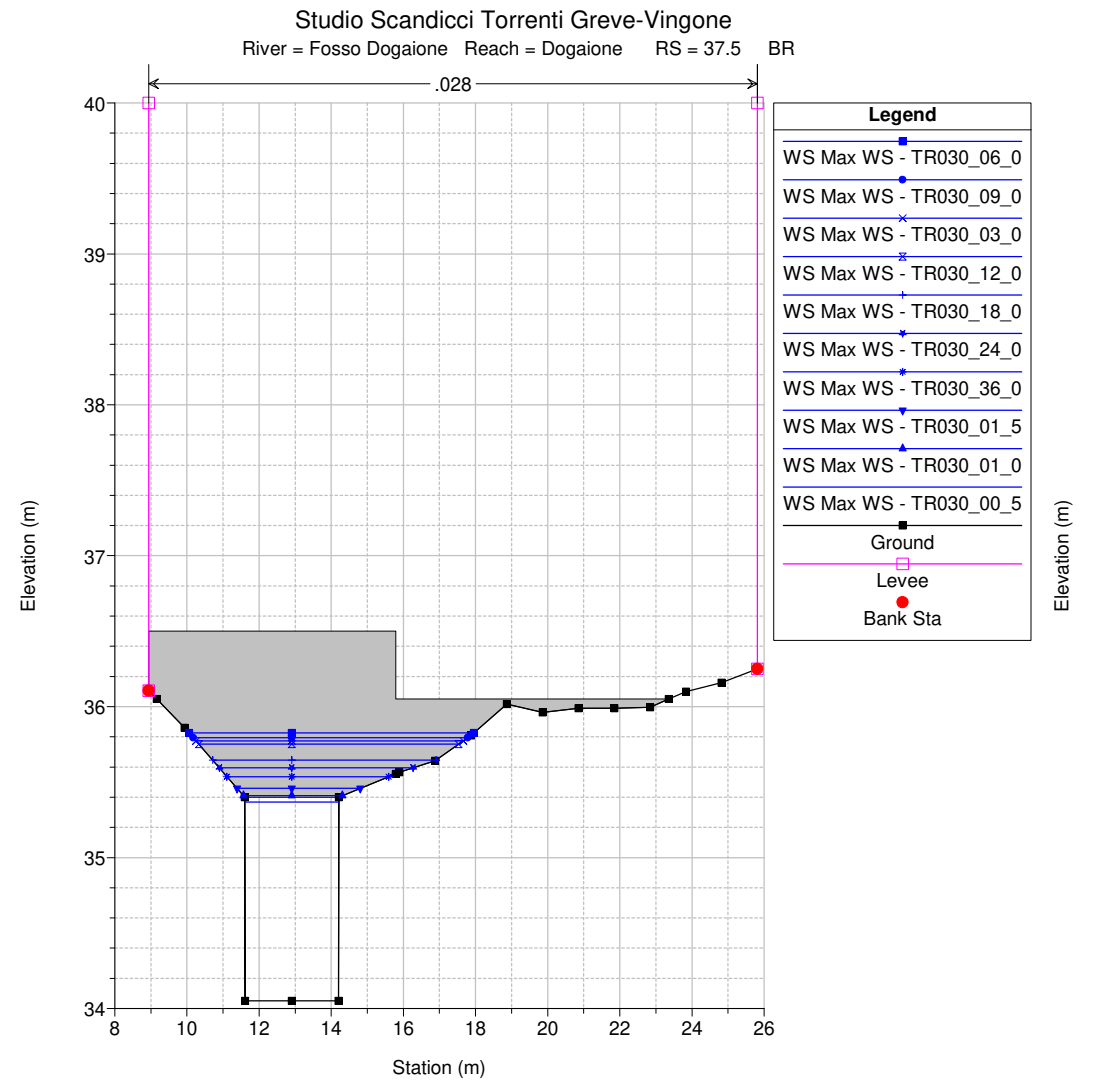
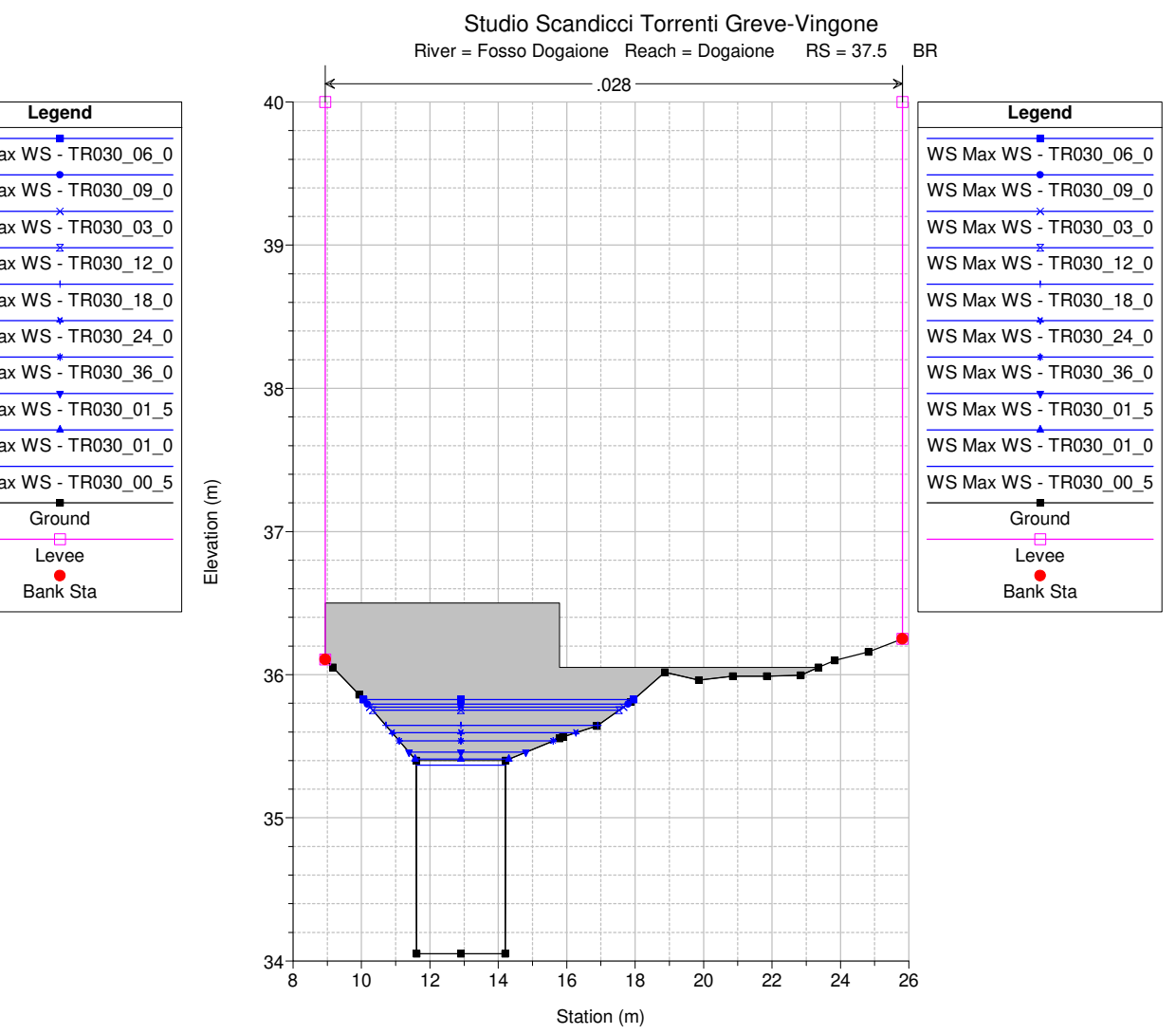
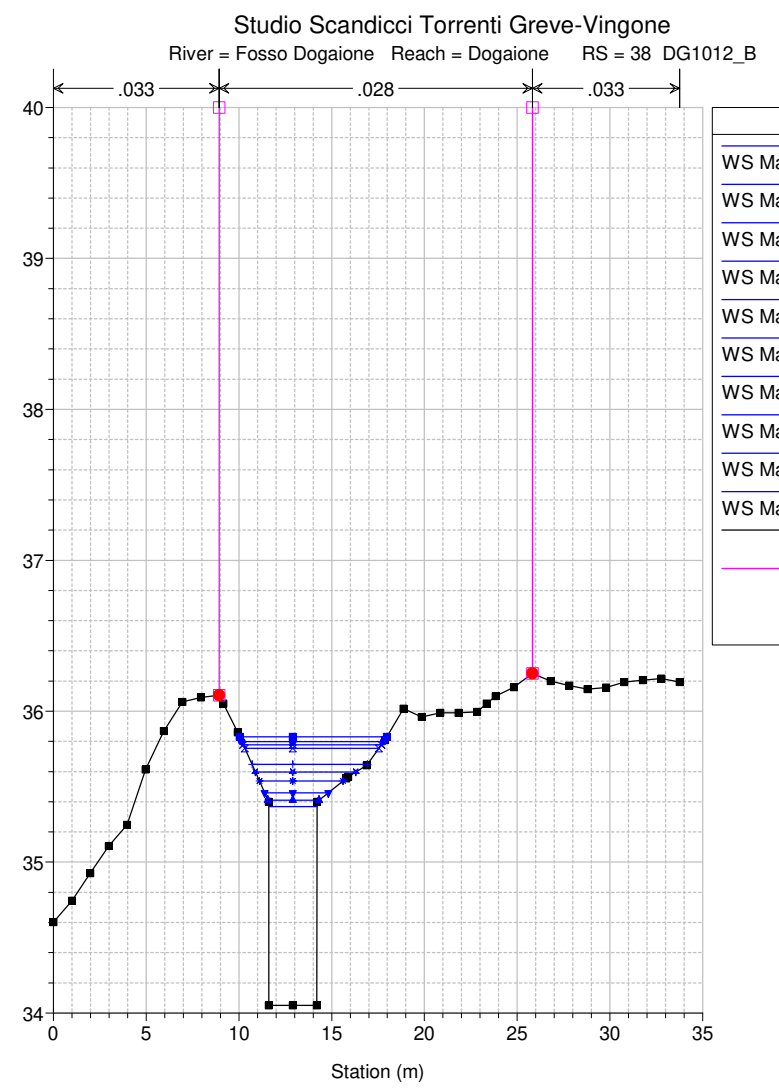
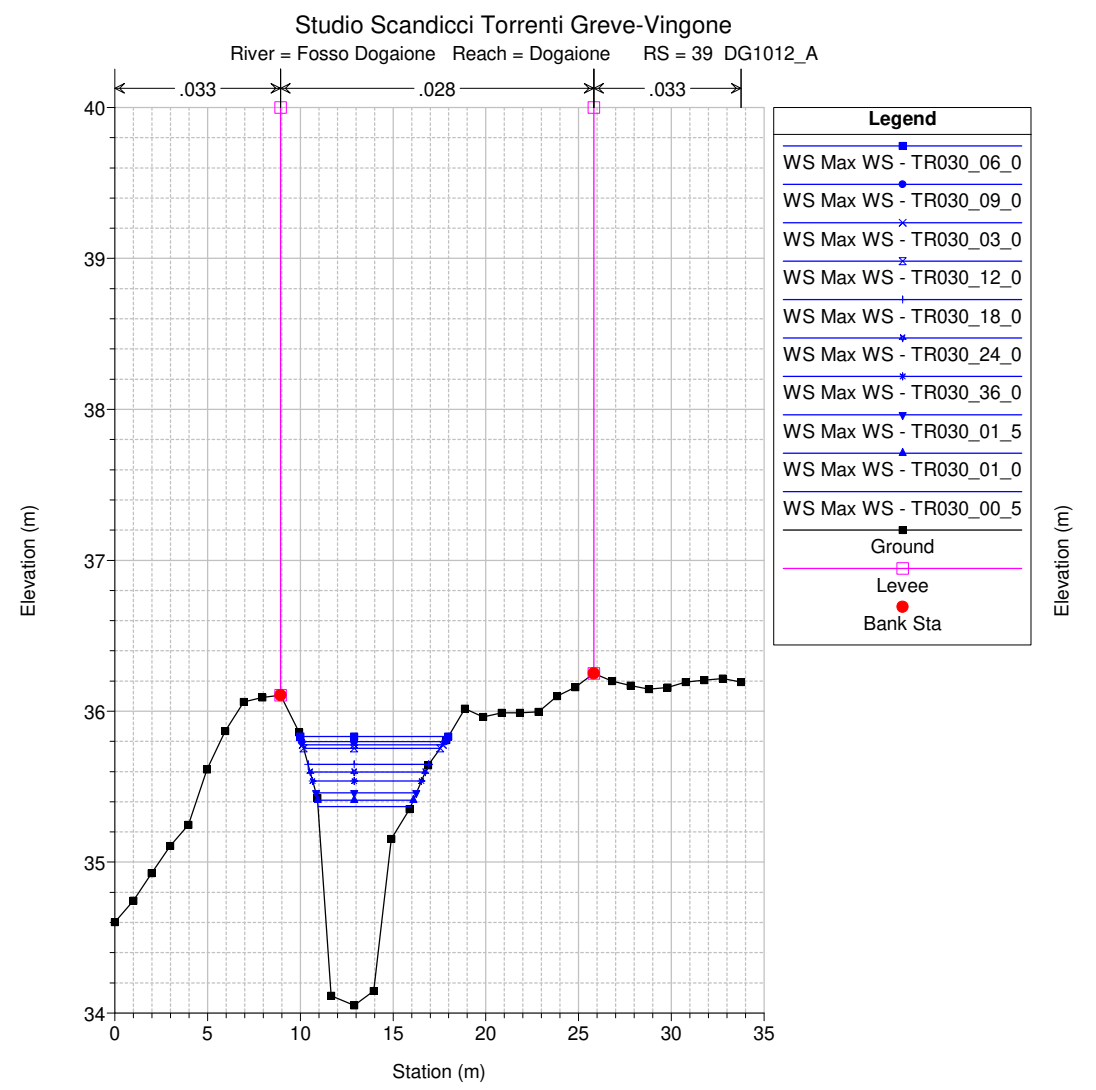

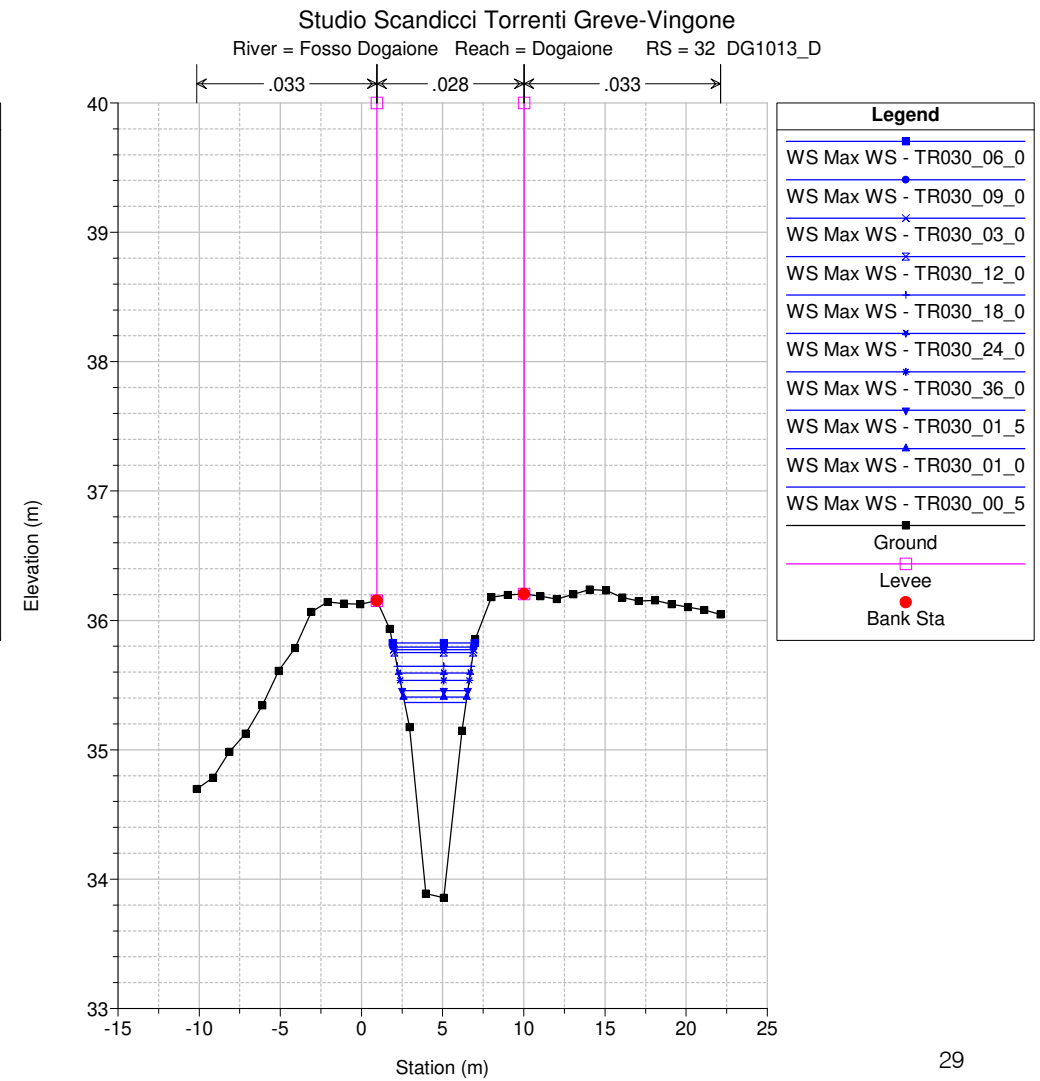
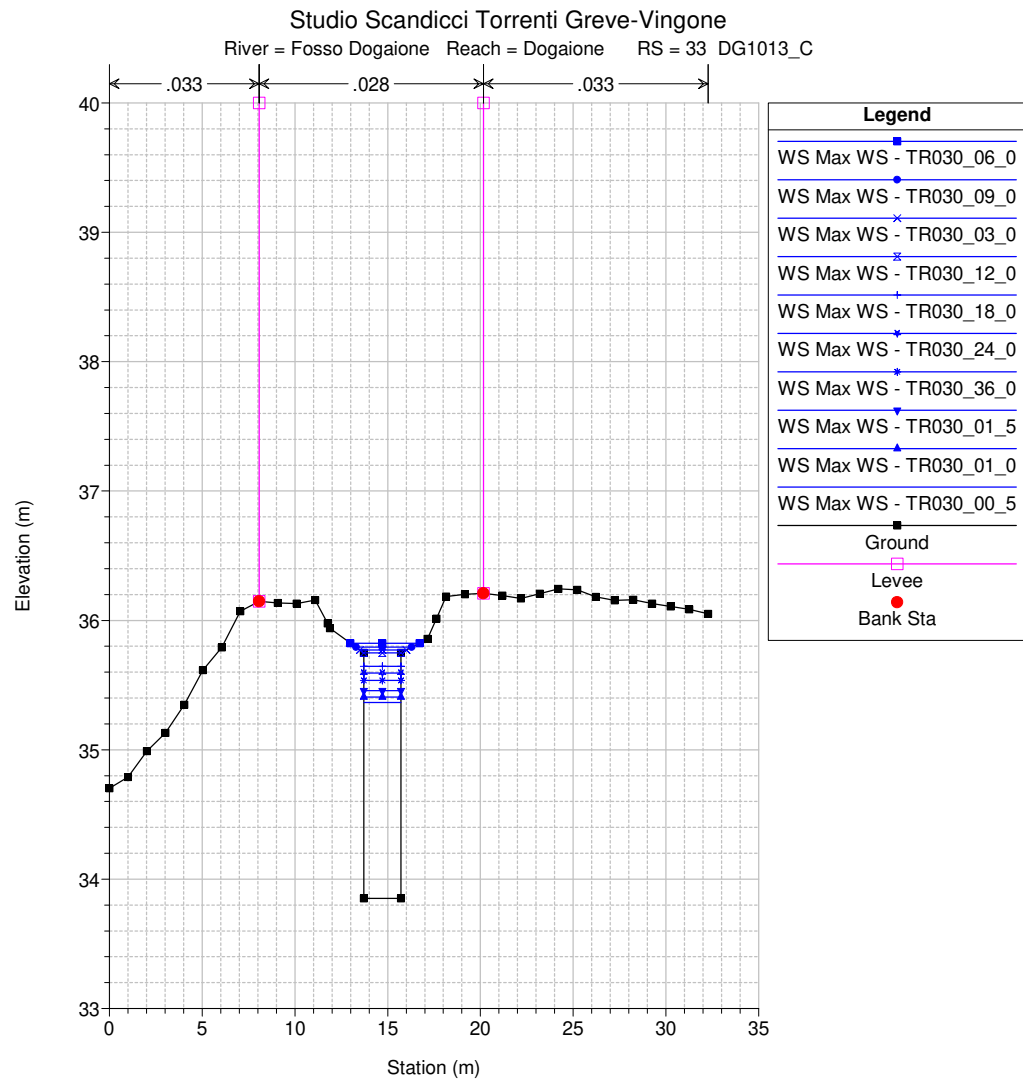
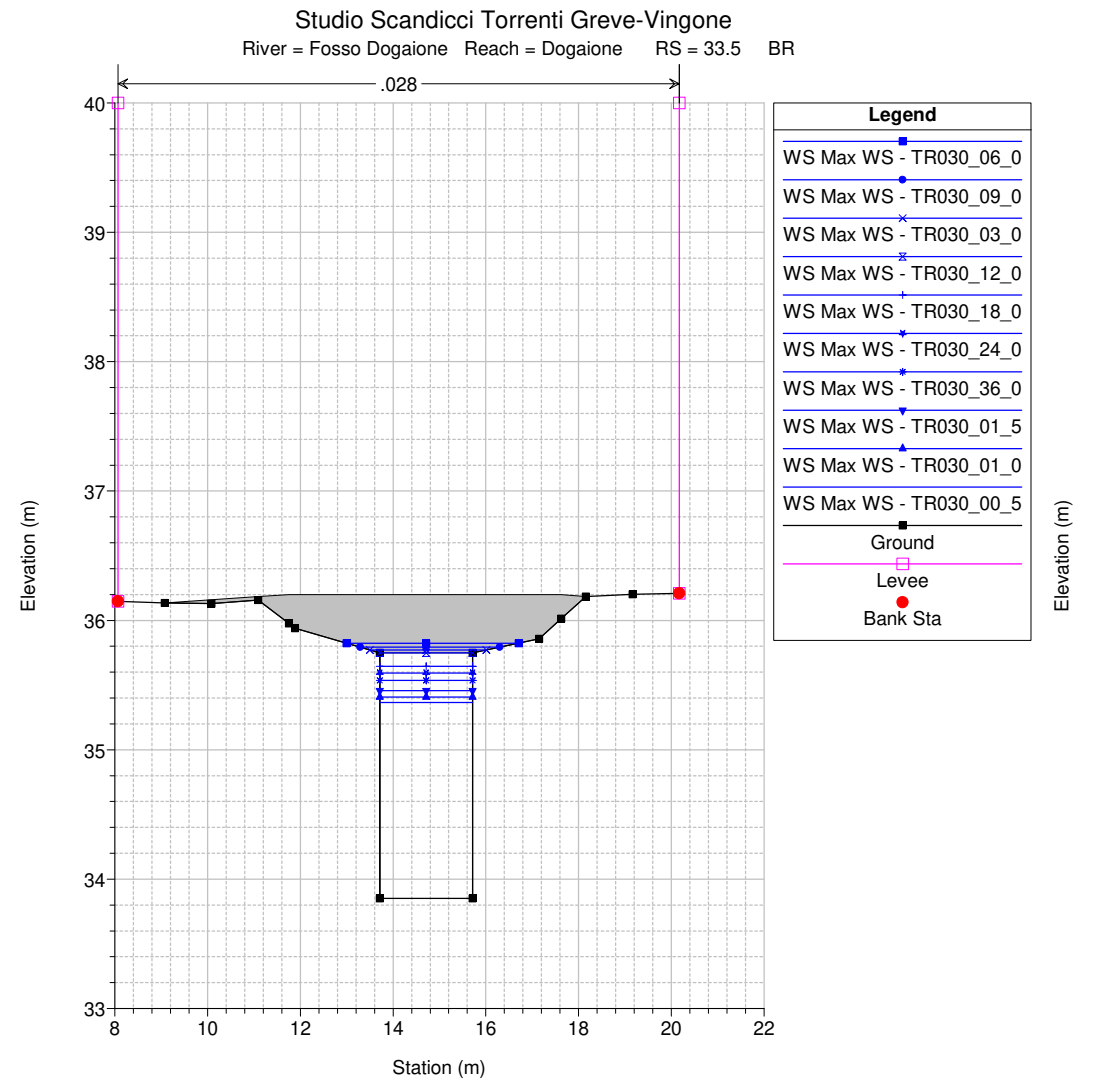
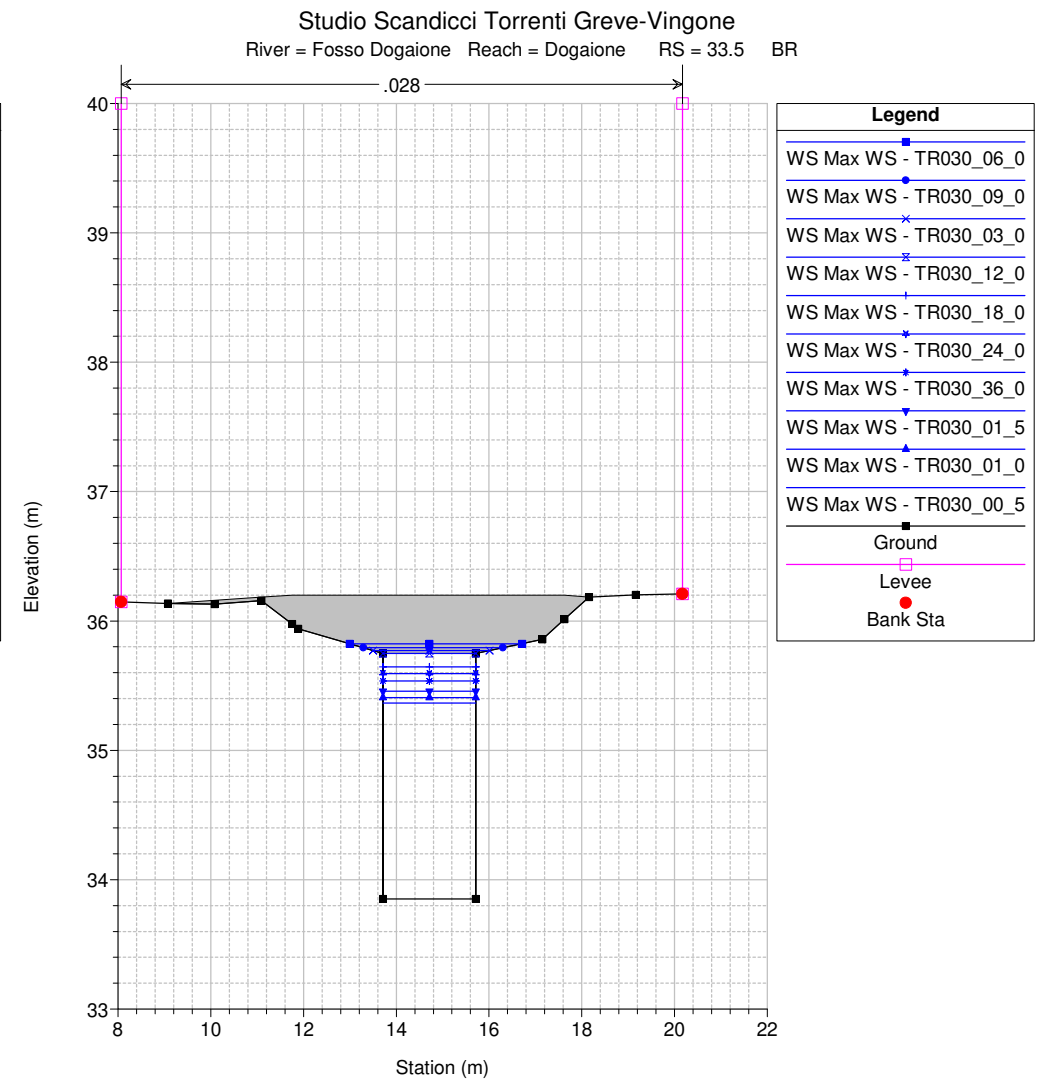
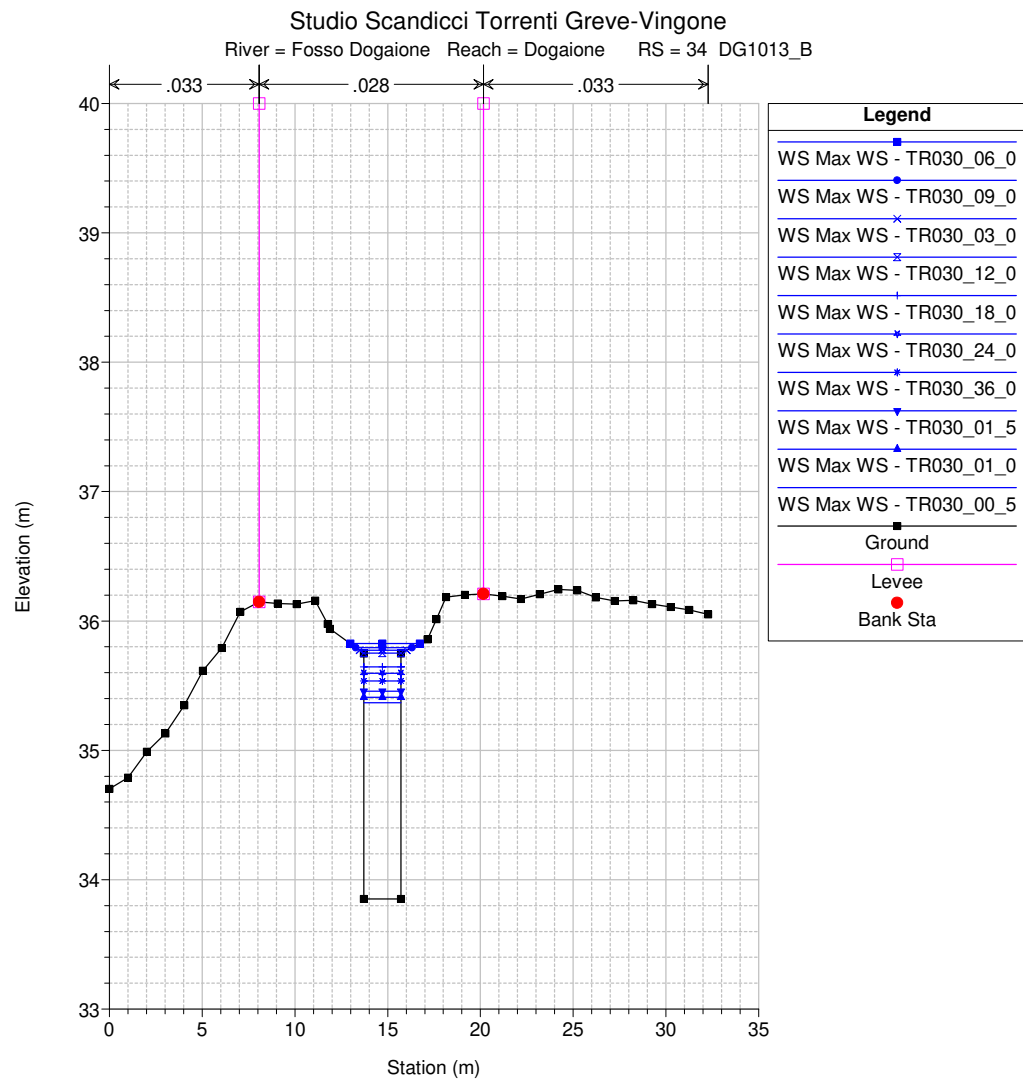
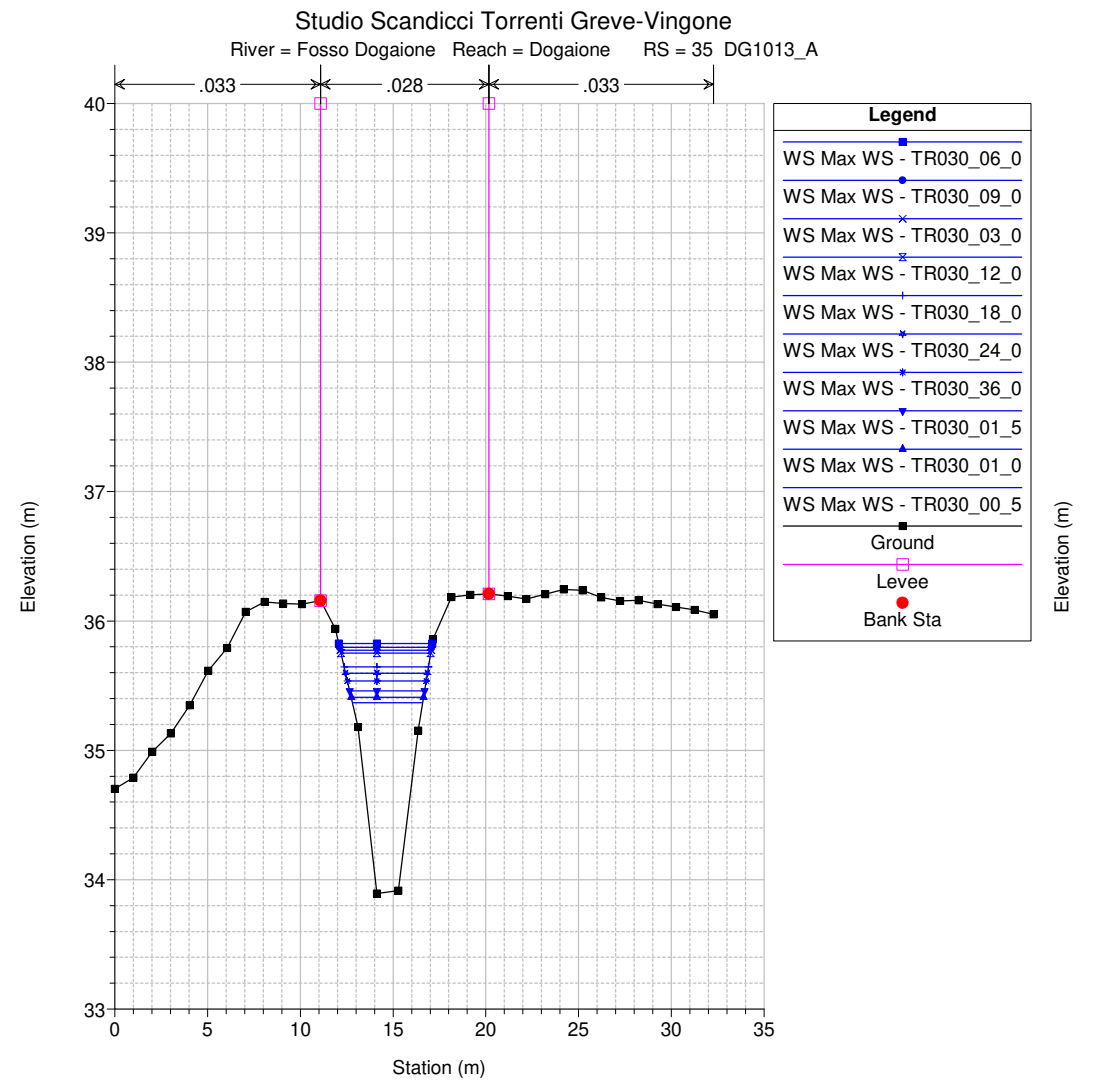

Studio Scandicci Torrenti Greve-Vingone
River = Fosso Dogaione Reach = Dogaione RS = 31 DG1014_A

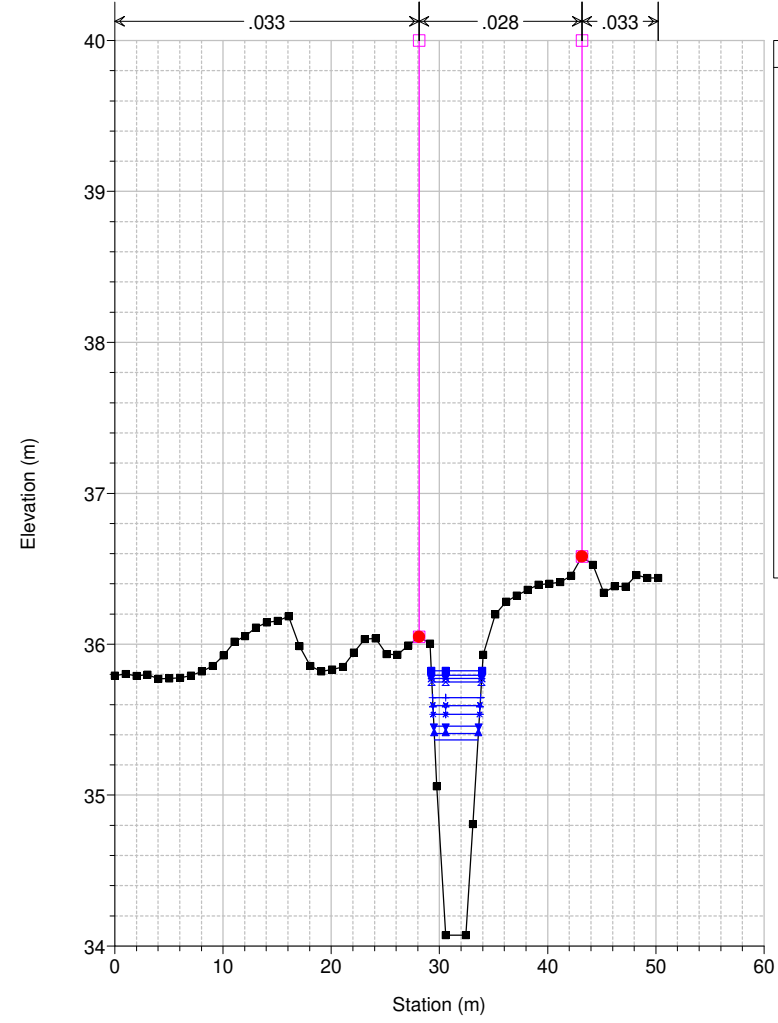

Legend	
WS Max WS - TR030_06_0	■
WS Max WS - TR030_09_0	●
WS Max WS - TR030_03_0	×
WS Max WS - TR030_12_0	+
WS Max WS - TR030_18_0	↑
WS Max WS - TR030_24_0	↓
WS Max WS - TR030_36_0	◆
WS Max WS - TR030_01_5	▼
WS Max WS - TR030_01_0	▲
WS Max WS - TR030_00_5	◆
Ground	■
Levee	□
Bank Sta	●

Studio Scandicci Torrenti Greve-Vingone
River = Fosso Dogaione Reach = Dogaione RS = 30 DG1014_B

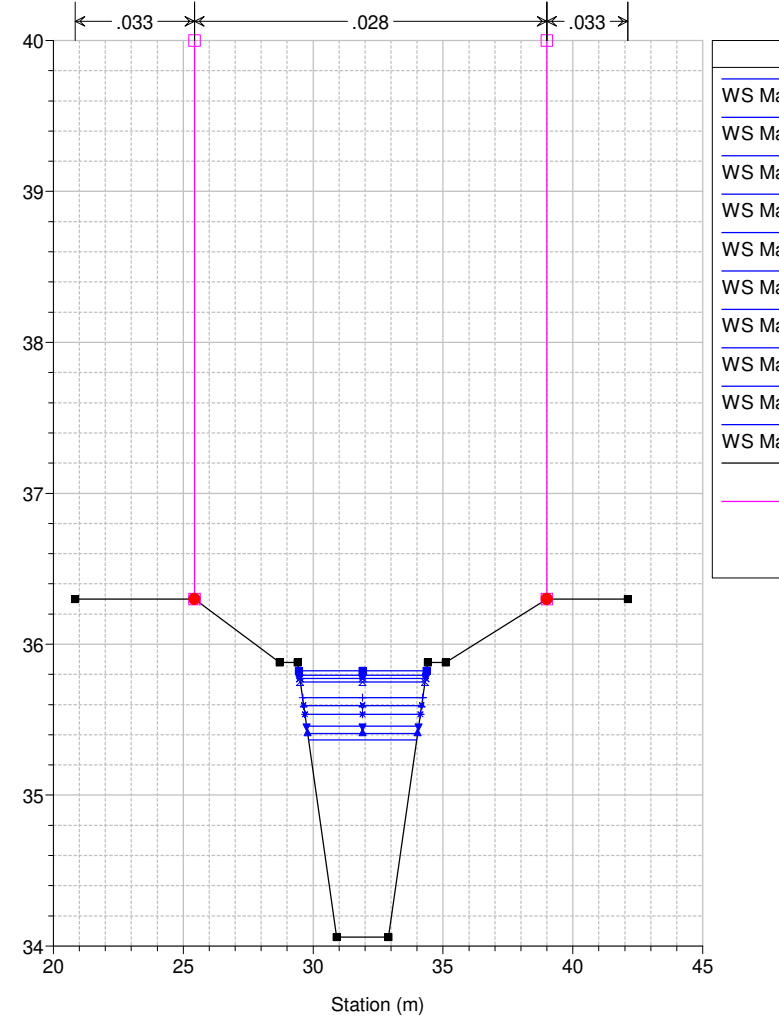

Legend	
WS Max WS - TR030_06_0	■
WS Max WS - TR030_09_0	●
WS Max WS - TR030_03_0	×
WS Max WS - TR030_12_0	+
WS Max WS - TR030_18_0	↑
WS Max WS - TR030_24_0	↓
WS Max WS - TR030_36_0	◆
WS Max WS - TR030_01_5	▼
WS Max WS - TR030_01_0	▲
WS Max WS - TR030_00_5	◆
Ground	■
Levee	□
Bank Sta	●

Studio Scandicci Torrenti Greve-Vingone
River = Fosso Dogaione Reach = Dogaione RS = 29.5 BR

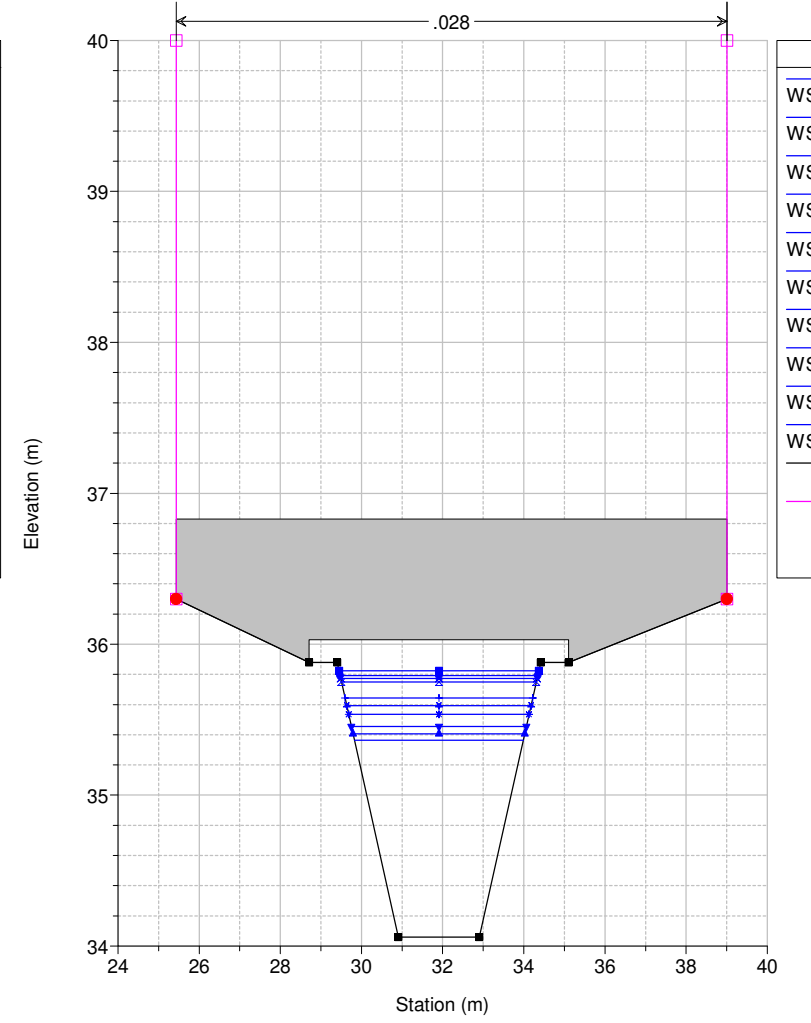

Legend	
WS Max WS - TR030_06_0	■
WS Max WS - TR030_09_0	●
WS Max WS - TR030_03_0	×
WS Max WS - TR030_12_0	+
WS Max WS - TR030_18_0	↑
WS Max WS - TR030_24_0	↓
WS Max WS - TR030_36_0	◆
WS Max WS - TR030_01_5	▼
WS Max WS - TR030_01_0	▲
WS Max WS - TR030_00_5	◆
Ground	■
Levee	□
Bank Sta	●

Studio Scandicci Torrenti Greve-Vingone
River = Fosso Dogaione Reach = Dogaione RS = 29.5 BR

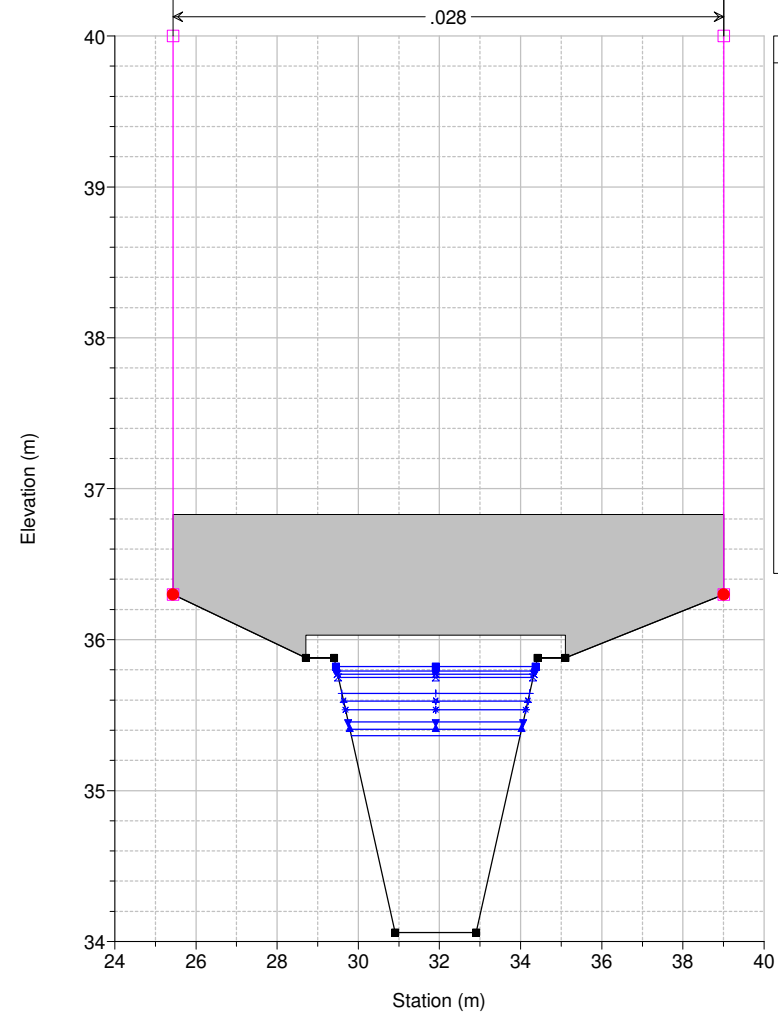

Legend	
WS Max WS - TR030_06_0	■
WS Max WS - TR030_09_0	●
WS Max WS - TR030_03_0	×
WS Max WS - TR030_12_0	+
WS Max WS - TR030_18_0	↑
WS Max WS - TR030_24_0	↓
WS Max WS - TR030_36_0	◆
WS Max WS - TR030_01_5	▼
WS Max WS - TR030_01_0	▲
WS Max WS - TR030_00_5	◆
Ground	■
Levee	□
Bank Sta	●

Studio Scandicci Torrenti Greve-Vingone
River = Fosso Dogaione Reach = Dogaione RS = 29 DG1014_C

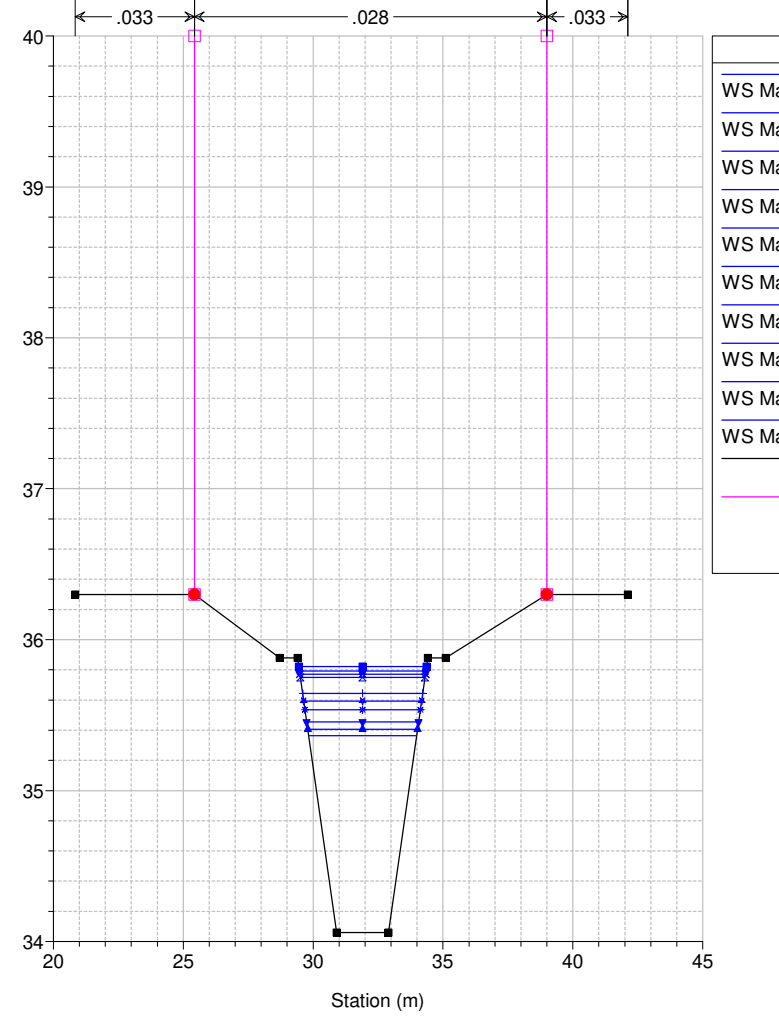

Legend	
WS Max WS - TR030_06_0	■
WS Max WS - TR030_09_0	●
WS Max WS - TR030_03_0	×
WS Max WS - TR030_12_0	+
WS Max WS - TR030_18_0	↑
WS Max WS - TR030_24_0	↓
WS Max WS - TR030_36_0	◆
WS Max WS - TR030_01_5	▼
WS Max WS - TR030_01_0	▲
WS Max WS - TR030_00_5	◆
Ground	■
Levee	□
Bank Sta	●

Studio Scandicci Torrenti Greve-Vingone
River = Fosso Dogaione Reach = Dogaione RS = 28 DG1014_D

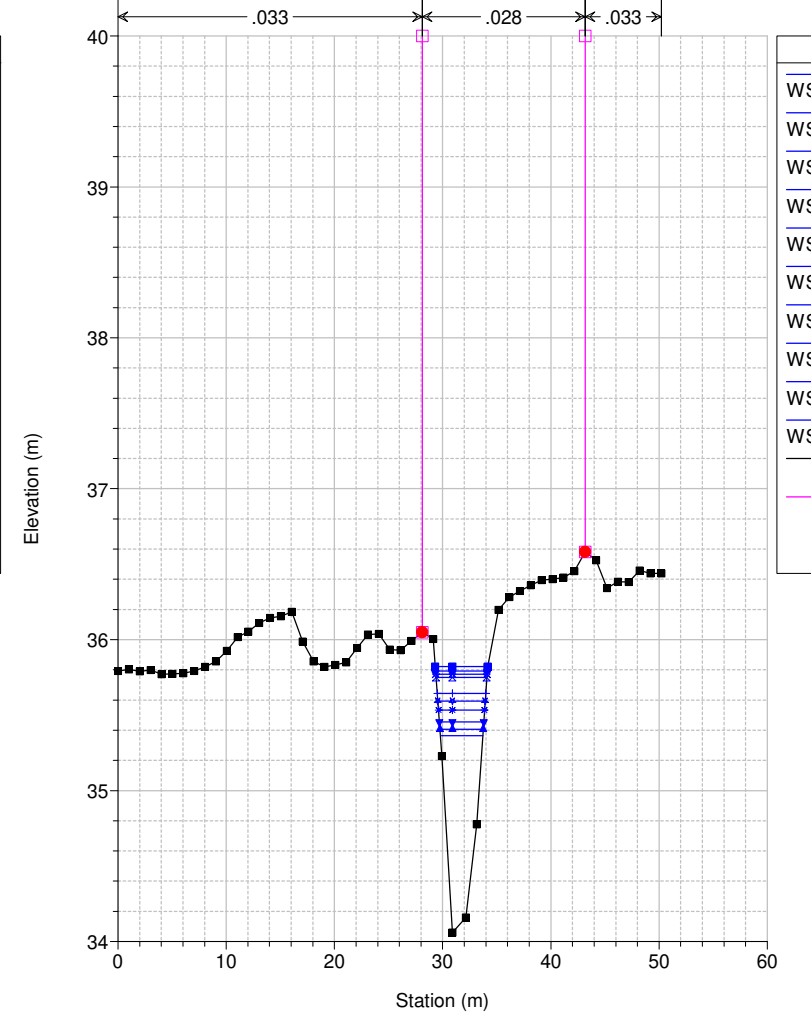

Legend	
WS Max WS - TR030_06_0	■
WS Max WS - TR030_09_0	●
WS Max WS - TR030_03_0	×
WS Max WS - TR030_12_0	+
WS Max WS - TR030_18_0	↑
WS Max WS - TR030_24_0	↓
WS Max WS - TR030_36_0	◆
WS Max WS - TR030_01_5	▼
WS Max WS - TR030_01_0	▲
WS Max WS - TR030_00_5	◆
Ground	■
Levee	□
Bank Sta	●

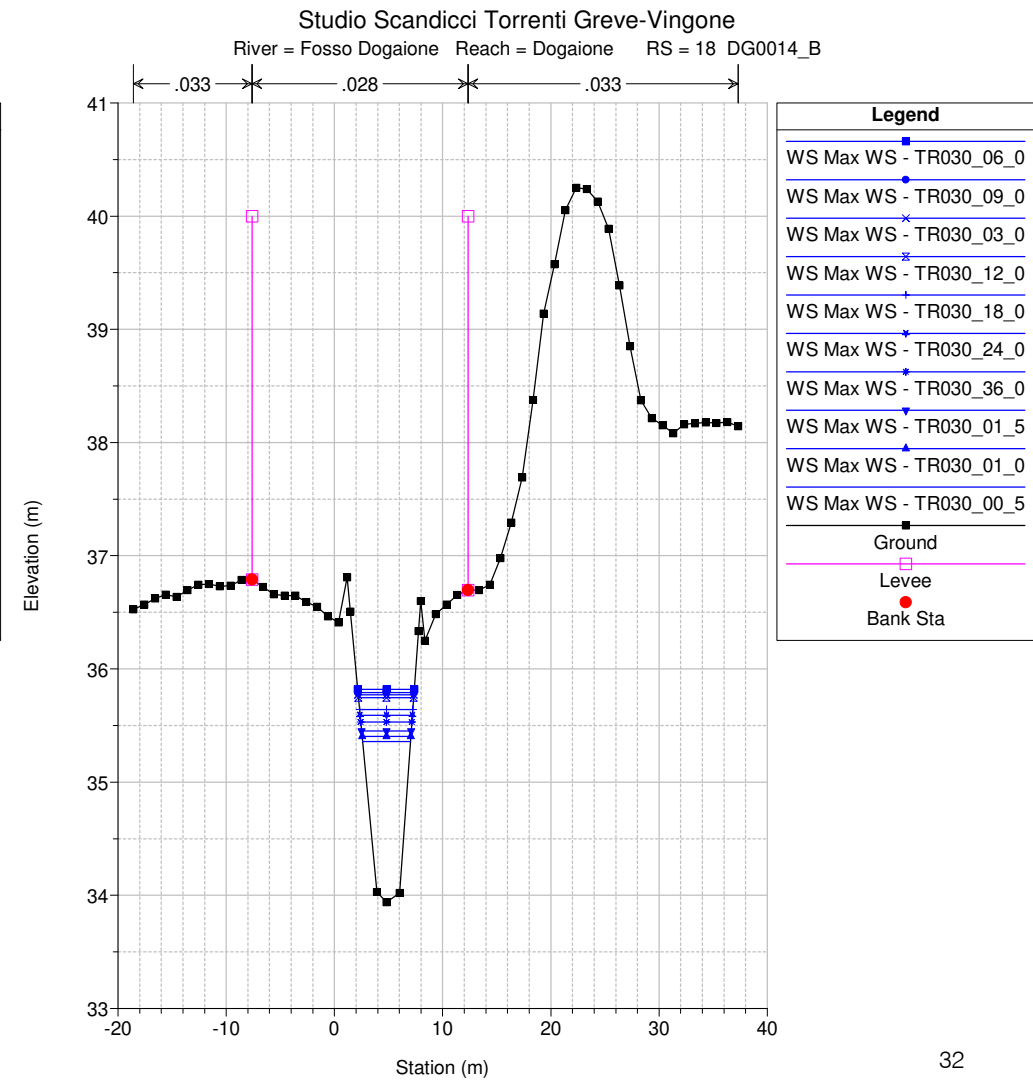
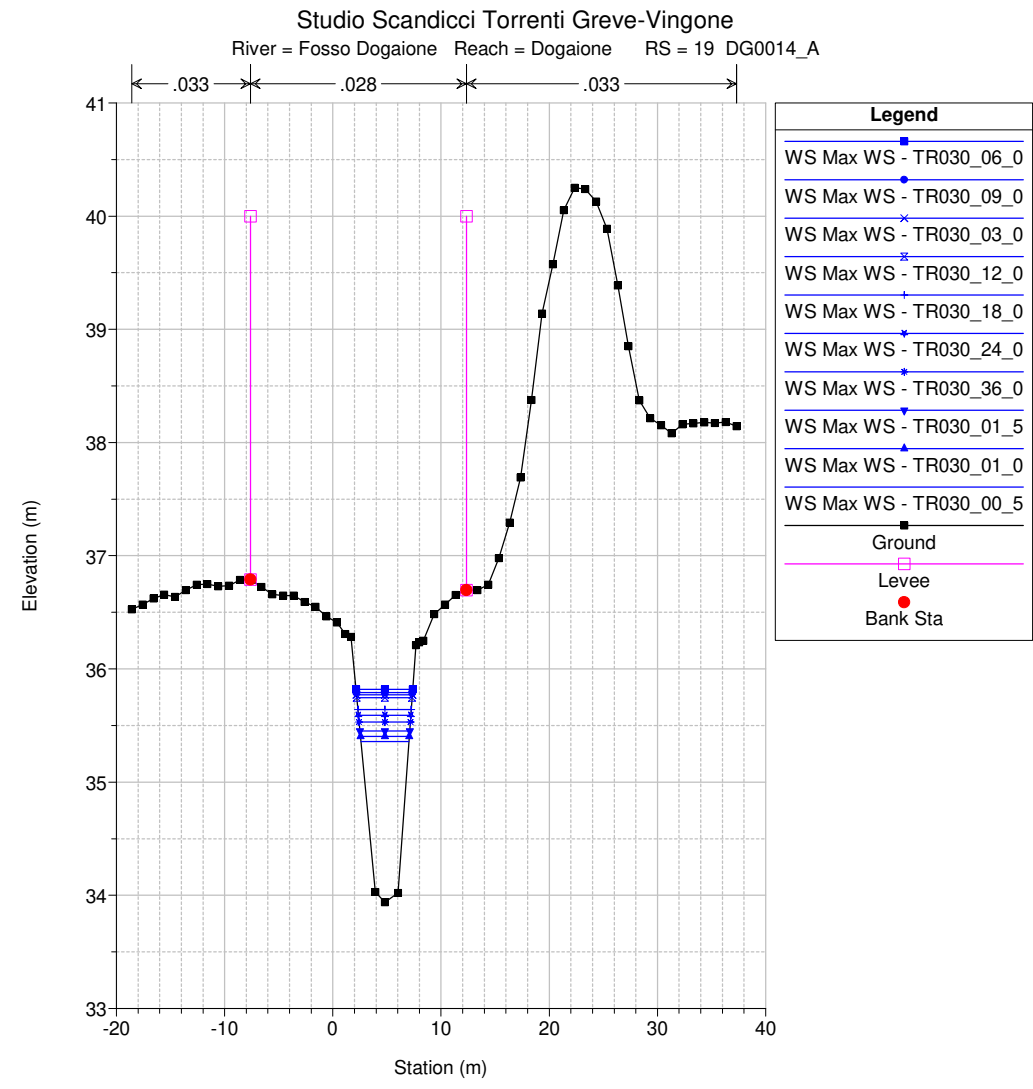
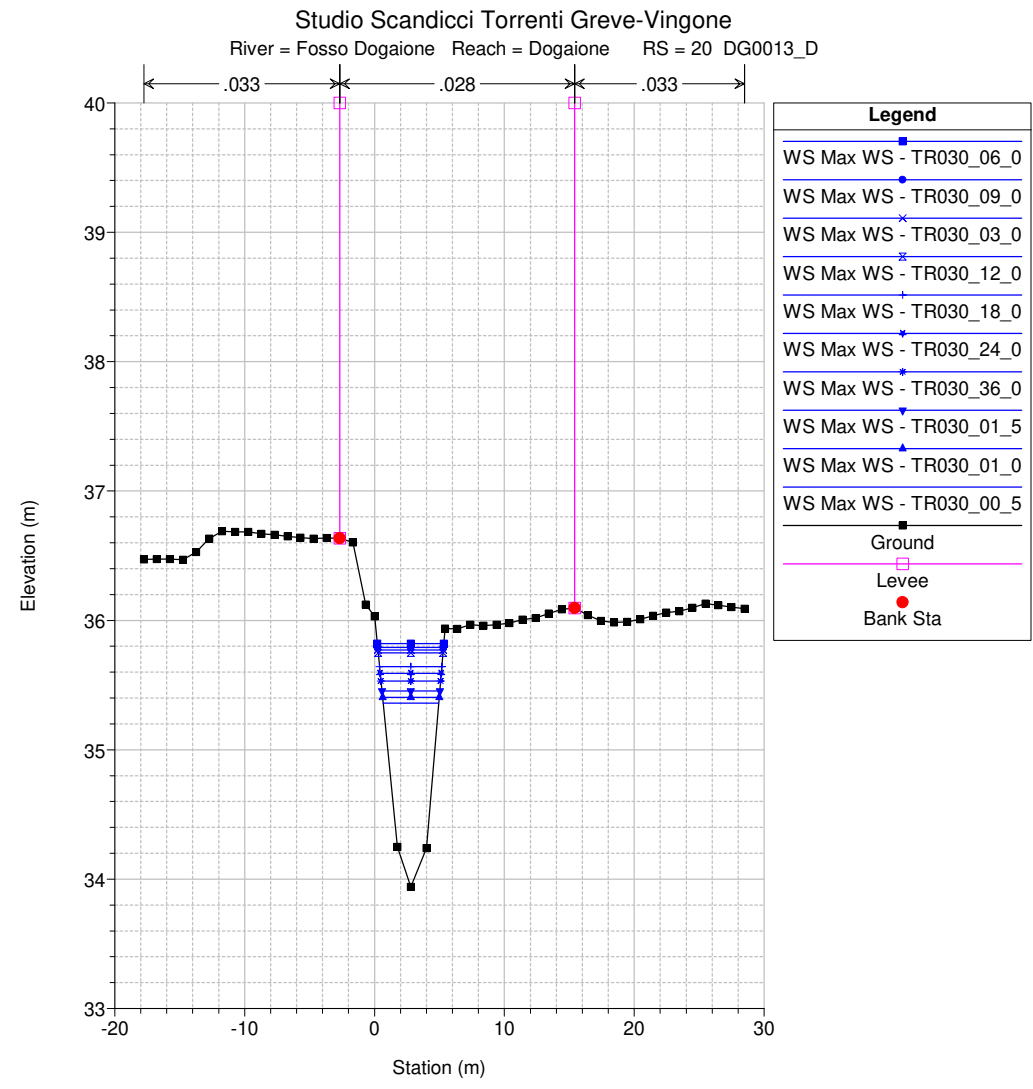
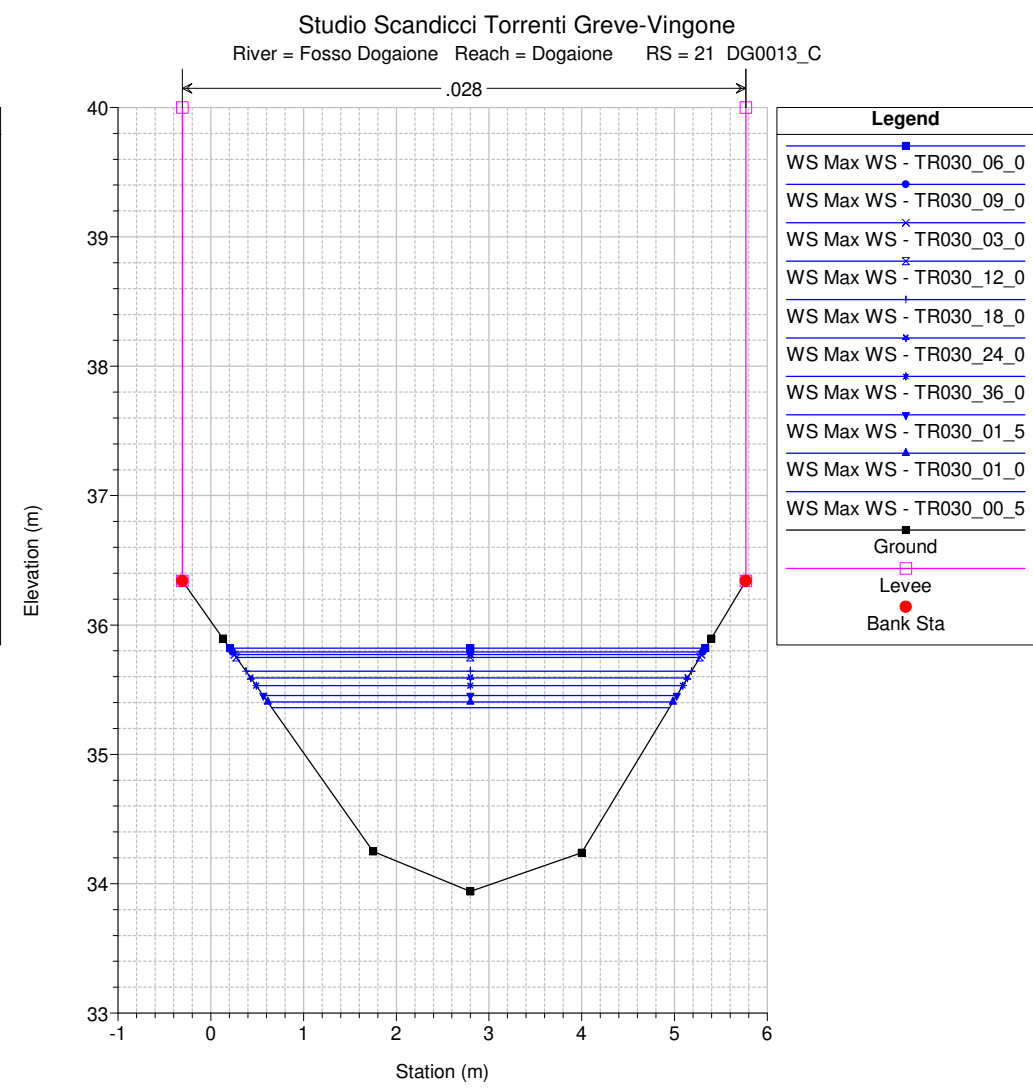
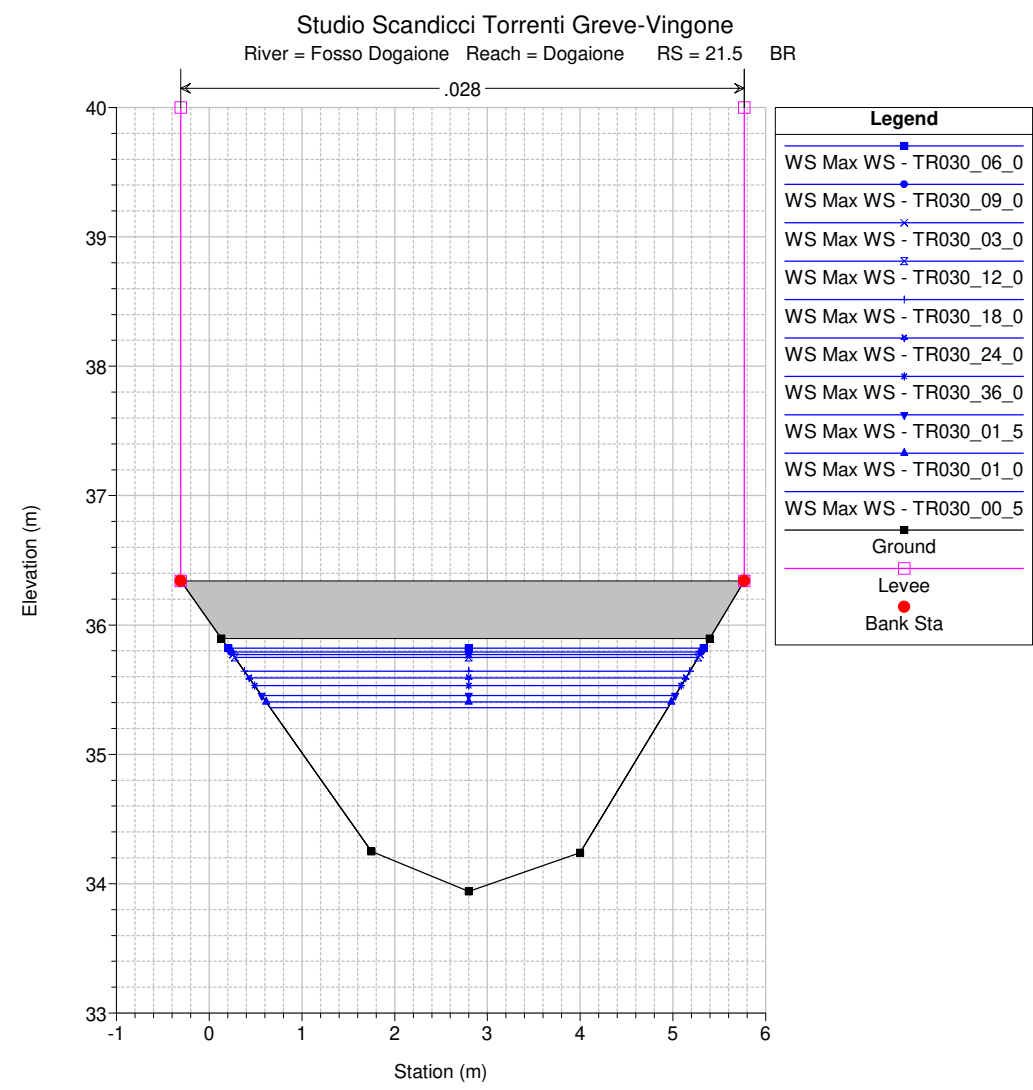
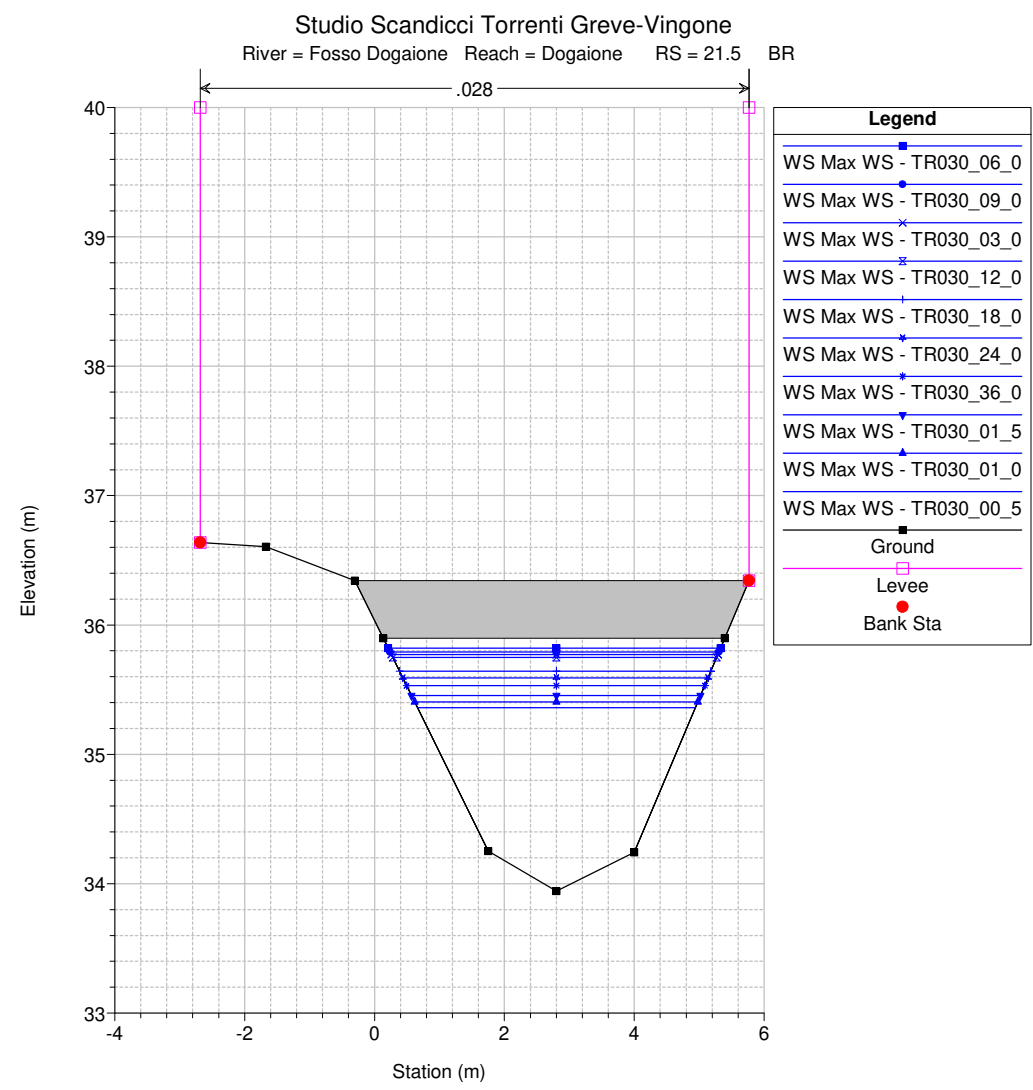

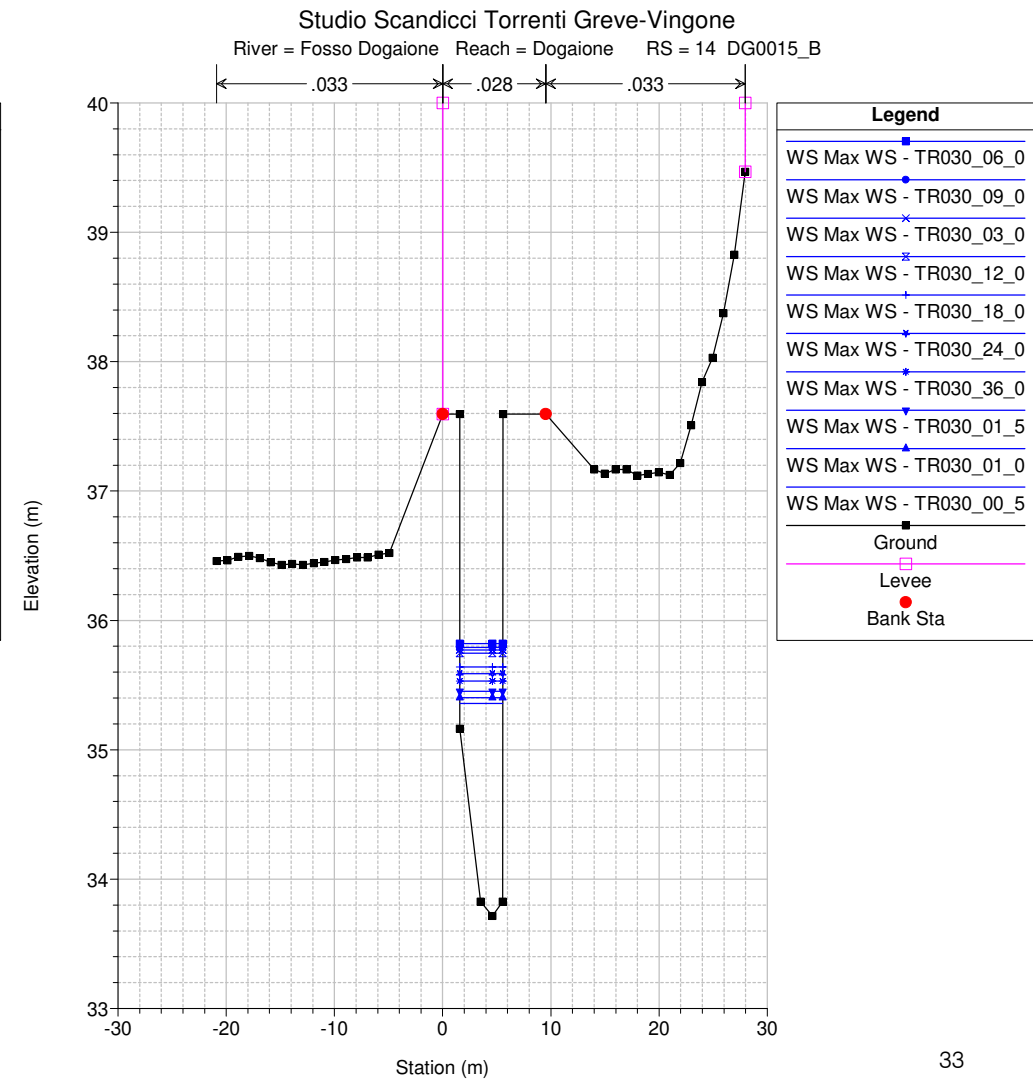
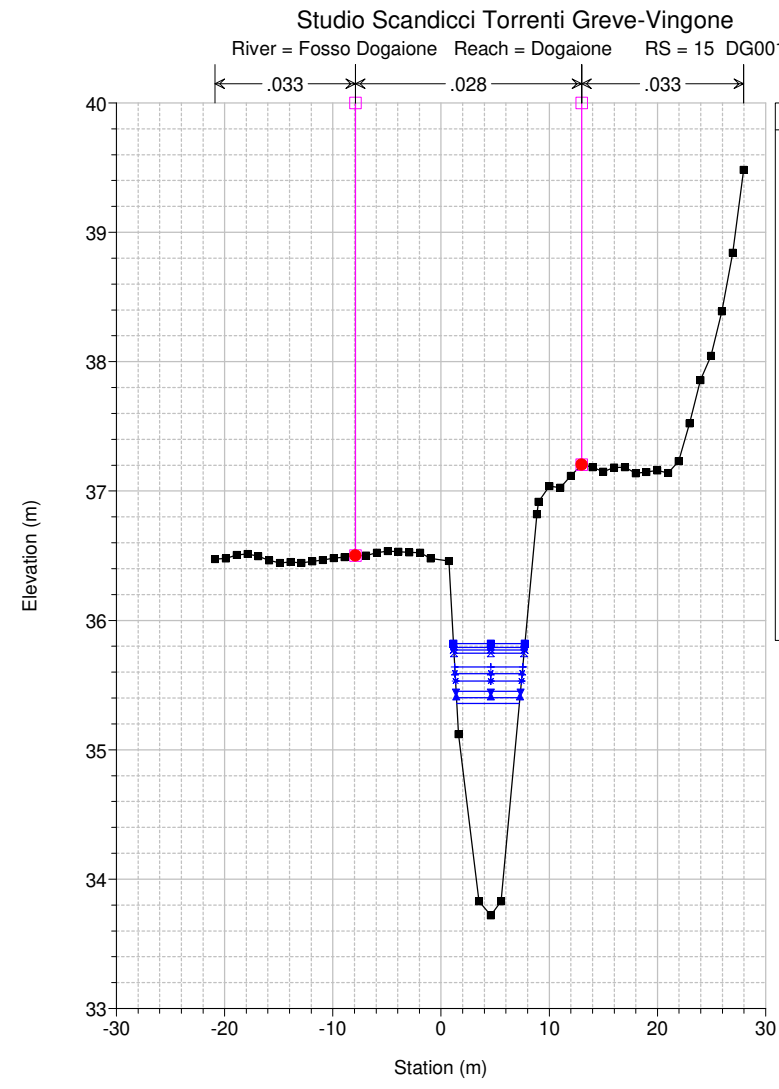
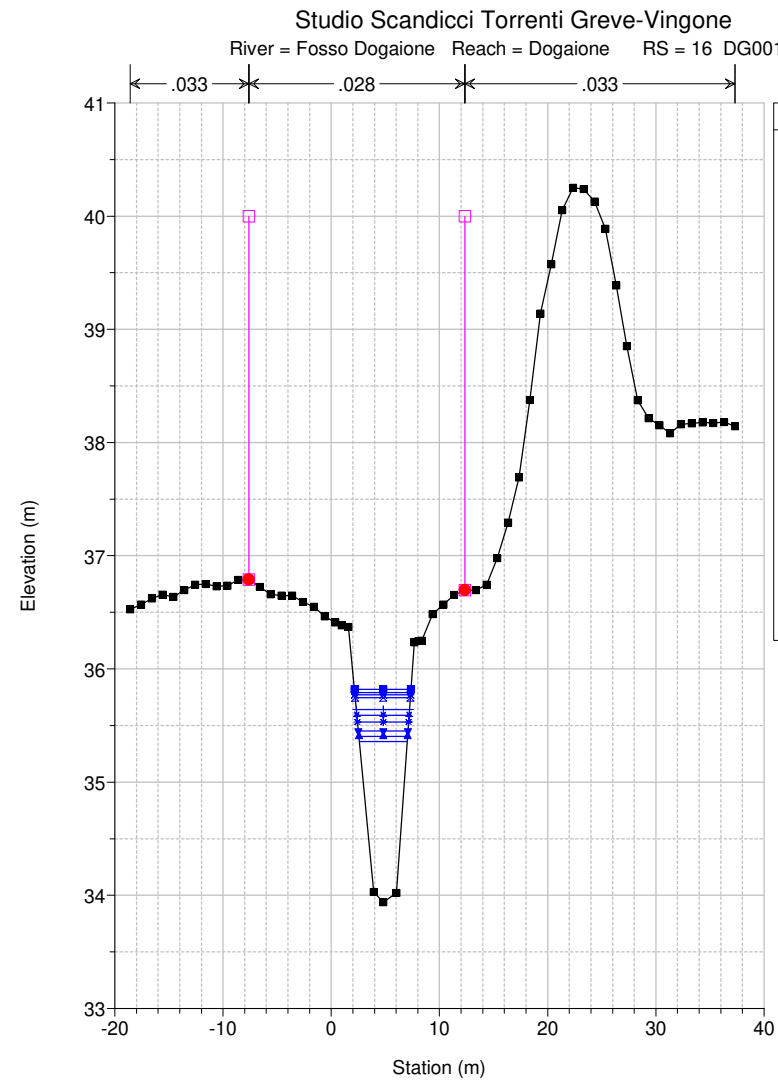
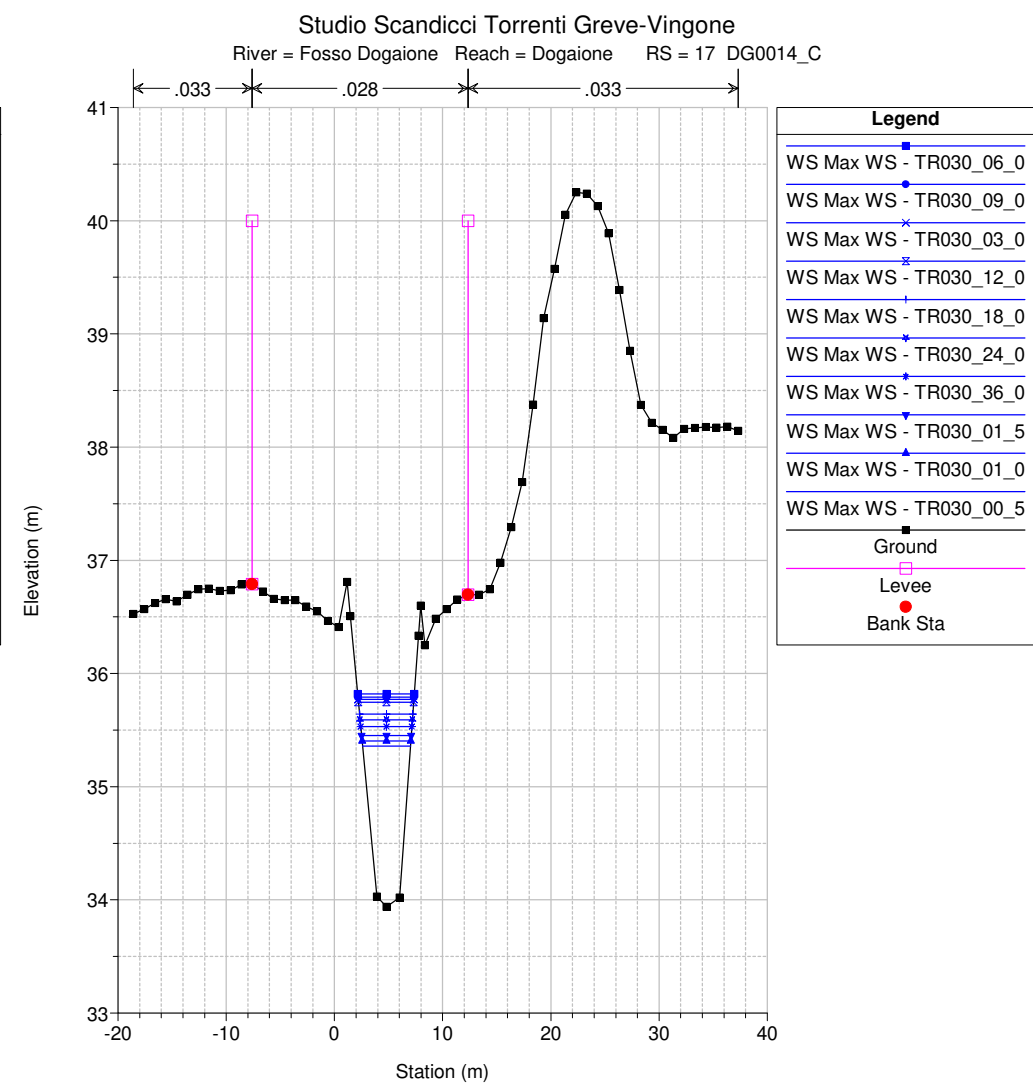
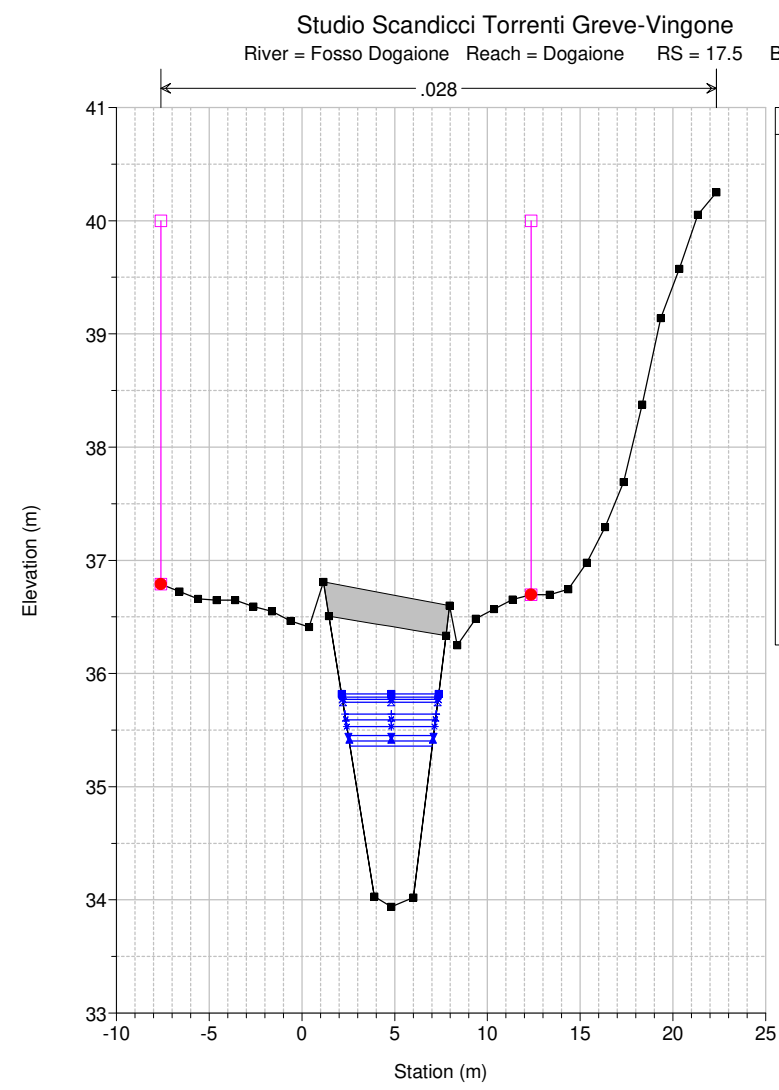
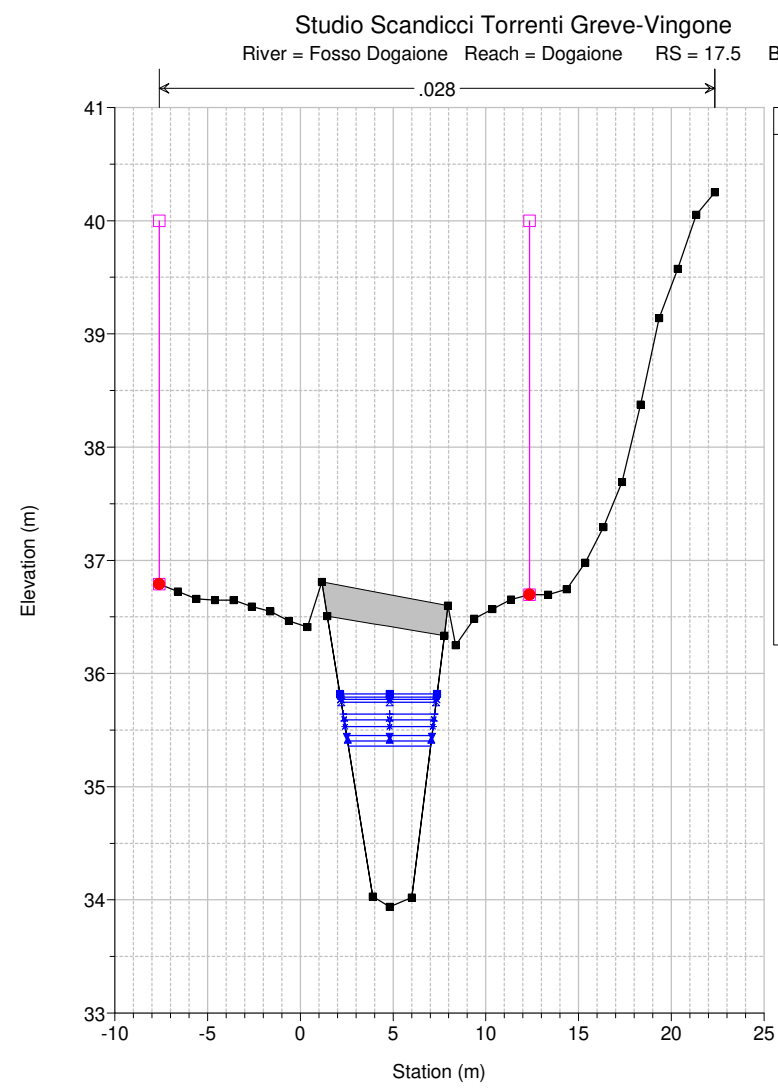

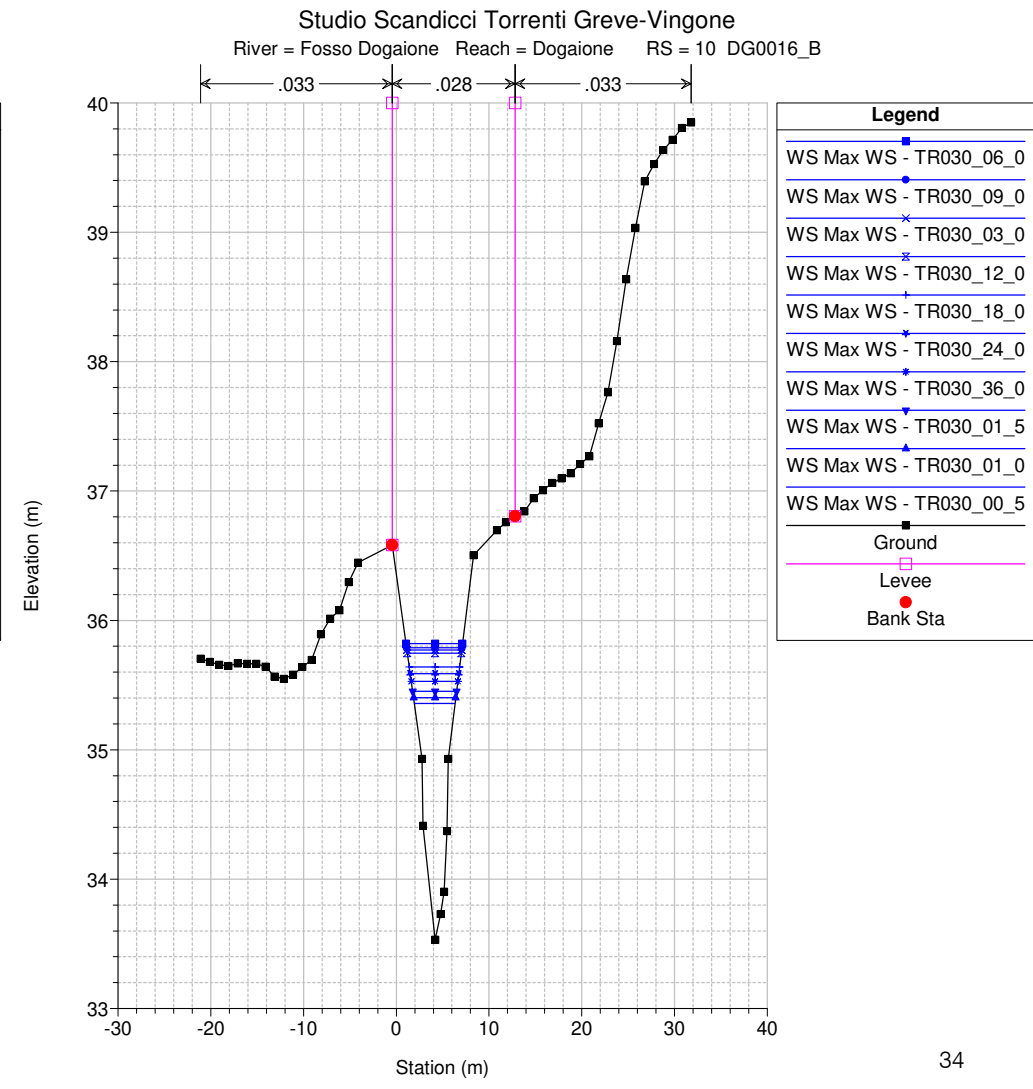
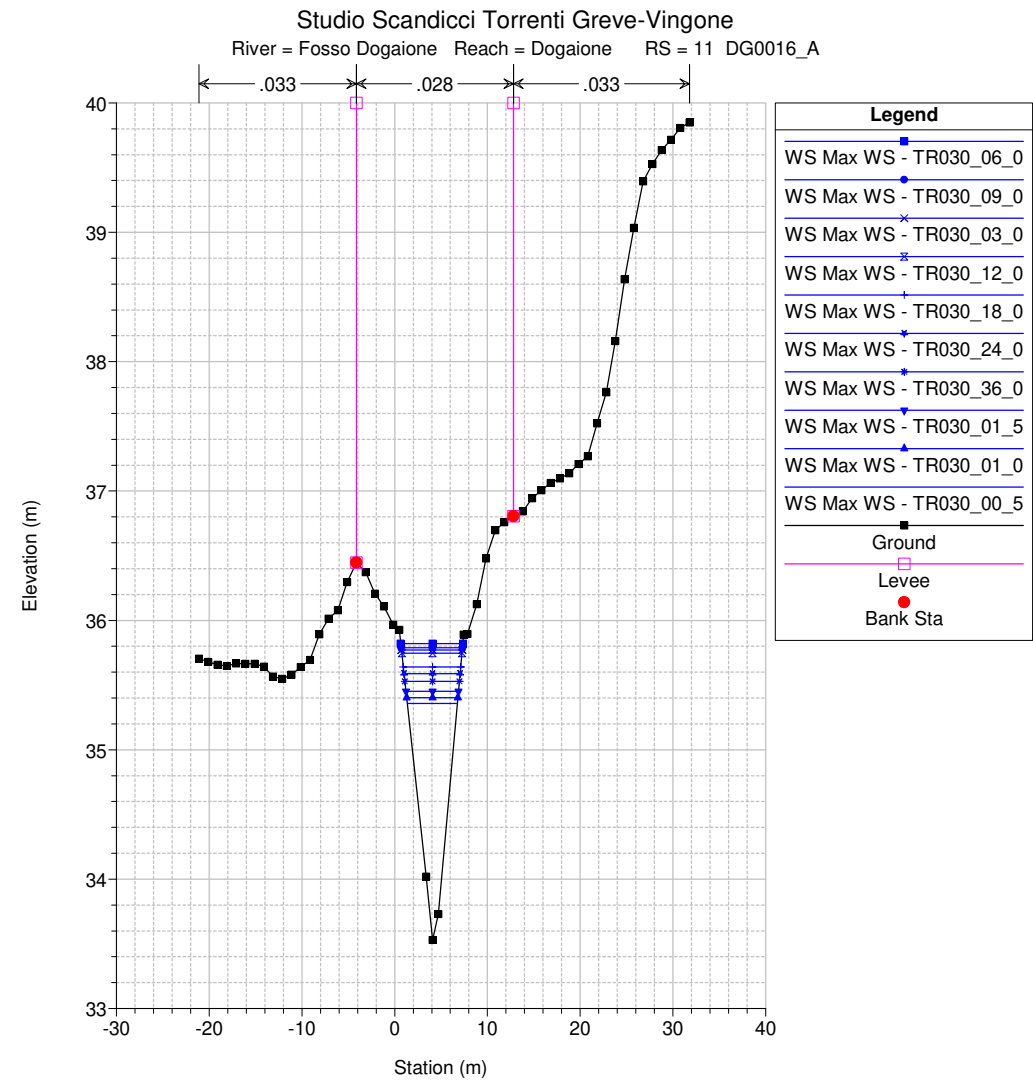
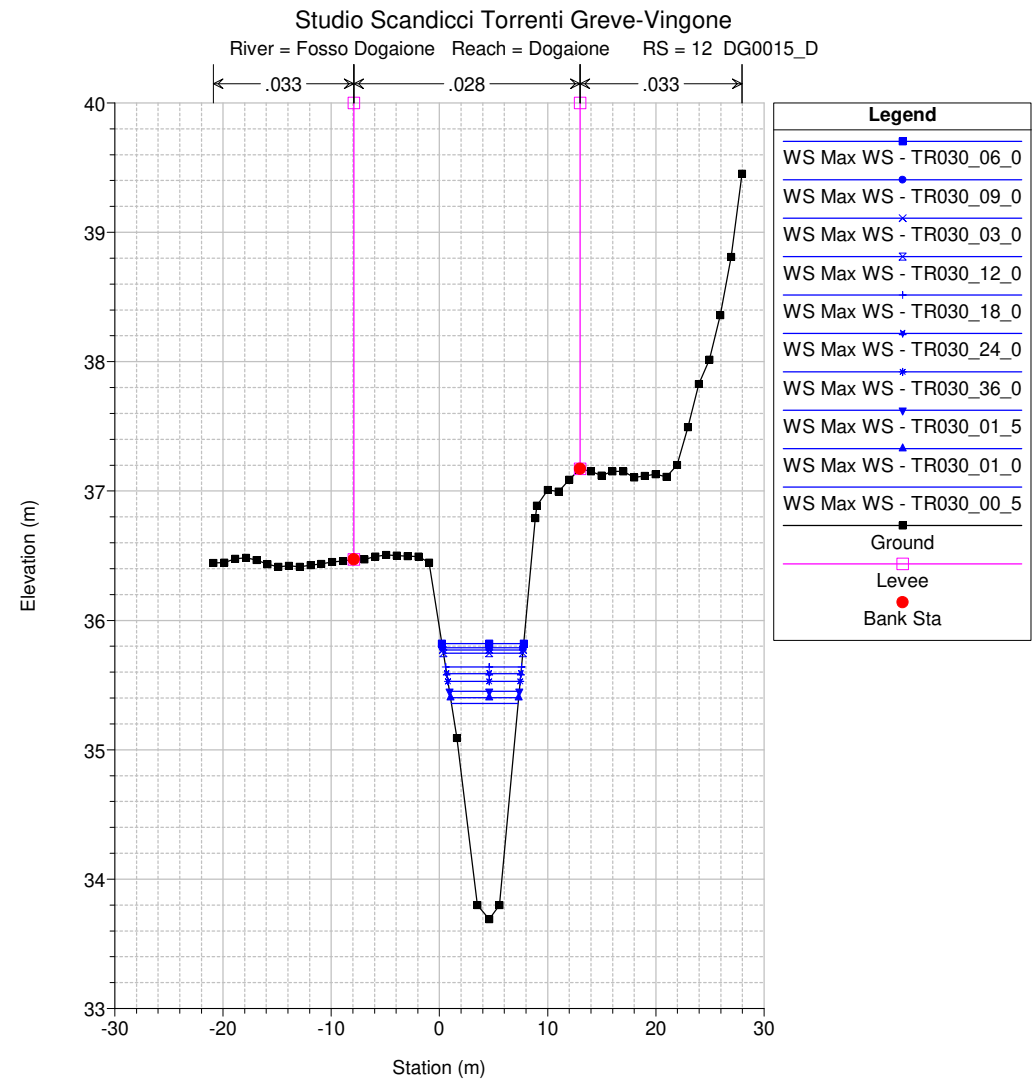
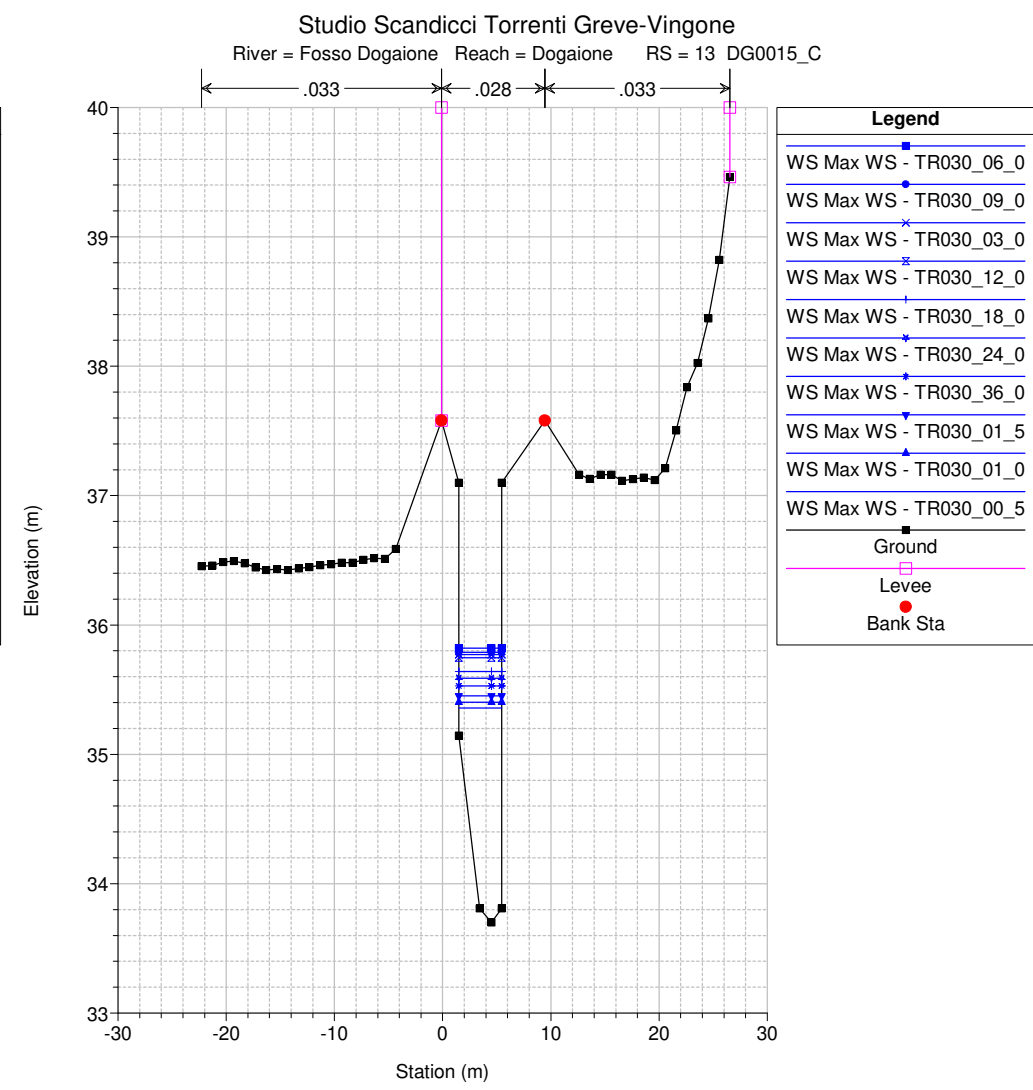
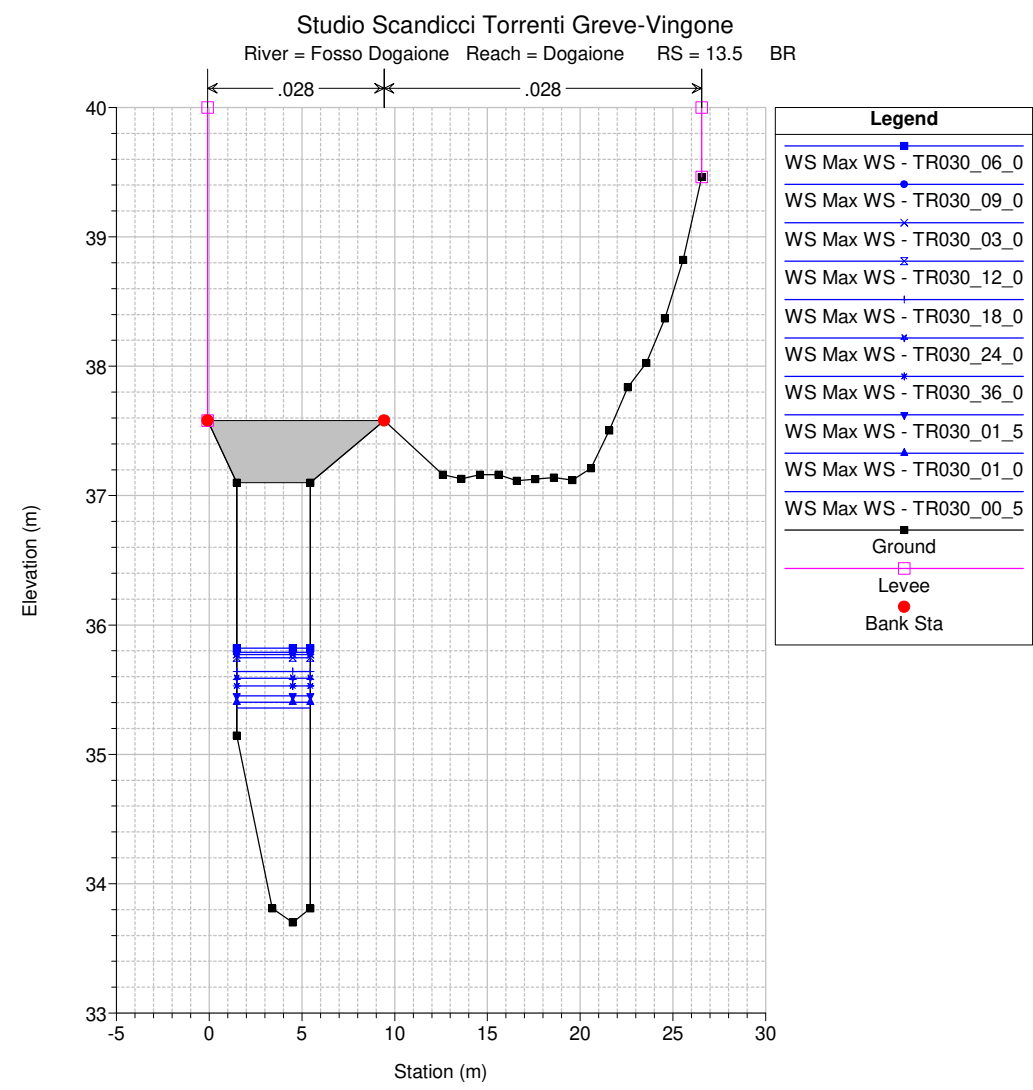
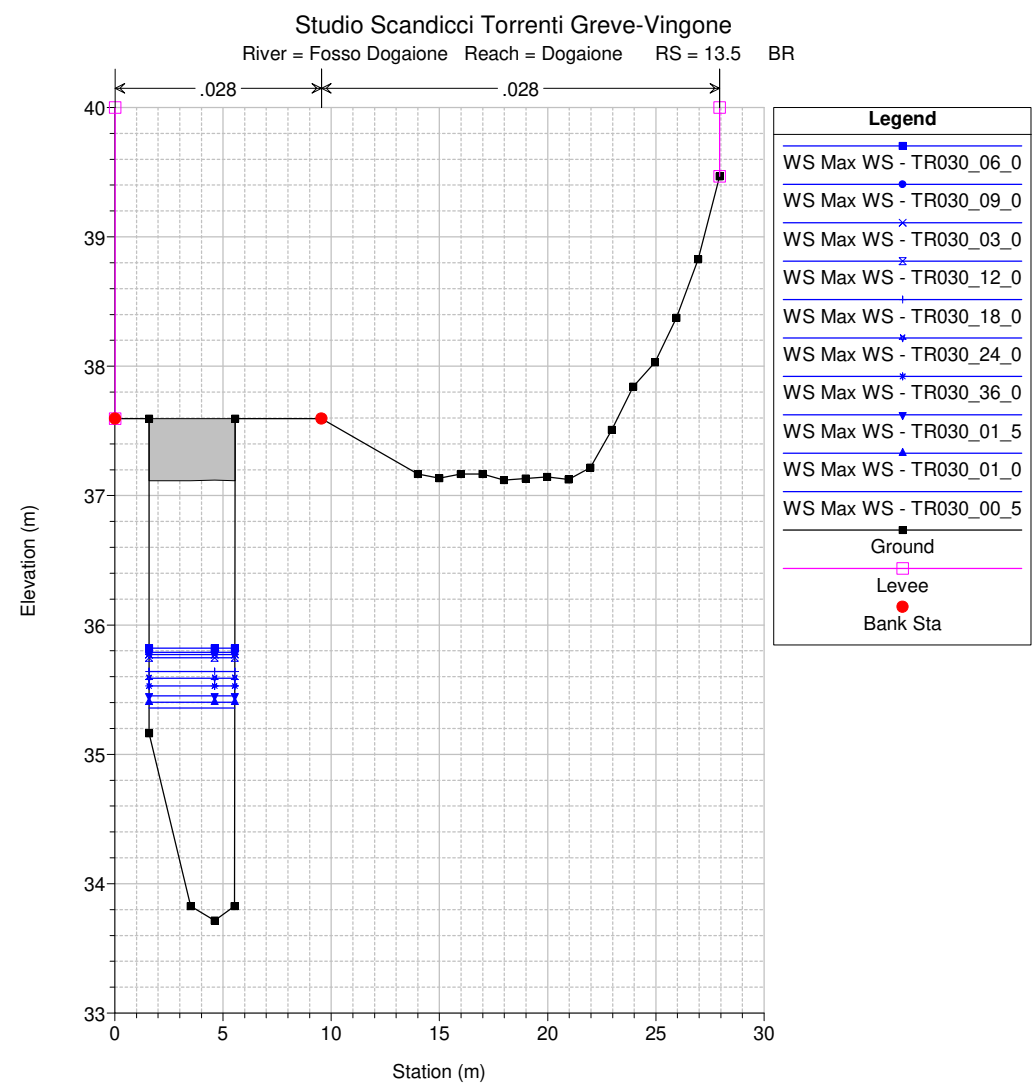

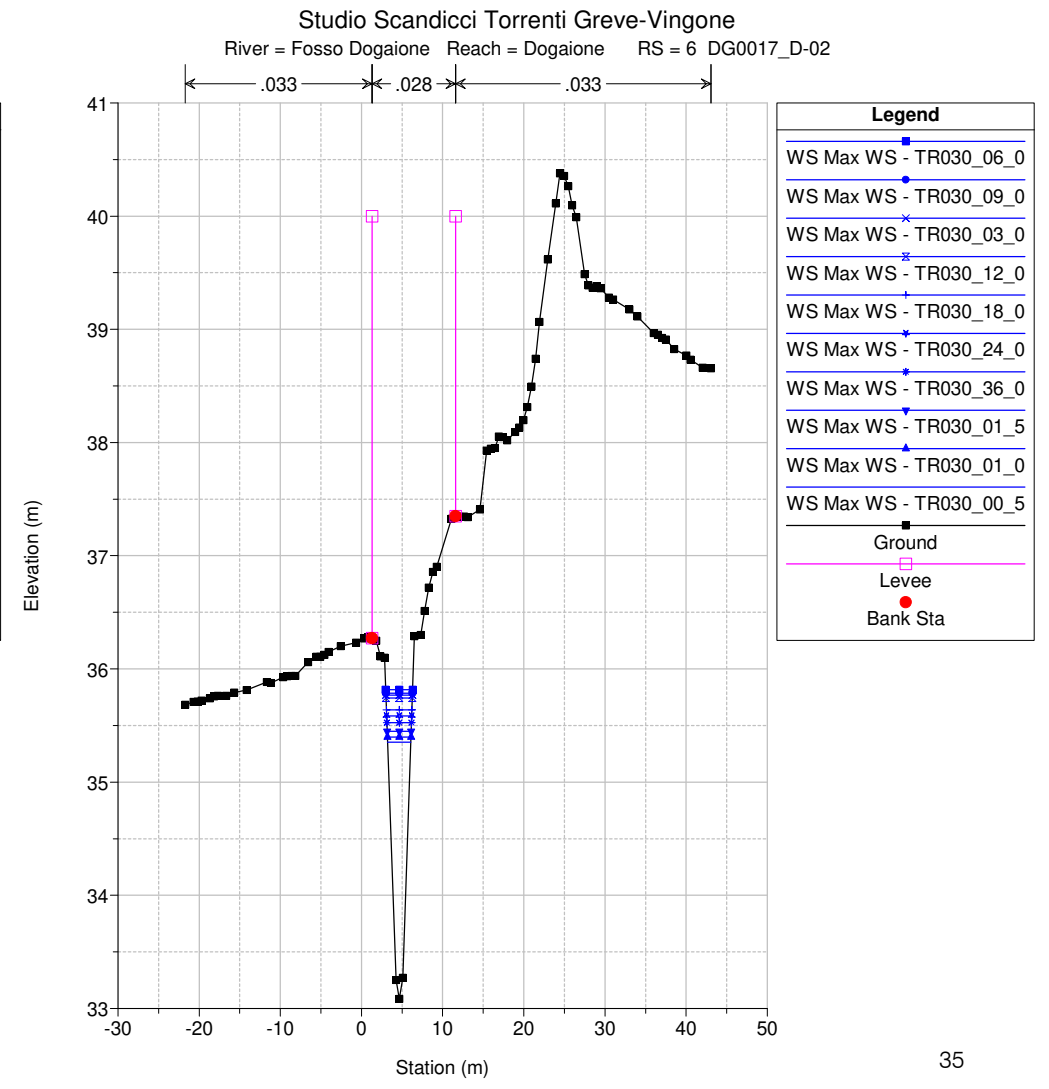
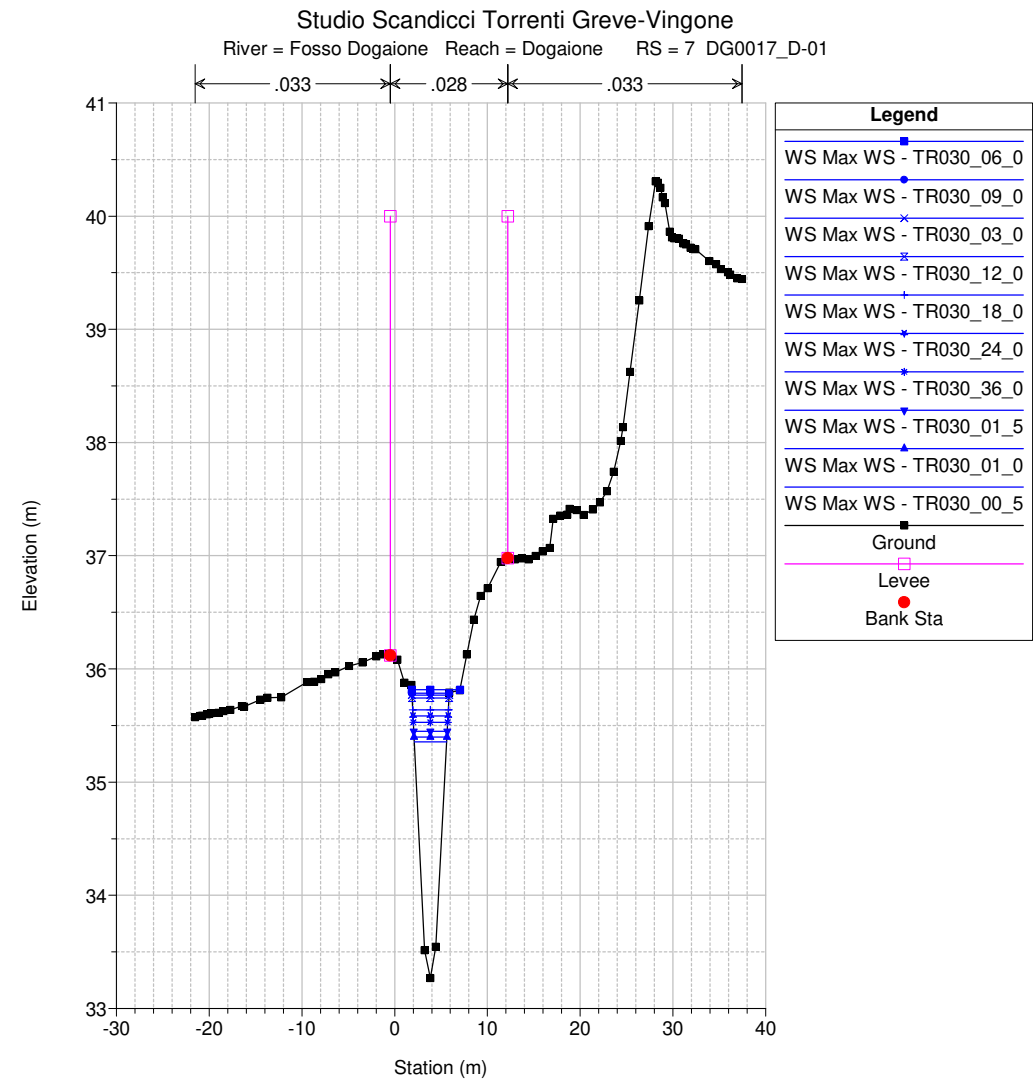
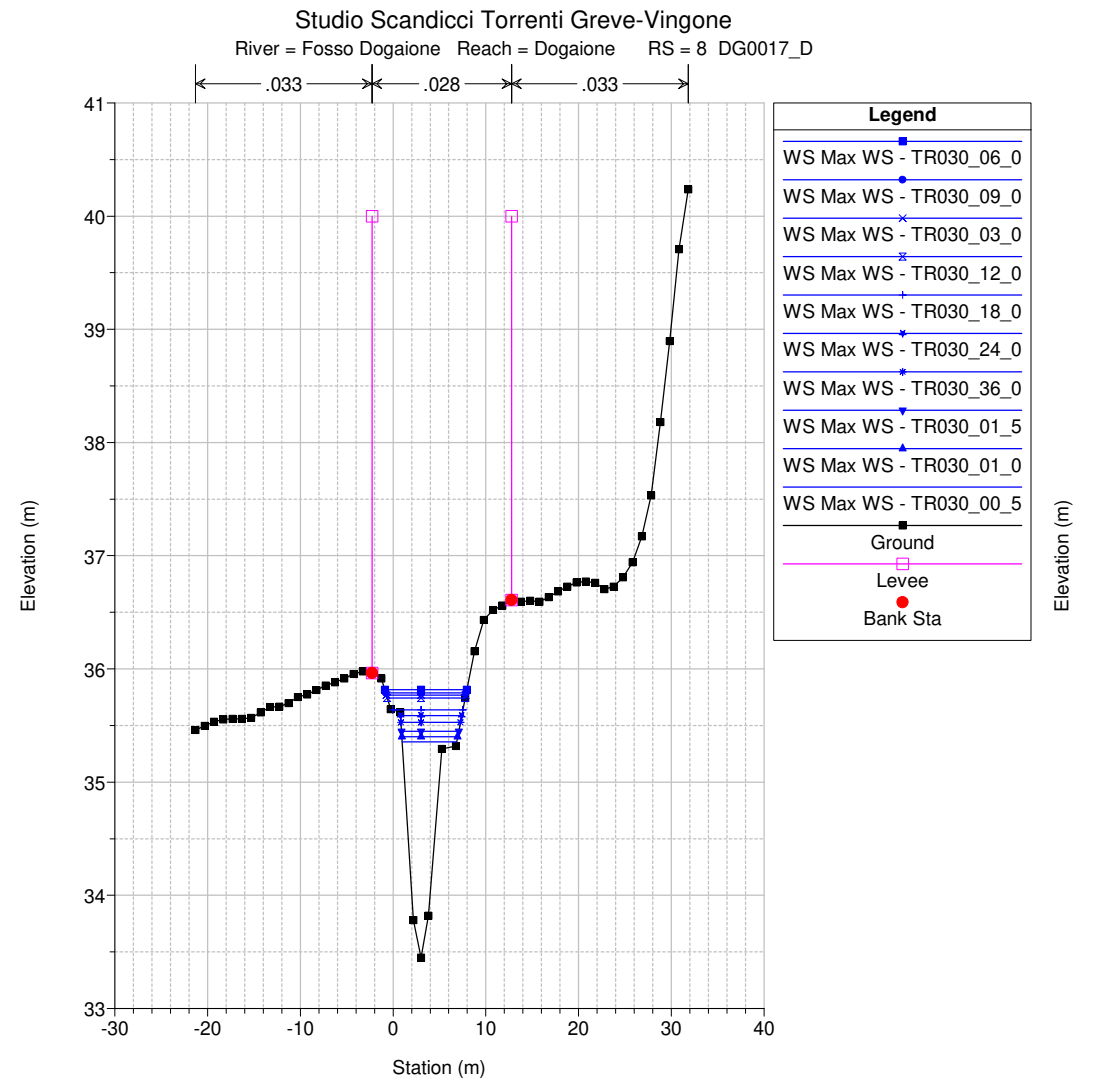
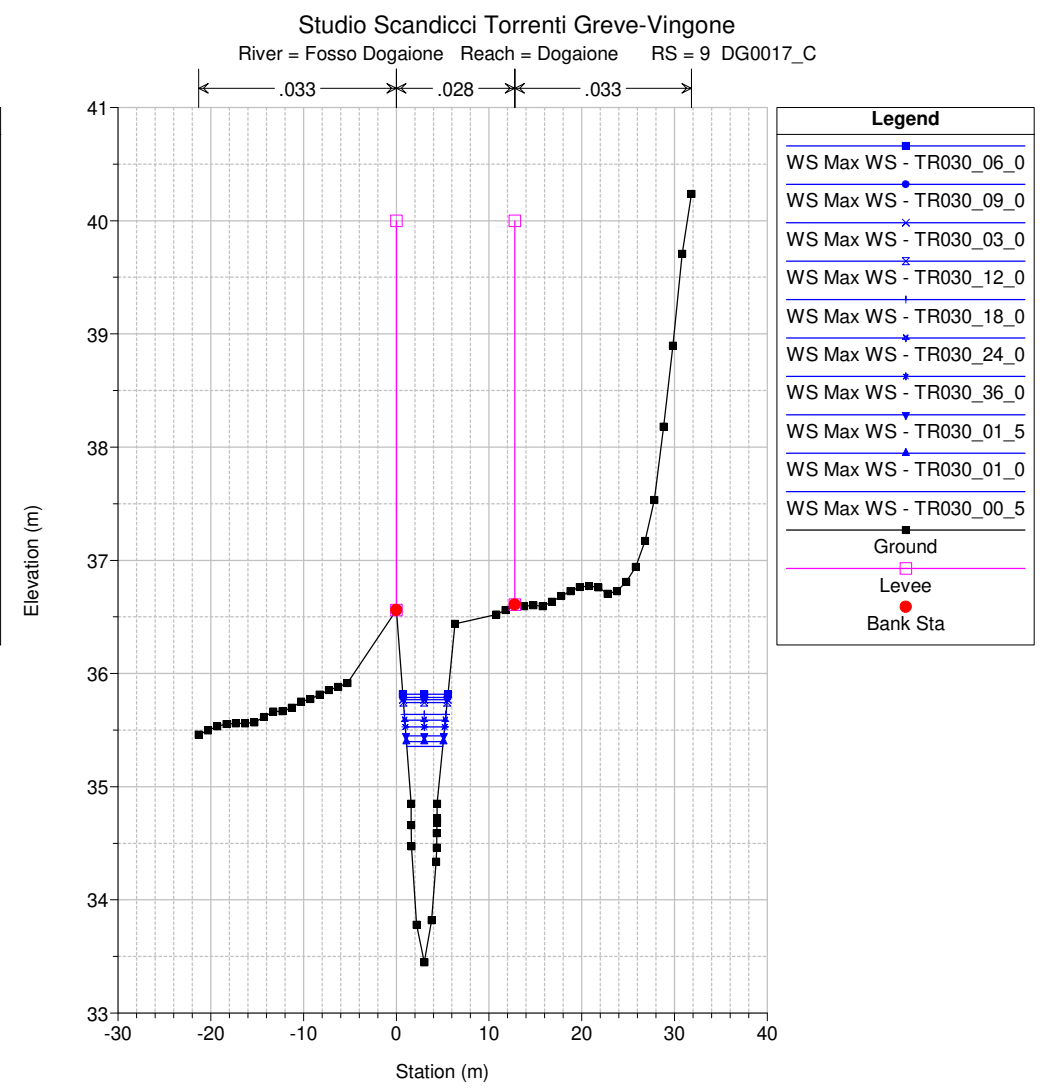
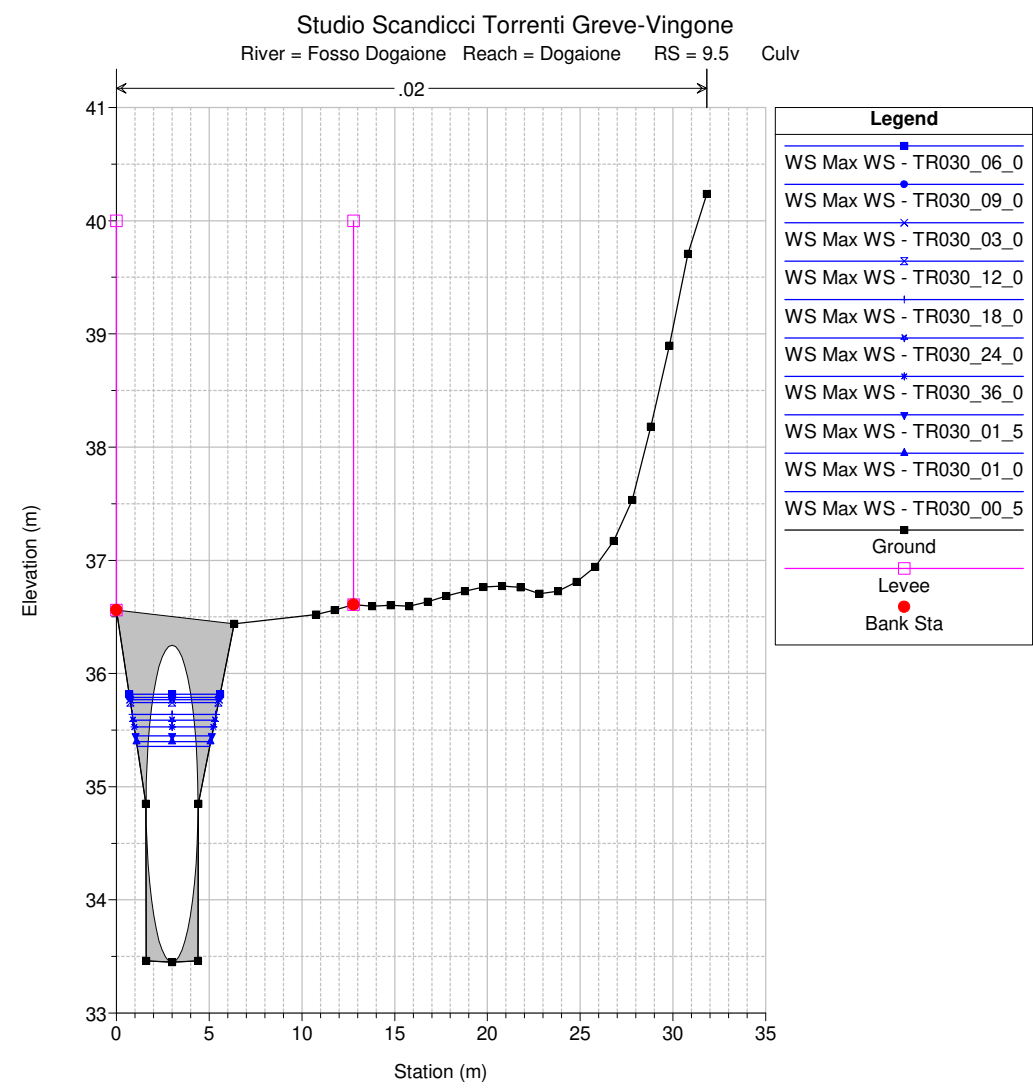
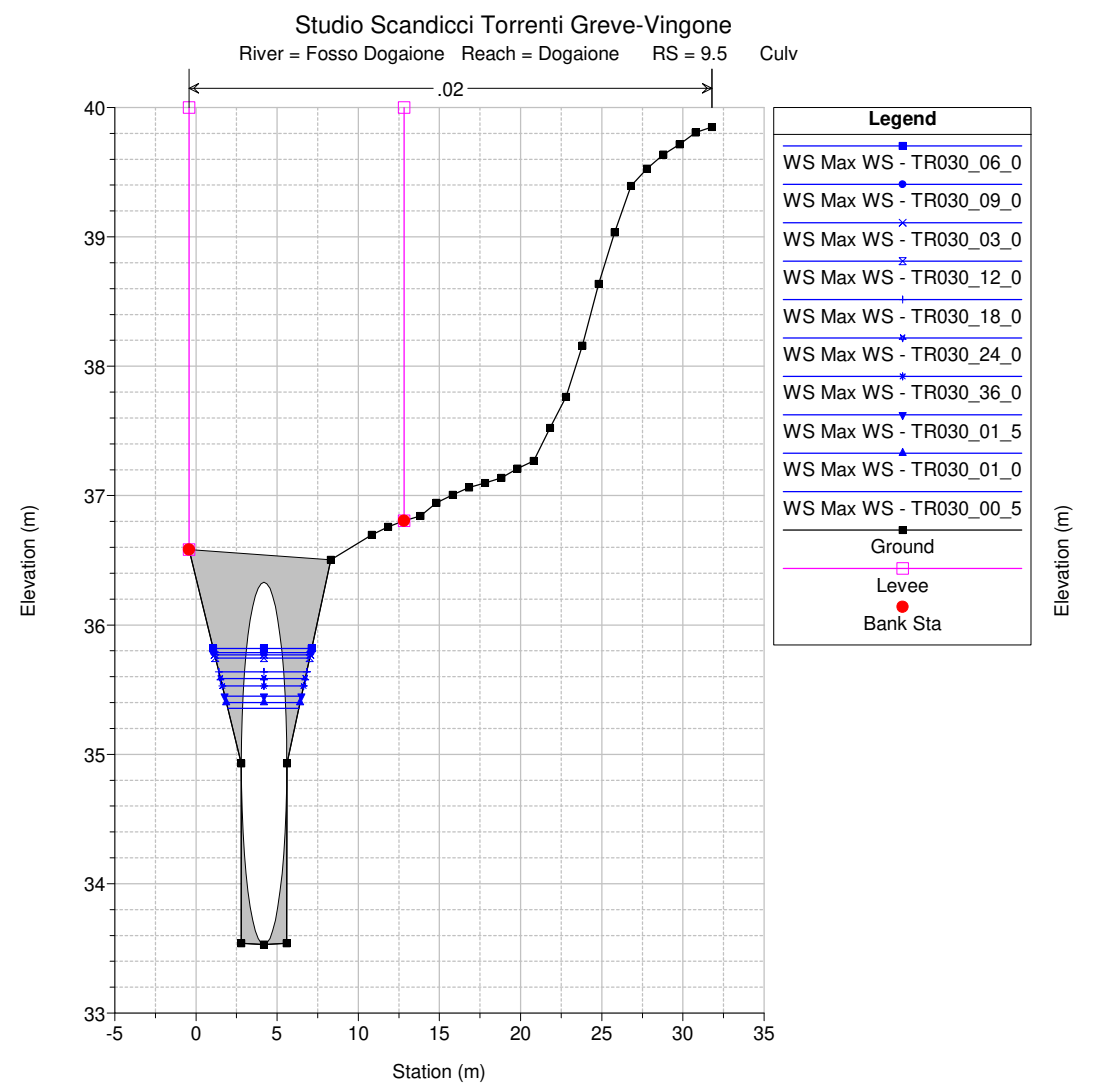

Studio Scandicci Torrenti Greve-Vingone
River = Fosso Dogaione Reach = Dogaione RS = 5 DG0017_D-03

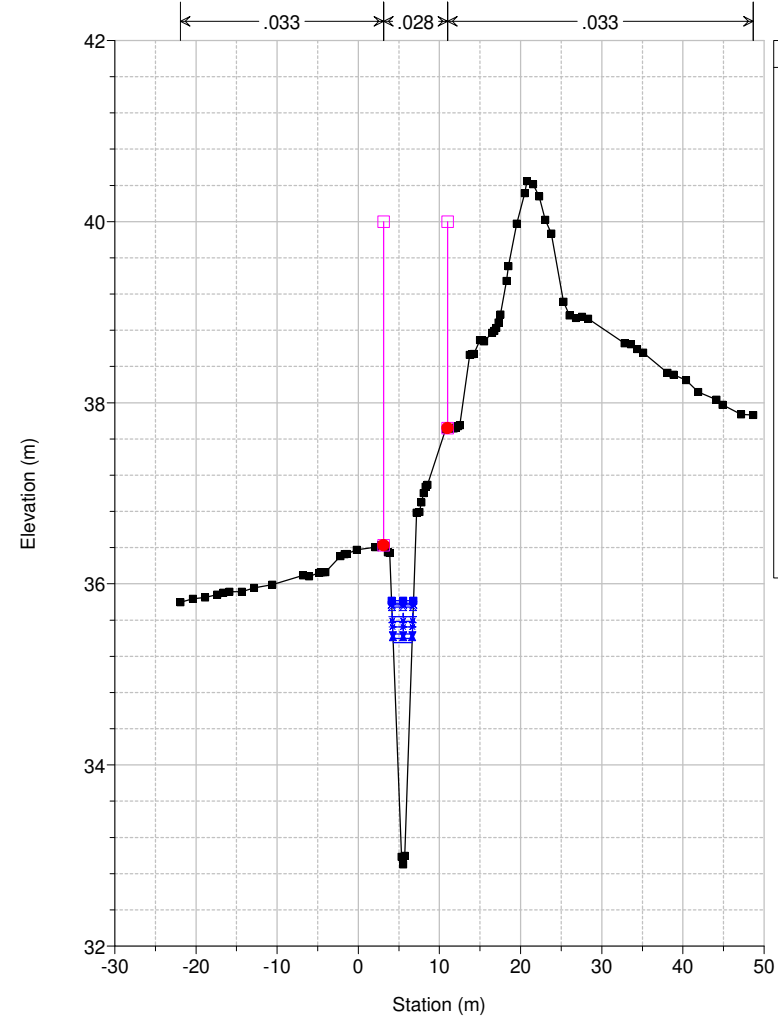

Legend	
WS Max WS - TR030_06_0	■
WS Max WS - TR030_09_0	●
WS Max WS - TR030_03_0	×
WS Max WS - TR030_12_0	+
WS Max WS - TR030_18_0	▲
WS Max WS - TR030_24_0	▼
WS Max WS - TR030_36_0	◆
WS Max WS - TR030_01_5	▲
WS Max WS - TR030_01_0	▲
WS Max WS - TR030_00_5	▲
Ground	■
Levee	□
Bank Sta	●

Studio Scandicci Torrenti Greve-Vingone
River = Fosso Dogaione Reach = Dogaione RS = 4 DG0018_A

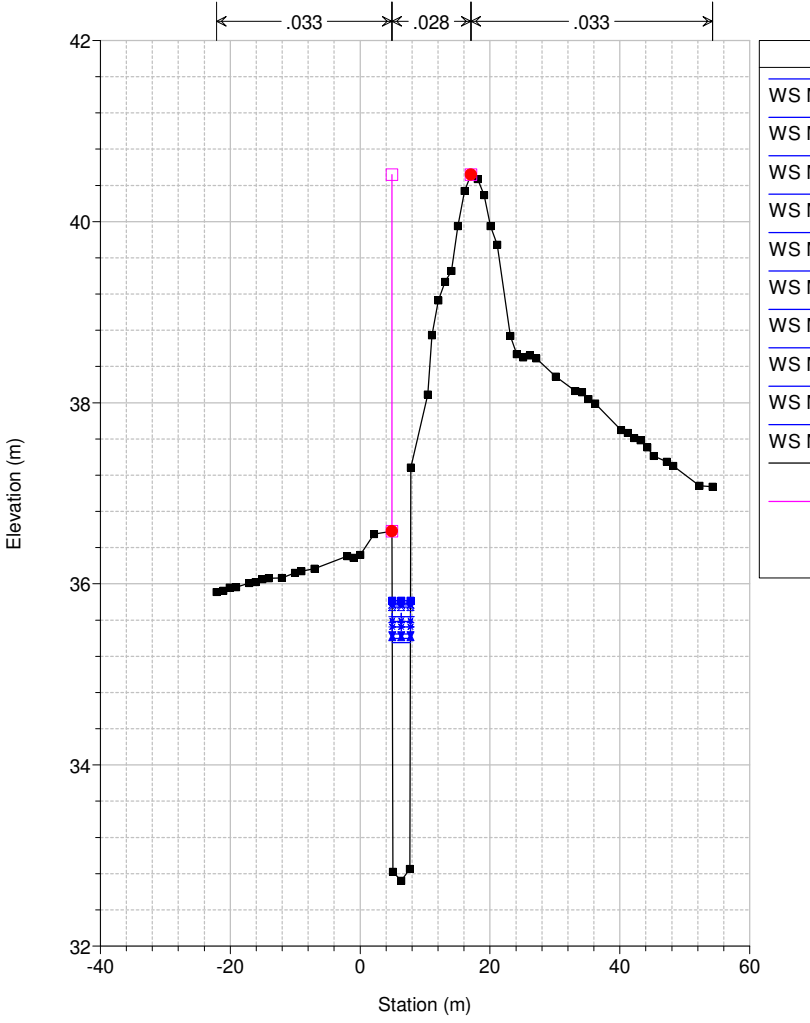

Legend	
WS Max WS - TR030_06_0	■
WS Max WS - TR030_09_0	●
WS Max WS - TR030_03_0	×
WS Max WS - TR030_12_0	+
WS Max WS - TR030_18_0	▲
WS Max WS - TR030_24_0	▼
WS Max WS - TR030_36_0	◆
WS Max WS - TR030_01_5	▲
WS Max WS - TR030_01_0	▲
WS Max WS - TR030_00_5	▲
Ground	■
Levee	□
Bank Sta	●

Studio Scandicci Torrenti Greve-Vingone
River = Fosso Dogaione Reach = Dogaione RS = 3 DG0018_B

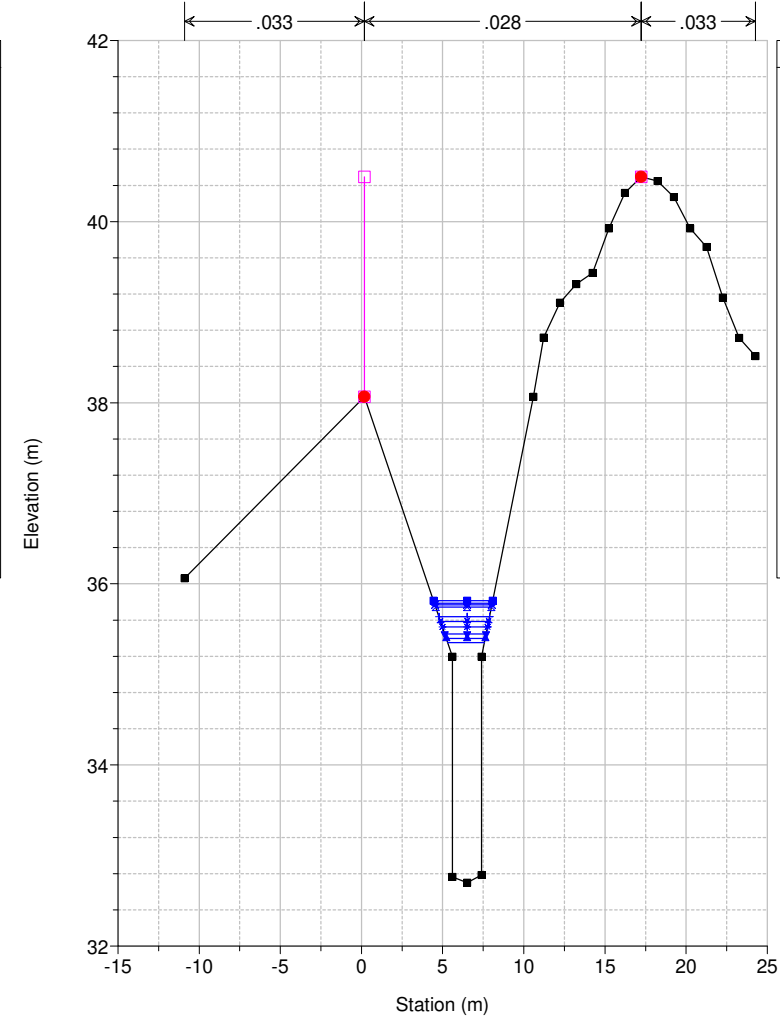

Legend	
WS Max WS - TR030_06_0	■
WS Max WS - TR030_09_0	●
WS Max WS - TR030_03_0	×
WS Max WS - TR030_12_0	+
WS Max WS - TR030_18_0	▲
WS Max WS - TR030_24_0	▼
WS Max WS - TR030_36_0	◆
WS Max WS - TR030_01_5	▲
WS Max WS - TR030_01_0	▲
WS Max WS - TR030_00_5	▲
Ground	■
Levee	□
Bank Sta	●

Studio Scandicci Torrenti Greve-Vingone
River = Fosso Dogaione Reach = Dogaione RS = 2.75 Culv

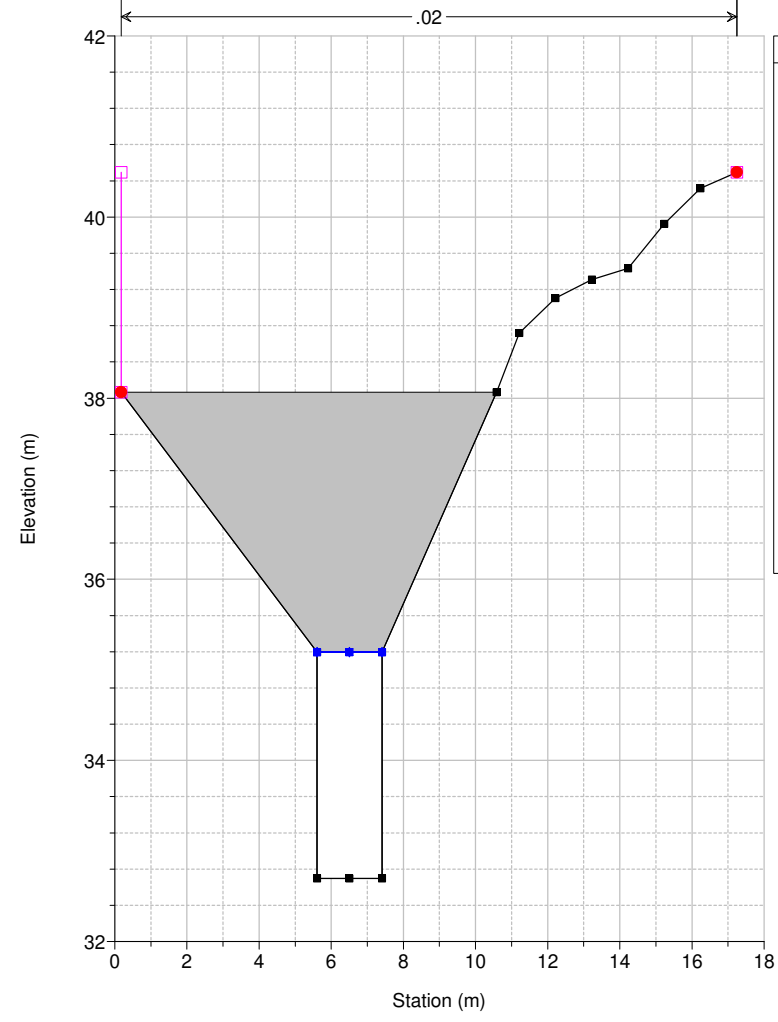

Legend	
WS Max WS - TR030_00_5	▲
WS Max WS - TR030_01_0	▲
WS Max WS - TR030_01_5	▲
WS Max WS - TR030_03_0	×
WS Max WS - TR030_06_0	■
WS Max WS - TR030_09_0	●
WS Max WS - TR030_12_0	+
WS Max WS - TR030_18_0	▼
WS Max WS - TR030_24_0	+
WS Max WS - TR030_36_0	◆
Ground	■
Levee	□
Bank Sta	●

Studio Scandicci Torrenti Greve-Vingone
River = Fosso Dogaione Reach = Dogaione RS = 2.75 Culv

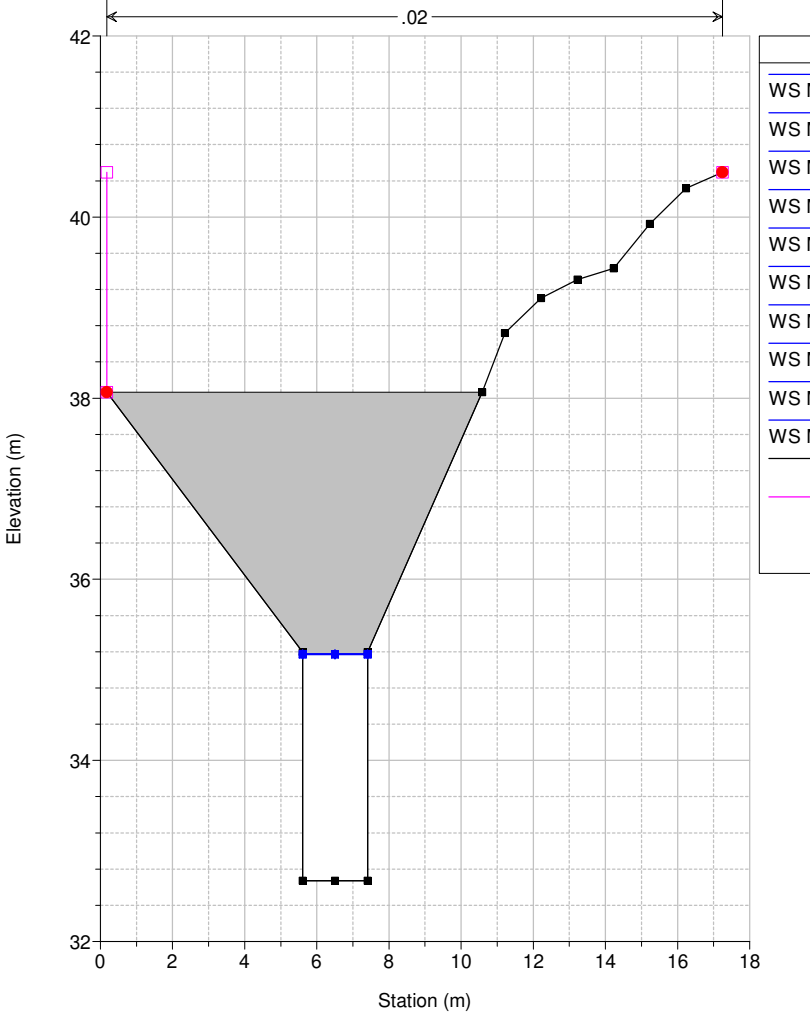

Legend	
WS Max WS - TR030_00_5	▲
WS Max WS - TR030_01_0	▲
WS Max WS - TR030_01_5	▲
WS Max WS - TR030_03_0	×
WS Max WS - TR030_06_0	■
WS Max WS - TR030_09_0	●
WS Max WS - TR030_12_0	+
WS Max WS - TR030_18_0	▼
WS Max WS - TR030_24_0	+
WS Max WS - TR030_36_0	◆
Ground	■
Levee	□
Bank Sta	●

Studio Scandicci Torrenti Greve-Vingone
River = Fosso Dogaione Reach = Dogaione RS = 2.6

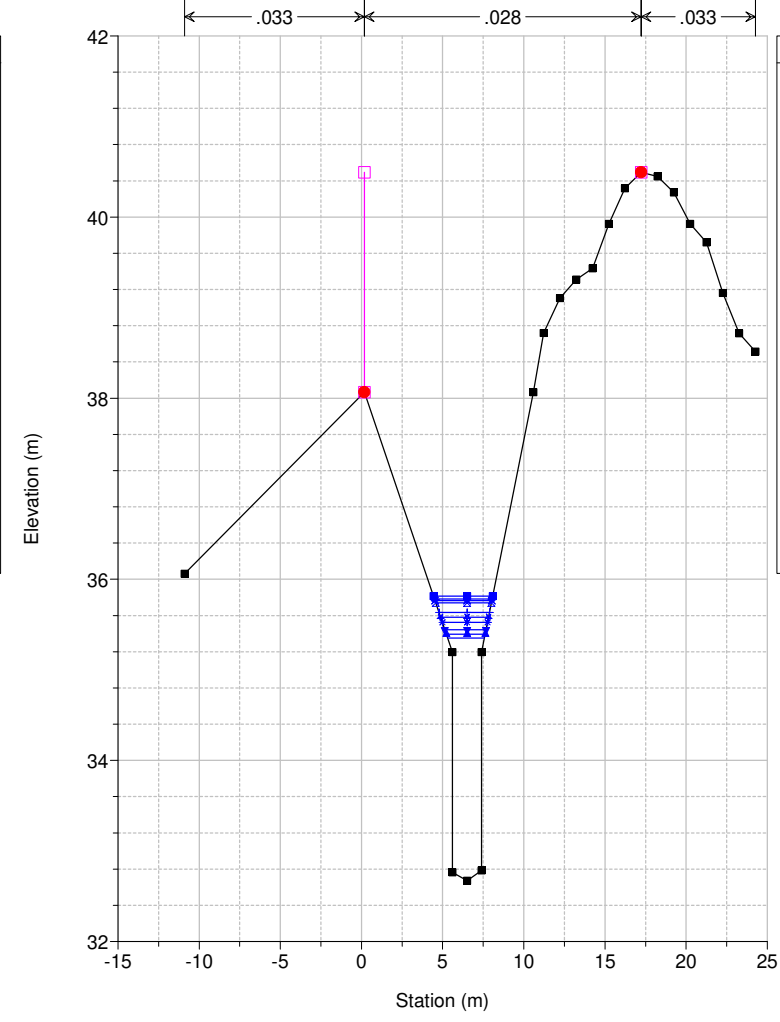

Legend	
WS Max WS - TR030_06_0	■
WS Max WS - TR030_09_0	●
WS Max WS - TR030_03_0	×
WS Max WS - TR030_12_0	+
WS Max WS - TR030_18_0	▲
WS Max WS - TR030_24_0	▼
WS Max WS - TR030_36_0	◆
WS Max WS - TR030_01_5	▲
WS Max WS - TR030_01_0	▲
WS Max WS - TR030_00_5	▲
Ground	■
Levee	□
Bank Sta	●

Studio Scandicci Torrenti Greve-Vingone
River = Fosso Dogaione Reach = Dogaione RS = 2.4

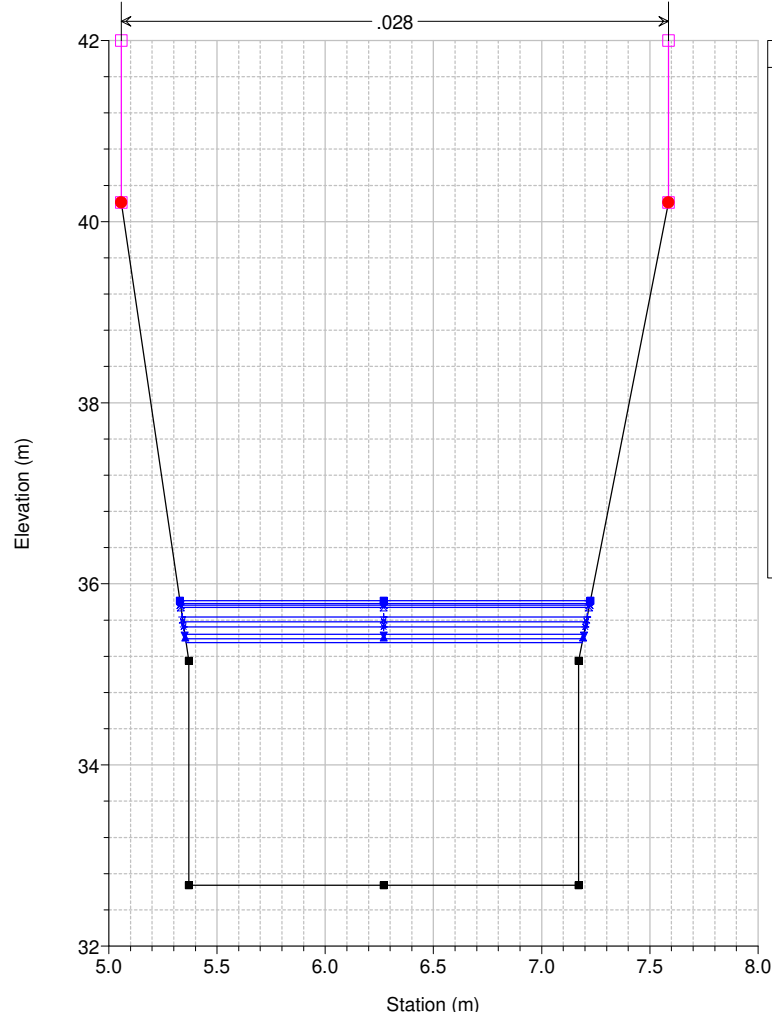

Studio Scandicci Torrenti Greve-Vingone
River = Fosso Dogaione Reach = Dogaione RS = 2.25 IS

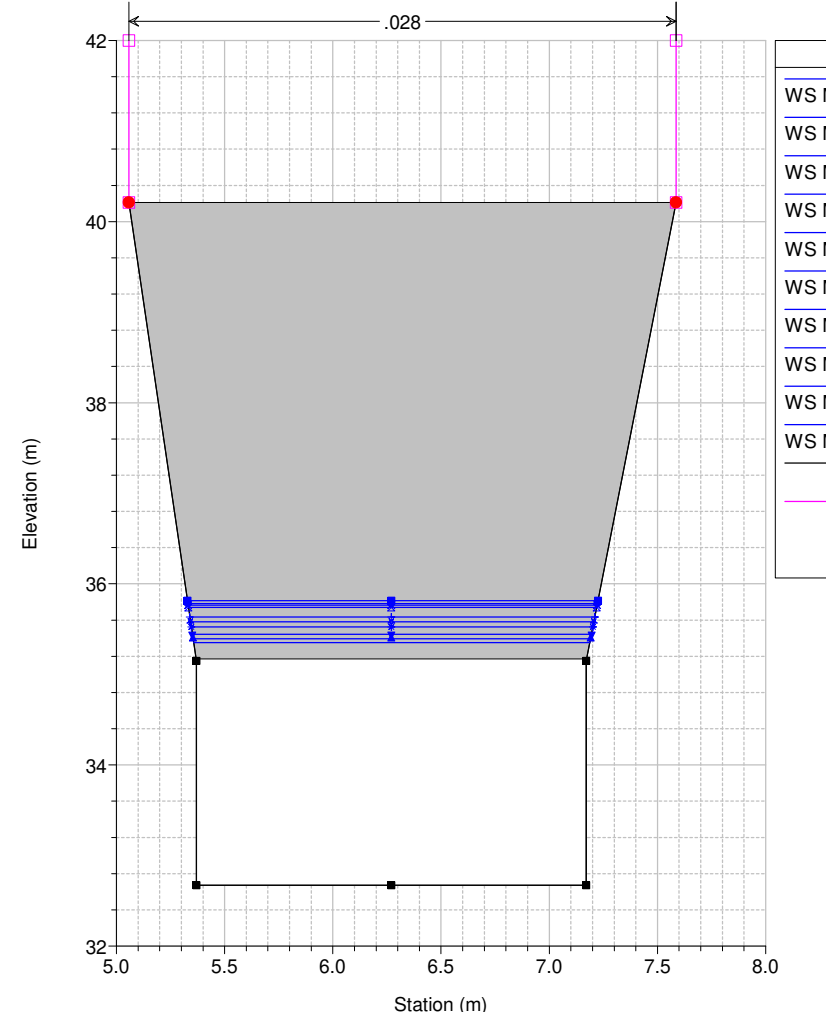

Studio Scandicci Torrenti Greve-Vingone
River = Fosso Dogaione Reach = Dogaione RS = 2 DG0018_C

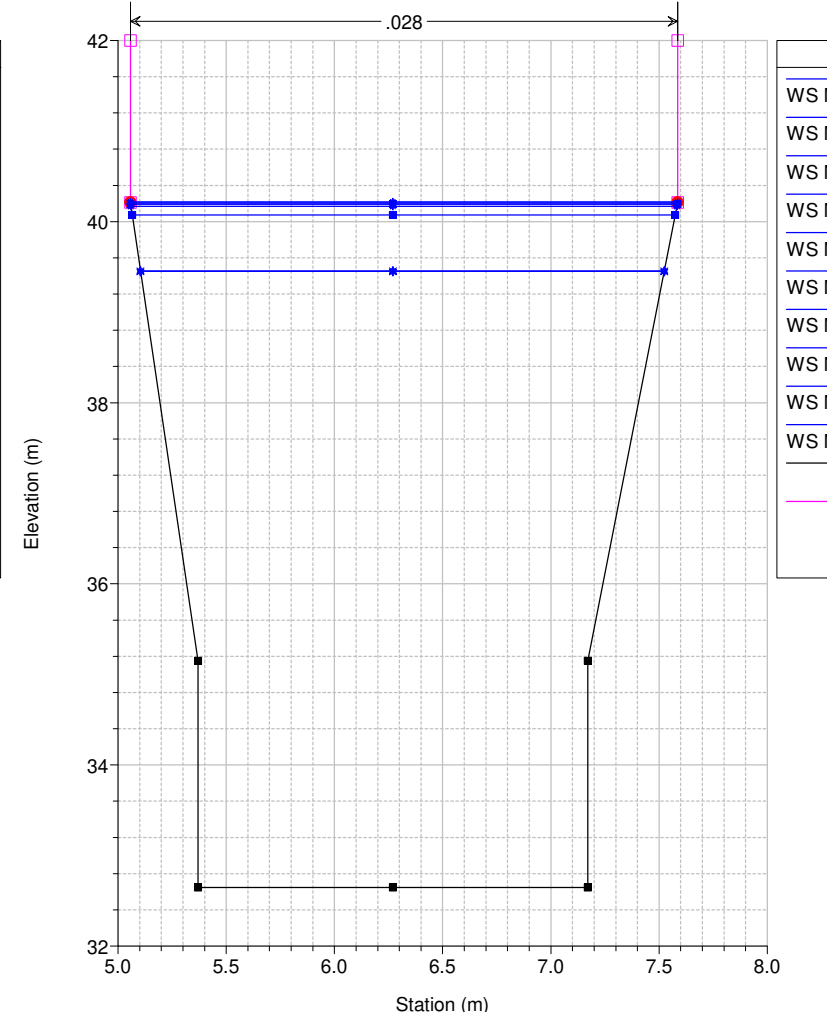

Studio Scandicci Torrenti Greve-Vingone
River = Fosso Dogaione Reach = Dogaione RS = 1 DG0018_D

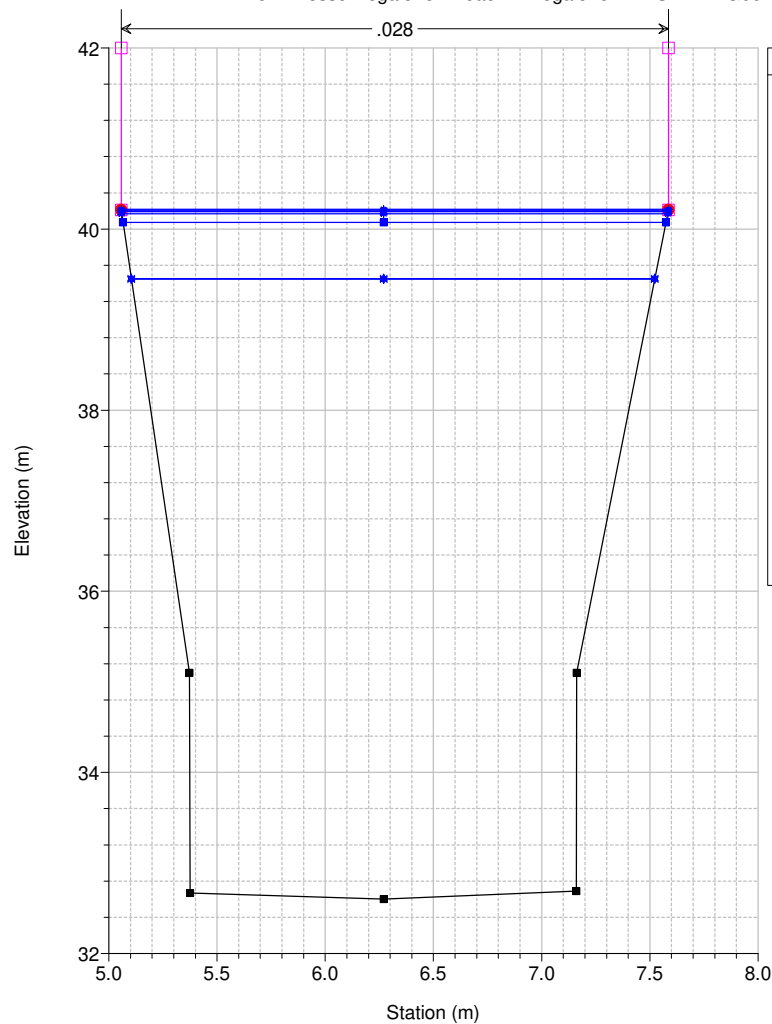

Studio Scandicci Torrenti Greve-Vingone
River = Fosso Dogaione Reach = Dogaione RS = 0.5 AR0521

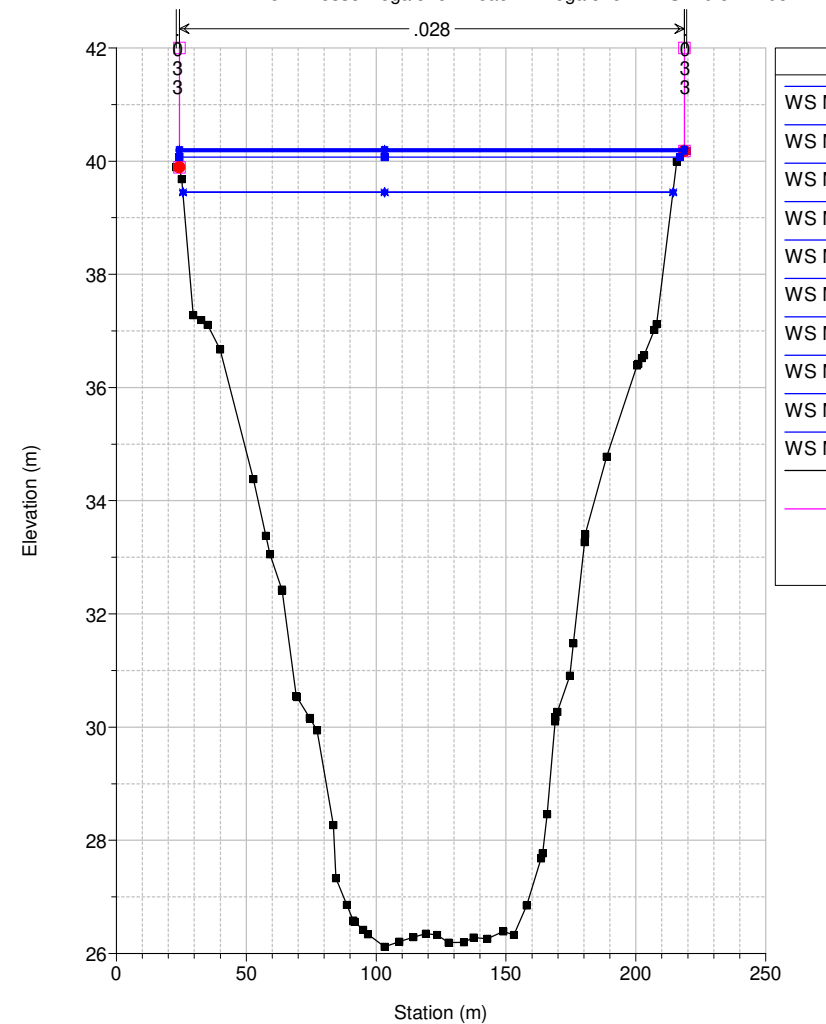

Studio Scandicci Torrenti Greve-Vingone
River = Fosso Rigone Reach = Rigone 03 RS = 63 RI0001_D

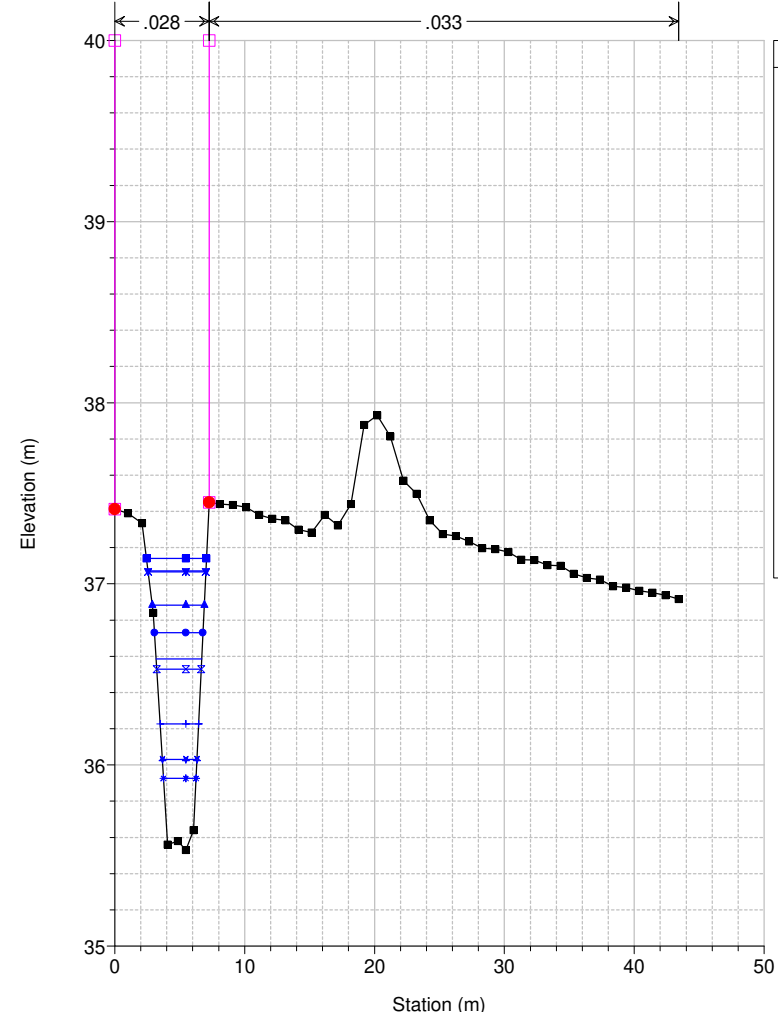

Legend	
WS Max WS - TR030_06_0	■
WS Max WS - TR030_01_5	▼
WS Max WS - TR030_03_0	×
WS Max WS - TR030_01_0	▲
WS Max WS - TR030_09_0	●
WS Max WS - TR030_00_5	+
WS Max WS - TR030_12_0	×
WS Max WS - TR030_18_0	+
WS Max WS - TR030_24_0	+
WS Max WS - TR030_36_0	+
Ground	■
Levee	□
Bank Sta	●

Studio Scandicci Torrenti Greve-Vingone
River = Fosso Rigone Reach = Rigone 03 RS = 62 RI0002_

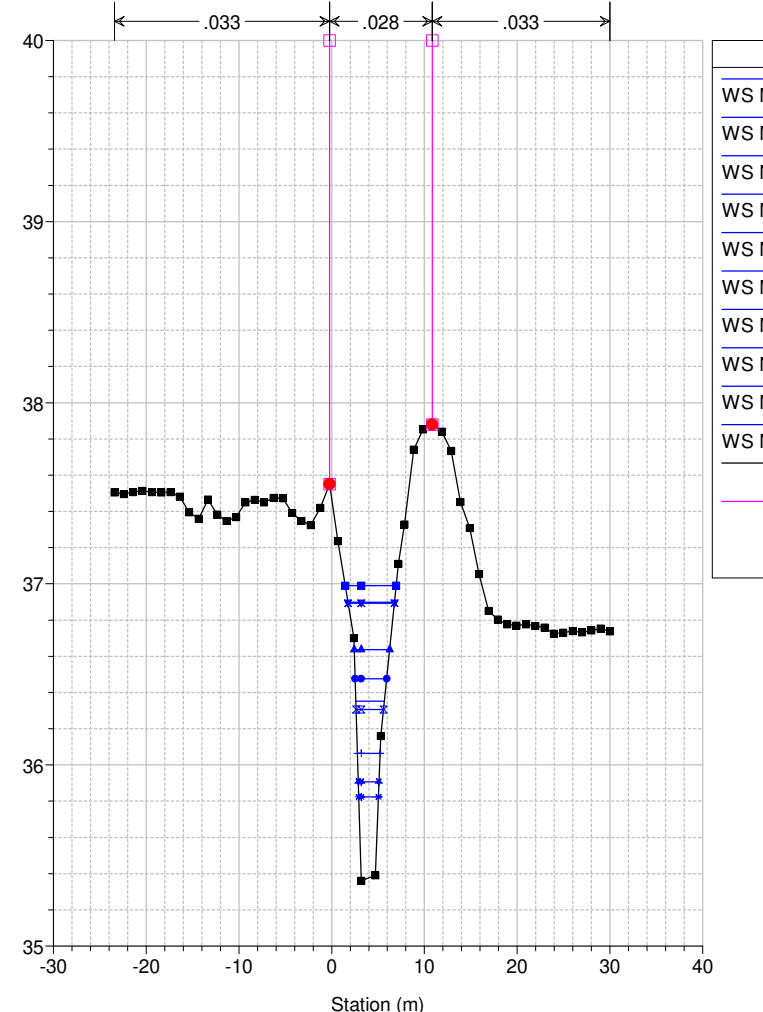

Legend	
WS Max WS - TR030_06_0	■
WS Max WS - TR030_01_5	▼
WS Max WS - TR030_03_0	×
WS Max WS - TR030_01_0	▲
WS Max WS - TR030_09_0	●
WS Max WS - TR030_00_5	+
WS Max WS - TR030_12_0	×
WS Max WS - TR030_18_0	+
WS Max WS - TR030_24_0	+
WS Max WS - TR030_36_0	+
Ground	■
Levee	□
Bank Sta	●

Studio Scandicci Torrenti Greve-Vingone
River = Fosso Rigone Reach = Rigone 03 RS = 61 RI0003_

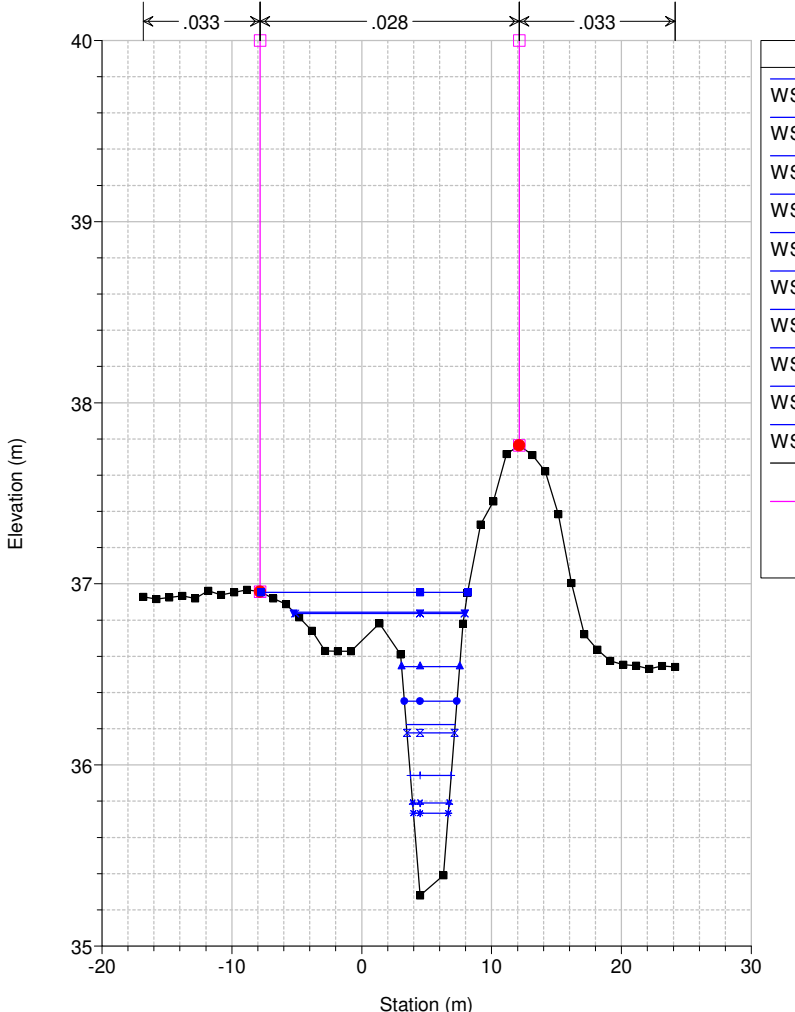

Legend	
WS Max WS - TR030_06_0	■
WS Max WS - TR030_01_5	▼
WS Max WS - TR030_03_0	×
WS Max WS - TR030_01_0	▲
WS Max WS - TR030_09_0	●
WS Max WS - TR030_00_5	+
WS Max WS - TR030_12_0	×
WS Max WS - TR030_18_0	+
WS Max WS - TR030_24_0	+
WS Max WS - TR030_36_0	+
Ground	■
Levee	□
Bank Sta	●

Studio Scandicci Torrenti Greve-Vingone
River = Fosso Rigone Reach = Rigone 03 RS = 60 RI0004_

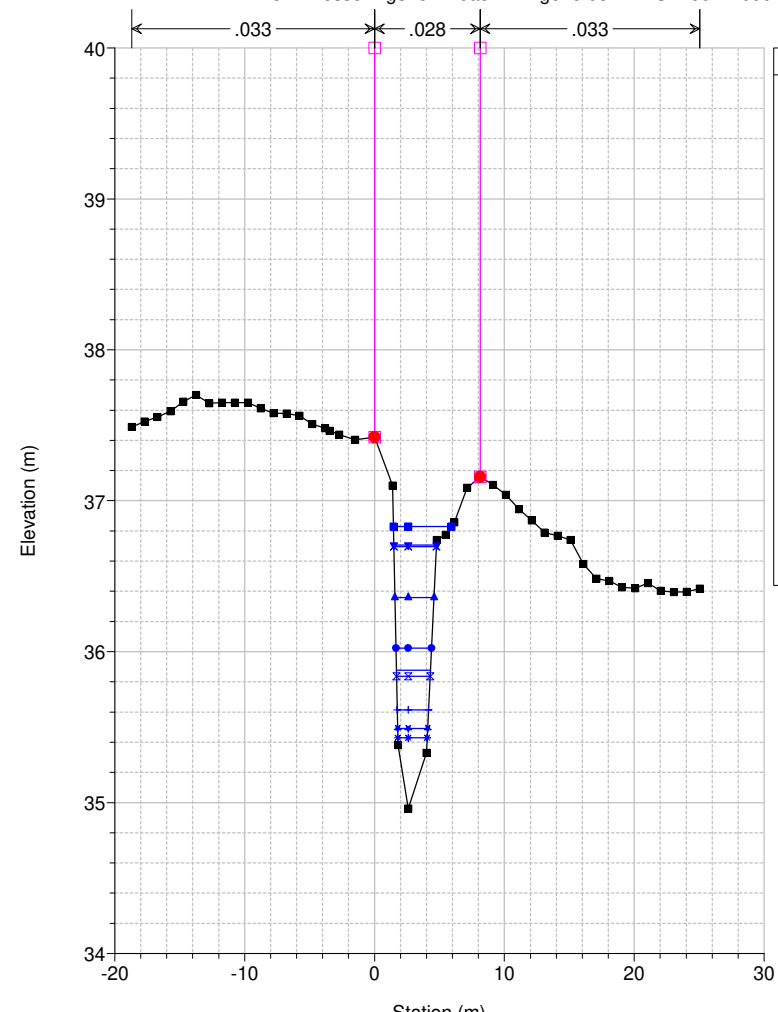

Legend	
WS Max WS - TR030_06_0	■
WS Max WS - TR030_01_5	▼
WS Max WS - TR030_03_0	×
WS Max WS - TR030_01_0	▲
WS Max WS - TR030_09_0	●
WS Max WS - TR030_00_5	+
WS Max WS - TR030_12_0	×
WS Max WS - TR030_18_0	+
WS Max WS - TR030_24_0	+
WS Max WS - TR030_36_0	+
Ground	■
Levee	□
Bank Sta	●

Studio Scandicci Torrenti Greve-Vingone
River = Fosso Rigone Reach = Rigone 03 RS = 59 RI0005_A

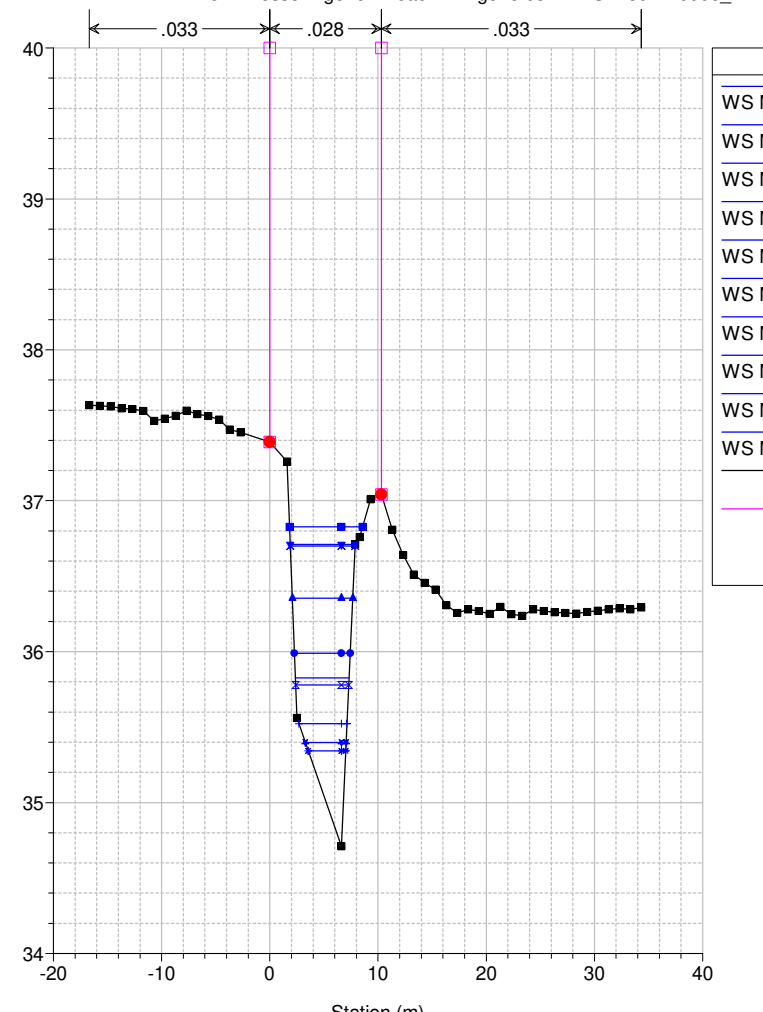

Legend	
WS Max WS - TR030_06_0	■
WS Max WS - TR030_01_5	▼
WS Max WS - TR030_03_0	×
WS Max WS - TR030_01_0	▲
WS Max WS - TR030_09_0	●
WS Max WS - TR030_00_5	+
WS Max WS - TR030_12_0	×
WS Max WS - TR030_18_0	+
WS Max WS - TR030_24_0	+
WS Max WS - TR030_36_0	+
Ground	■
Levee	□
Bank Sta	●

Studio Scandicci Torrenti Greve-Vingone
River = Fosso Rigone Reach = Rigone 03 RS = 58 RI0005_B

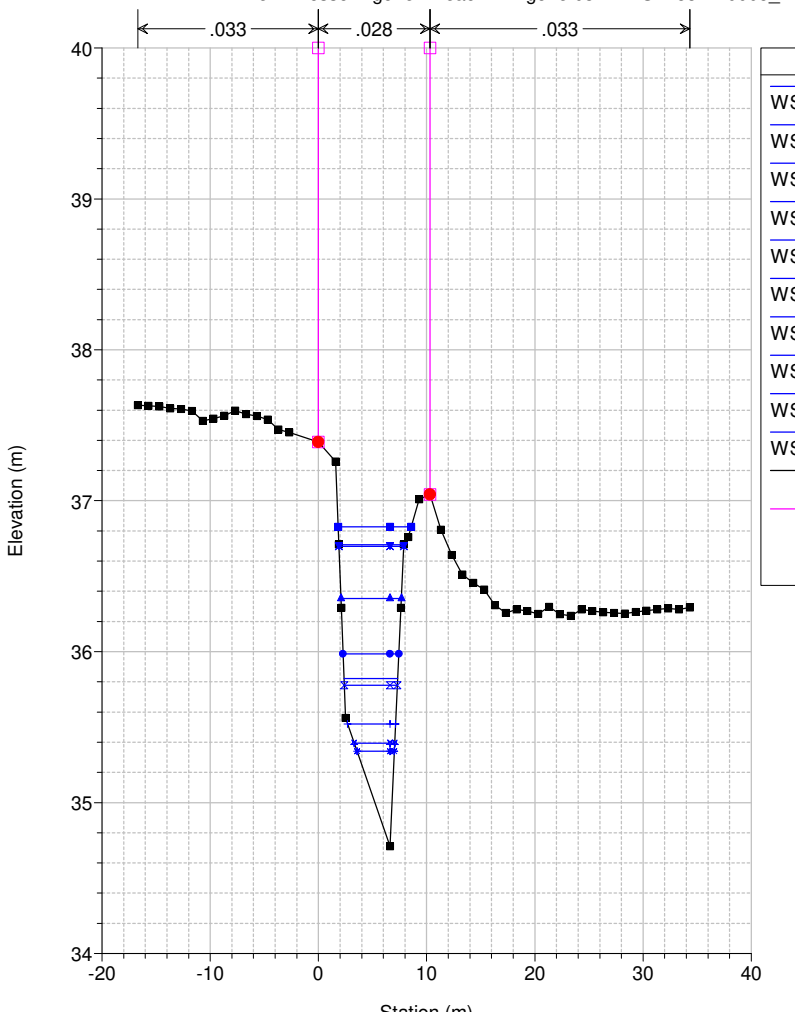

Legend	
WS Max WS - TR030_06_0	■
WS Max WS - TR030_01_5	▼
WS Max WS - TR030_03_0	×
WS Max WS - TR030_01_0	▲
WS Max WS - TR030_09_0	●
WS Max WS - TR030_00_5	+
WS Max WS - TR030_12_0	×
WS Max WS - TR030_18_0	+
WS Max WS - TR030_24_0	+
WS Max WS - TR030_36_0	+
Ground	■
Levee	□
Bank Sta	●

Studio Scandicci Torrenti Greve-Vingone
River = Fosso Rigone Reach = Rigone 03 RS = 57.75 BR

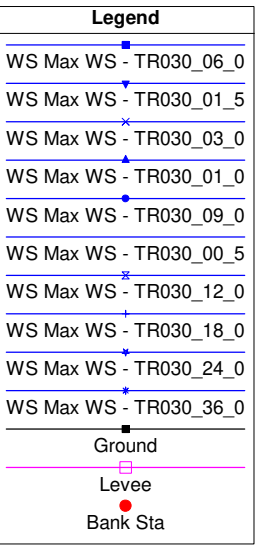
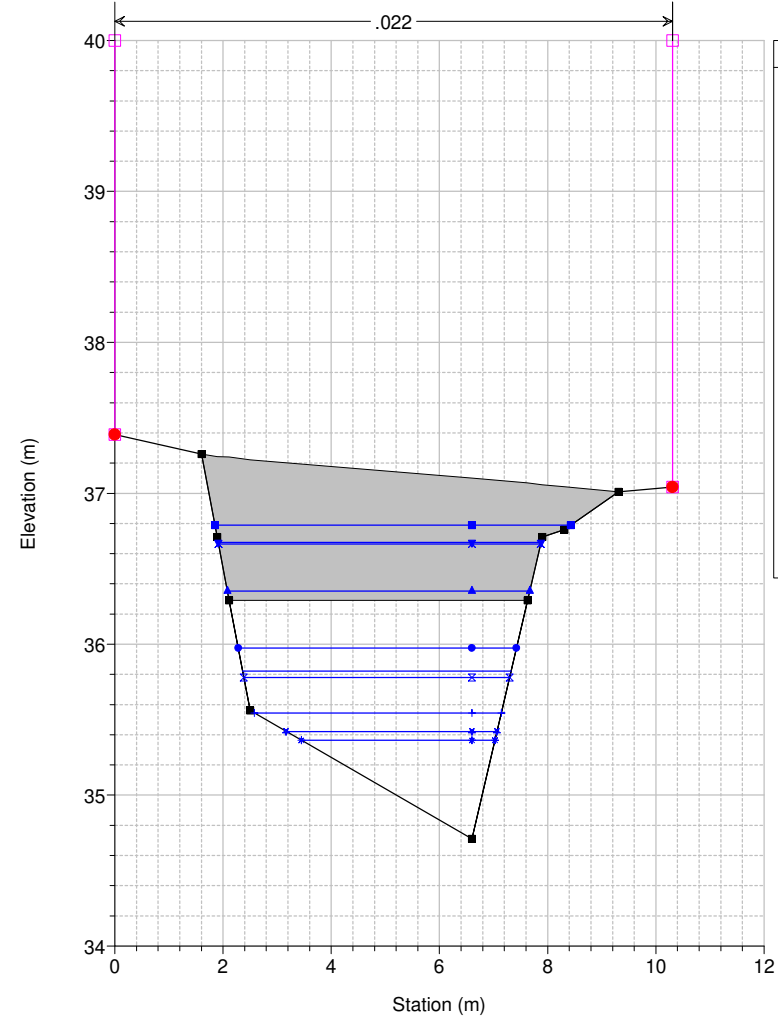

Studio Scandicci Torrenti Greve-Vingone
River = Fosso Rigone Reach = Rigone 03 RS = 57.75 BR

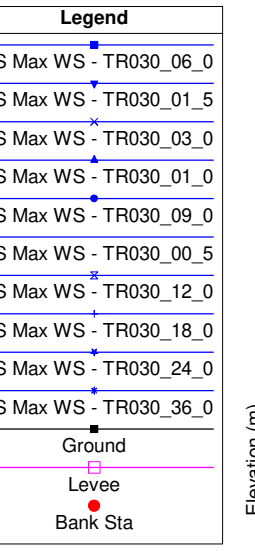
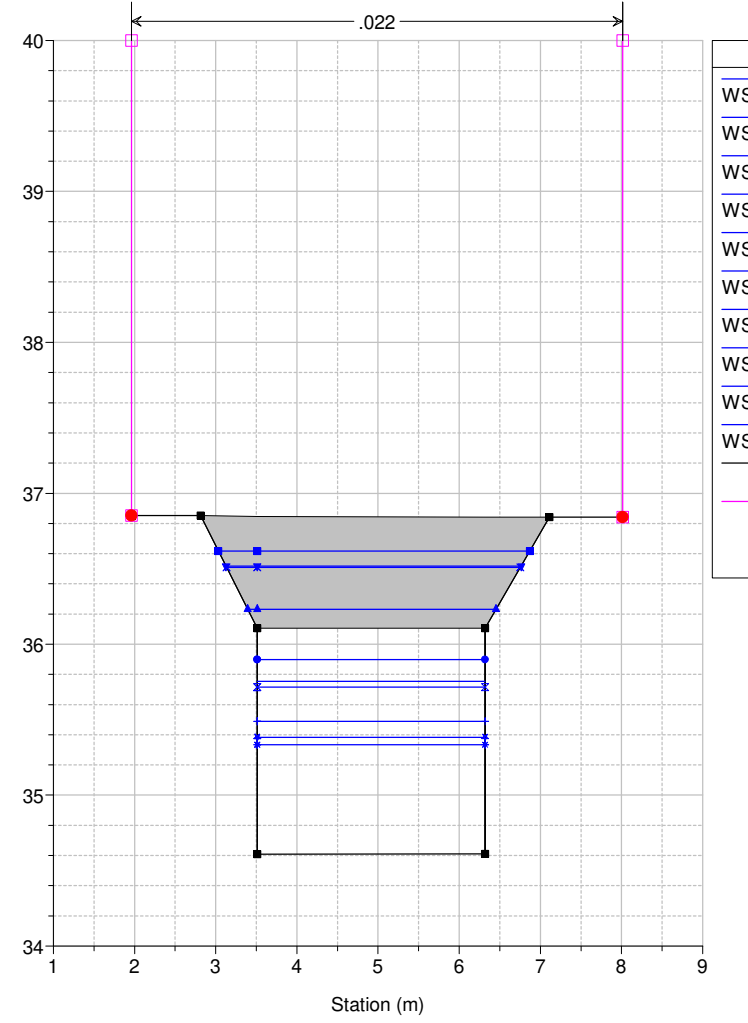

Studio Scandicci Torrenti Greve-Vingone
River = Fosso Rigone Reach = Rigone 03 RS = 57.4

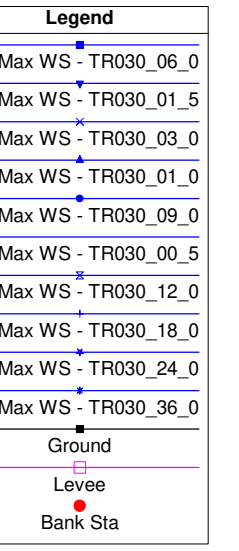
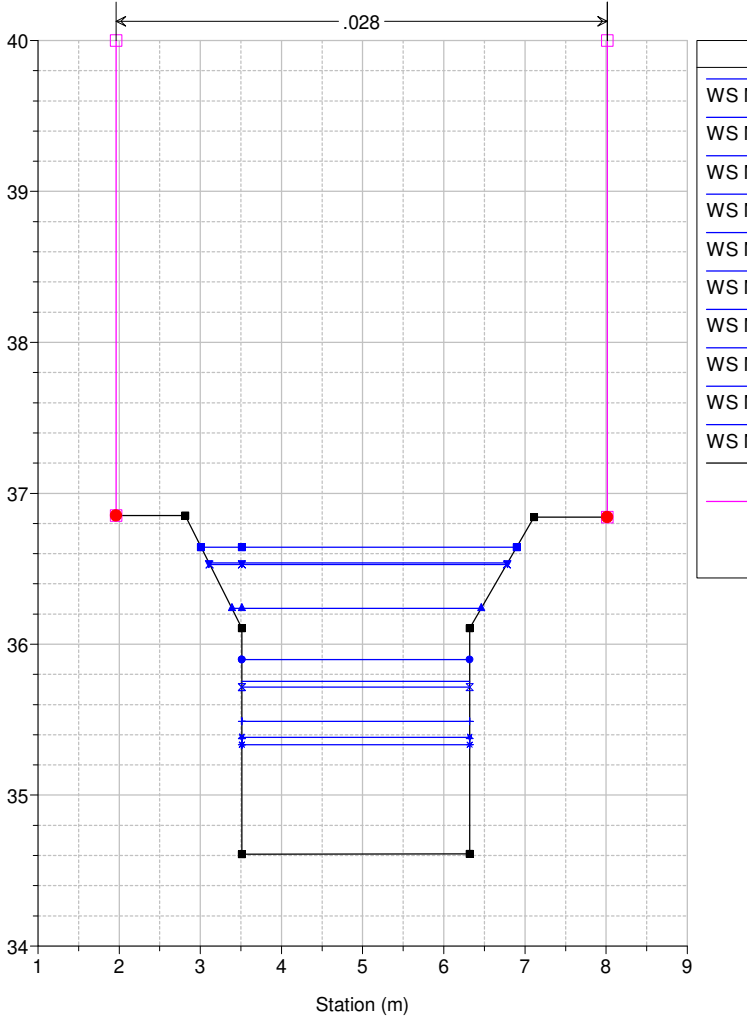

Studio Scandicci Torrenti Greve-Vingone
River = Fosso Rigone Reach = Rigone 03 RS = 57 RI0005_C

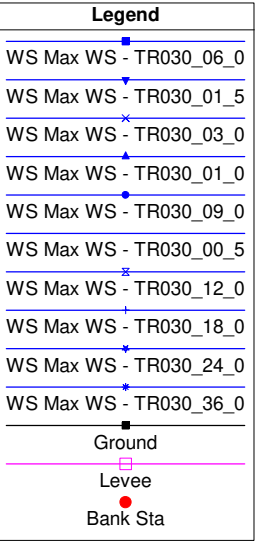
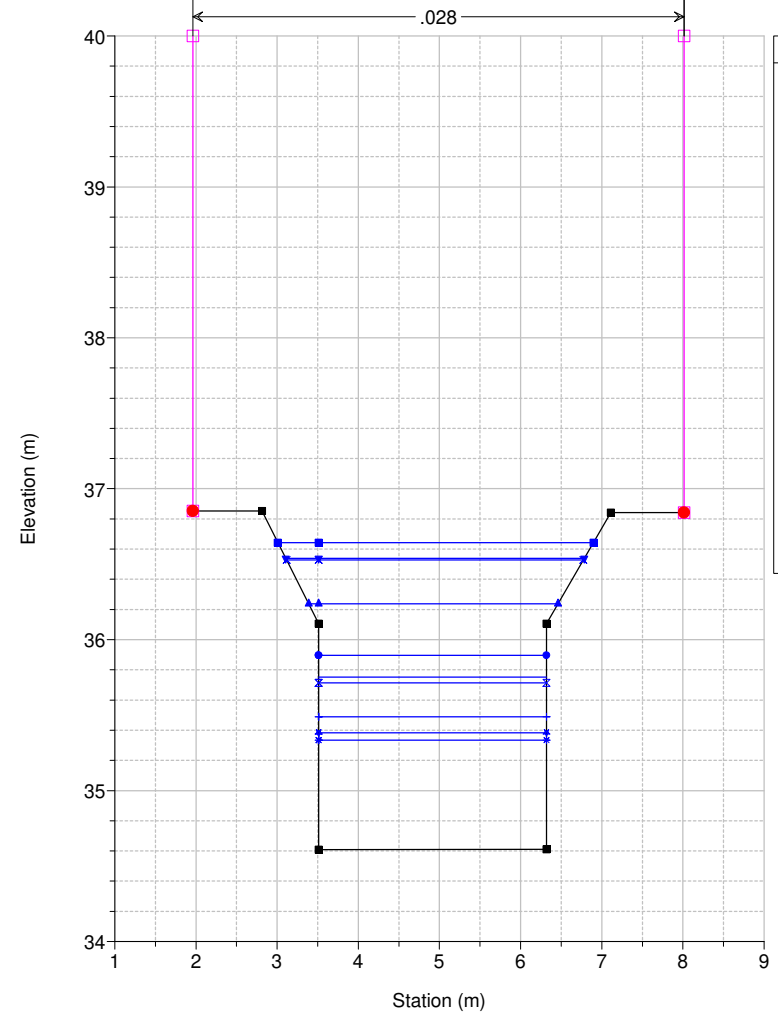

Studio Scandicci Torrenti Greve-Vingone
River = Fosso Rigone Reach = Rigone 03 RS = 56.75 Culv

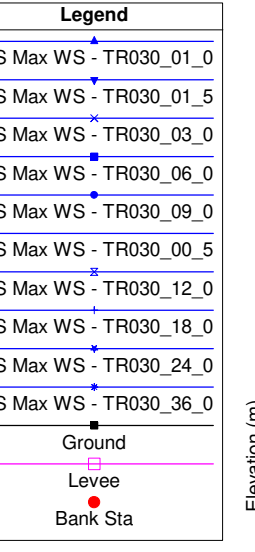
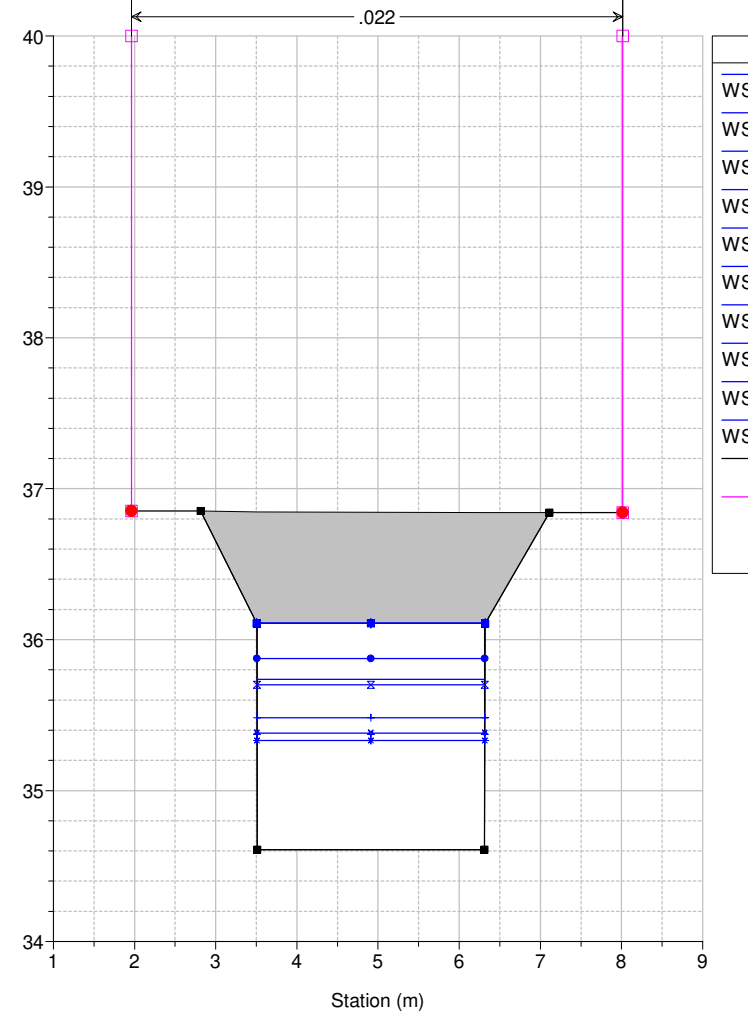

Studio Scandicci Torrenti Greve-Vingone
River = Fosso Rigone Reach = Rigone 03 RS = 56.75 Culv

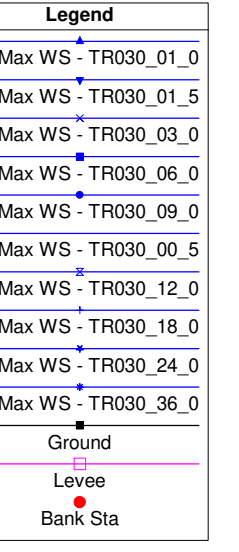
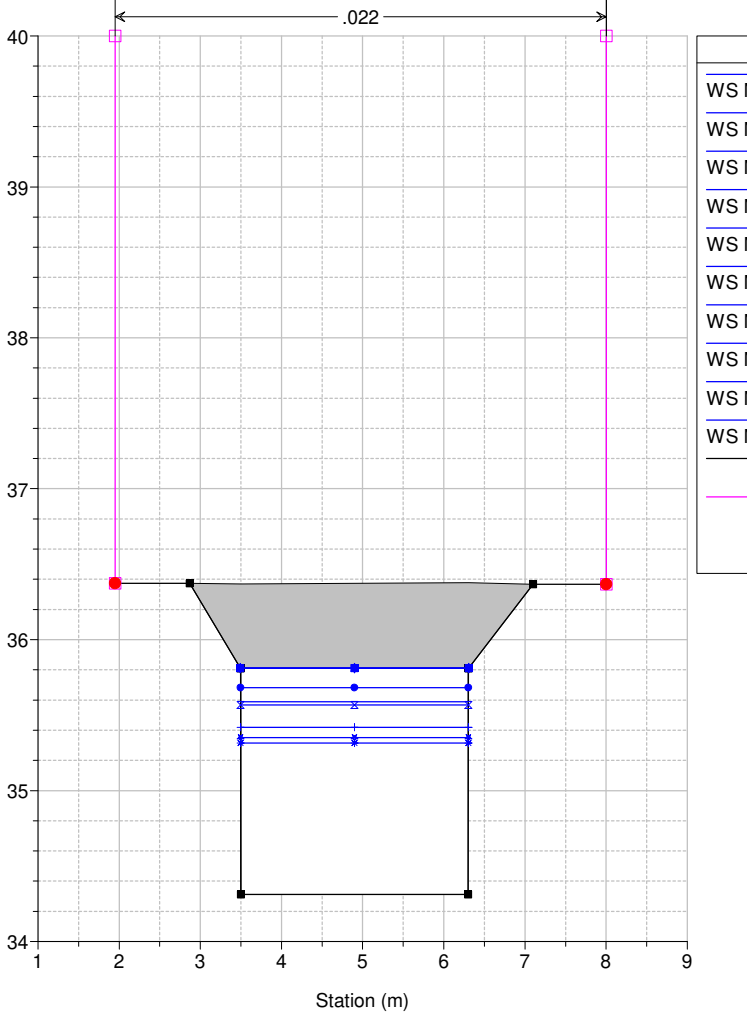

Studio Scandicci Torrenti Greve-Vingone
River = Fosso Rigone Reach = Rigone 03 RS = 56.4

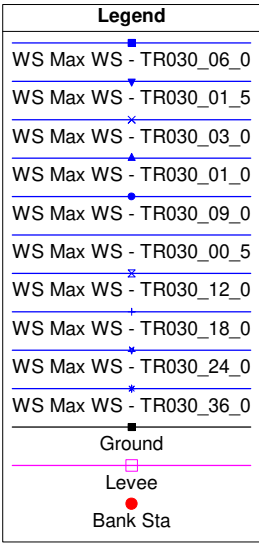
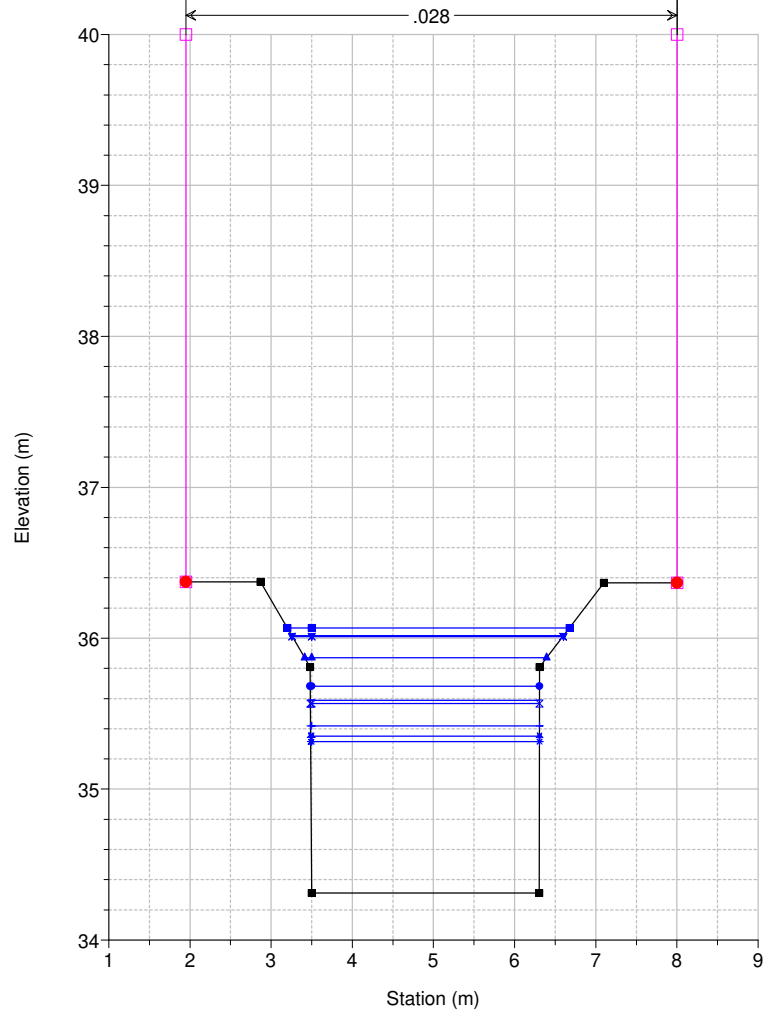

Studio Scandicci Torrenti Greve-Vingone
River = Fosso Rigone Reach = Rigone 03 RS = 56 RI0005_D

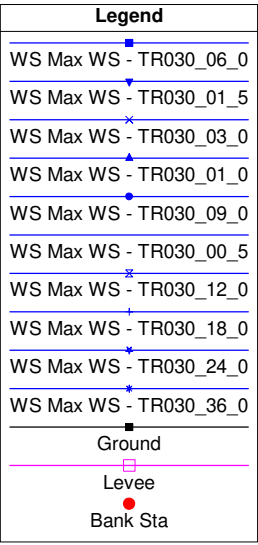
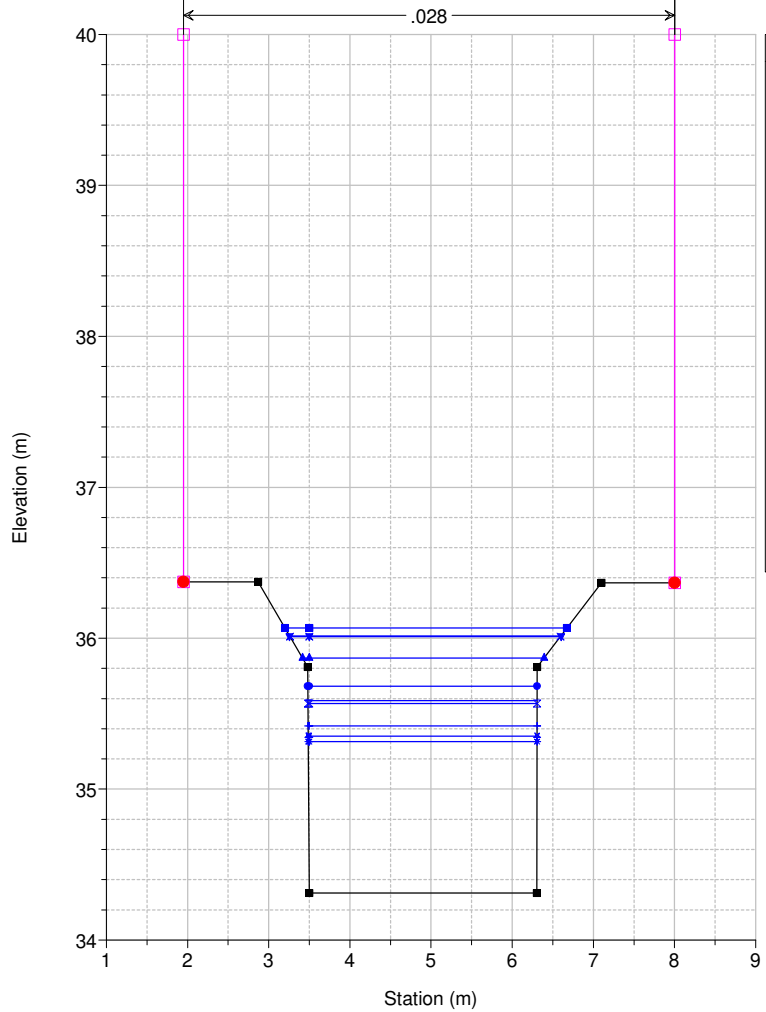

Studio Scandicci Torrenti Greve-Vingone
River = Fosso Rigone Reach = Rigone 03 RS = 55.75 BR

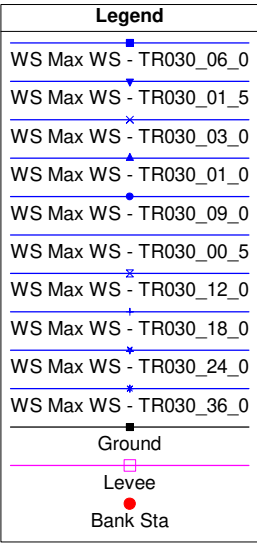
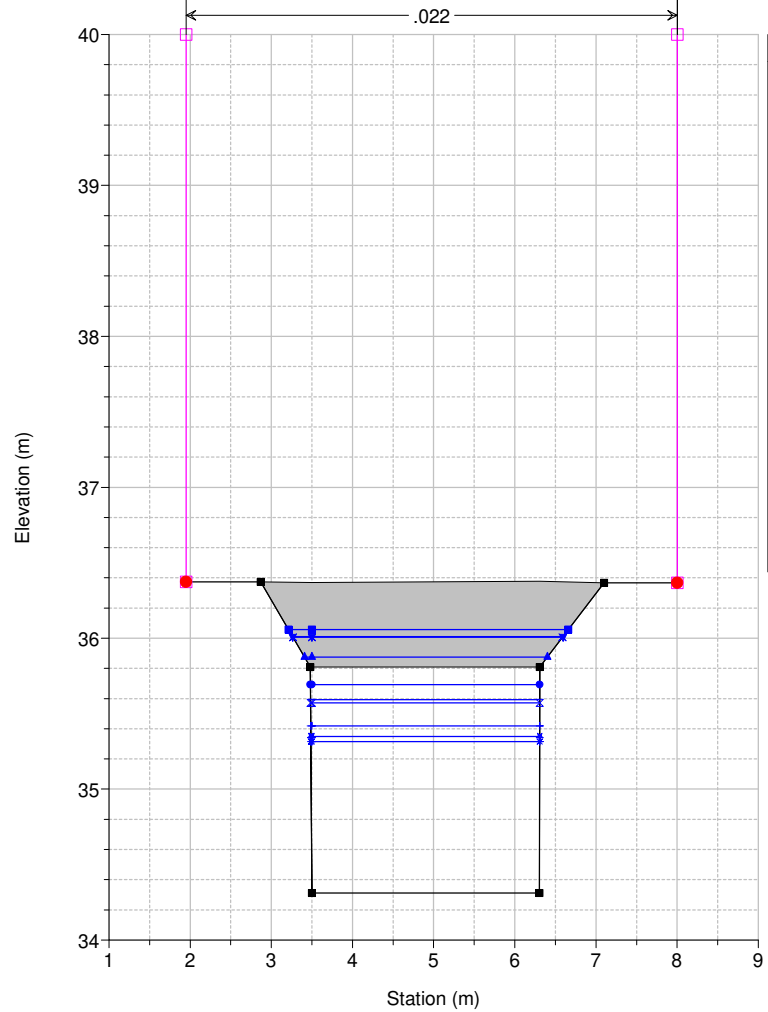

Studio Scandicci Torrenti Greve-Vingone
River = Fosso Rigone Reach = Rigone 03 RS = 55.75 BR

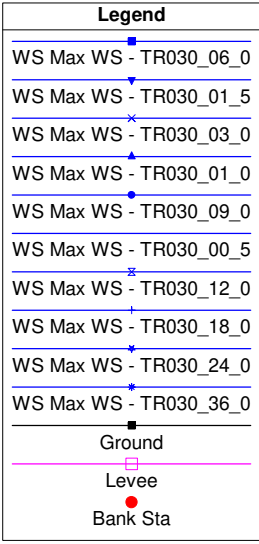
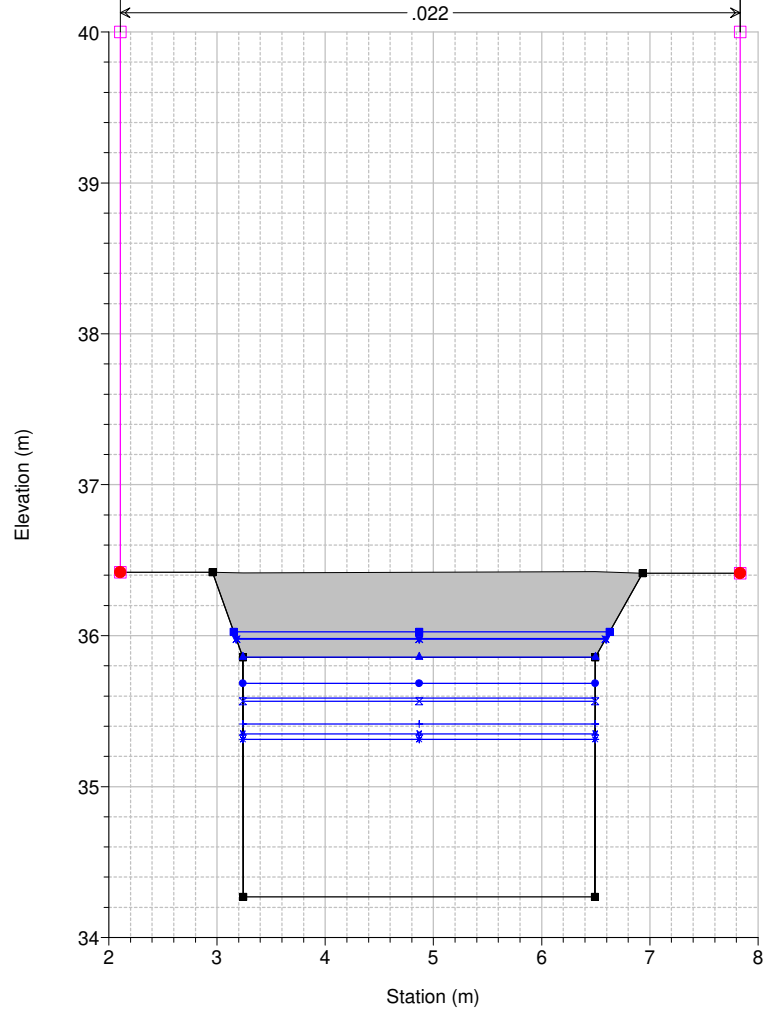

Studio Scandicci Torrenti Greve-Vingone
River = Fosso Rigone Reach = Rigone 03 RS = 55.4

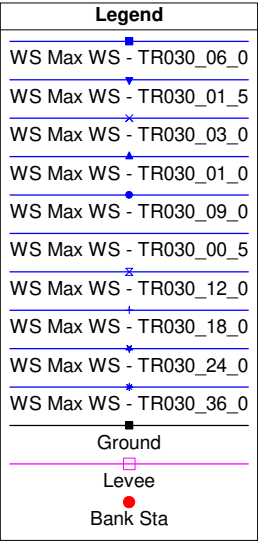
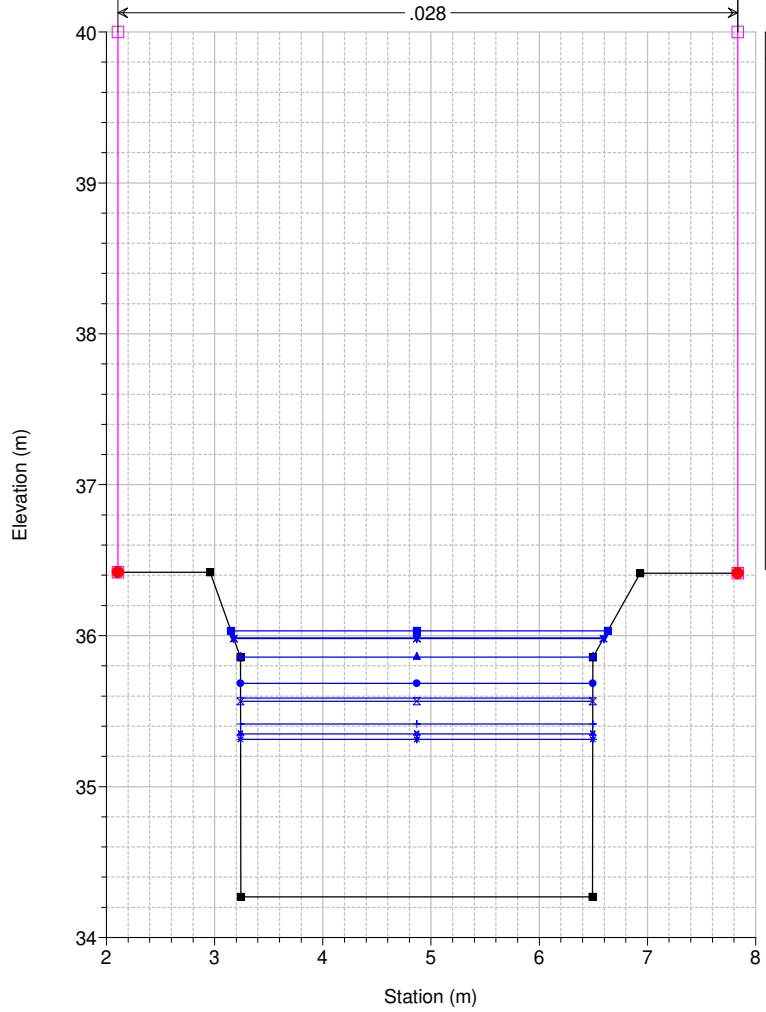

Studio Scandicci Torrenti Greve-Vingone
River = Fosso Rigone Reach = Rigone 03 RS = 55 RI0006_A

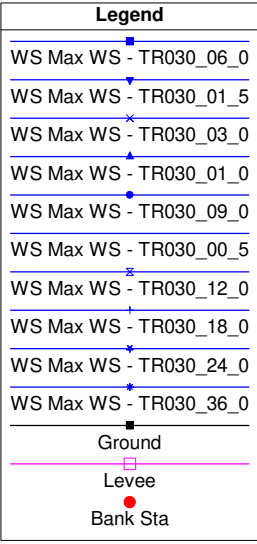
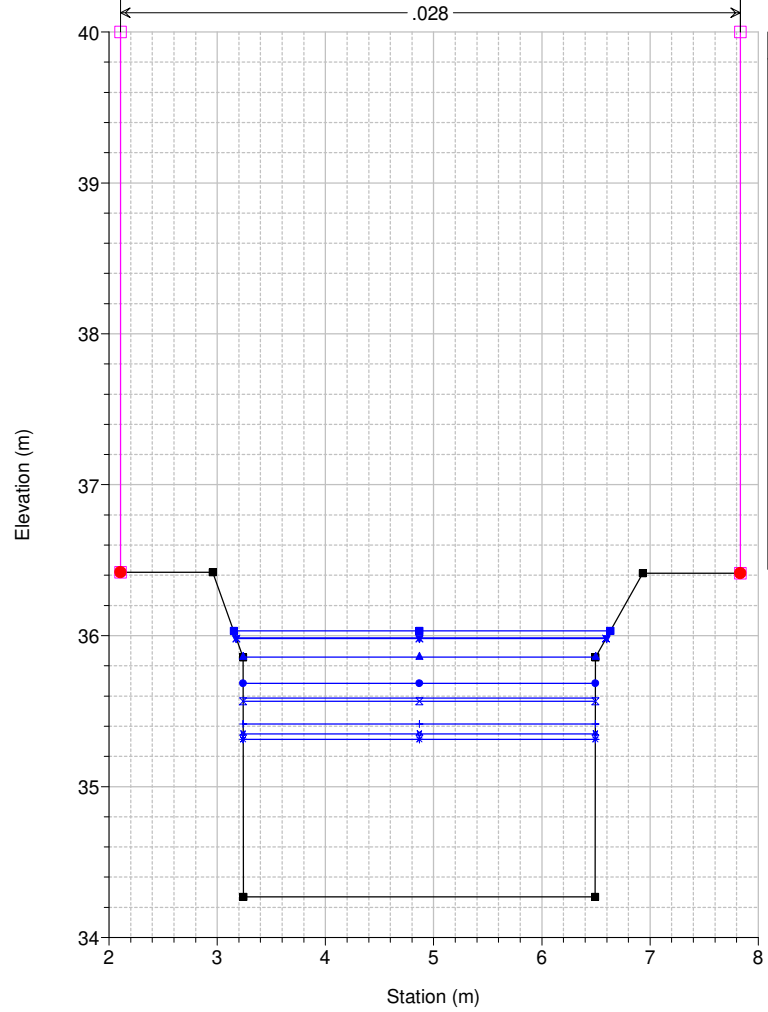

Studio Scandicci Torrenti Greve-Vingone
River = Fosso Rigone Reach = Rigone 03 RS = 54.5 Culv

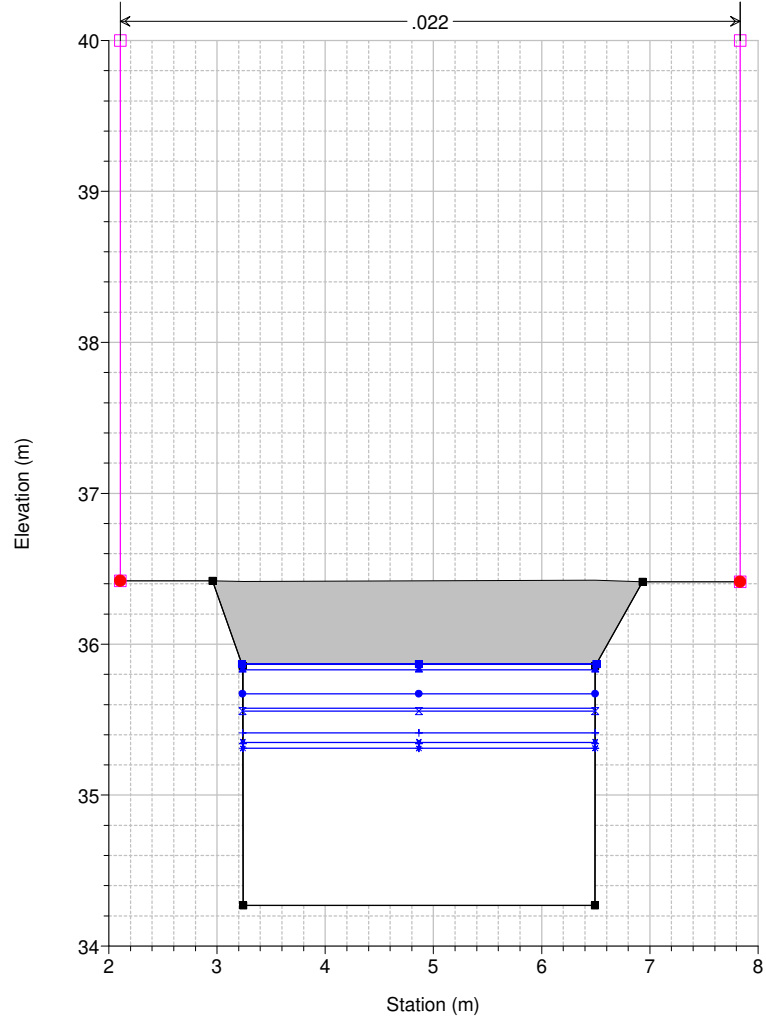

Legend	
WS Max WS - TR030_01_5	▼
WS Max WS - TR030_03_0	×
WS Max WS - TR030_06_0	■
WS Max WS - TR030_01_0	▲
WS Max WS - TR030_09_0	●
WS Max WS - TR030_00_5	+
WS Max WS - TR030_12_0	×
WS Max WS - TR030_18_0	+
WS Max WS - TR030_24_0	+
WS Max WS - TR030_36_0	+
Ground	■
Levee	□
Bank Sta	●

Studio Scandicci Torrenti Greve-Vingone
River = Fosso Rigone Reach = Rigone 03 RS = 54.5 Culv

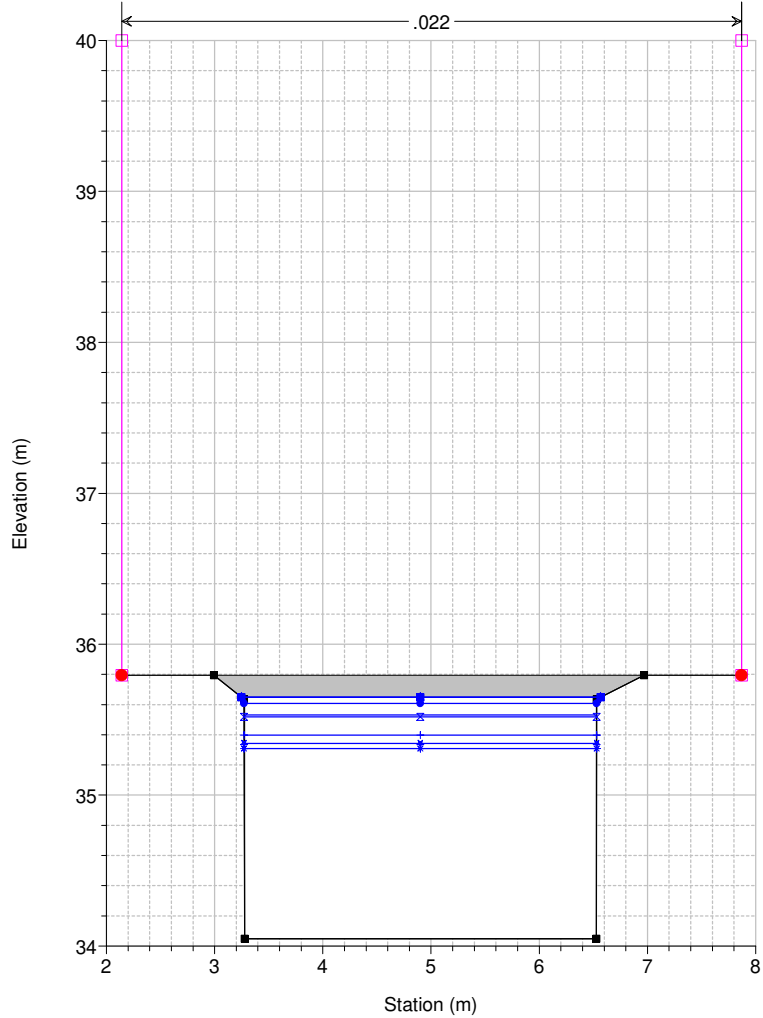

Legend	
WS Max WS - TR030_01_0	▲
WS Max WS - TR030_01_5	▼
WS Max WS - TR030_03_0	×
WS Max WS - TR030_06_0	■
WS Max WS - TR030_09_0	●
WS Max WS - TR030_00_5	+
WS Max WS - TR030_12_0	×
WS Max WS - TR030_18_0	+
WS Max WS - TR030_24_0	+
WS Max WS - TR030_36_0	+
Ground	■
Levee	□
Bank Sta	●

Studio Scandicci Torrenti Greve-Vingone
River = Fosso Rigone Reach = Rigone 03 RS = 54.4

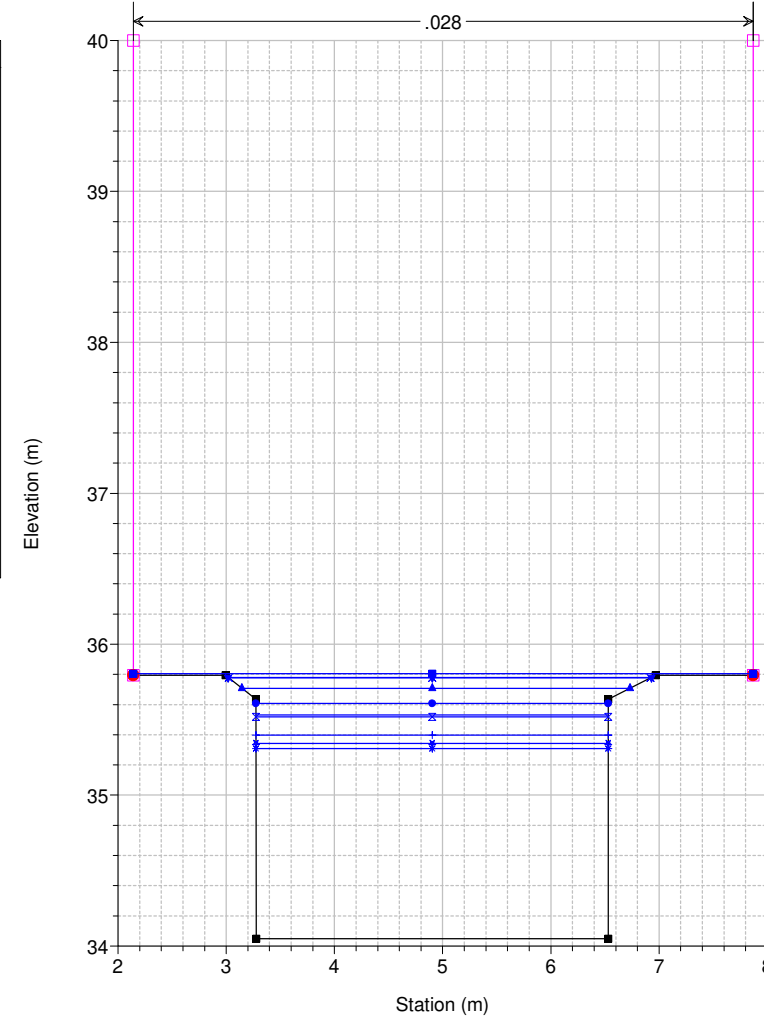

Legend	
WS Max WS - TR030_06_0	■
WS Max WS - TR030_01_5	▼
WS Max WS - TR030_03_0	×
WS Max WS - TR030_01_0	▲
WS Max WS - TR030_09_0	●
WS Max WS - TR030_00_5	+
WS Max WS - TR030_12_0	×
WS Max WS - TR030_18_0	+
WS Max WS - TR030_24_0	+
WS Max WS - TR030_36_0	+
Ground	■
Levee	□
Bank Sta	●

Studio Scandicci Torrenti Greve-Vingone
River = Fosso Rigone Reach = Rigone 03 RS = 54 RI0006_B

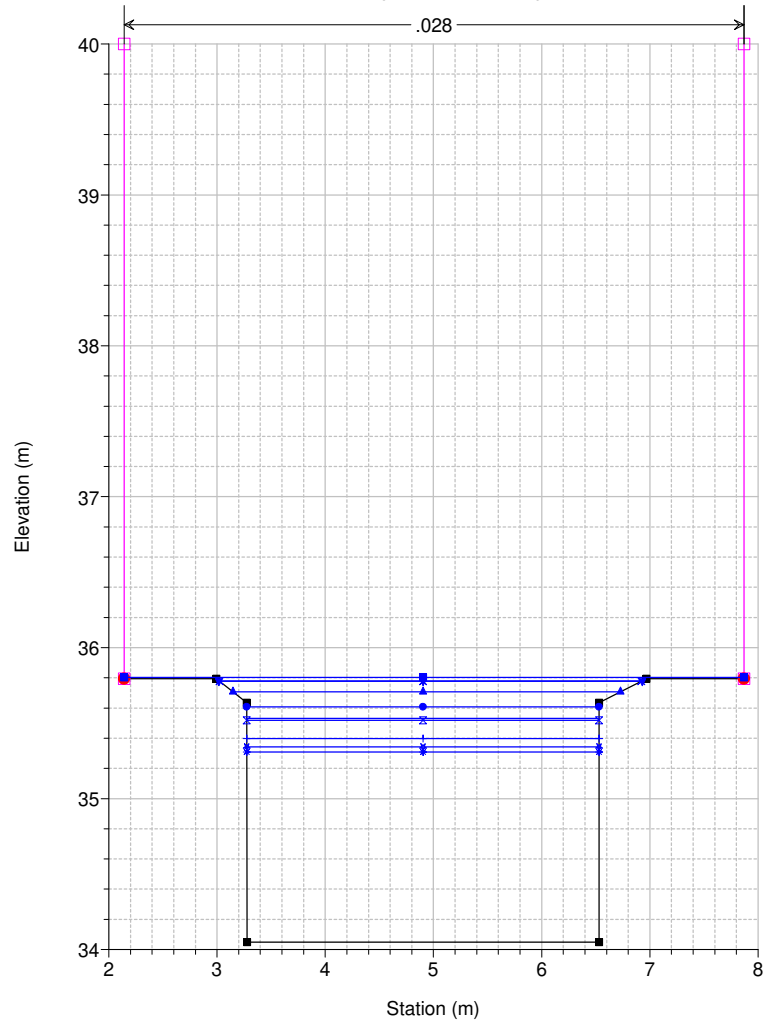

Legend	
WS Max WS - TR030_06_0	■
WS Max WS - TR030_01_5	▼
WS Max WS - TR030_03_0	×
WS Max WS - TR030_01_0	▲
WS Max WS - TR030_09_0	●
WS Max WS - TR030_00_5	+
WS Max WS - TR030_12_0	×
WS Max WS - TR030_18_0	+
WS Max WS - TR030_24_0	+
WS Max WS - TR030_36_0	+
Ground	■
Levee	□
Bank Sta	●

Studio Scandicci Torrenti Greve-Vingone
River = Fosso Rigone Reach = Rigone 03 RS = 53.5 BR

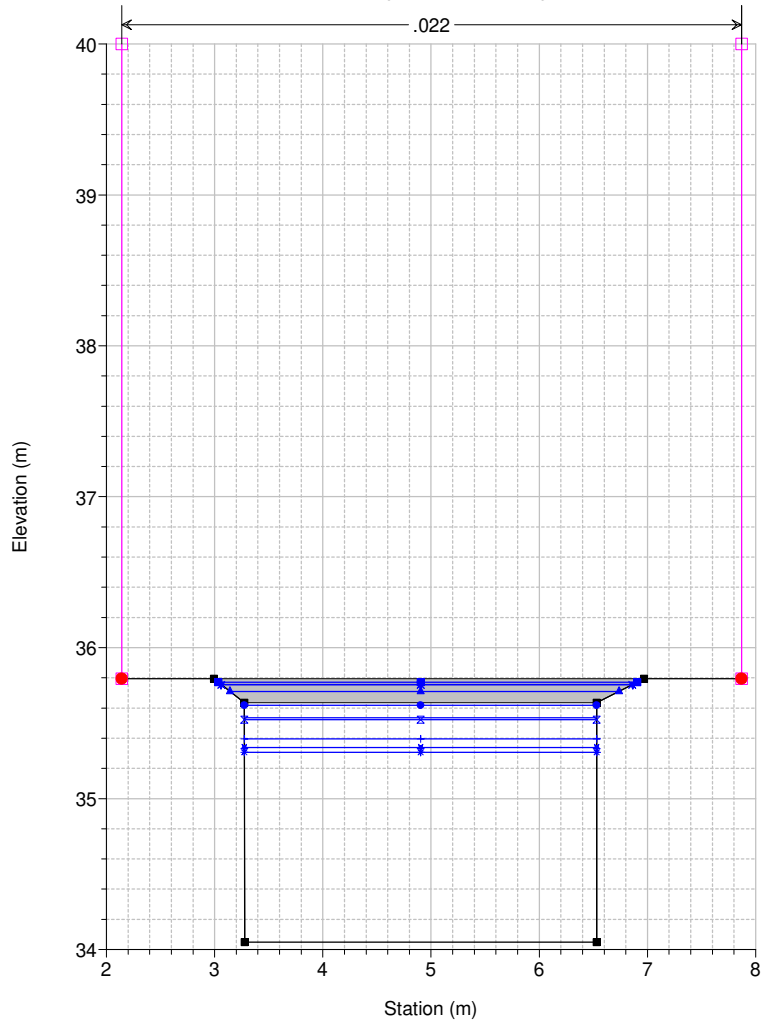

Legend	
WS Max WS - TR030_06_0	■
WS Max WS - TR030_01_5	▼
WS Max WS - TR030_03_0	×
WS Max WS - TR030_01_0	▲
WS Max WS - TR030_09_0	●
WS Max WS - TR030_00_5	+
WS Max WS - TR030_12_0	×
WS Max WS - TR030_18_0	+
WS Max WS - TR030_24_0	+
WS Max WS - TR030_36_0	+
Ground	■
Levee	□
Bank Sta	●

Studio Scandicci Torrenti Greve-Vingone
River = Fosso Rigone Reach = Rigone 03 RS = 53.5 BR

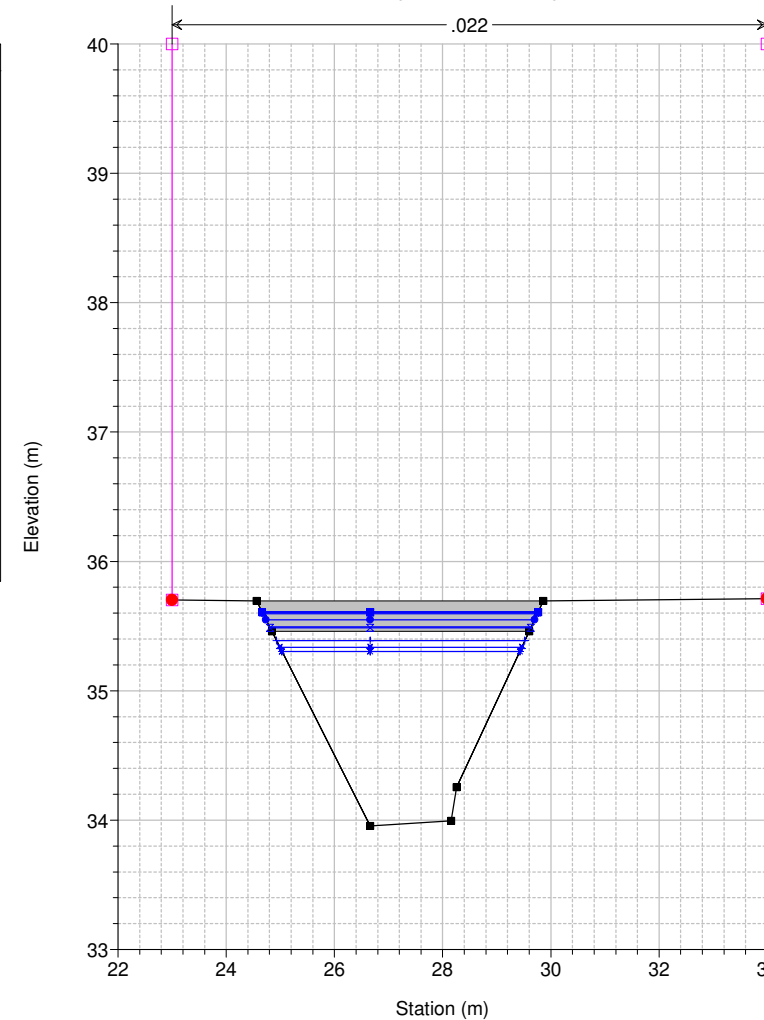

Legend	
WS Max WS - TR030_01_5	▼
WS Max WS - TR030_06_0	■
WS Max WS - TR030_03_0	×
WS Max WS - TR030_01_0	▲
WS Max WS - TR030_09_0	●
WS Max WS - TR030_00_5	+
WS Max WS - TR030_12_0	×
WS Max WS - TR030_18_0	+
WS Max WS - TR030_24_0	+
WS Max WS - TR030_36_0	+
Ground	■
Levee	□
Bank Sta	●

Studio Scandicci Torrenti Greve-Vingone
River = Fosso Rigone Reach = Rigone 03 RS = 53 RI0006_C

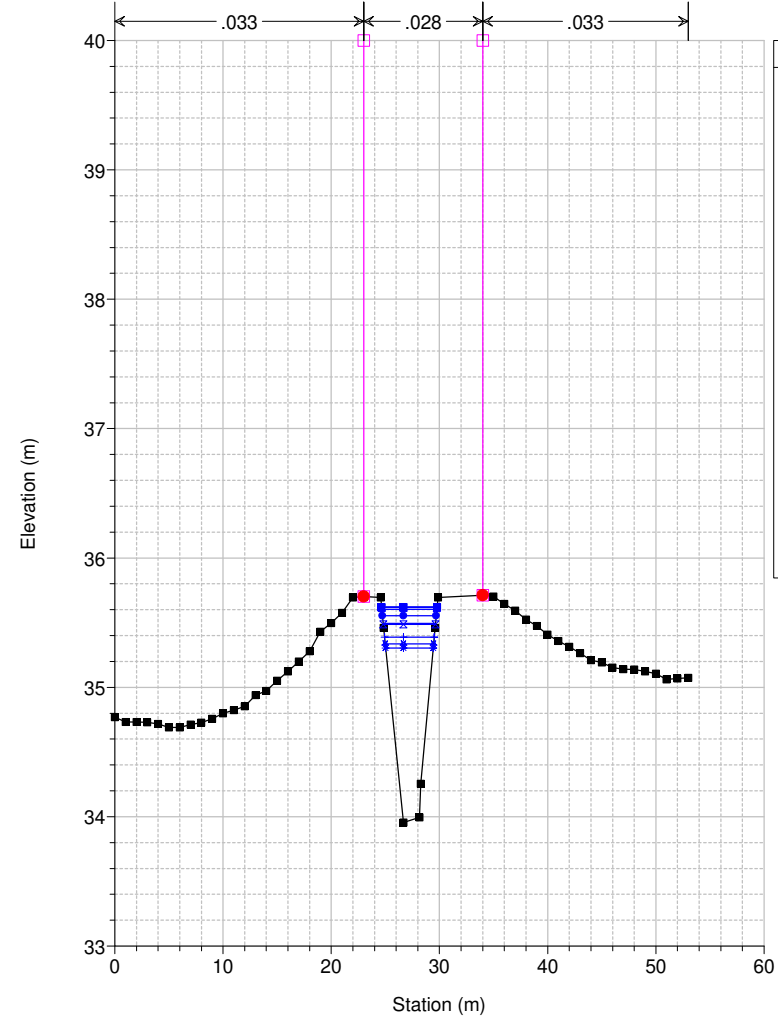

Legend	
WS Max WS - TR030_06_0	■
WS Max WS - TR030_01_5	▼
WS Max WS - TR030_03_0	×
WS Max WS - TR030_01_0	▲
WS Max WS - TR030_09_0	●
WS Max WS - TR030_00_5	+
WS Max WS - TR030_12_0	*
WS Max WS - TR030_18_0	+
WS Max WS - TR030_24_0	+
WS Max WS - TR030_36_0	+
Ground	■
Levee	□
Bank Sta	●

Studio Scandicci Torrenti Greve-Vingone
River = Fosso Rigone Reach = Rigone 03 RS = 52 RI0006_D

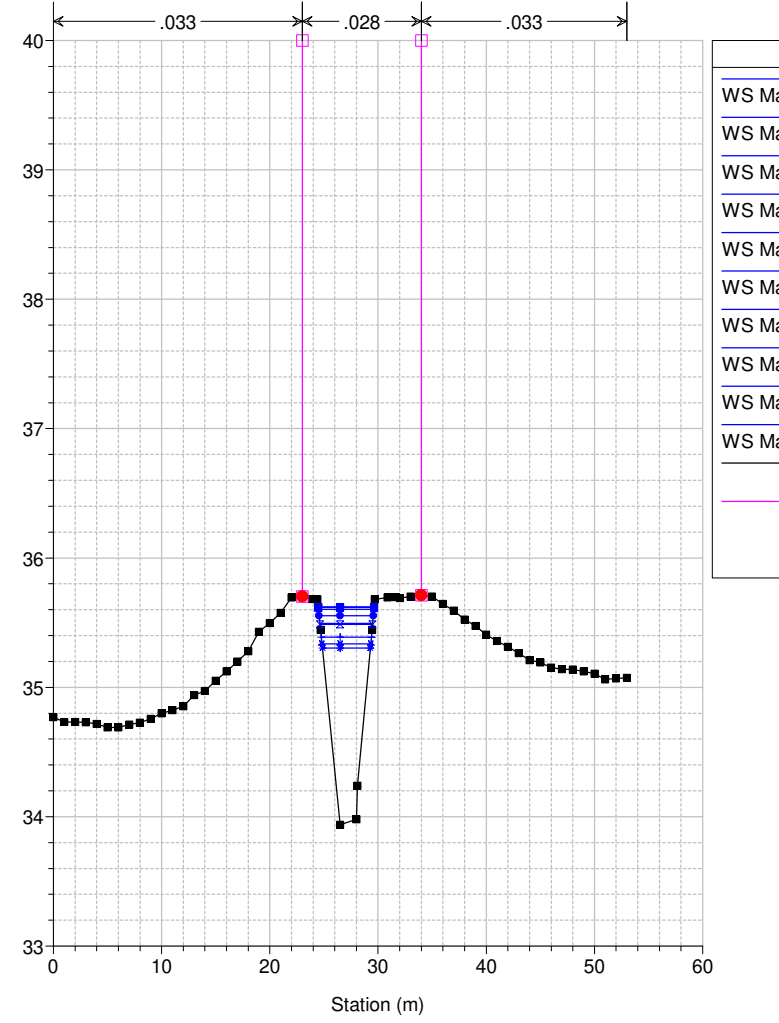

Legend	
WS Max WS - TR030_06_0	■
WS Max WS - TR030_01_5	▼
WS Max WS - TR030_03_0	×
WS Max WS - TR030_01_0	▲
WS Max WS - TR030_09_0	●
WS Max WS - TR030_00_5	+
WS Max WS - TR030_12_0	*
WS Max WS - TR030_18_0	+
WS Max WS - TR030_24_0	+
WS Max WS - TR030_36_0	+
Ground	■
Levee	□
Bank Sta	●

Studio Scandicci Torrenti Greve-Vingone
River = Fosso Rigone Reach = Rigone 03 RS = 51 RI0007_A

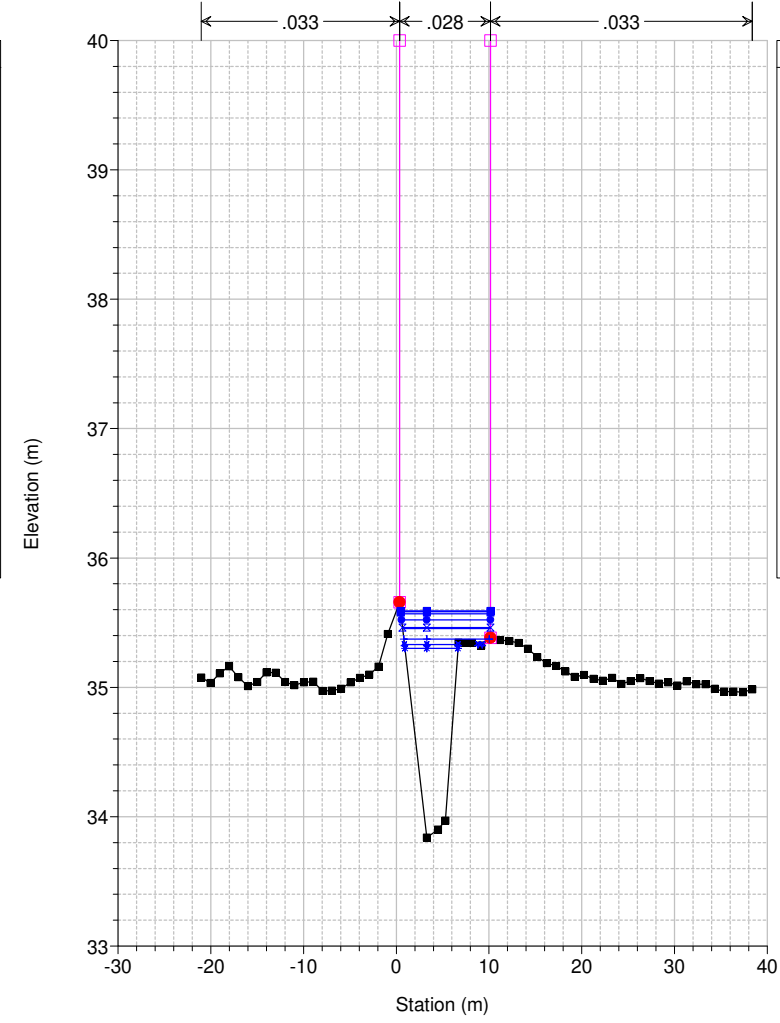

Legend	
WS Max WS - TR030_06_0	■
WS Max WS - TR030_03_0	×
WS Max WS - TR030_01_5	▼
WS Max WS - TR030_01_0	▲
WS Max WS - TR030_09_0	●
WS Max WS - TR030_00_5	+
WS Max WS - TR030_12_0	*
WS Max WS - TR030_18_0	+
WS Max WS - TR030_24_0	+
WS Max WS - TR030_36_0	+
Ground	■
Levee	□
Bank Sta	●

Studio Scandicci Torrenti Greve-Vingone
River = Fosso Rigone Reach = Rigone 03 RS = 50 RI0007_B

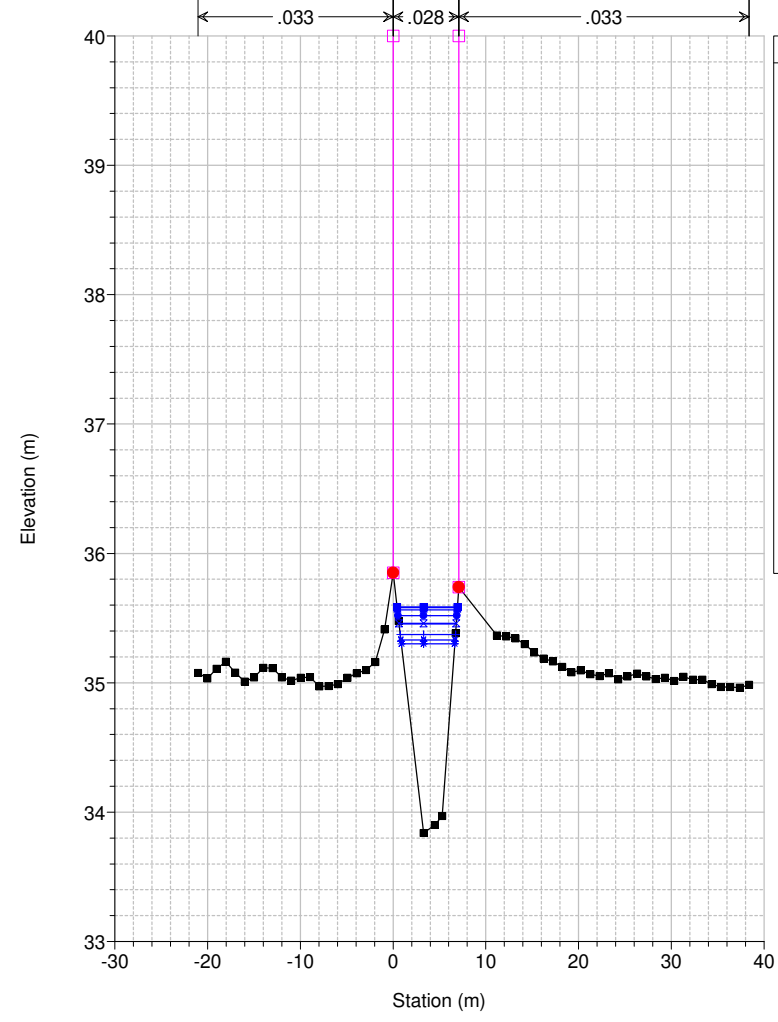

Legend	
WS Max WS - TR030_06_0	■
WS Max WS - TR030_03_0	×
WS Max WS - TR030_01_5	▼
WS Max WS - TR030_01_0	▲
WS Max WS - TR030_09_0	●
WS Max WS - TR030_00_5	+
WS Max WS - TR030_12_0	*
WS Max WS - TR030_18_0	+
WS Max WS - TR030_24_0	+
WS Max WS - TR030_36_0	+
Ground	■
Levee	□
Bank Sta	●

Studio Scandicci Torrenti Greve-Vingone
River = Fosso Rigone Reach = Rigone 03 RS = 49.5 BR

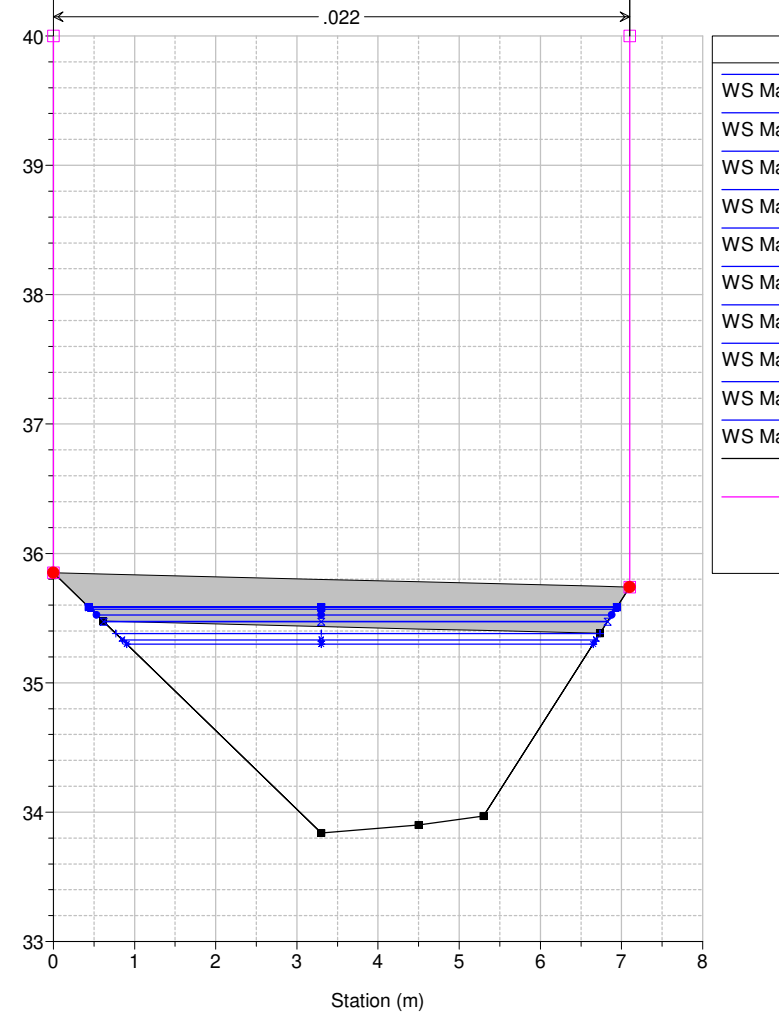

Legend	
WS Max WS - TR030_01_5	▼
WS Max WS - TR030_06_0	■
WS Max WS - TR030_03_0	×
WS Max WS - TR030_01_0	▲
WS Max WS - TR030_09_0	●
WS Max WS - TR030_00_5	+
WS Max WS - TR030_12_0	*
WS Max WS - TR030_18_0	+
WS Max WS - TR030_24_0	+
WS Max WS - TR030_36_0	+
Ground	■
Levee	□
Bank Sta	●

Studio Scandicci Torrenti Greve-Vingone
River = Fosso Rigone Reach = Rigone 03 RS = 49.5 BR

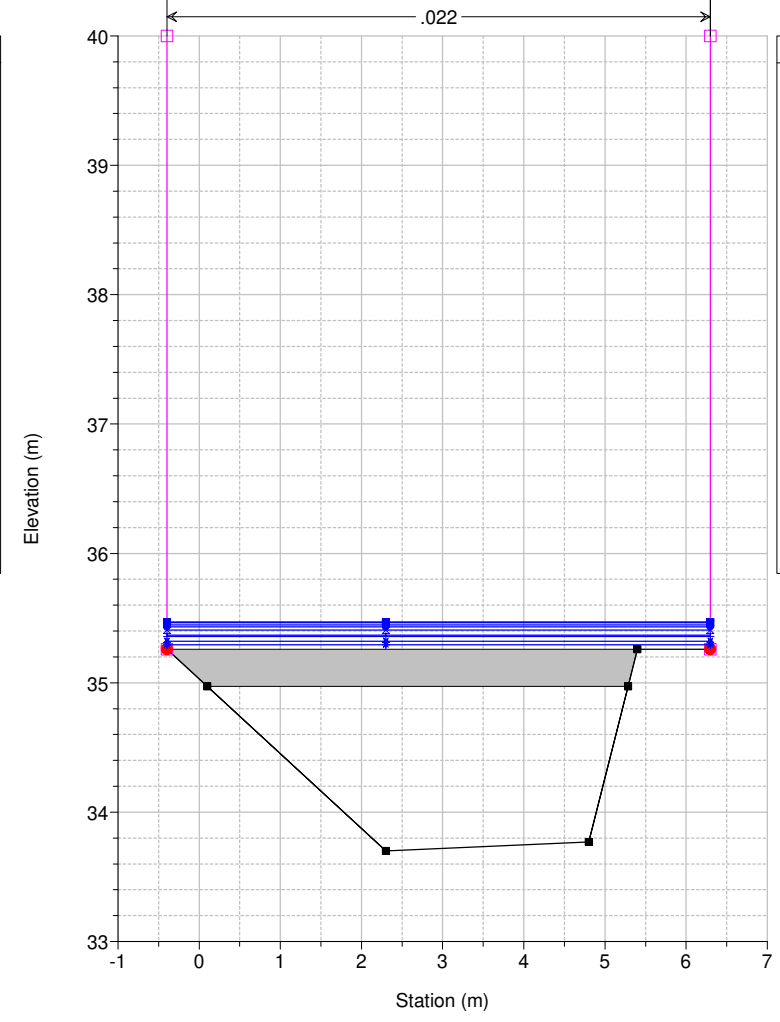

Legend	
WS Max WS - TR030_03_0	×
WS Max WS - TR030_06_0	■
WS Max WS - TR030_01_5	▼
WS Max WS - TR030_01_0	▲
WS Max WS - TR030_09_0	●
WS Max WS - TR030_00_5	+
WS Max WS - TR030_12_0	*
WS Max WS - TR030_18_0	+
WS Max WS - TR030_24_0	+
WS Max WS - TR030_36_0	+
Ground	■
Levee	□
Bank Sta	●

Studio Scandicci Torrenti Greve-Vingone
River = Fosso Rigone Reach = Rigone 03 RS = 49 RI0008_C

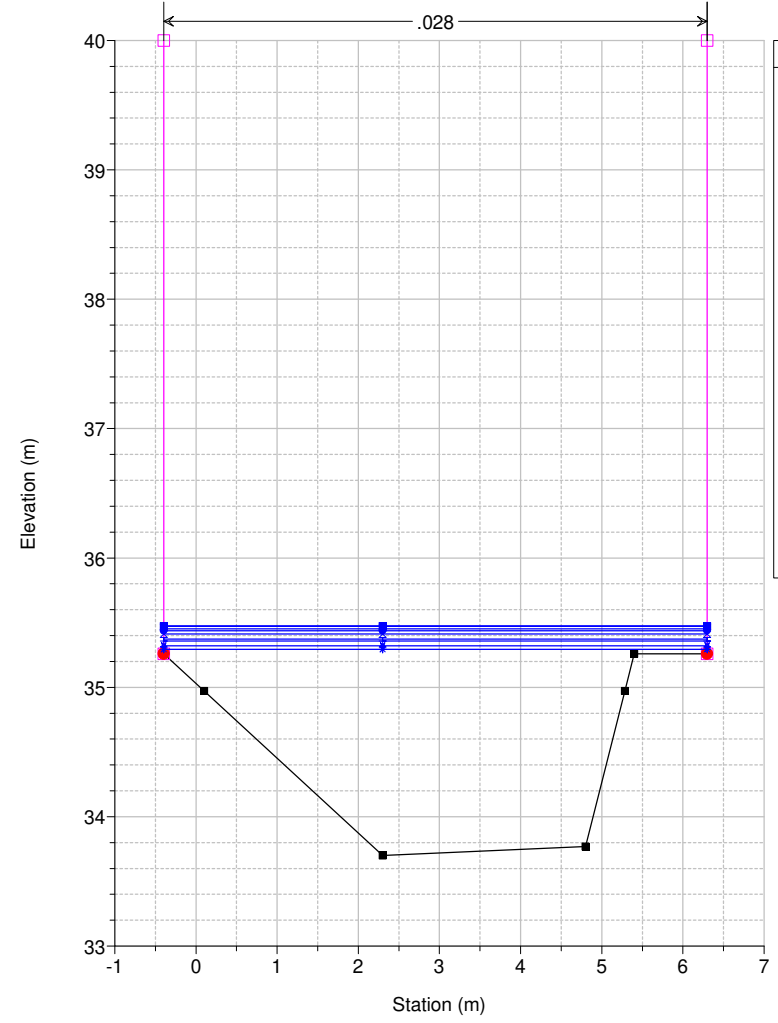

Legend	
WS Max WS - TR030_03_0	x
WS Max WS - TR030_06_0	■
WS Max WS - TR030_01_5	▼
WS Max WS - TR030_01_0	▲
WS Max WS - TR030_09_0	●
WS Max WS - TR030_12_0	×
WS Max WS - TR030_00_5	+
WS Max WS - TR030_18_0	+
WS Max WS - TR030_24_0	+
WS Max WS - TR030_36_0	+
Ground	■
Levee	□
Bank Sta	●

Studio Scandicci Torrenti Greve-Vingone
River = Fosso Rigone Reach = Rigone 03 RS = 48 RI0008_D



Legend	
WS Max WS - TR030_03_0	x
WS Max WS - TR030_06_0	■
WS Max WS - TR030_01_5	▼
WS Max WS - TR030_01_0	▲
WS Max WS - TR030_09_0	●
WS Max WS - TR030_12_0	×
WS Max WS - TR030_00_5	+
WS Max WS - TR030_18_0	+
WS Max WS - TR030_24_0	+
WS Max WS - TR030_36_0	+
Ground	■
Levee	□
Bank Sta	●

Studio Scandicci Torrenti Greve-Vingone
River = Fosso Rigone Reach = Rigone 03 RS = 47 RI0009__

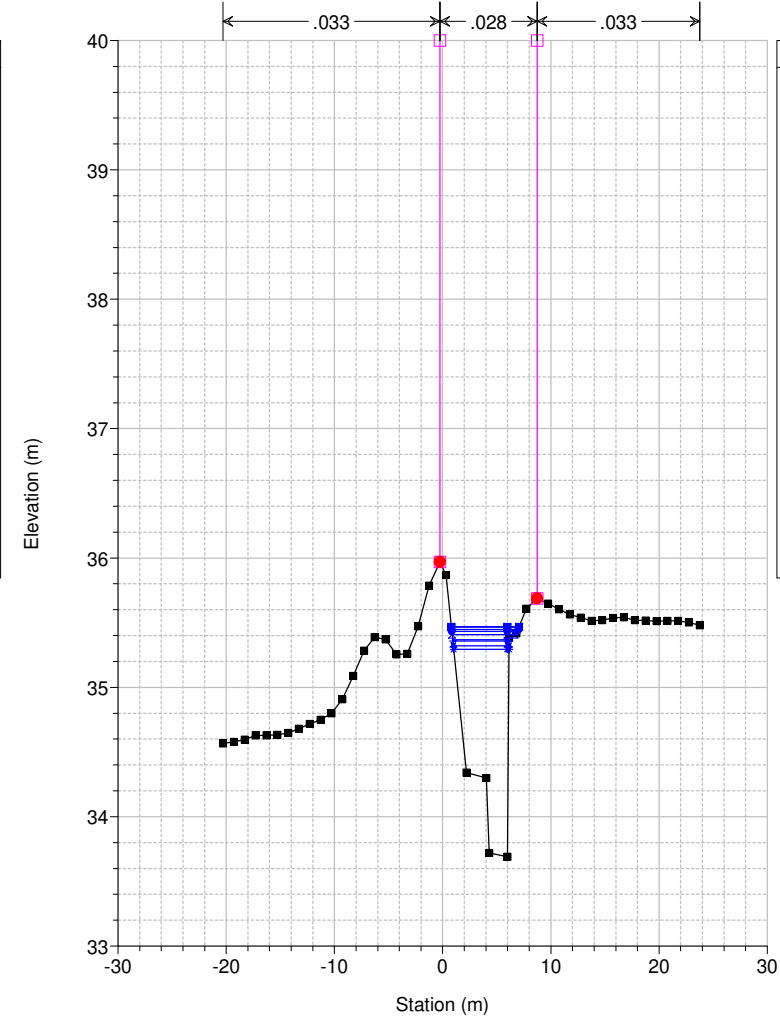

Legend	
WS Max WS - TR030_03_0	x
WS Max WS - TR030_06_0	■
WS Max WS - TR030_01_5	▼
WS Max WS - TR030_01_0	▲
WS Max WS - TR030_09_0	●
WS Max WS - TR030_12_0	×
WS Max WS - TR030_00_5	+
WS Max WS - TR030_18_0	+
WS Max WS - TR030_24_0	+
WS Max WS - TR030_36_0	+
Ground	■
Levee	□
Bank Sta	●

Studio Scandicci Torrenti Greve-Vingone
River = Fosso Rigone Reach = Rigone 03 RS = 46 RI0010__

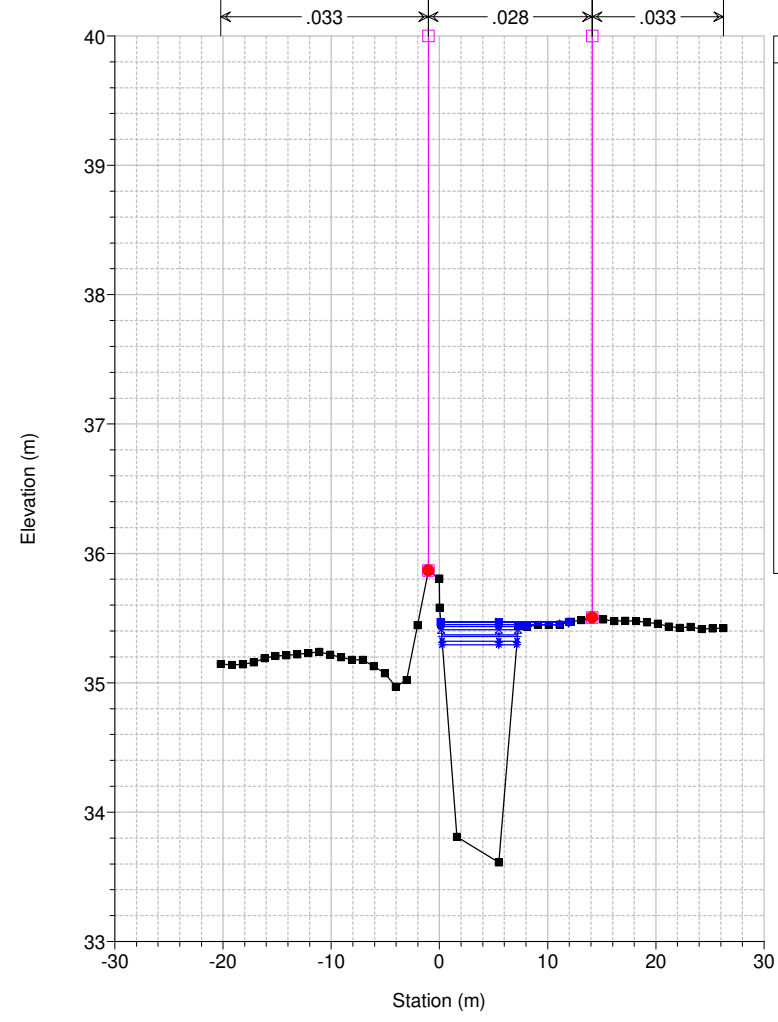

Legend	
WS Max WS - TR030_03_0	x
WS Max WS - TR030_06_0	■
WS Max WS - TR030_01_5	▼
WS Max WS - TR030_01_0	▲
WS Max WS - TR030_09_0	●
WS Max WS - TR030_12_0	×
WS Max WS - TR030_00_5	+
WS Max WS - TR030_18_0	+
WS Max WS - TR030_24_0	+
WS Max WS - TR030_36_0	+
Ground	■
Levee	□
Bank Sta	●

Studio Scandicci Torrenti Greve-Vingone
River = Fosso Rigone Reach = Rigone 03 RS = 45 RI0011__

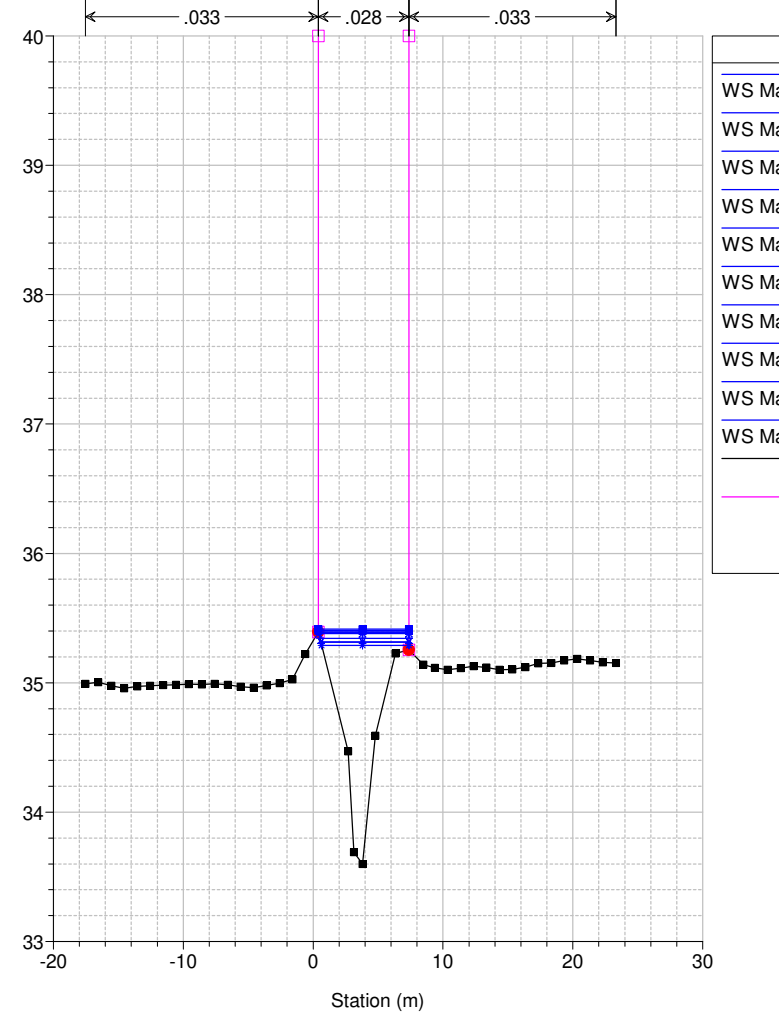

Legend	
WS Max WS - TR030_06_0	■
WS Max WS - TR030_03_0	x
WS Max WS - TR030_01_5	▼
WS Max WS - TR030_09_0	●
WS Max WS - TR030_01_0	▲
WS Max WS - TR030_12_0	×
WS Max WS - TR030_18_0	+
WS Max WS - TR030_00_5	+
WS Max WS - TR030_24_0	+
WS Max WS - TR030_36_0	+
Ground	■
Levee	□
Bank Sta	●

Studio Scandicci Torrenti Greve-Vingone
River = Fosso Rigone Reach = Rigone 03 RS = 44 RI1011_A

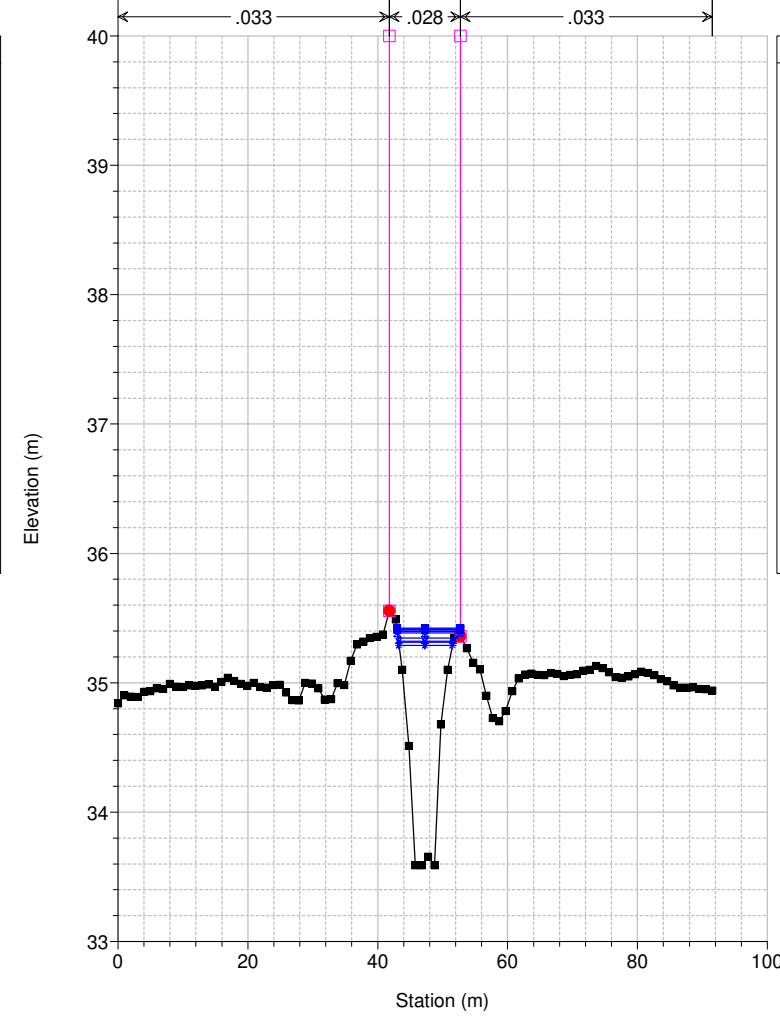

Legend	
WS Max WS - TR030_06_0	■
WS Max WS - TR030_03_0	x
WS Max WS - TR030_01_5	▼
WS Max WS - TR030_09_0	●
WS Max WS - TR030_01_0	▲
WS Max WS - TR030_12_0	×
WS Max WS - TR030_18_0	+
WS Max WS - TR030_00_5	+
WS Max WS - TR030_24_0	+
WS Max WS - TR030_36_0	+
Ground	■
Levee	□
Bank Sta	●

Studio Scandicci Torrenti Greve-Vingone
River = Fosso Rigone Reach = Rigone 03 RS = 43 RI1011_B

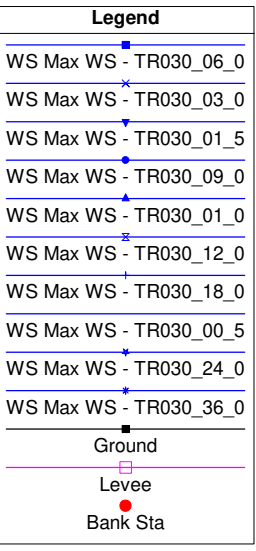
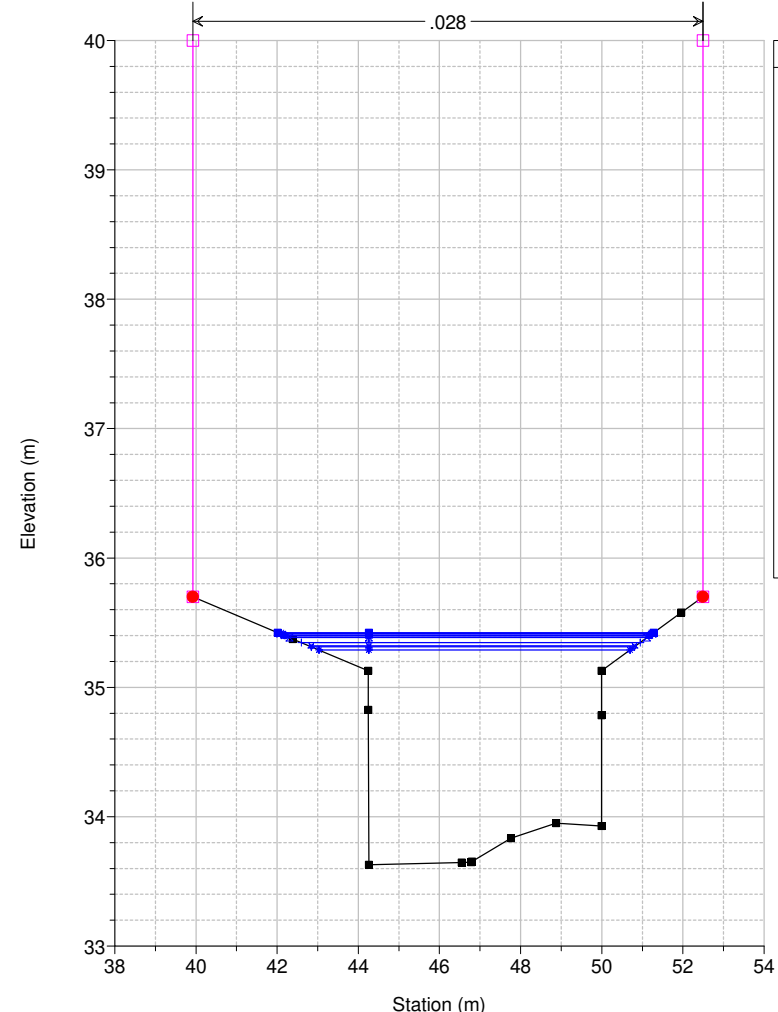

Studio Scandicci Torrenti Greve-Vingone
River = Fosso Rigone Reach = Rigone 03 RS = 42.5 BR

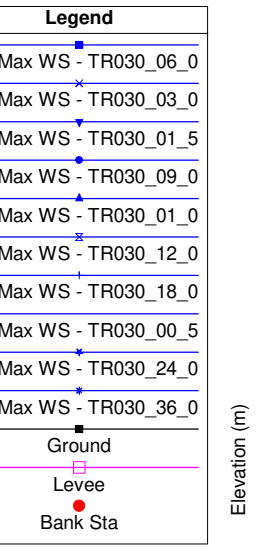
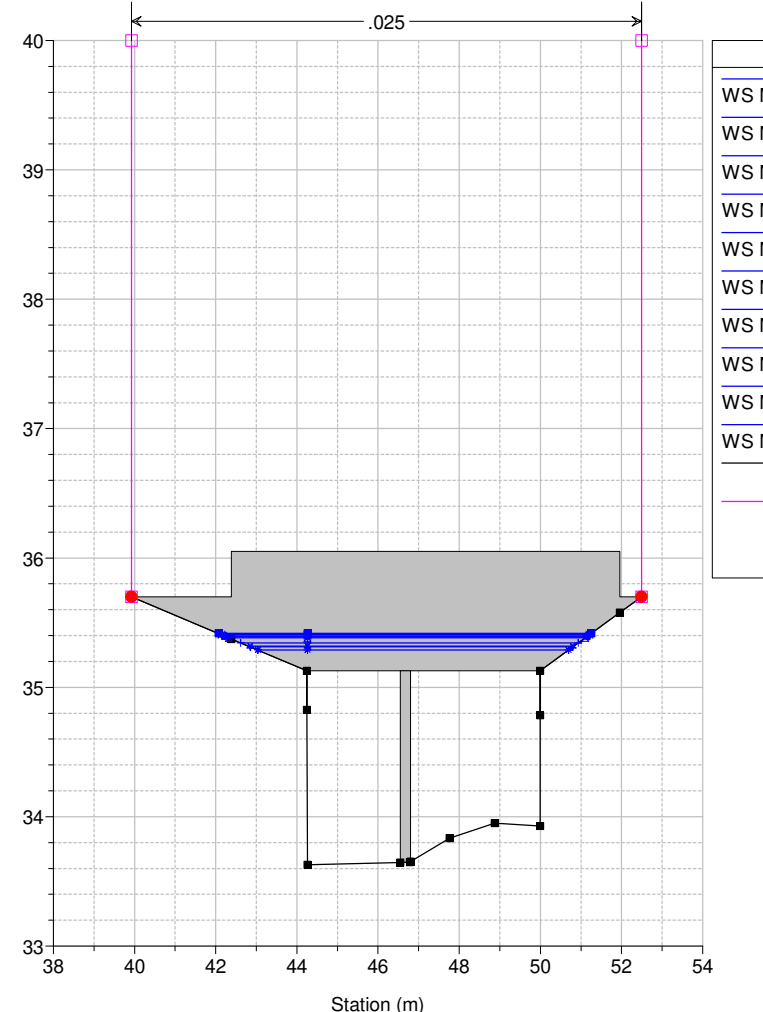

Studio Scandicci Torrenti Greve-Vingone
River = Fosso Rigone Reach = Rigone 03 RS = 42.5 BR

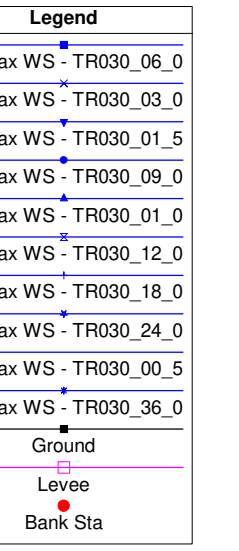
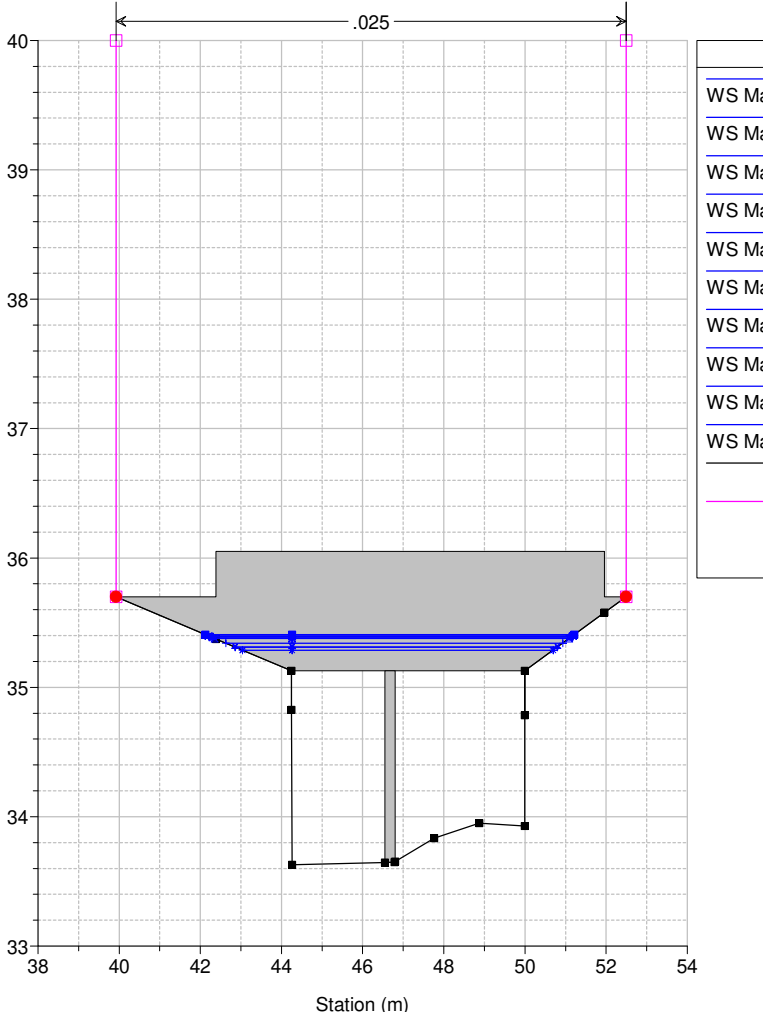

Studio Scandicci Torrenti Greve-Vingone
River = Fosso Rigone Reach = Rigone 03 RS = 42 RI1011_C

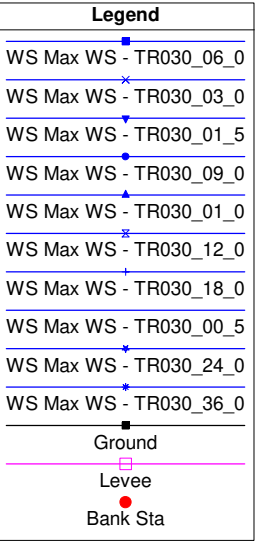
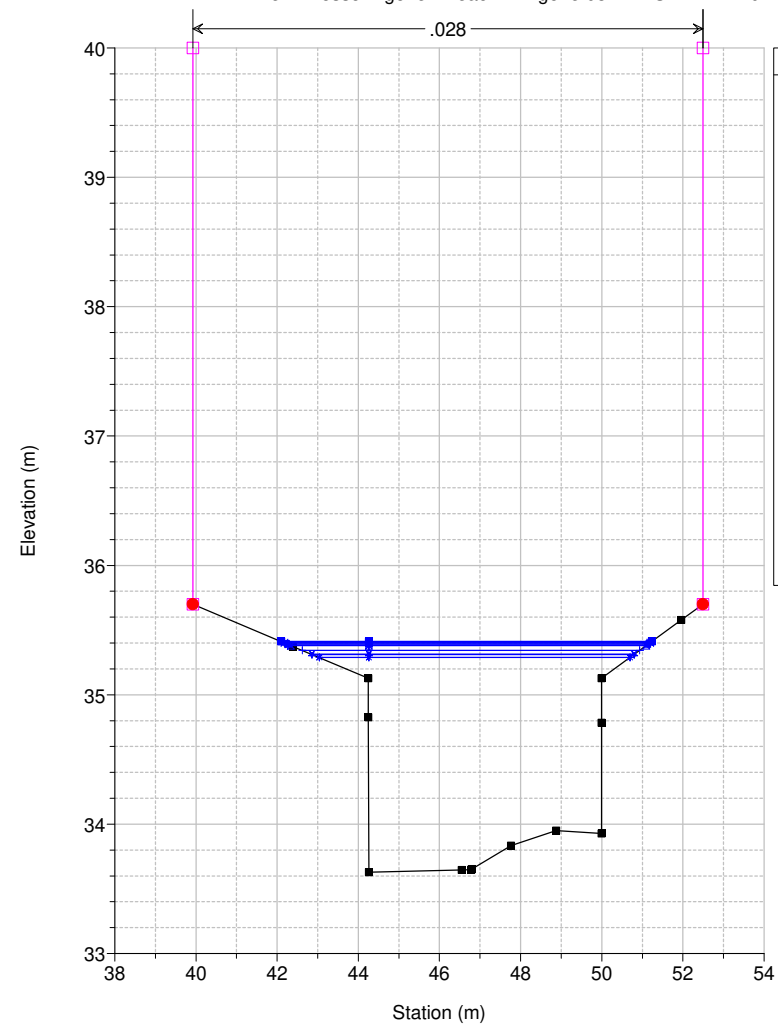

Studio Scandicci Torrenti Greve-Vingone
River = Fosso Rigone Reach = Rigone 03 RS = 41 RI1011_D

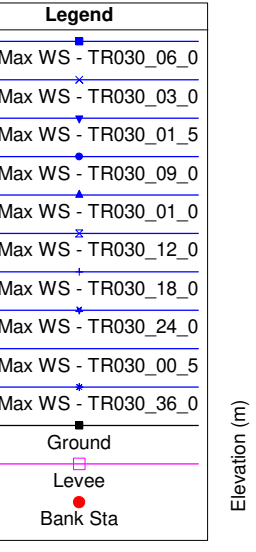
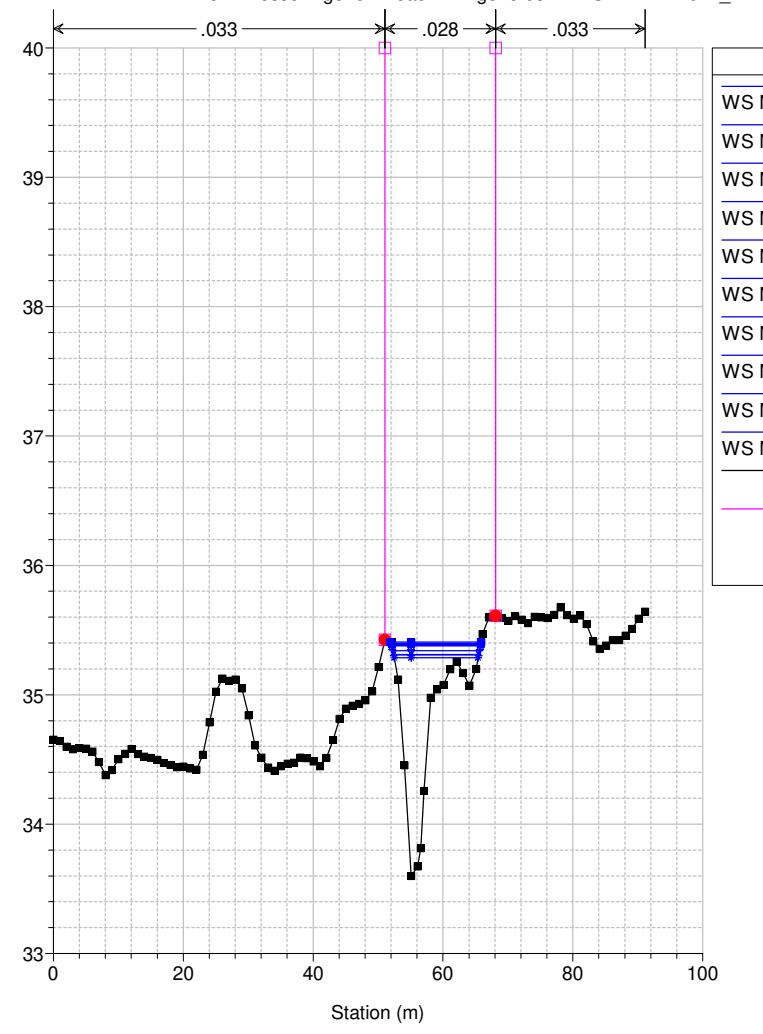

Studio Scandicci Torrenti Greve-Vingone
River = Fosso Rigone Reach = Rigone 03 RS = 40 RI1012_

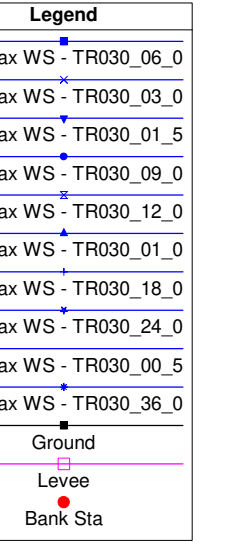
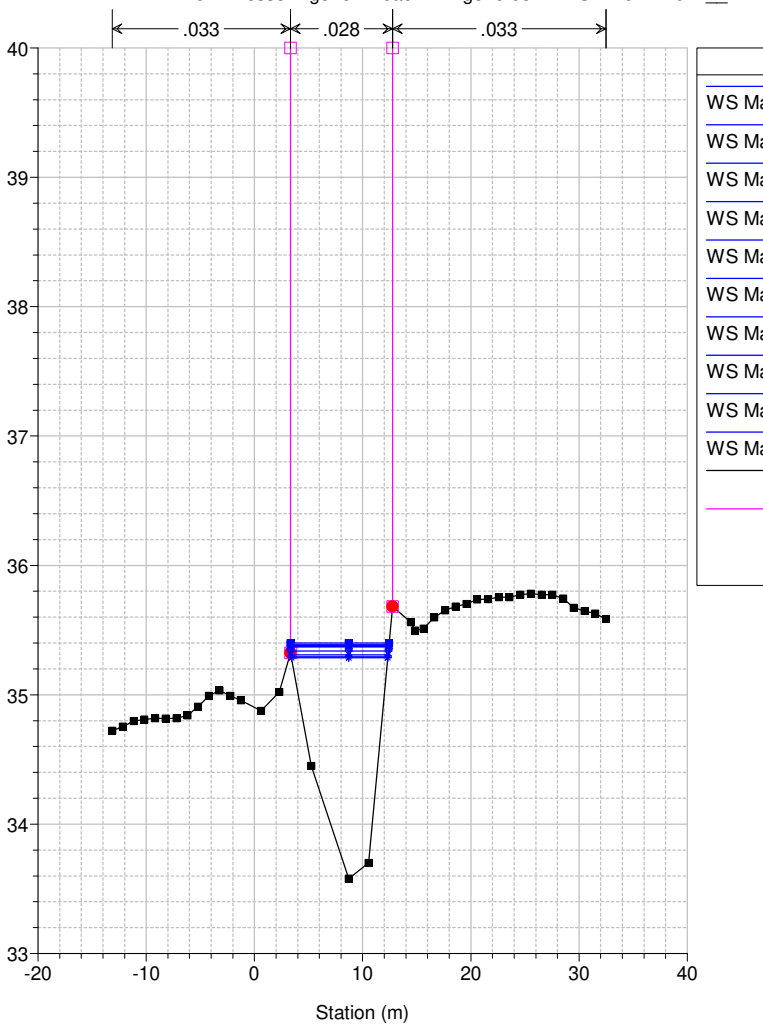

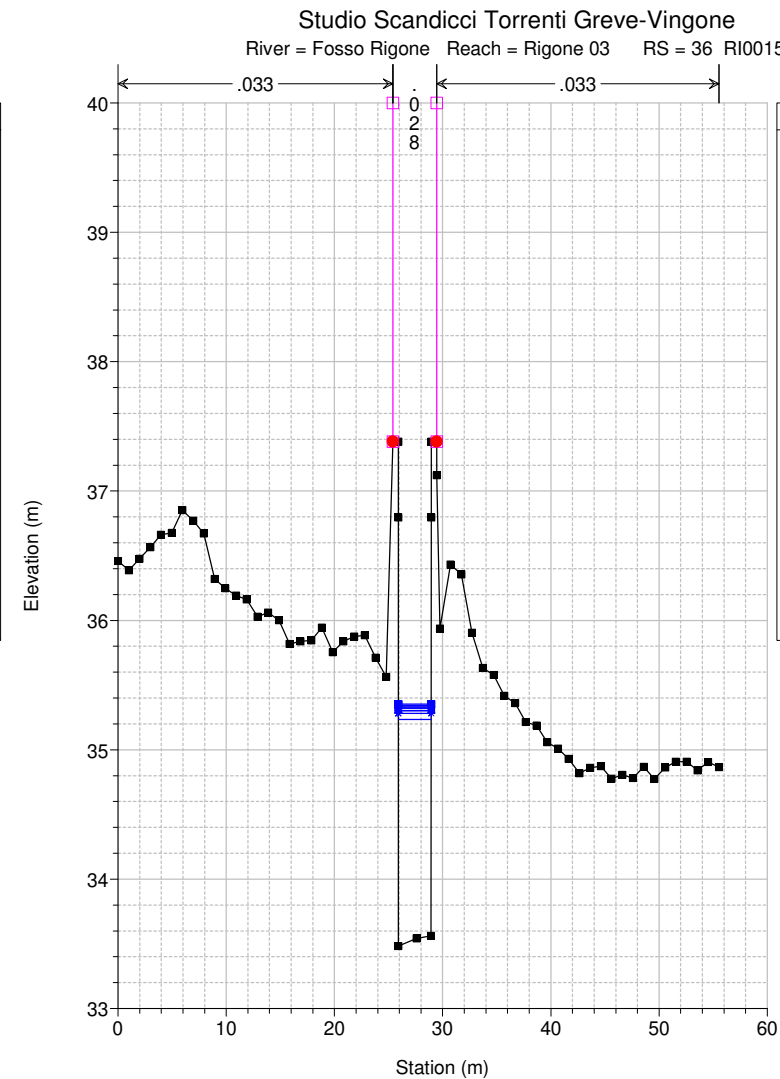
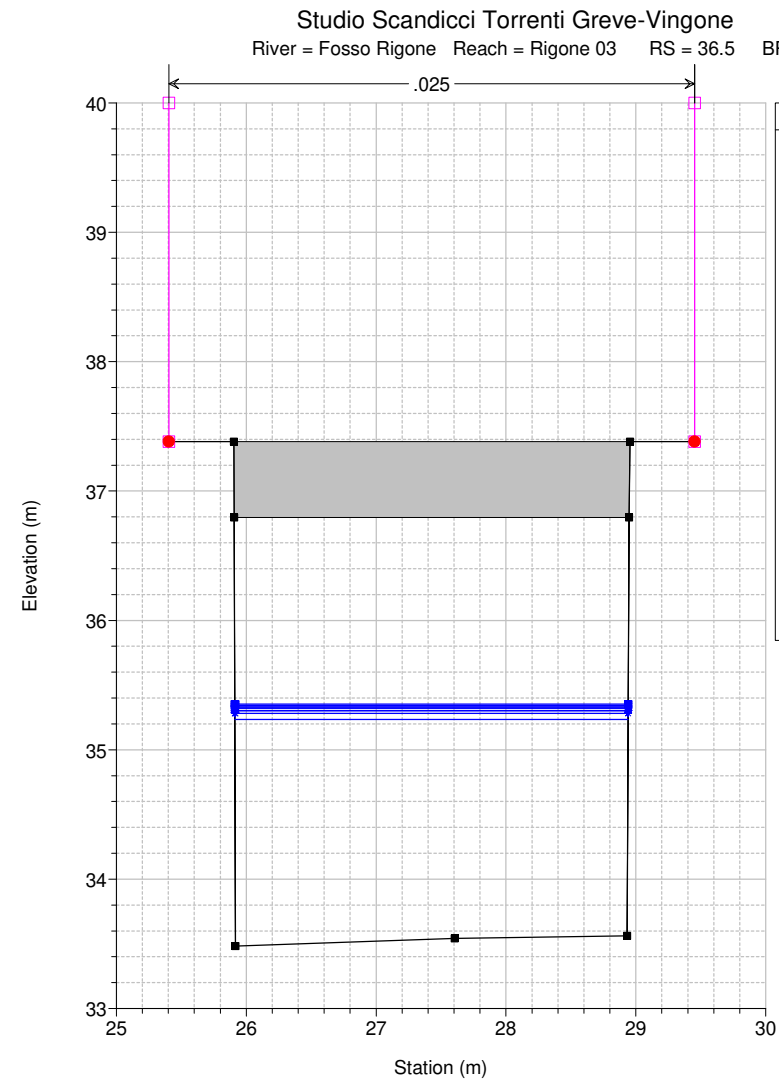
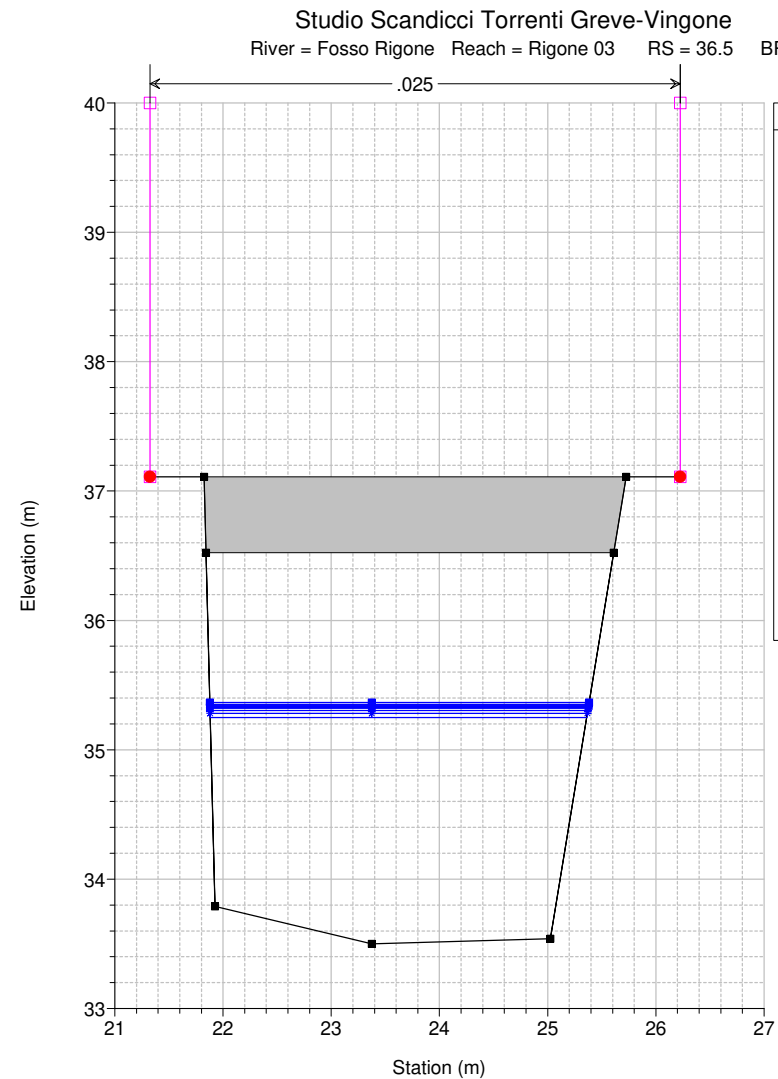
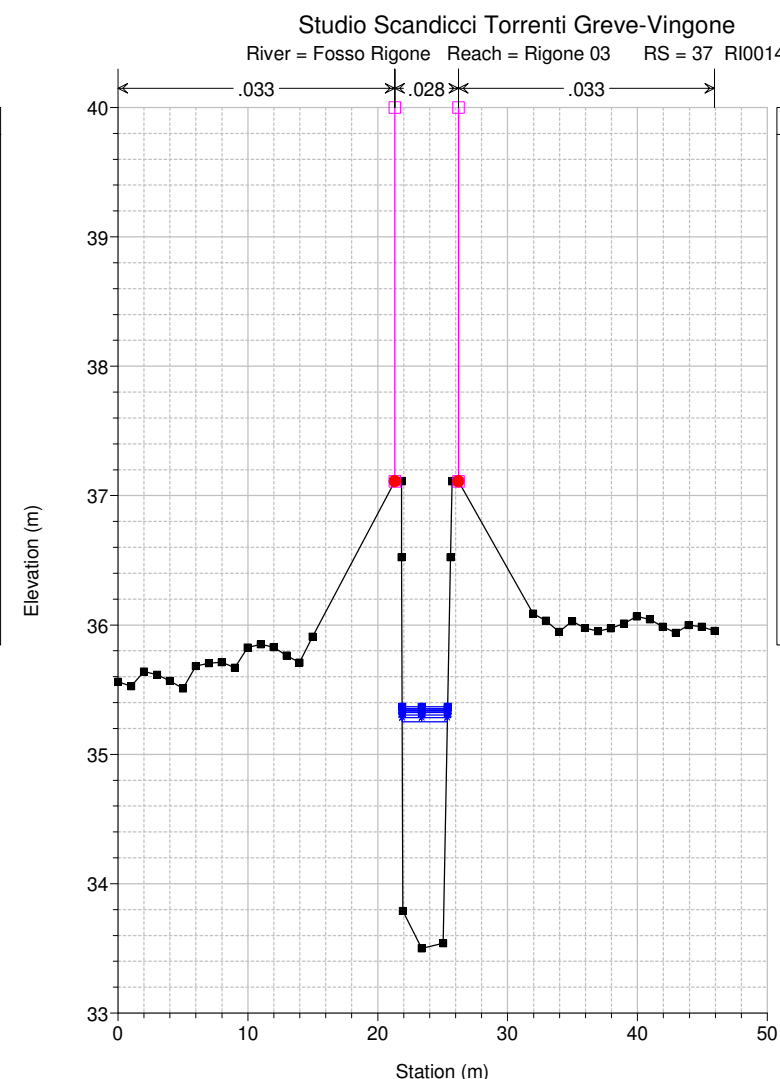
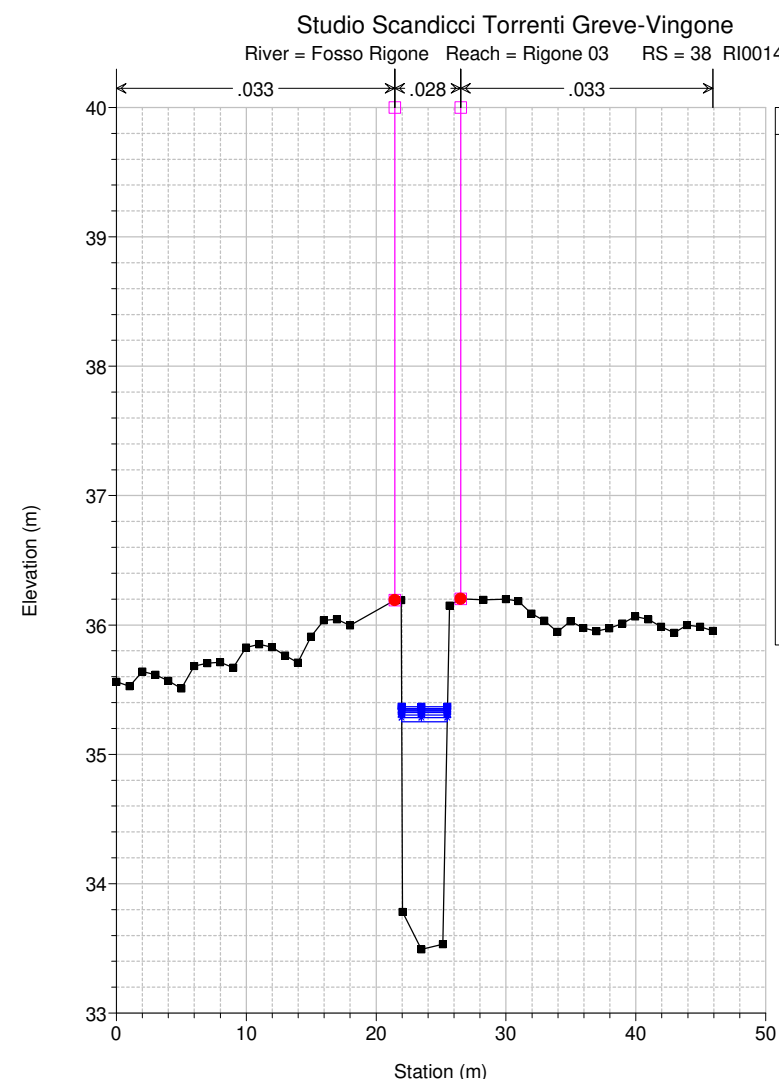
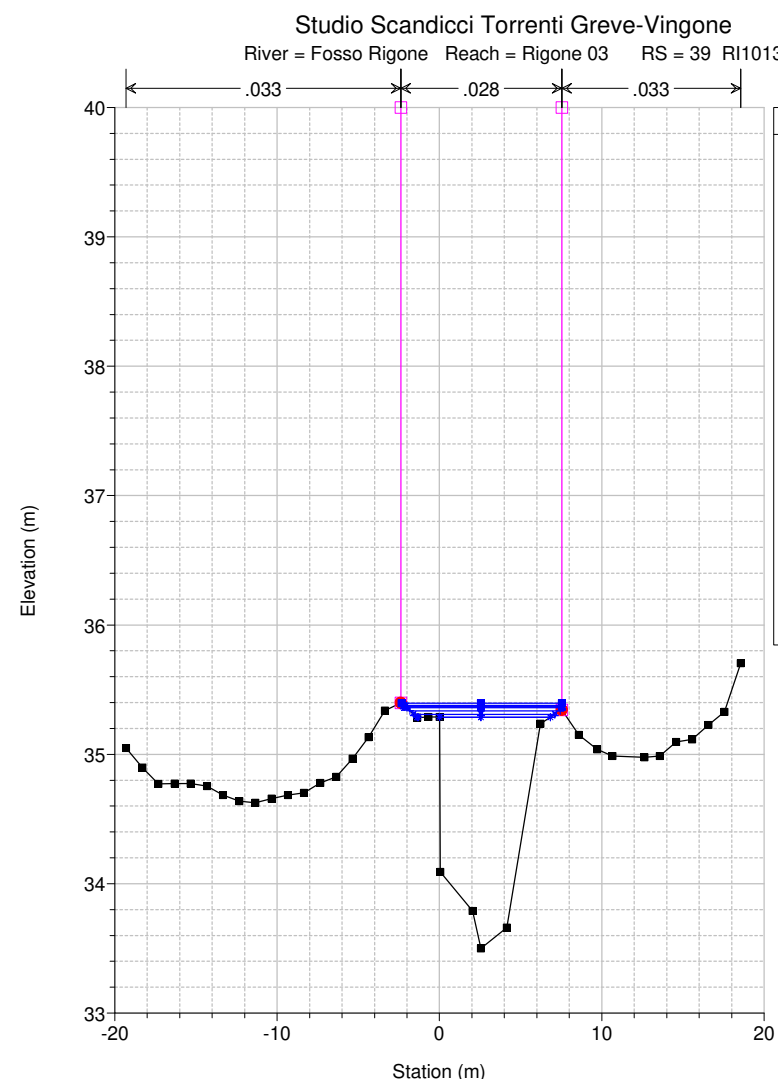

Studio Scandicci Torrenti Greve-Vingone
River = Fosso Rigone Reach = Rigone 03 RS = 35 RI0015_D

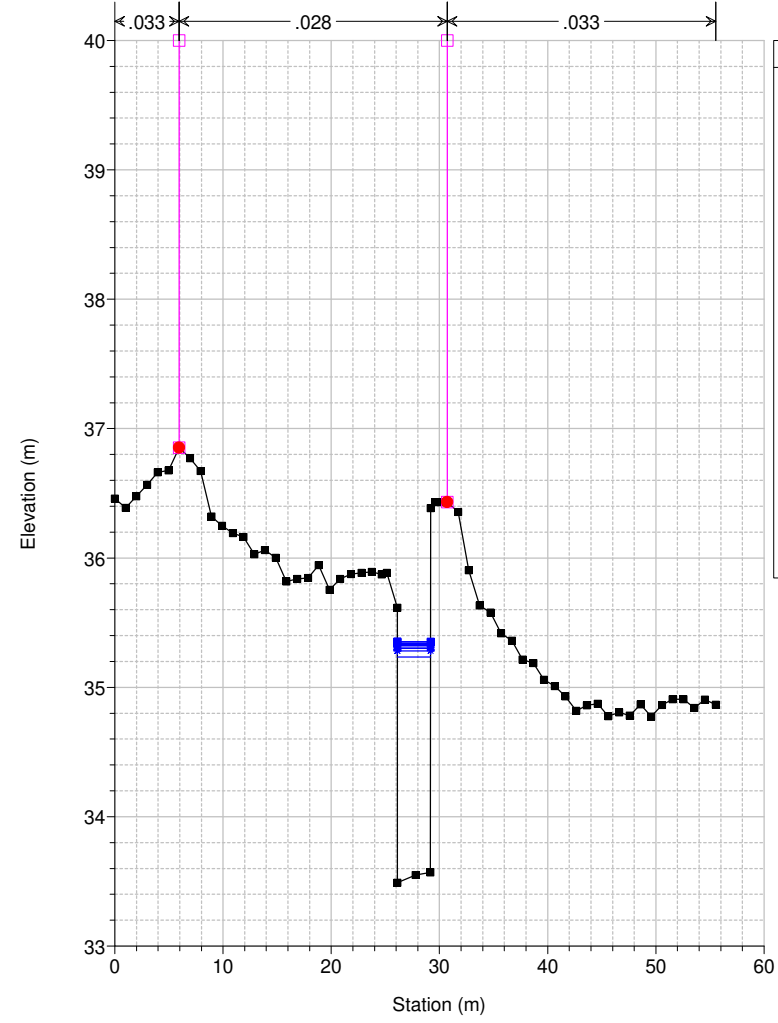

Legend	
WS Max WS - TR030_06_0	■
WS Max WS - TR030_12_0	×
WS Max WS - TR030_09_0	●
WS Max WS - TR030_03_0	×
WS Max WS - TR030_18_0	▼
WS Max WS - TR030_01_5	▲
WS Max WS - TR030_01_0	▼
WS Max WS - TR030_24_0	▲
WS Max WS - TR030_36_0	▲
WS Max WS - TR030_00_5	▲
Ground	■
Levee	□
Bank Sta	●

Studio Scandicci Torrenti Greve-Vingone
River = Fosso Rigone Reach = Rigone 03 RS = 34 RI0016_A

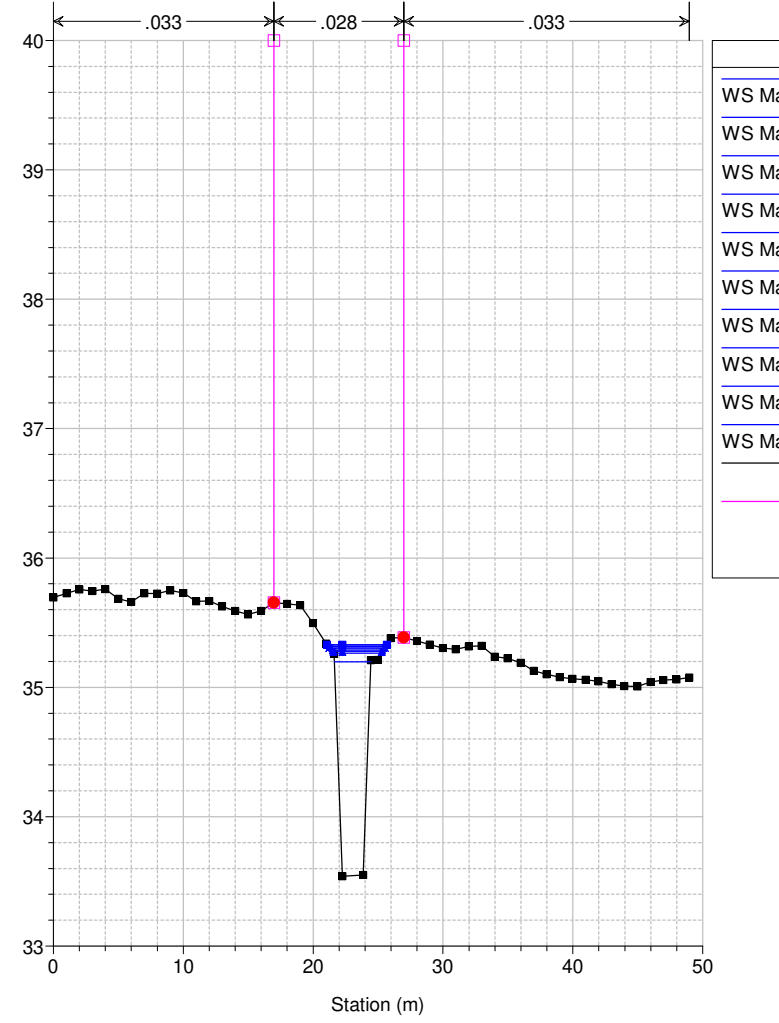

Legend	
WS Max WS - TR030_06_0	■
WS Max WS - TR030_12_0	×
WS Max WS - TR030_09_0	●
WS Max WS - TR030_18_0	▼
WS Max WS - TR030_03_0	×
WS Max WS - TR030_24_0	▲
WS Max WS - TR030_01_5	▲
WS Max WS - TR030_36_0	▲
WS Max WS - TR030_01_0	▲
WS Max WS - TR030_00_5	▲
Ground	■
Levee	□
Bank Sta	●

Studio Scandicci Torrenti Greve-Vingone
River = Fosso Rigone Reach = Rigone 03 RS = 33 RI0016_B

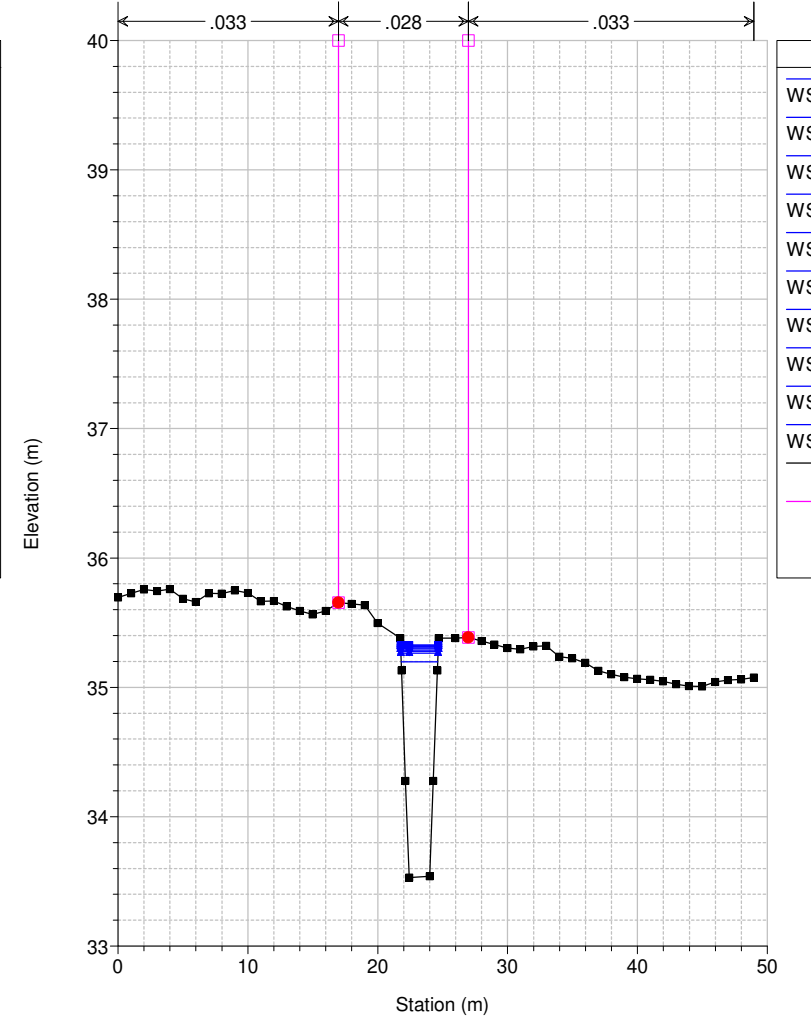

Legend	
WS Max WS - TR030_12_0	×
WS Max WS - TR030_06_0	■
WS Max WS - TR030_18_0	●
WS Max WS - TR030_09_0	▼
WS Max WS - TR030_03_0	×
WS Max WS - TR030_24_0	▲
WS Max WS - TR030_01_5	▲
WS Max WS - TR030_36_0	▲
WS Max WS - TR030_01_0	▲
WS Max WS - TR030_00_5	▲
Ground	■
Levee	□
Bank Sta	●

Studio Scandicci Torrenti Greve-Vingone
River = Fosso Rigone Reach = Rigone 03 RS = 32.5 BR

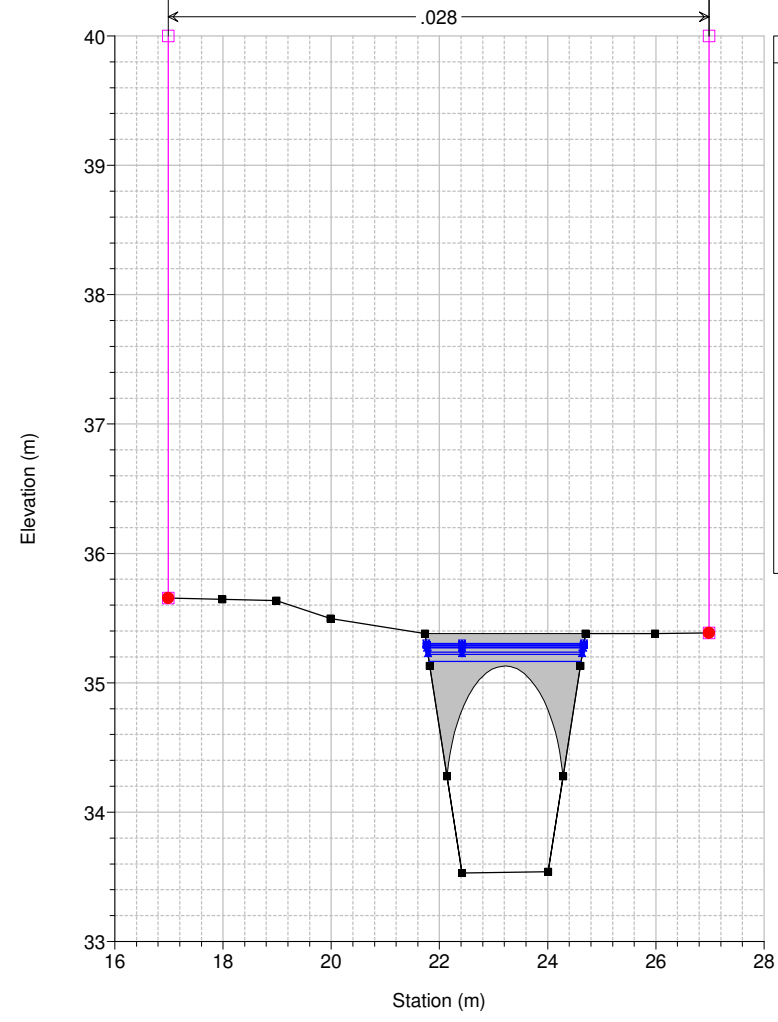

Legend	
WS Max WS - TR030_12_0	×
WS Max WS - TR030_18_0	▲
WS Max WS - TR030_06_0	■
WS Max WS - TR030_24_0	▼
WS Max WS - TR030_09_0	●
WS Max WS - TR030_36_0	▲
WS Max WS - TR030_03_0	×
WS Max WS - TR030_01_5	▲
WS Max WS - TR030_01_0	▲
WS Max WS - TR030_00_5	▲
Ground	■
Levee	□
Bank Sta	●

Studio Scandicci Torrenti Greve-Vingone
River = Fosso Rigone Reach = Rigone 03 RS = 32.5 BR

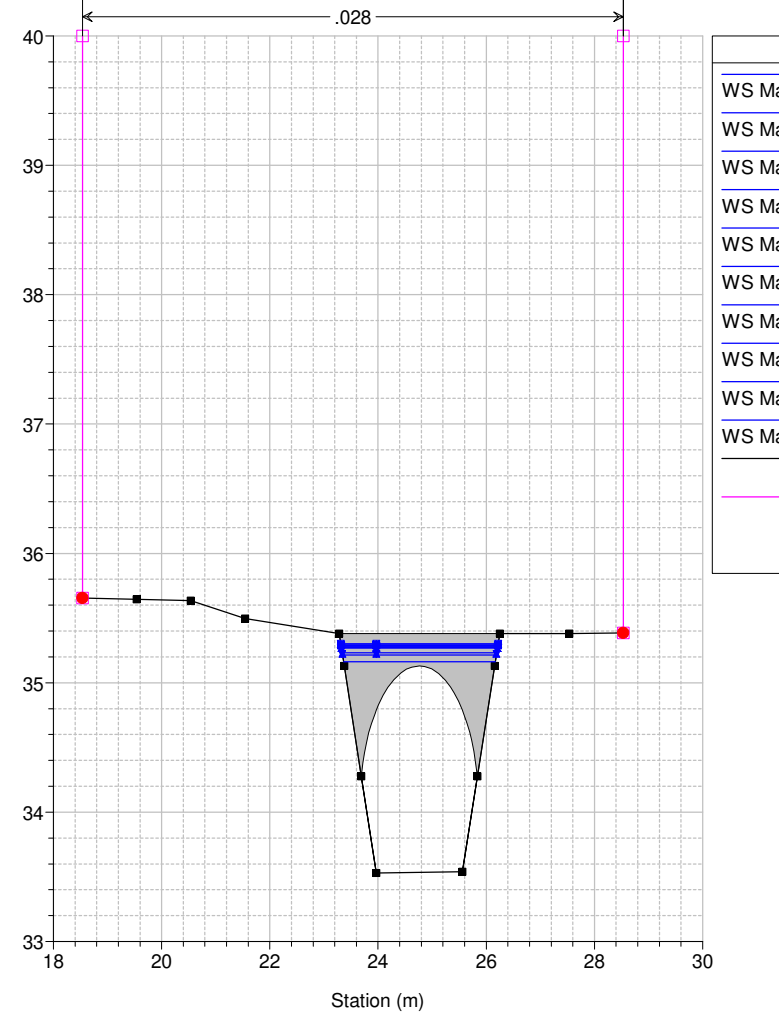

Legend	
WS Max WS - TR030_12_0	×
WS Max WS - TR030_18_0	▲
WS Max WS - TR030_06_0	■
WS Max WS - TR030_24_0	▼
WS Max WS - TR030_09_0	●
WS Max WS - TR030_36_0	▲
WS Max WS - TR030_03_0	×
WS Max WS - TR030_01_5	▲
WS Max WS - TR030_01_0	▲
WS Max WS - TR030_00_5	▲
Ground	■
Levee	□
Bank Sta	●

Studio Scandicci Torrenti Greve-Vingone
River = Fosso Rigone Reach = Rigone 03 RS = 32 RI0016_C

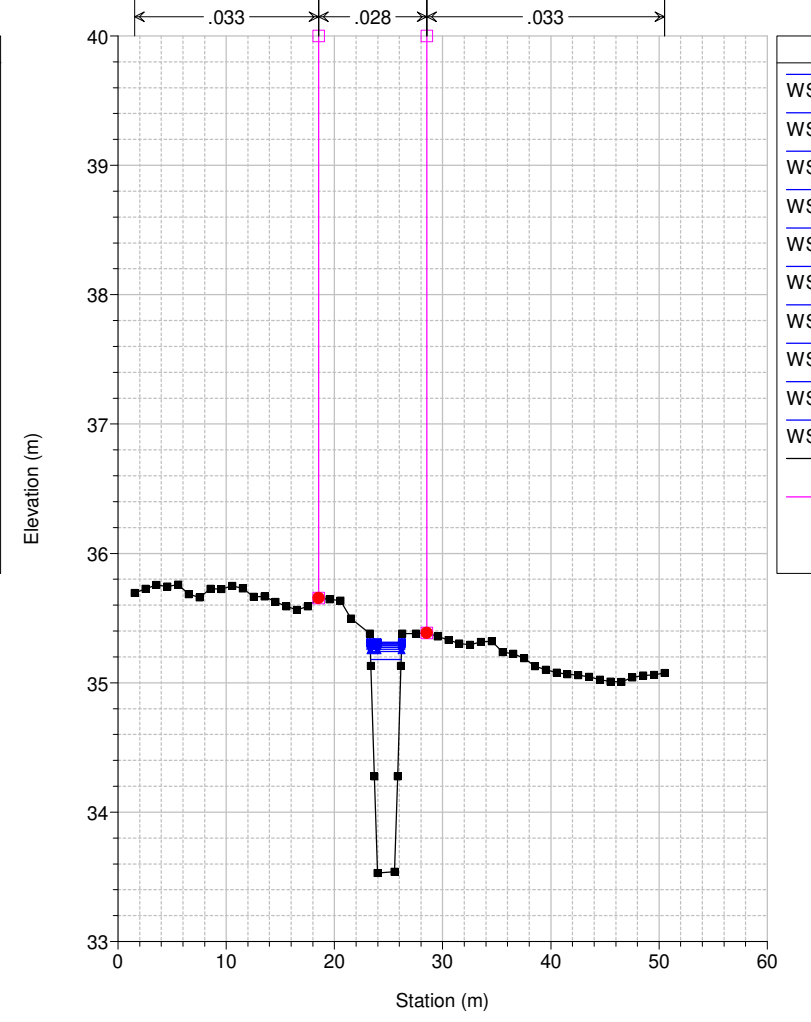

Legend	
WS Max WS - TR030_12_0	×
WS Max WS - TR030_06_0	■
WS Max WS - TR030_18_0	●
WS Max WS - TR030_09_0	▼
WS Max WS - TR030_24_0	▲
WS Max WS - TR030_03_0	×
WS Max WS - TR030_36_0	▲
WS Max WS - TR030_01_5	▲
WS Max WS - TR030_01_0	▲
WS Max WS - TR030_00_5	▲
Ground	■
Levee	□
Bank Sta	●

Studio Scandicci Torrenti Greve-Vingone
River = Fosso Rigone Reach = Rigone 03 RS = 31 RI0016_D

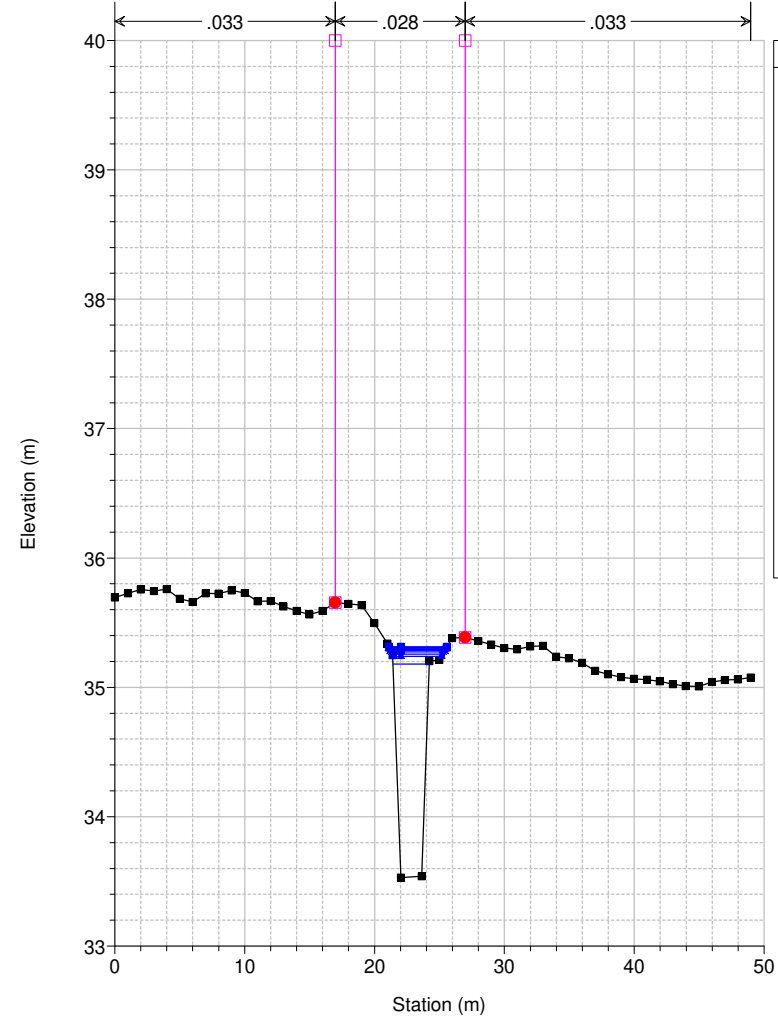

Legend	
WS Max WS - TR030_12_0	✕
WS Max WS - TR030_06_0	■
WS Max WS - TR030_18_0	+
WS Max WS - TR030_09_0	●
WS Max WS - TR030_24_0	▼
WS Max WS - TR030_03_0	✕
WS Max WS - TR030_36_0	+
WS Max WS - TR030_01_5	▼
WS Max WS - TR030_01_0	▲
WS Max WS - TR030_00_5	▲
Ground	■
Levee	□
Bank Sta	●

Studio Scandicci Torrenti Greve-Vingone
River = Fosso Rigone Reach = Rigone 03 RS = 30 RI1016_A

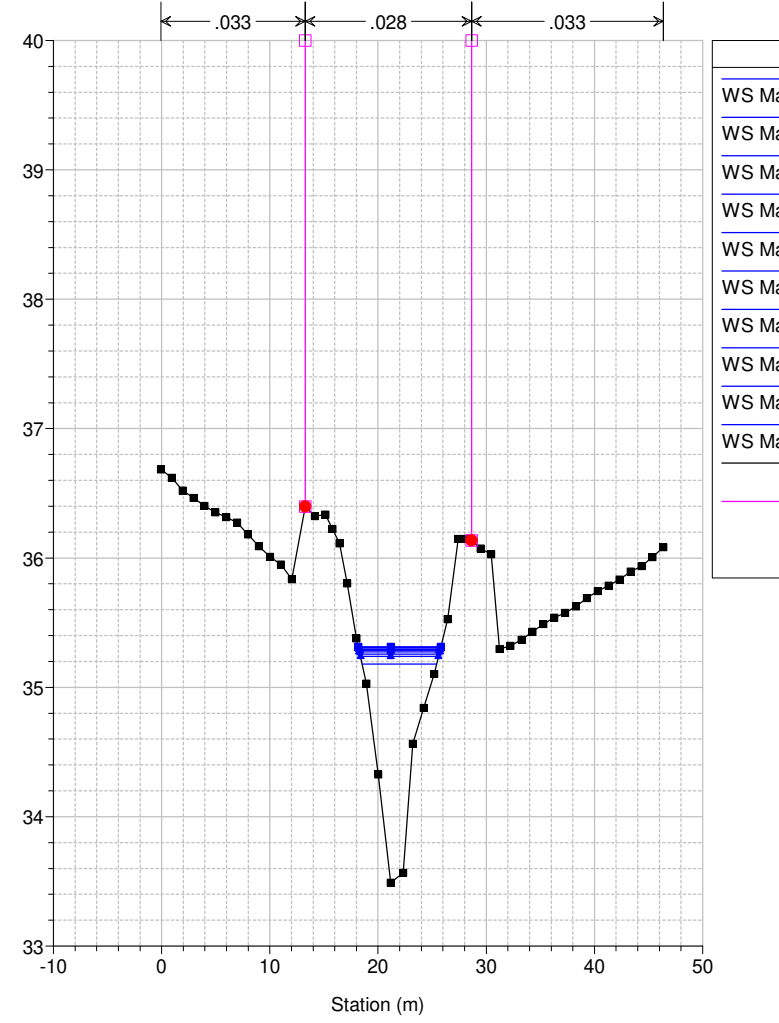

Legend	
WS Max WS - TR030_12_0	✕
WS Max WS - TR030_06_0	■
WS Max WS - TR030_18_0	+
WS Max WS - TR030_09_0	●
WS Max WS - TR030_24_0	▼
WS Max WS - TR030_03_0	✕
WS Max WS - TR030_36_0	+
WS Max WS - TR030_01_5	▼
WS Max WS - TR030_01_0	▲
WS Max WS - TR030_00_5	▲
Ground	■
Levee	□
Bank Sta	●

Studio Scandicci Torrenti Greve-Vingone
River = Fosso Rigone Reach = Rigone 03 RS = 29 RI1016_B

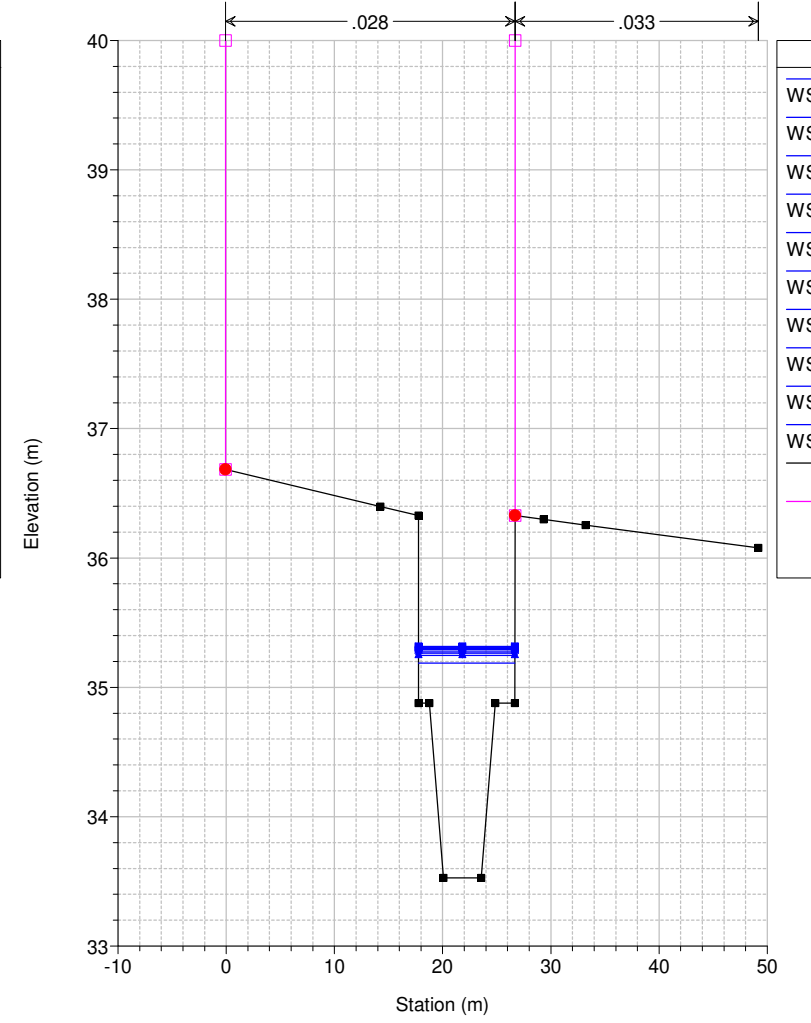

Legend	
WS Max WS - TR030_12_0	✕
WS Max WS - TR030_06_0	■
WS Max WS - TR030_18_0	+
WS Max WS - TR030_09_0	●
WS Max WS - TR030_24_0	▼
WS Max WS - TR030_03_0	✕
WS Max WS - TR030_36_0	+
WS Max WS - TR030_01_5	▼
WS Max WS - TR030_01_0	▲
WS Max WS - TR030_00_5	▲
Ground	■
Levee	□
Bank Sta	●

Studio Scandicci Torrenti Greve-Vingone
River = Fosso Rigone Reach = Rigone 03 RS = 28.5 BR

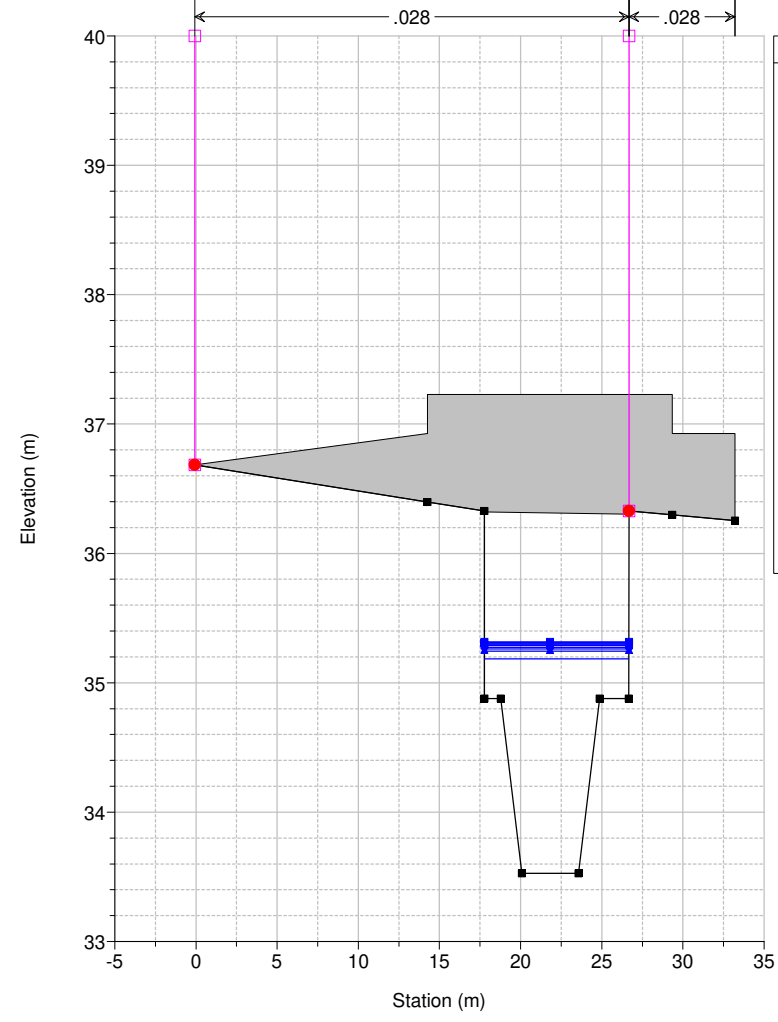

Legend	
WS Max WS - TR030_12_0	✕
WS Max WS - TR030_06_0	■
WS Max WS - TR030_18_0	+
WS Max WS - TR030_09_0	●
WS Max WS - TR030_24_0	▼
WS Max WS - TR030_03_0	✕
WS Max WS - TR030_36_0	+
WS Max WS - TR030_01_5	▼
WS Max WS - TR030_01_0	▲
WS Max WS - TR030_00_5	▲
Ground	■
Levee	□
Bank Sta	●

Studio Scandicci Torrenti Greve-Vingone
River = Fosso Rigone Reach = Rigone 03 RS = 28.5 BR

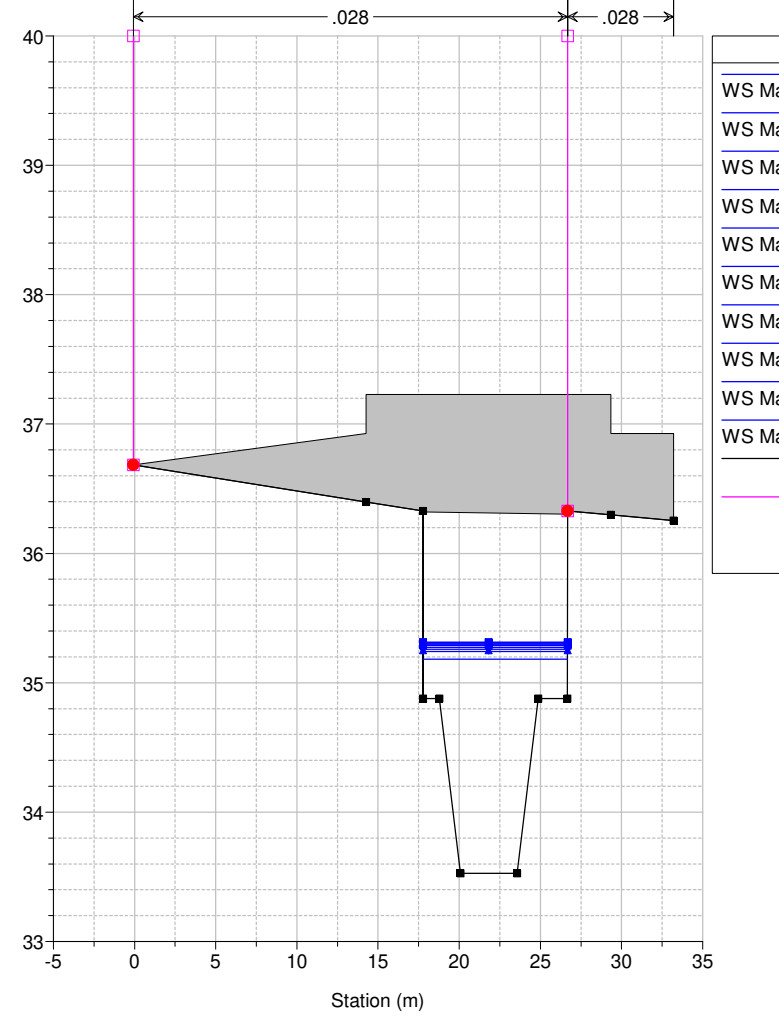

Legend	
WS Max WS - TR030_12_0	✕
WS Max WS - TR030_06_0	■
WS Max WS - TR030_18_0	+
WS Max WS - TR030_09_0	●
WS Max WS - TR030_24_0	▼
WS Max WS - TR030_03_0	✕
WS Max WS - TR030_36_0	+
WS Max WS - TR030_01_5	▼
WS Max WS - TR030_01_0	▲
WS Max WS - TR030_00_5	▲
Ground	■
Levee	□
Bank Sta	●

Studio Scandicci Torrenti Greve-Vingone
River = Fosso Rigone Reach = Rigone 03 RS = 28 RI1016_C

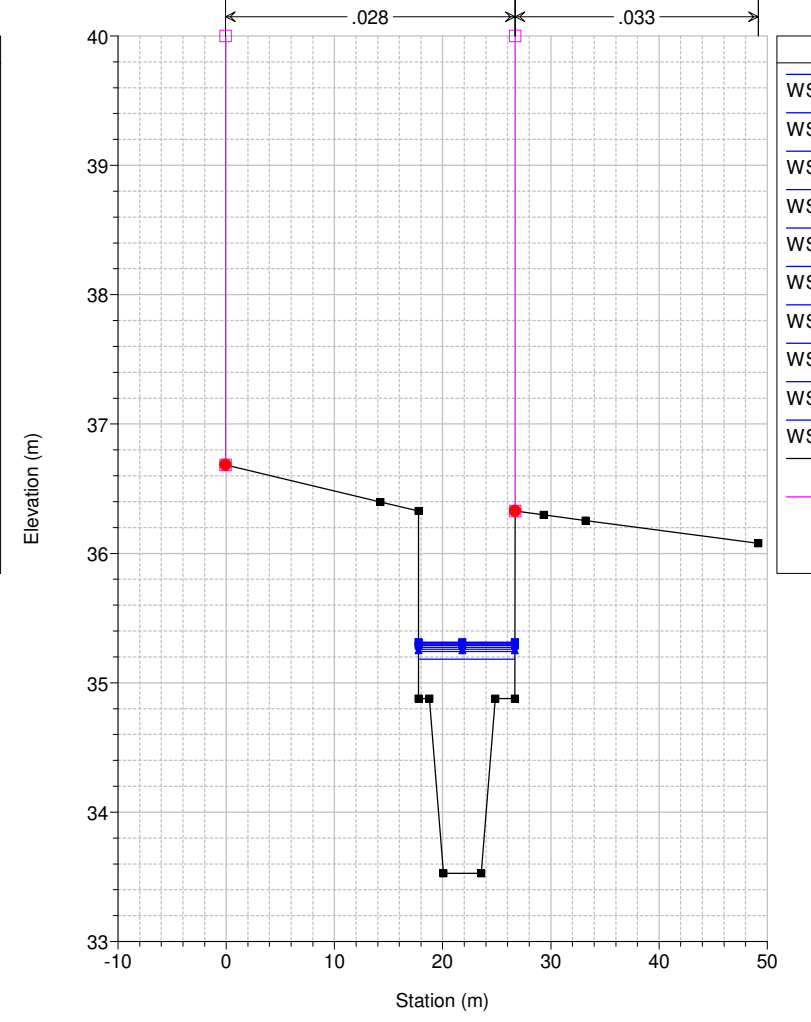

Legend	
WS Max WS - TR030_12_0	✕
WS Max WS - TR030_06_0	■
WS Max WS - TR030_18_0	+
WS Max WS - TR030_09_0	●
WS Max WS - TR030_24_0	▼
WS Max WS - TR030_03_0	✕
WS Max WS - TR030_36_0	+
WS Max WS - TR030_01_5	▼
WS Max WS - TR030_01_0	▲
WS Max WS - TR030_00_5	▲
Ground	■
Levee	□
Bank Sta	●

Studio Scandicci Torrenti Greve-Vingone
River = Fosso Rigone Reach = Rigone 03 RS = 27 RI1016_D

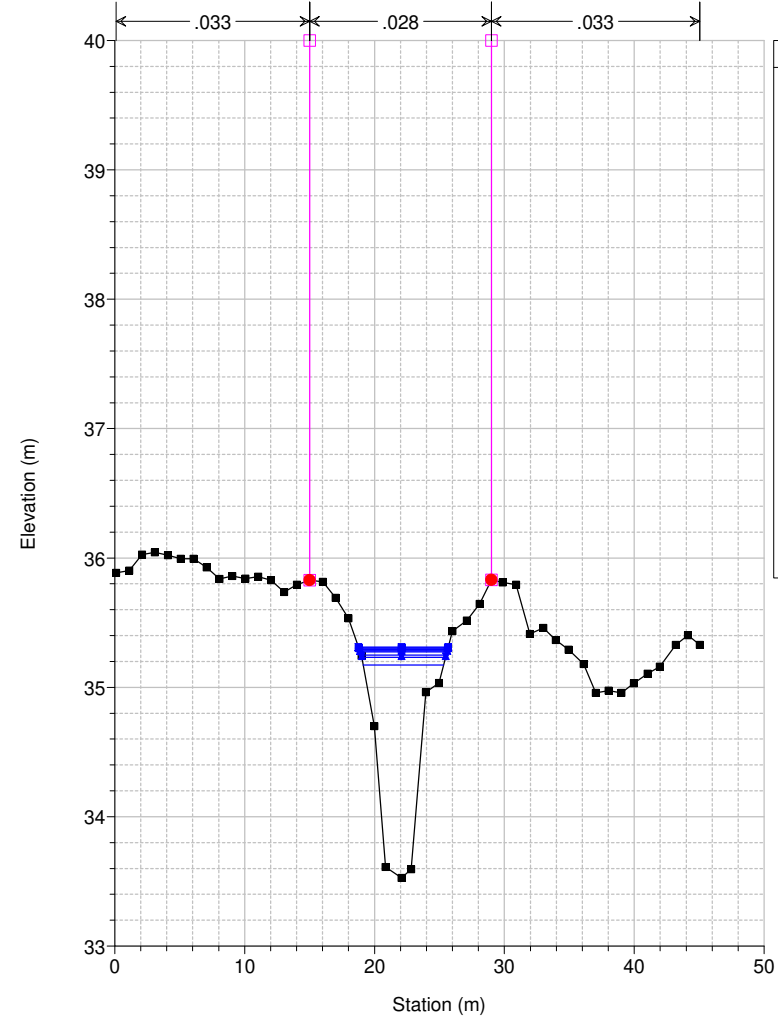

Studio Scandicci Torrenti Greve-Vingone
River = Fosso Rigone Reach = Rigone 03 RS = 26 RI0017_

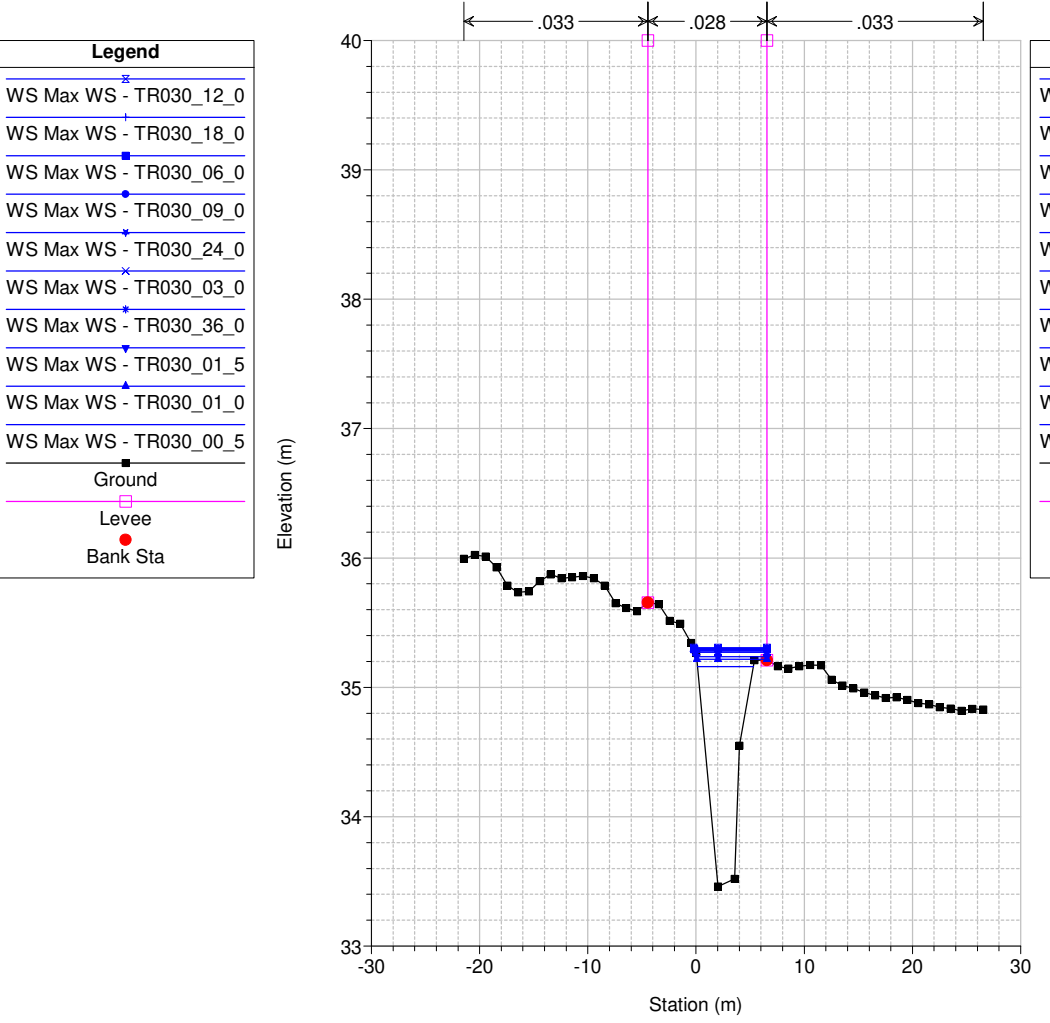

Studio Scandicci Torrenti Greve-Vingone
River = Fosso Rigone Reach = Rigone 03 RS = 25.4

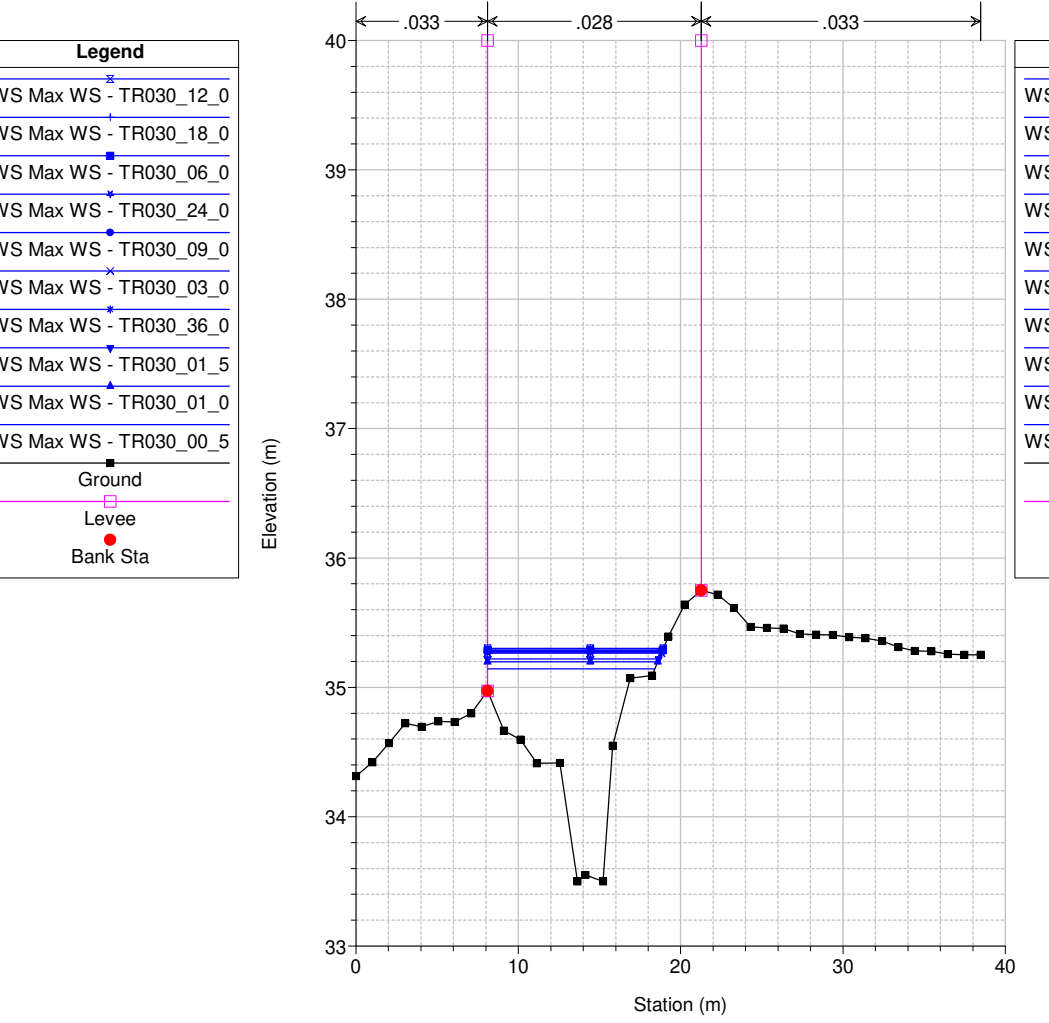

Studio Scandicci Torrenti Greve-Vingone
River = Fosso Rigone Reach = Rigone 02 RS = 25 RI0018_A

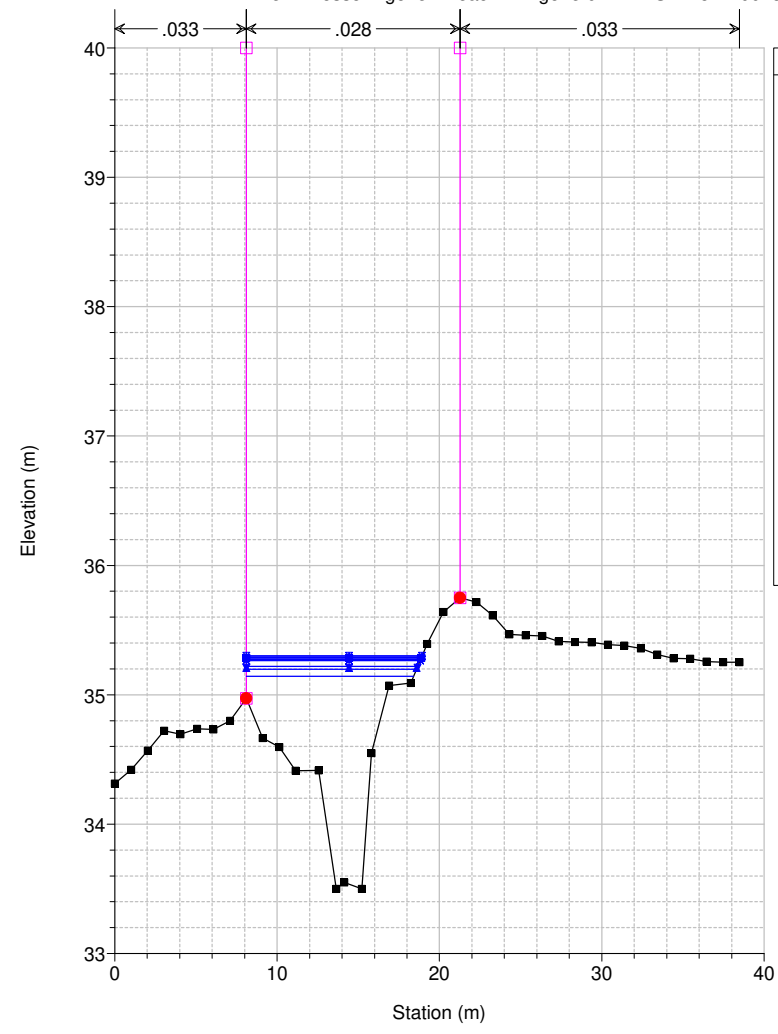

Studio Scandicci Torrenti Greve-Vingone
River = Fosso Rigone Reach = Rigone 02 RS = 24 RI0018_B

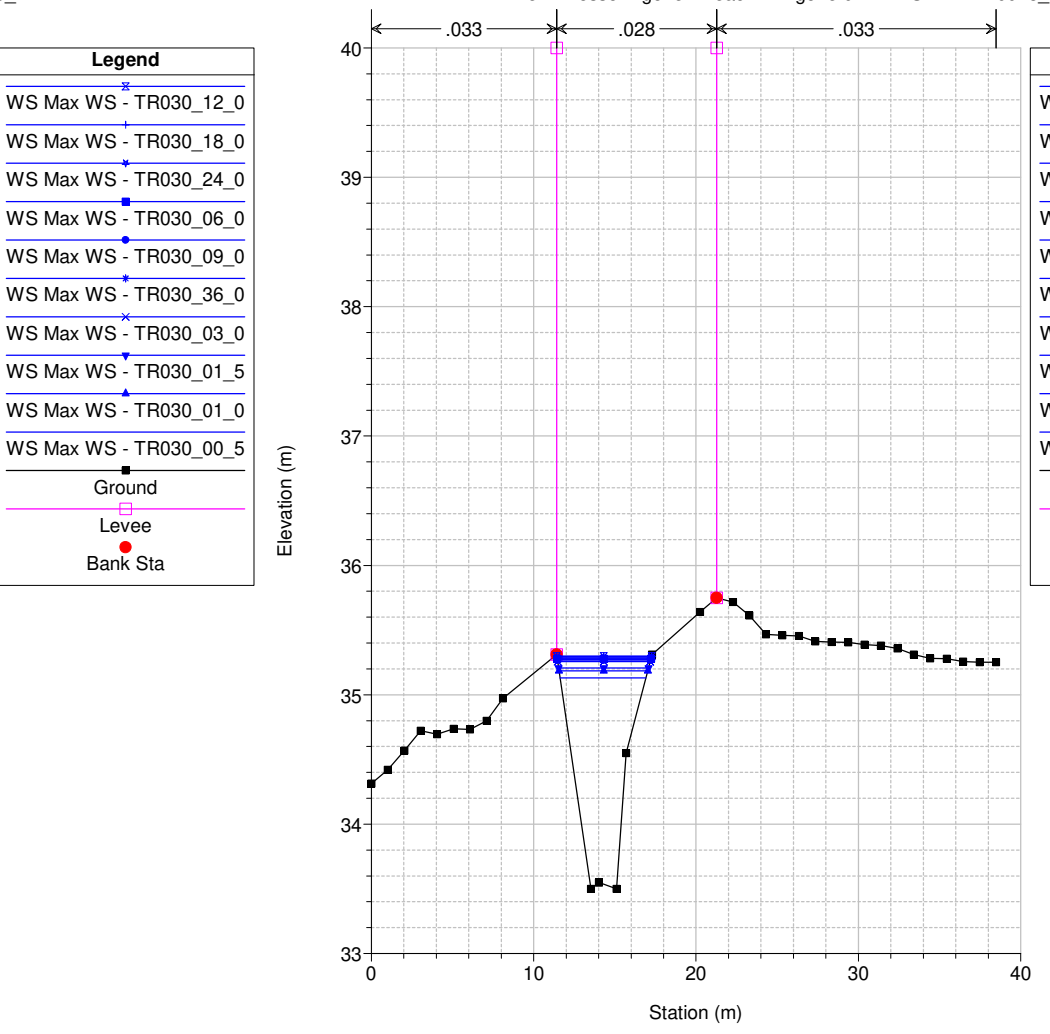

Studio Scandicci Torrenti Greve-Vingone
River = Fosso Rigone Reach = Rigone 02 RS = 23.5 BR

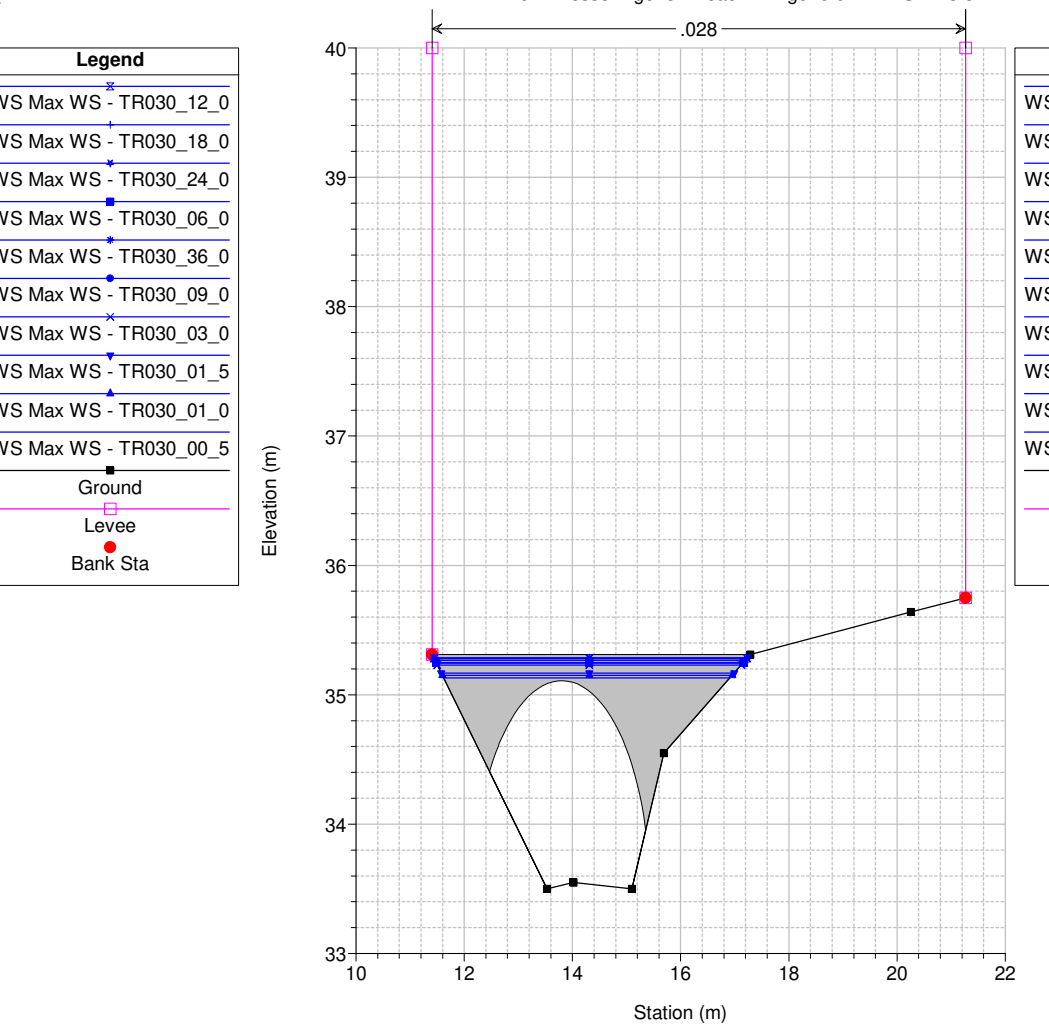

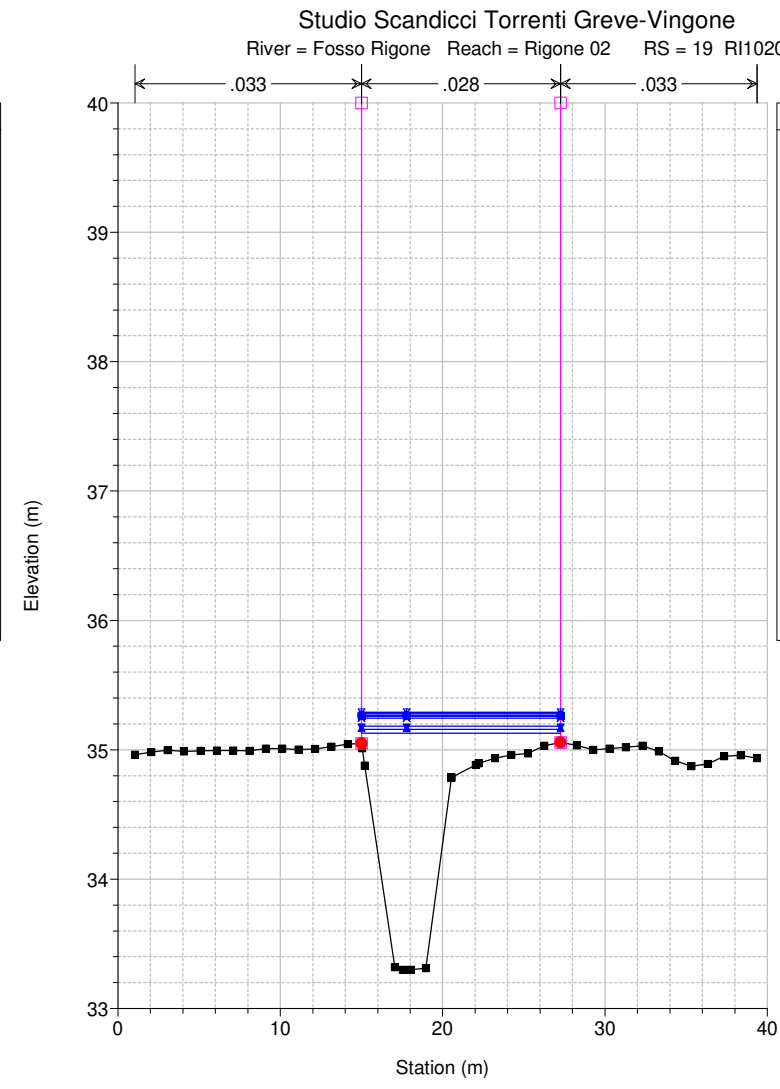
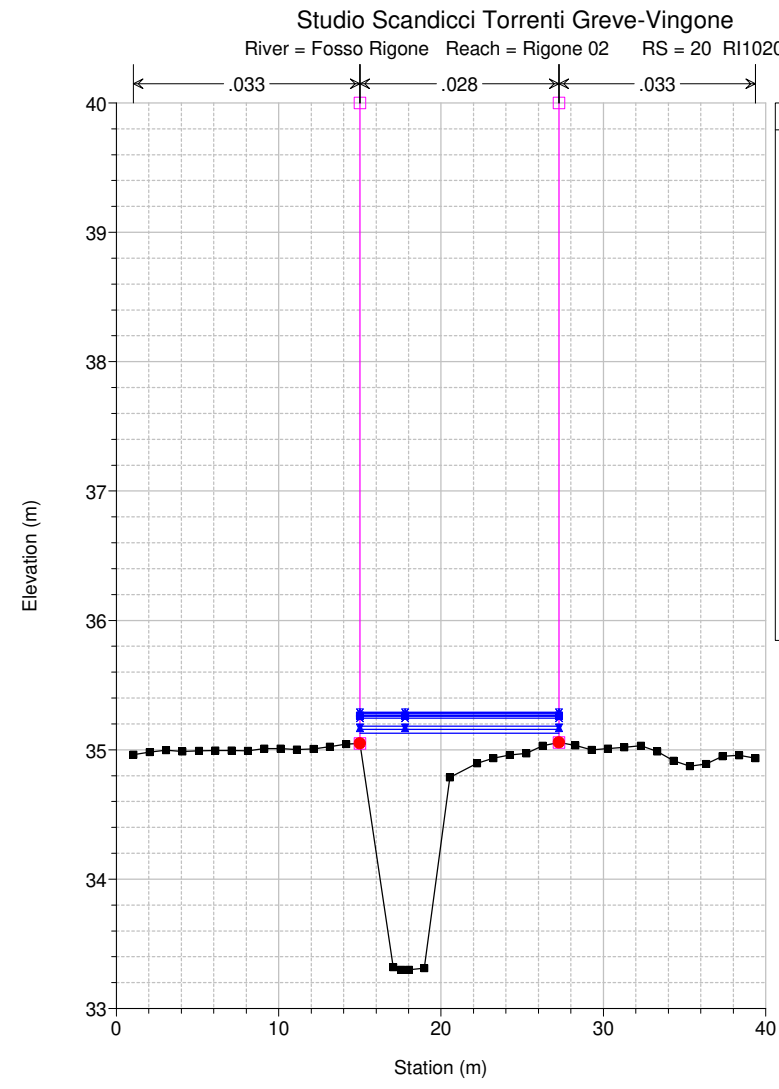
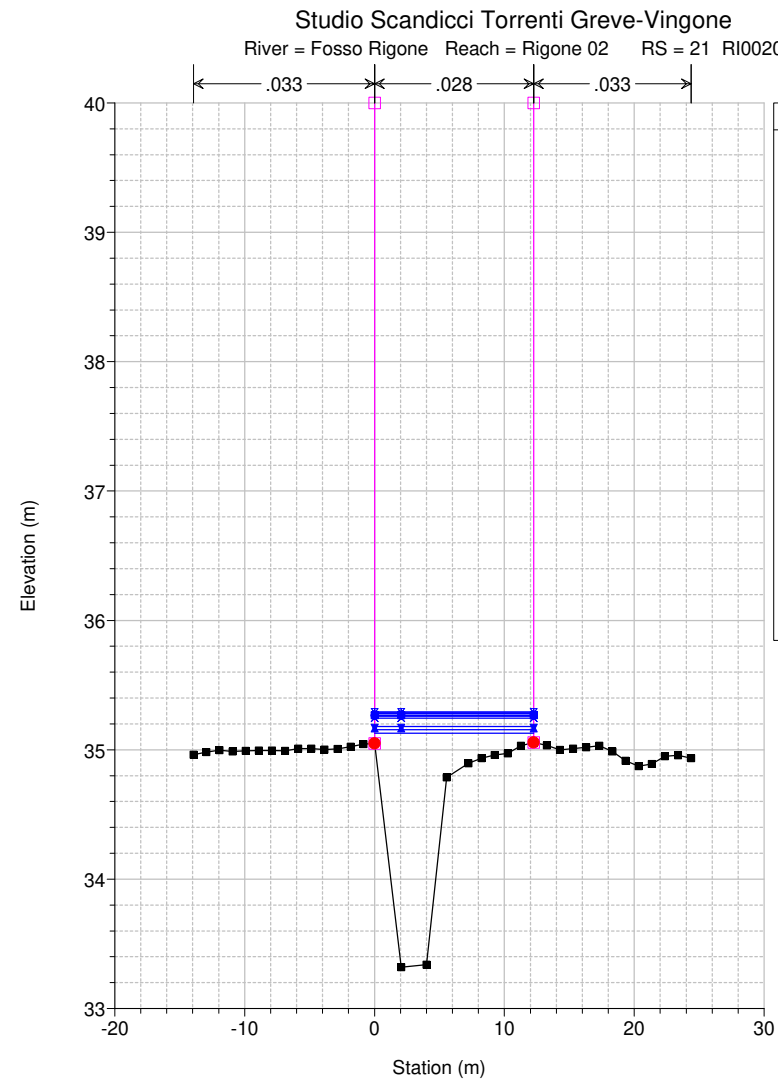
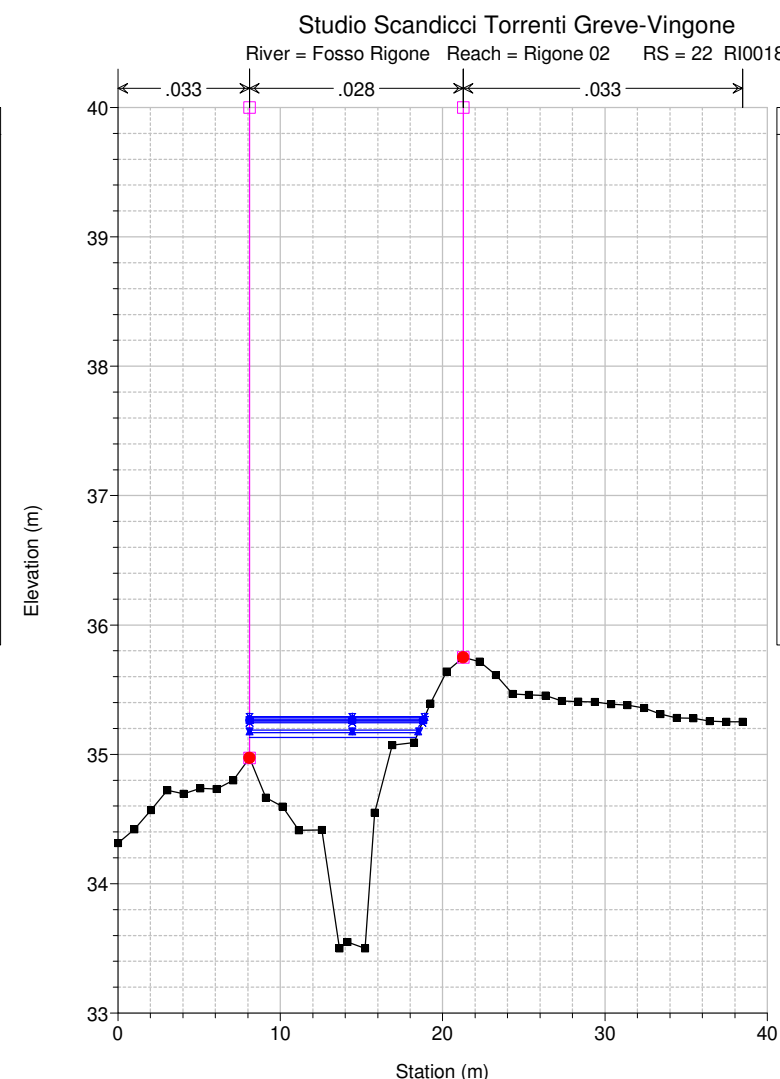
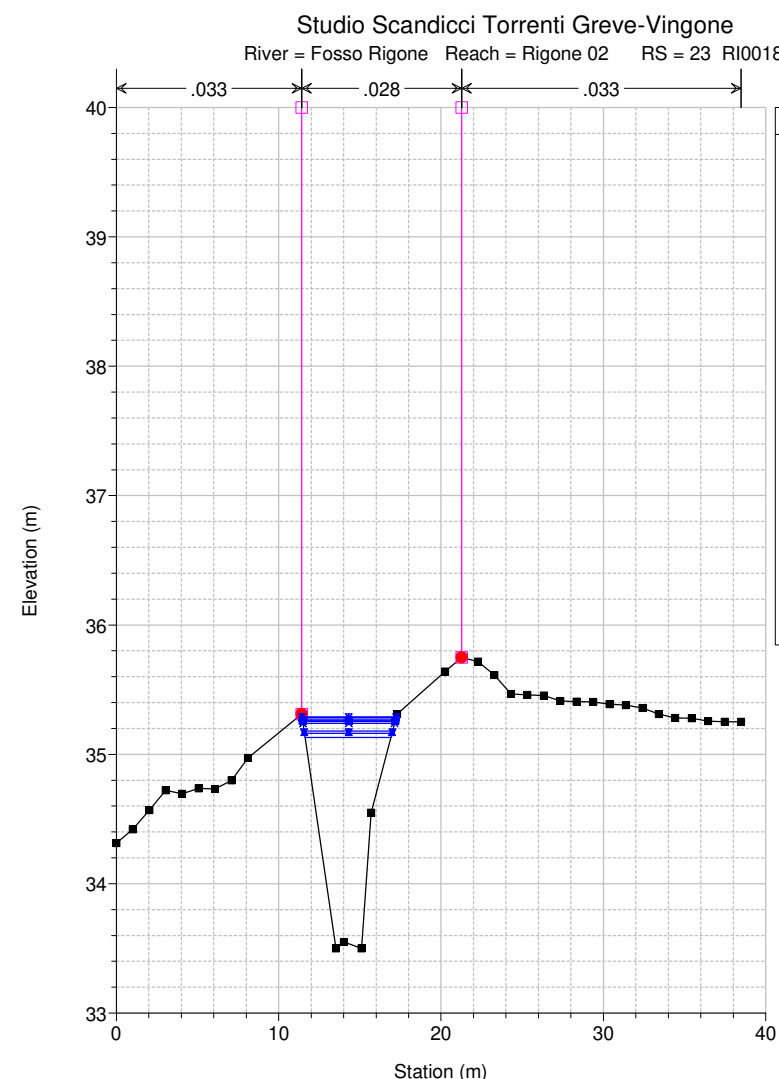
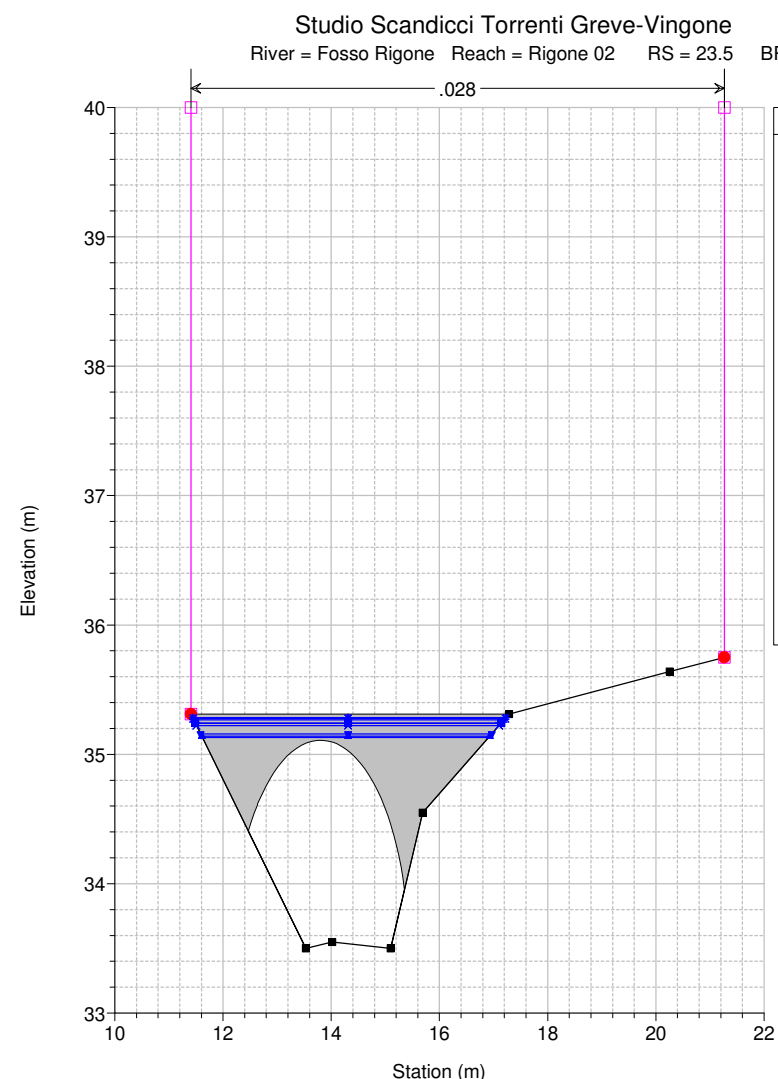

Studio Scandicci Torrenti Greve-Vingone
River = Fosso Rigone Reach = Rigone 02 RS = 18.5 BR

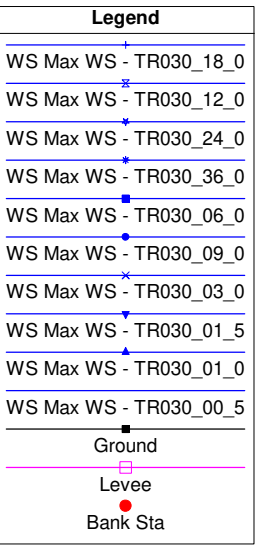
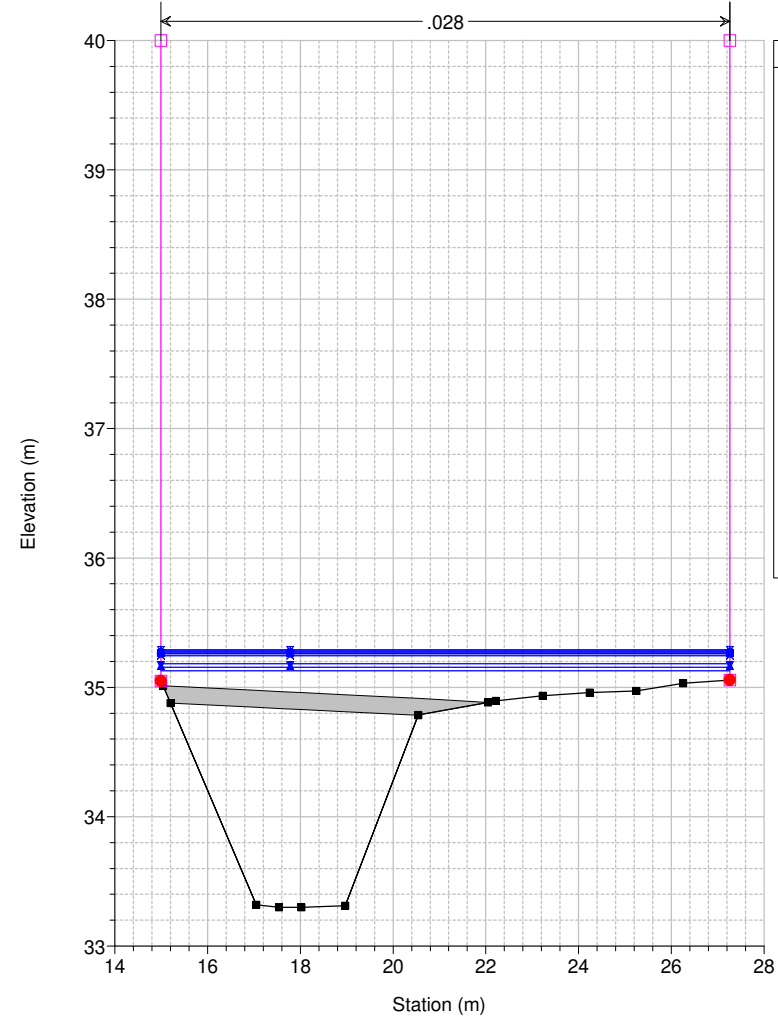

Studio Scandicci Torrenti Greve-Vingone
River = Fosso Rigone Reach = Rigone 02 RS = 18.5 BR

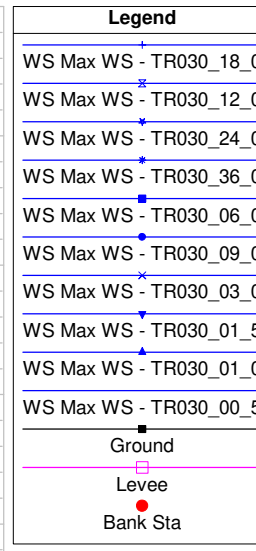
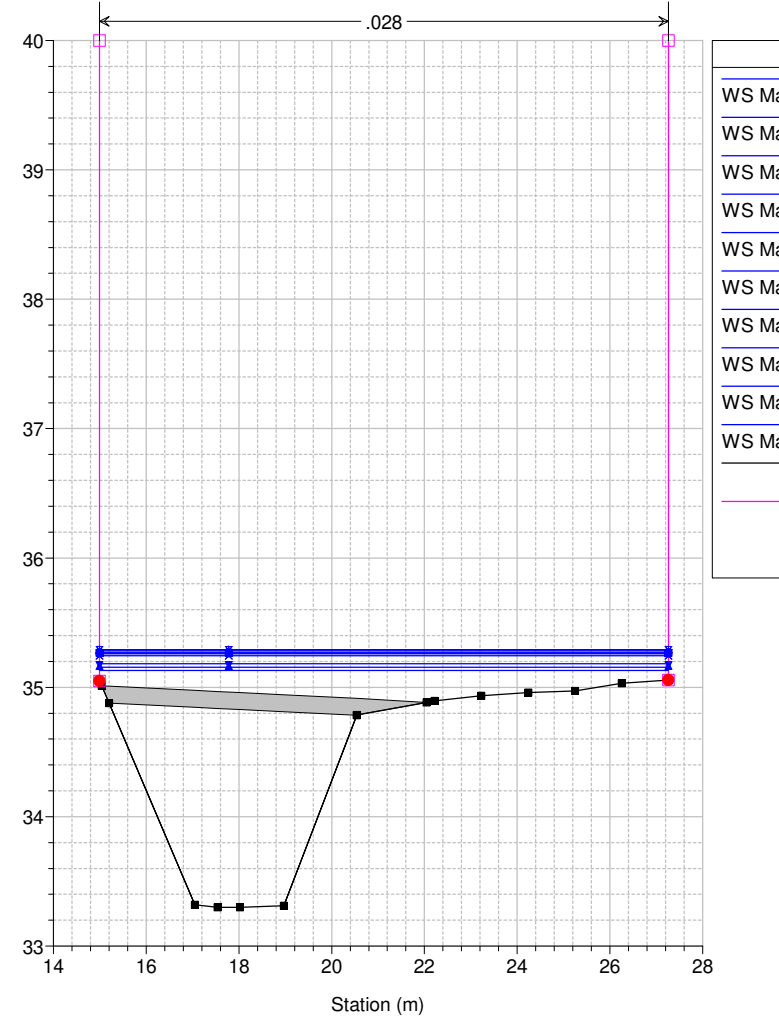

Studio Scandicci Torrenti Greve-Vingone
River = Fosso Rigone Reach = Rigone 02 RS = 18 RI1020_C

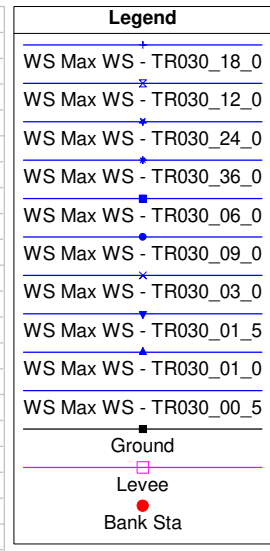
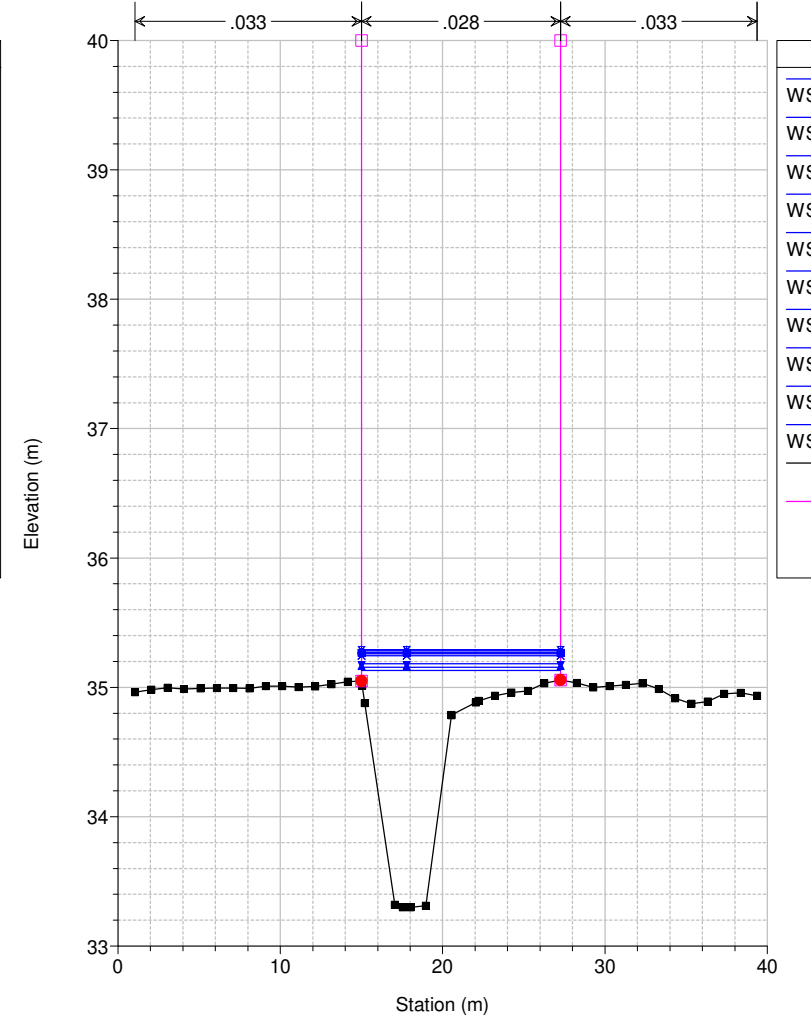

Studio Scandicci Torrenti Greve-Vingone
River = Fosso Rigone Reach = Rigone 02 RS = 17 RI1020_D

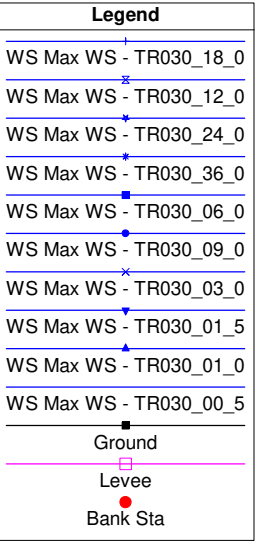
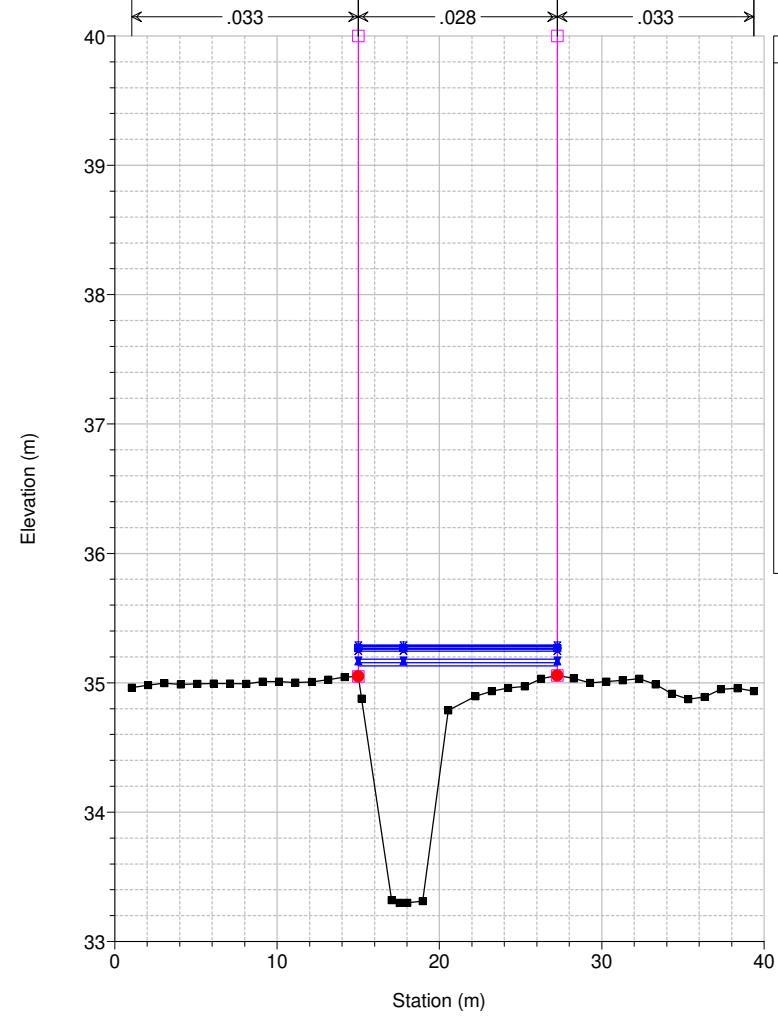

Studio Scandicci Torrenti Greve-Vingone
River = Fosso Rigone Reach = Rigone 02 RS = 16 RI0021_A

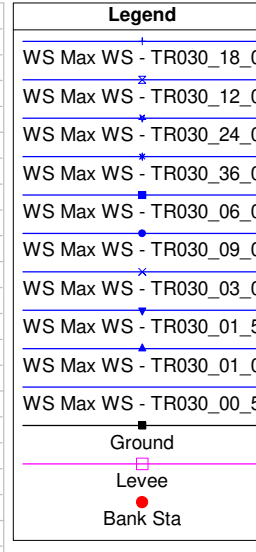
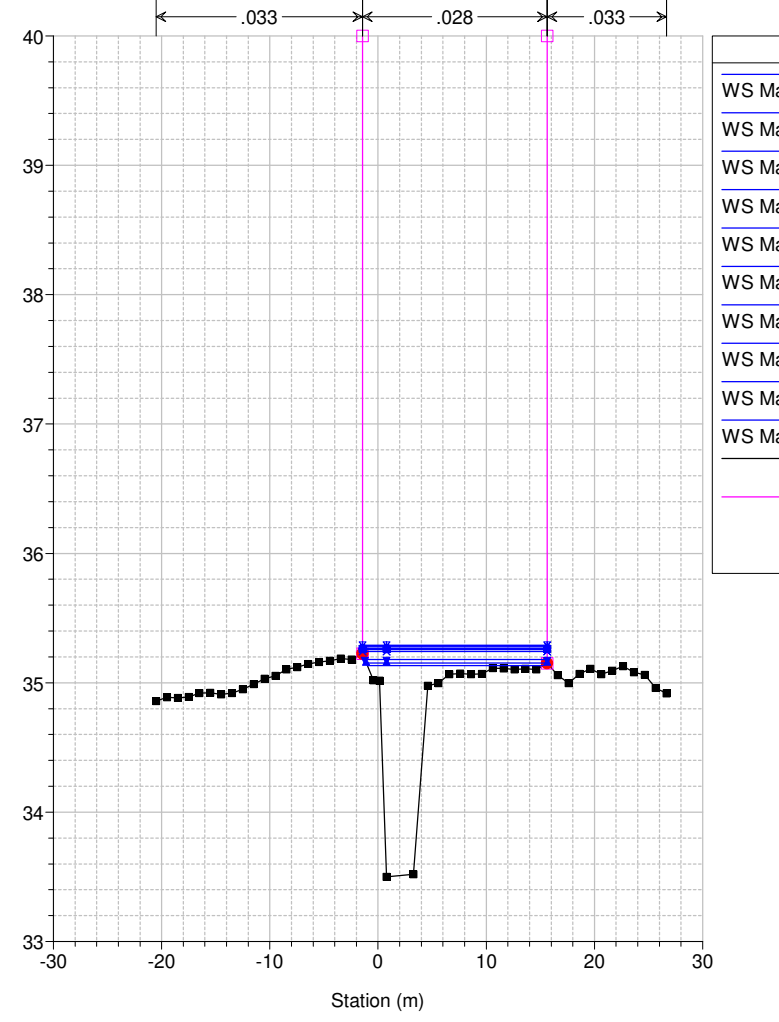

Studio Scandicci Torrenti Greve-Vingone
River = Fosso Rigone Reach = Rigone 02 RS = 15 RI0021_B

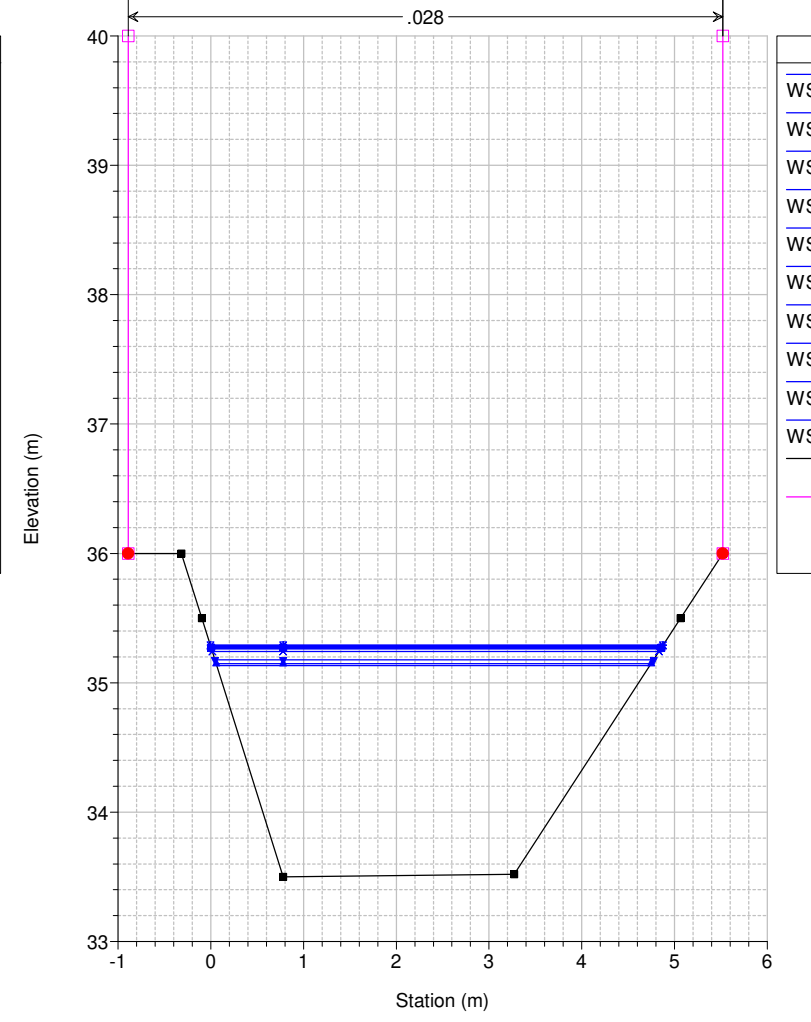

Studio Scandicci Torrenti Greve-Vingone
River = Fosso Rigone Reach = Rigone 02 RS = 14.75 BR

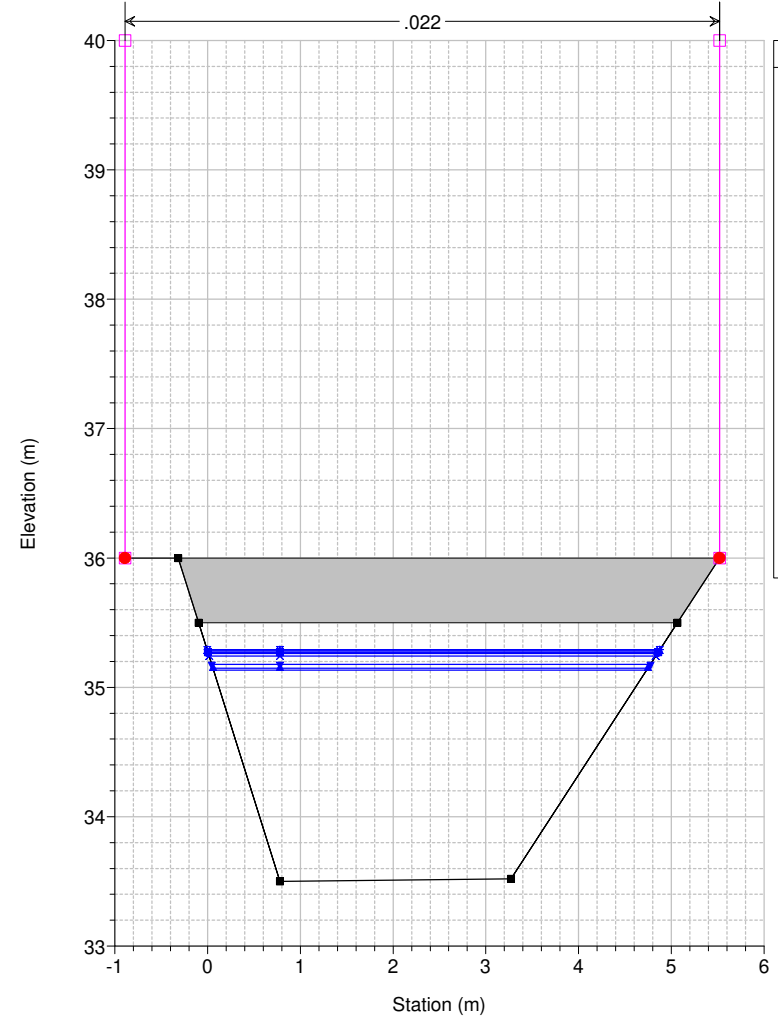

Legend	
WS Max WS - TR030_18_0	+
WS Max WS - TR030_12_0	x
WS Max WS - TR030_24_0	*
WS Max WS - TR030_06_0	■
WS Max WS - TR030_36_0	●
WS Max WS - TR030_09_0	•
WS Max WS - TR030_03_0	x
WS Max WS - TR030_01_5	▼
WS Max WS - TR030_01_0	▲
WS Max WS - TR030_00_5	■
Ground	—
Levee	—
Bank Sta	●

Studio Scandicci Torrenti Greve-Vingone
River = Fosso Rigone Reach = Rigone 02 RS = 14.75 BR

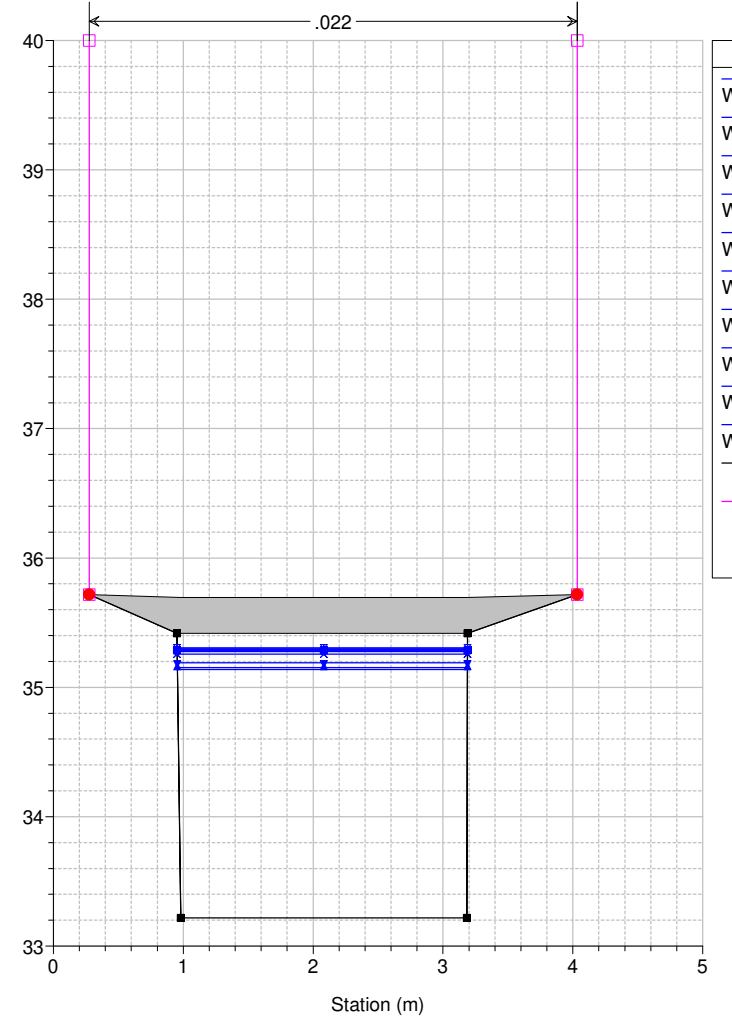

Legend	
WS Max WS - TR030_12_0	x
WS Max WS - TR030_18_0	+
WS Max WS - TR030_24_0	*
WS Max WS - TR030_06_0	■
WS Max WS - TR030_36_0	●
WS Max WS - TR030_09_0	•
WS Max WS - TR030_03_0	x
WS Max WS - TR030_01_5	▼
WS Max WS - TR030_01_0	▲
WS Max WS - TR030_00_5	■
Ground	—
Levee	—
Bank Sta	●

Studio Scandicci Torrenti Greve-Vingone
River = Fosso Rigone Reach = Rigone 02 RS = 14.4

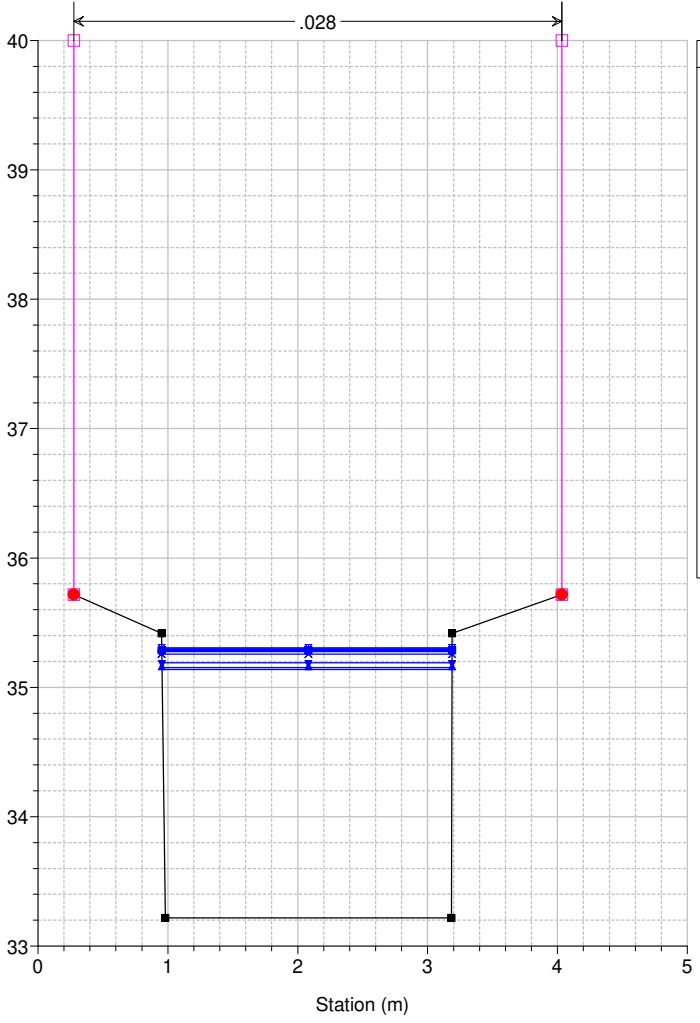

Legend	
WS Max WS - TR030_12_0	x
WS Max WS - TR030_18_0	+
WS Max WS - TR030_24_0	*
WS Max WS - TR030_06_0	■
WS Max WS - TR030_36_0	●
WS Max WS - TR030_09_0	•
WS Max WS - TR030_03_0	x
WS Max WS - TR030_01_5	▼
WS Max WS - TR030_01_0	▲
WS Max WS - TR030_00_5	■
Ground	—
Levee	—
Bank Sta	●

Studio Scandicci Torrenti Greve-Vingone
River = Fosso Rigone Reach = Rigone 02 RS = 14 R10021_C

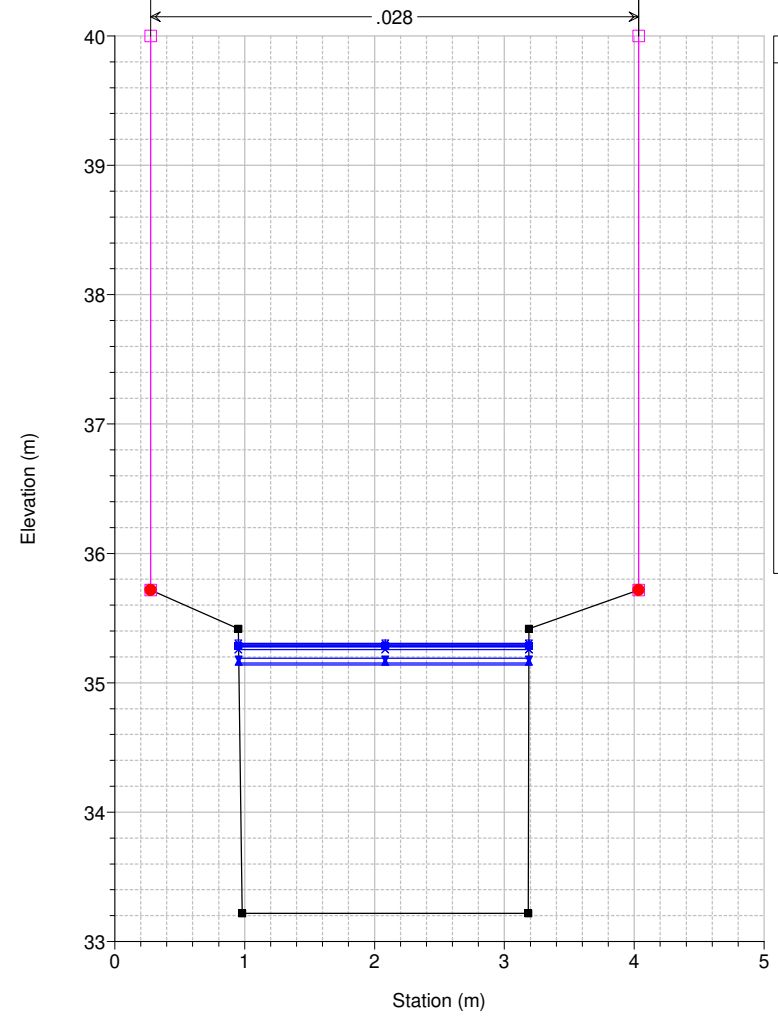

Legend	
WS Max WS - TR030_12_0	x
WS Max WS - TR030_18_0	+
WS Max WS - TR030_24_0	*
WS Max WS - TR030_06_0	■
WS Max WS - TR030_36_0	●
WS Max WS - TR030_09_0	•
WS Max WS - TR030_03_0	x
WS Max WS - TR030_01_5	▼
WS Max WS - TR030_01_0	▲
WS Max WS - TR030_00_5	■
Ground	—
Levee	—
Bank Sta	●

Studio Scandicci Torrenti Greve-Vingone
River = Fosso Rigone Reach = Rigone 02 RS = 13.75 Culv

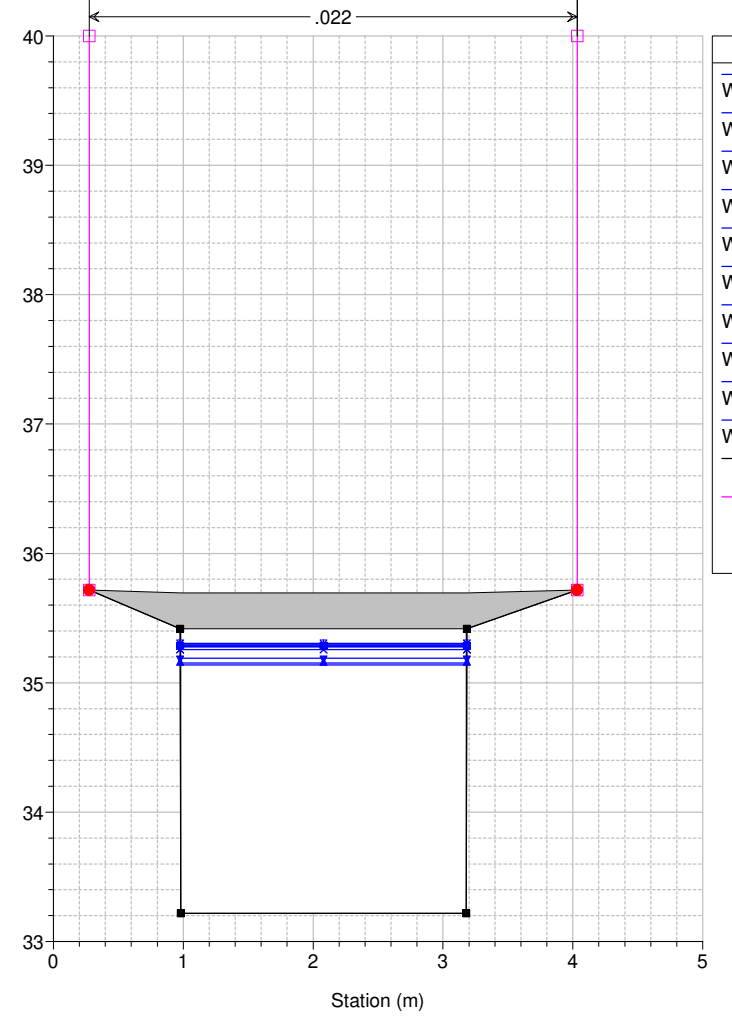

Legend	
WS Max WS - TR030_12_0	x
WS Max WS - TR030_18_0	+
WS Max WS - TR030_24_0	*
WS Max WS - TR030_06_0	■
WS Max WS - TR030_36_0	●
WS Max WS - TR030_09_0	•
WS Max WS - TR030_03_0	x
WS Max WS - TR030_01_5	▼
WS Max WS - TR030_01_0	▲
WS Max WS - TR030_00_5	■
Ground	—
Levee	—
Bank Sta	●

Studio Scandicci Torrenti Greve-Vingone
River = Fosso Rigone Reach = Rigone 02 RS = 13.75 Culv

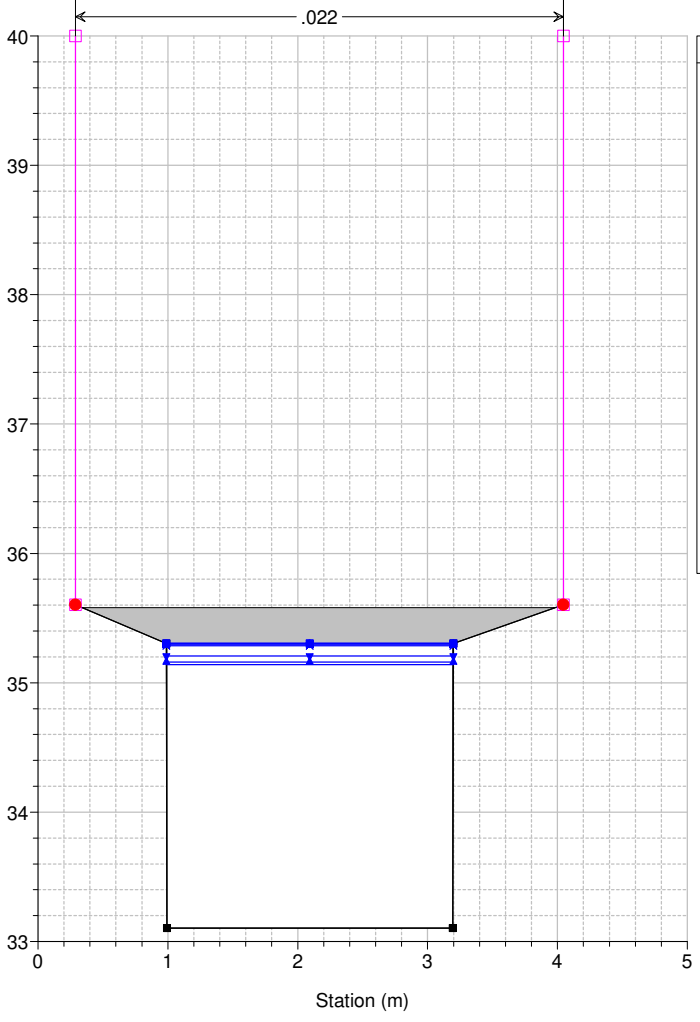

Legend	
WS Max WS - TR030_06_0	■
WS Max WS - TR030_09_0	●
WS Max WS - TR030_12_0	x
WS Max WS - TR030_18_0	+
WS Max WS - TR030_24_0	*
WS Max WS - TR030_36_0	●
WS Max WS - TR030_06_0	■
WS Max WS - TR030_12_0	x
WS Max WS - TR030_03_0	x
WS Max WS - TR030_01_5	▼
WS Max WS - TR030_01_0	▲
WS Max WS - TR030_00_5	■
Ground	—
Levee	—
Bank Sta	●

Studio Scandicci Torrenti Greve-Vingone
River = Fosso Rigone Reach = Rigone 02 RS = 13.4

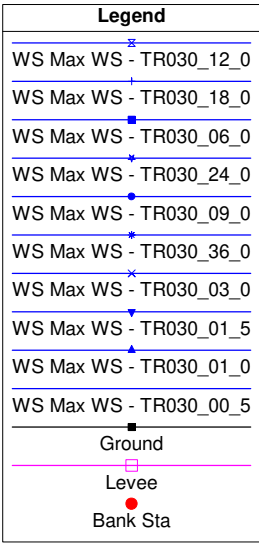
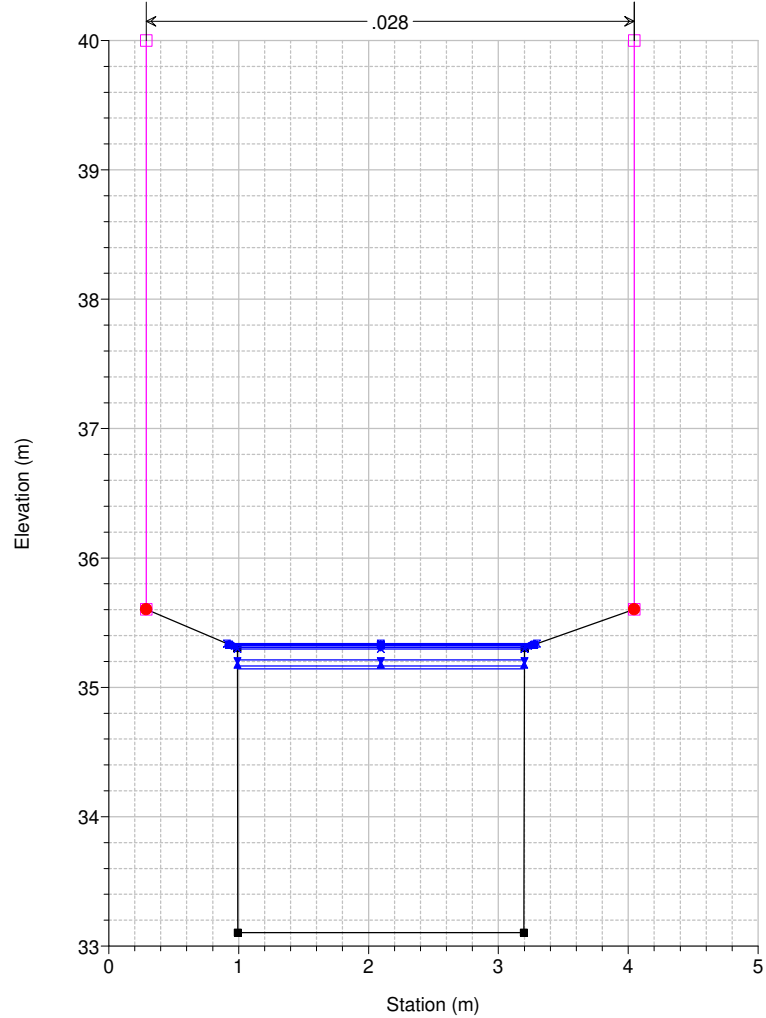

Studio Scandicci Torrenti Greve-Vingone
River = Fosso Rigone Reach = Rigone 02 RS = 13 RI0021_D

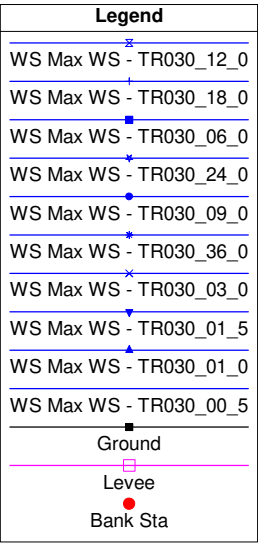
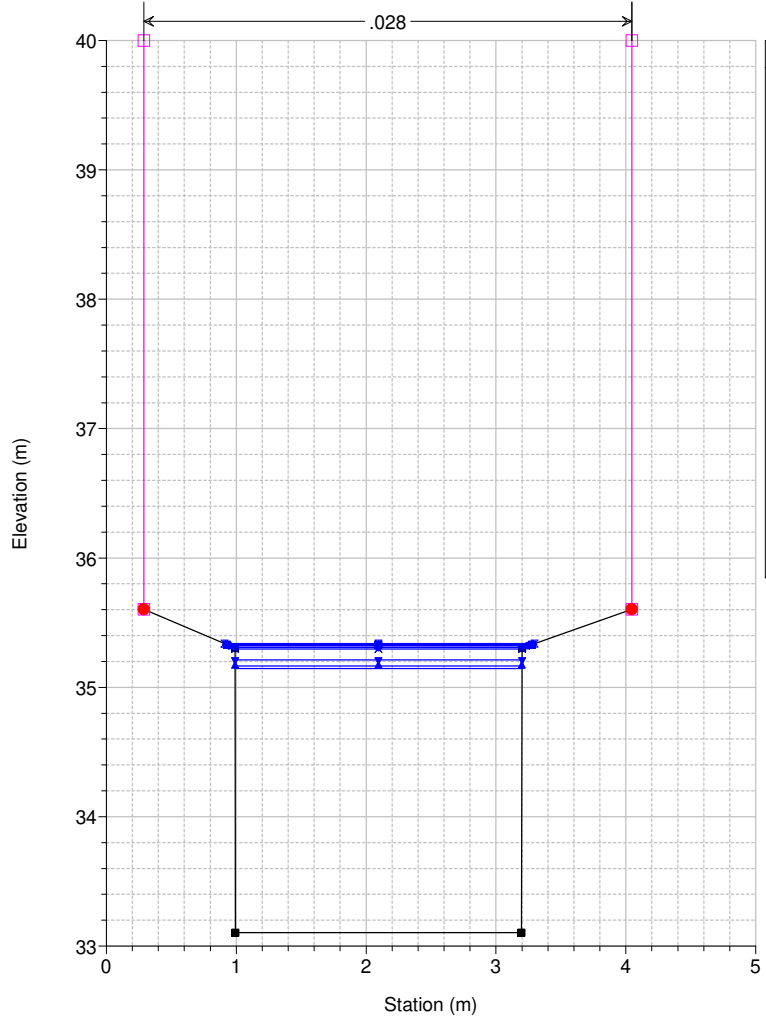

Studio Scandicci Torrenti Greve-Vingone
River = Fosso Rigone Reach = Rigone 02 RS = 12.75 BR

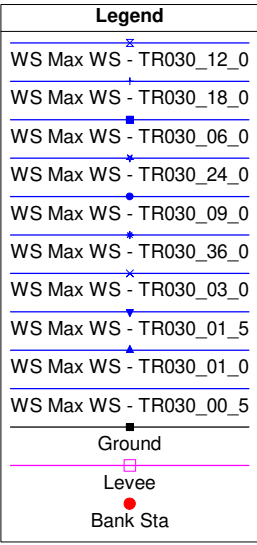
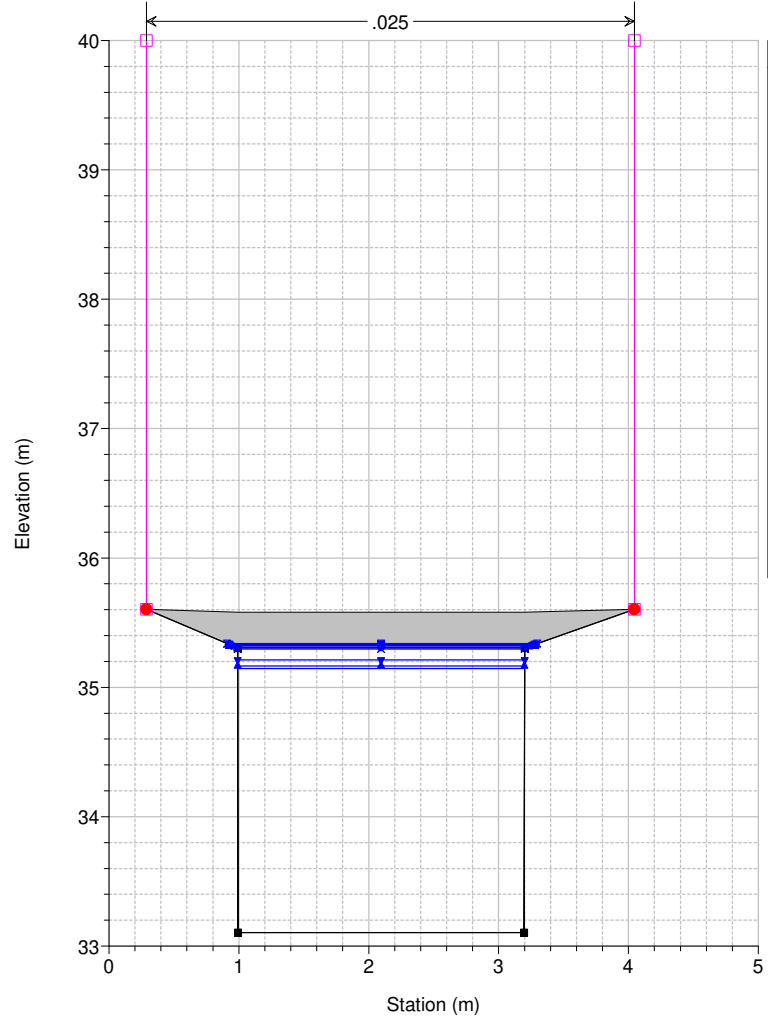

Studio Scandicci Torrenti Greve-Vingone
River = Fosso Rigone Reach = Rigone 02 RS = 12.75 BR

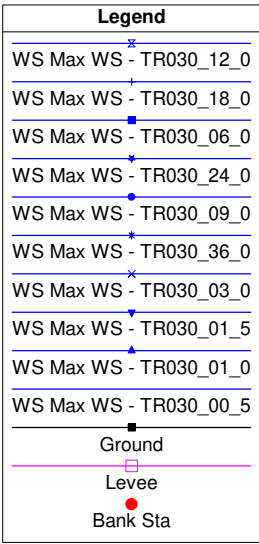
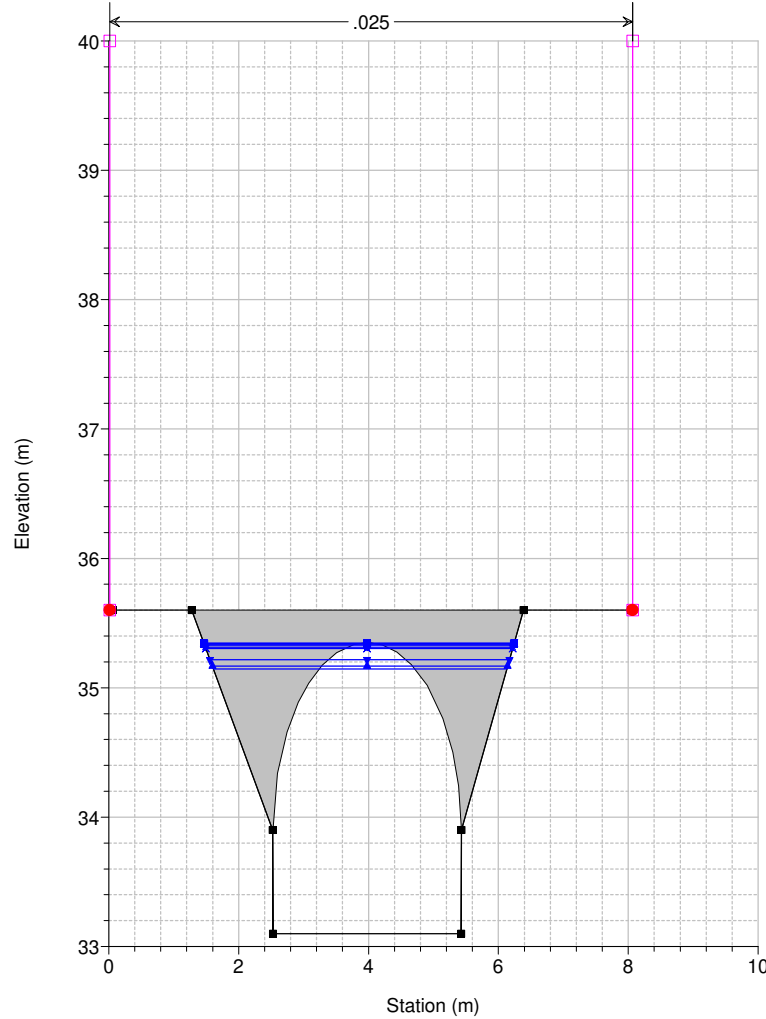

Studio Scandicci Torrenti Greve-Vingone
River = Fosso Rigone Reach = Rigone 02 RS = 12.4

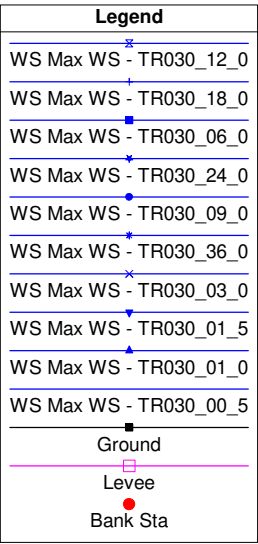
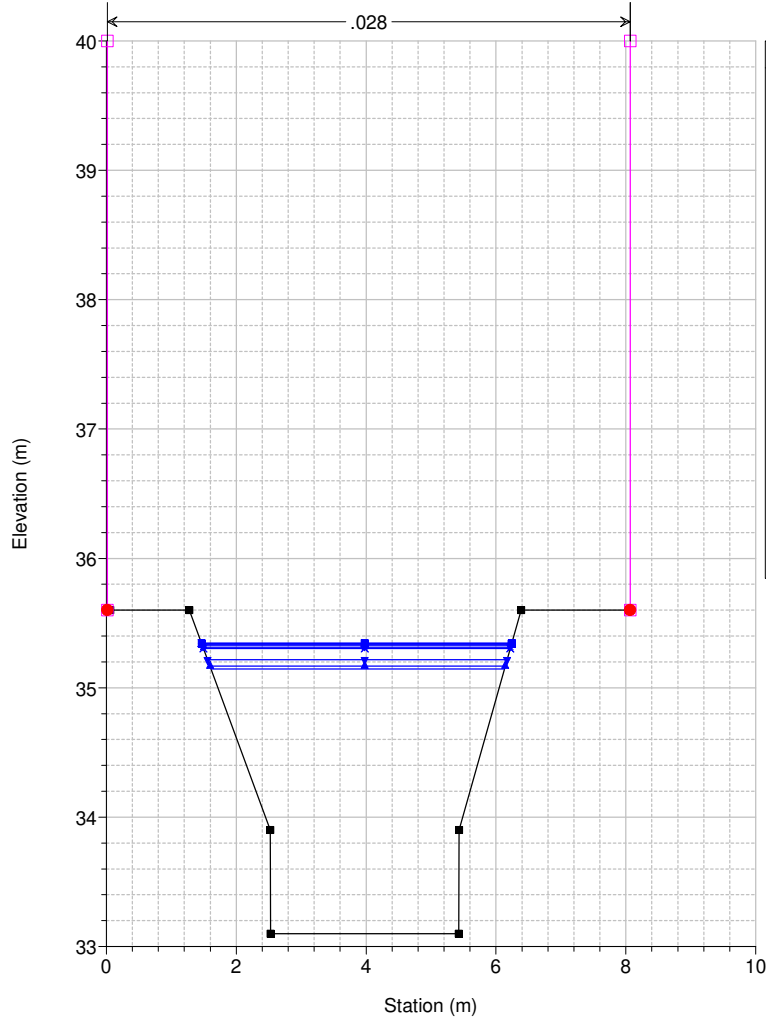

Studio Scandicci Torrenti Greve-Vingone
River = Fosso Rigone Reach = Rigone 02 RS = 12 RI0022_B

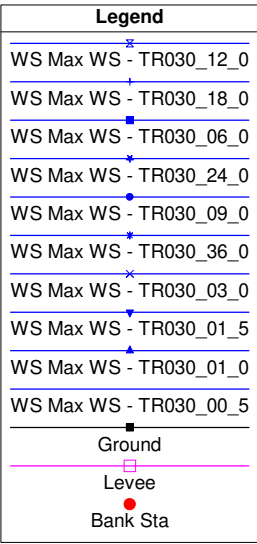
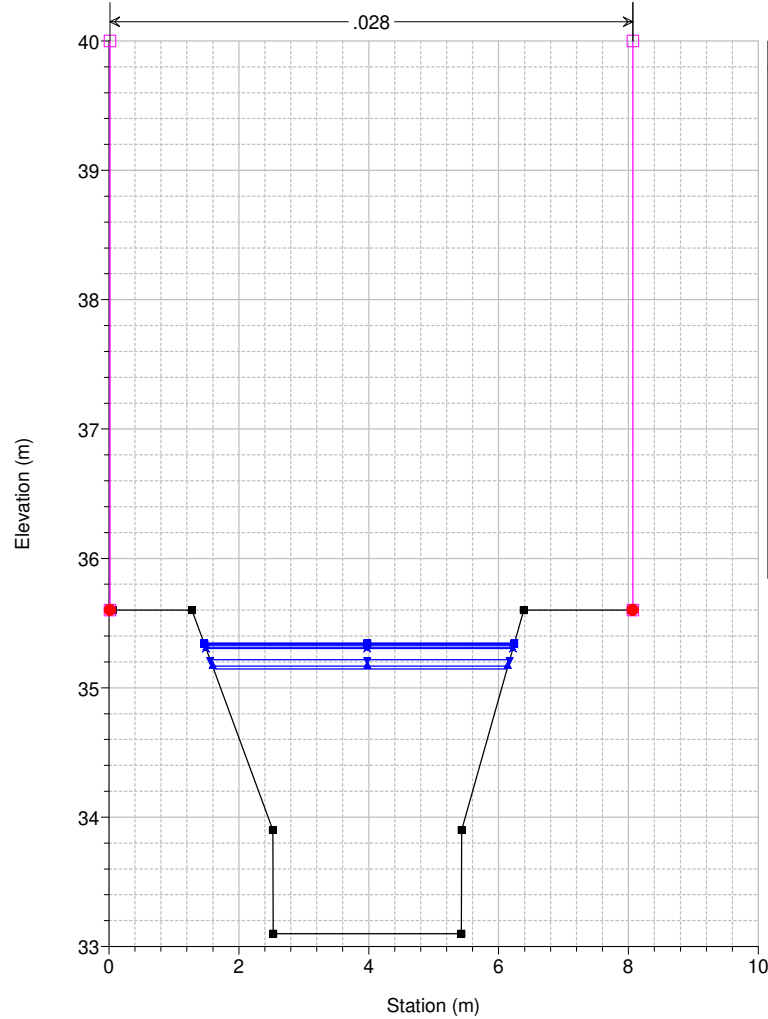

Studio Scandicci Torrenti Greve-Vingone
River = Fosso Rigone Reach = Rigone 02 RS = 11.5 BR

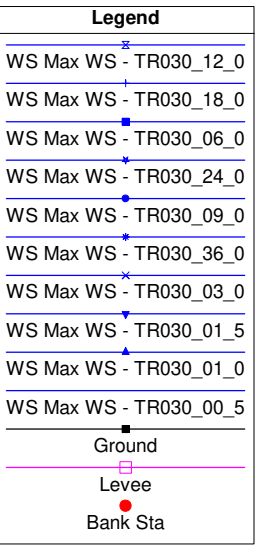
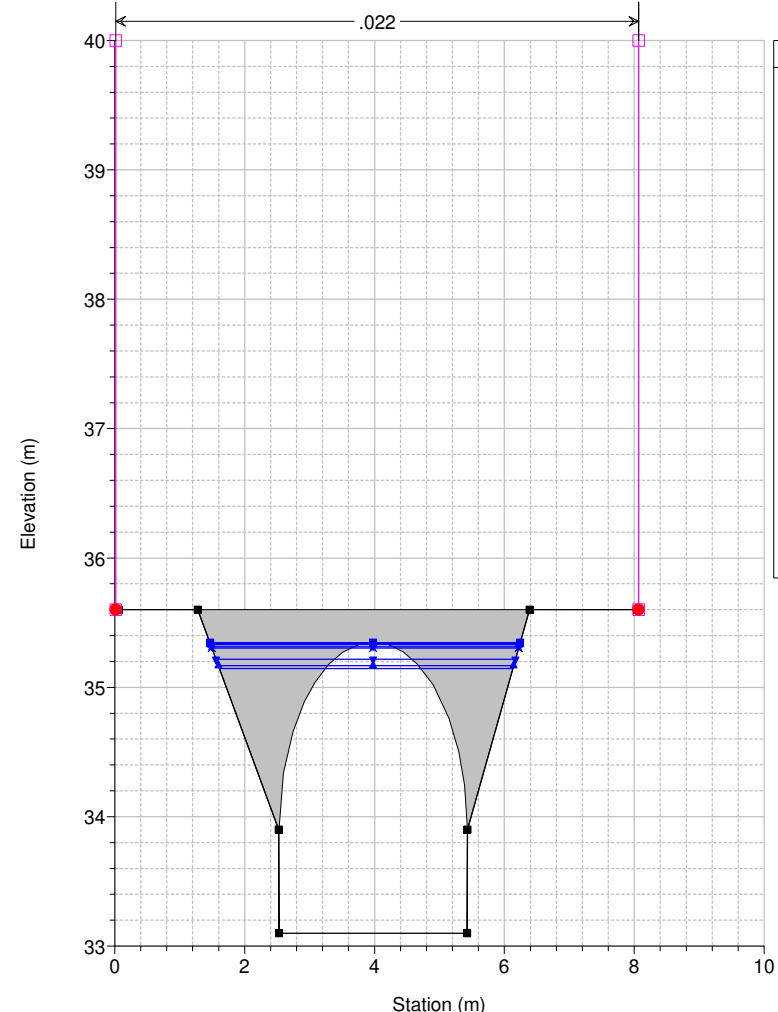

Studio Scandicci Torrenti Greve-Vingone
River = Fosso Rigone Reach = Rigone 02 RS = 11.5 BR

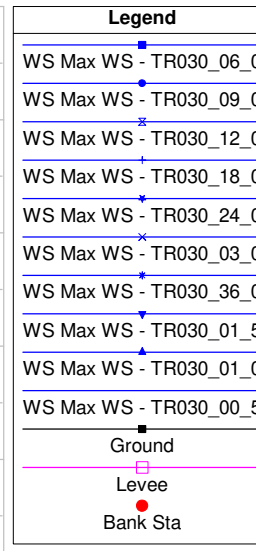
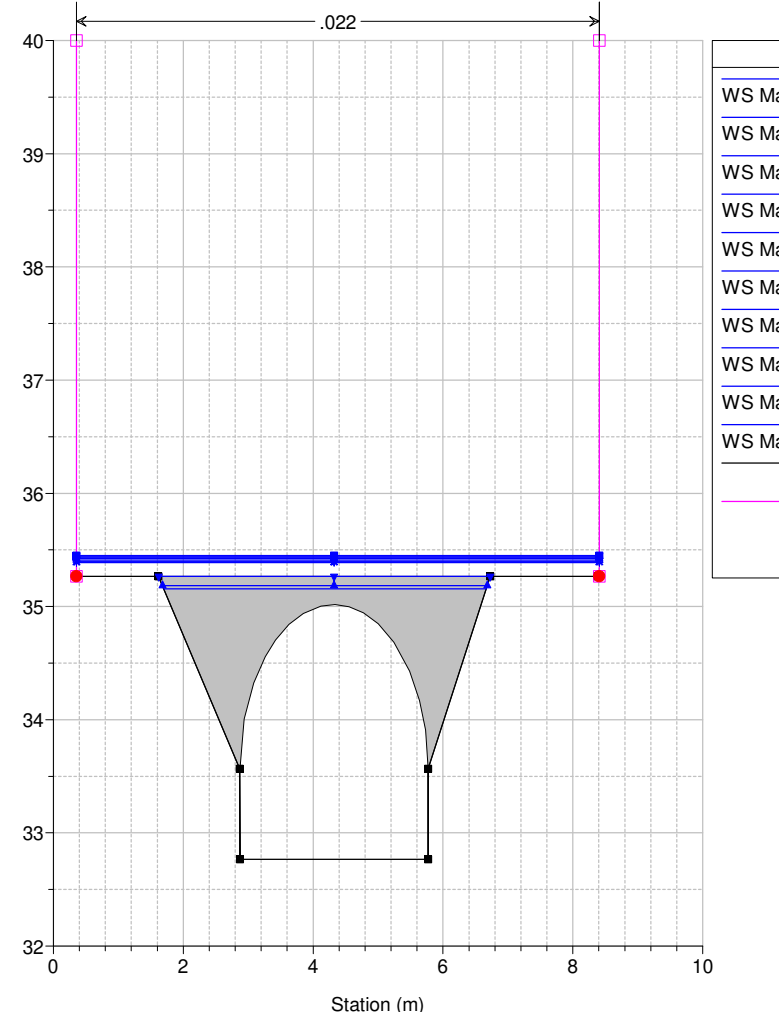

Studio Scandicci Torrenti Greve-Vingone
River = Fosso Rigone Reach = Rigone 02 RS = 11 RI0022_C

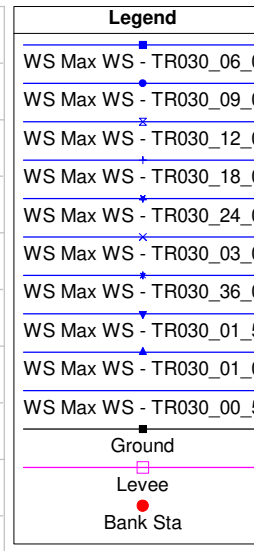
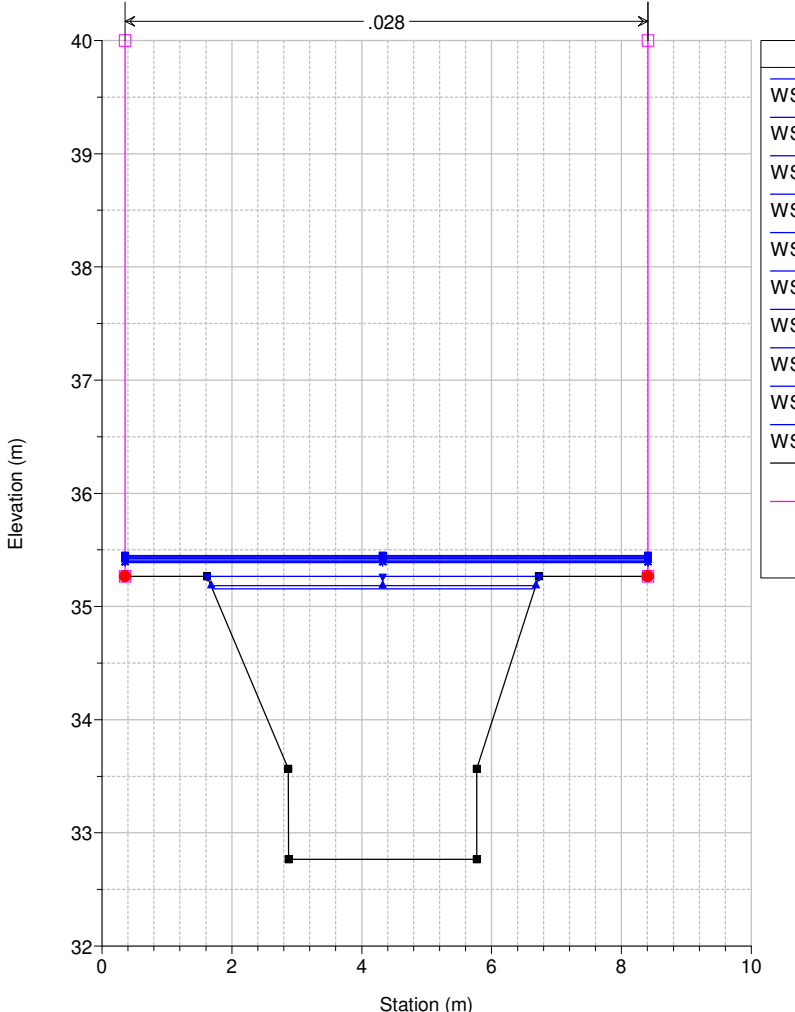

Studio Scandicci Torrenti Greve-Vingone
River = Fosso Rigone Reach = Rigone 02 RS = 10.6

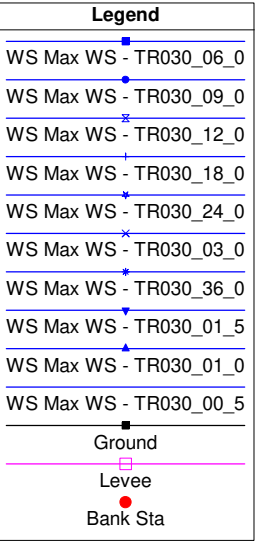
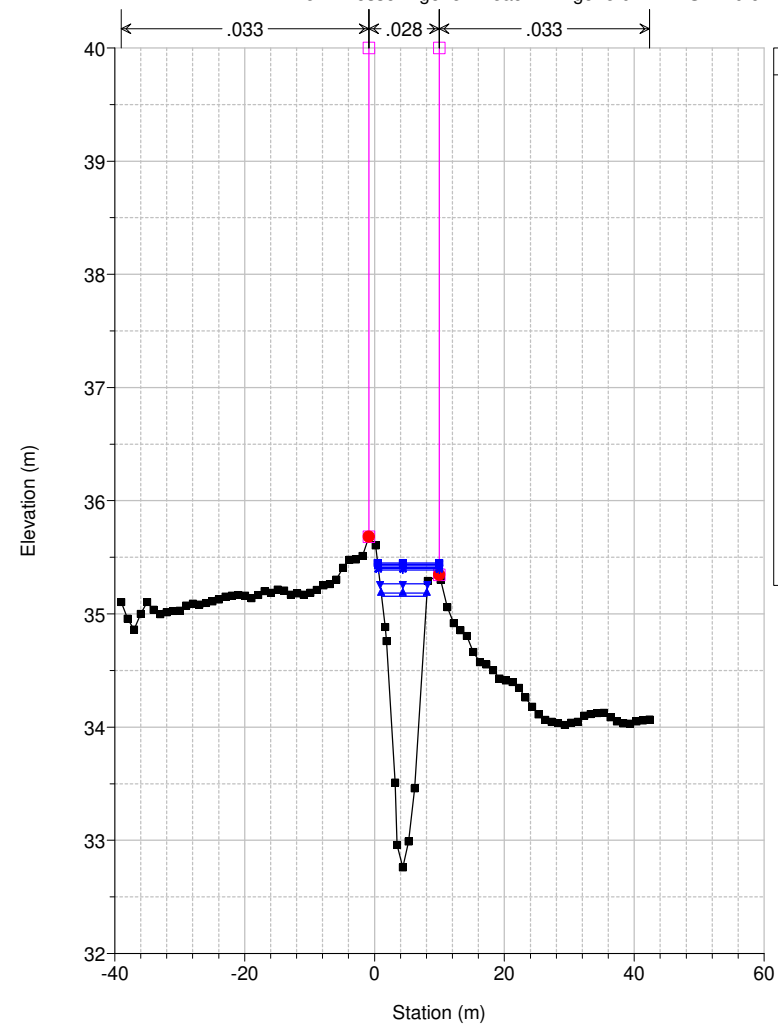

Studio Scandicci Torrenti Greve-Vingone
River = Fosso Rigone Reach = Rigone 01 RS = 10 DO0032_D

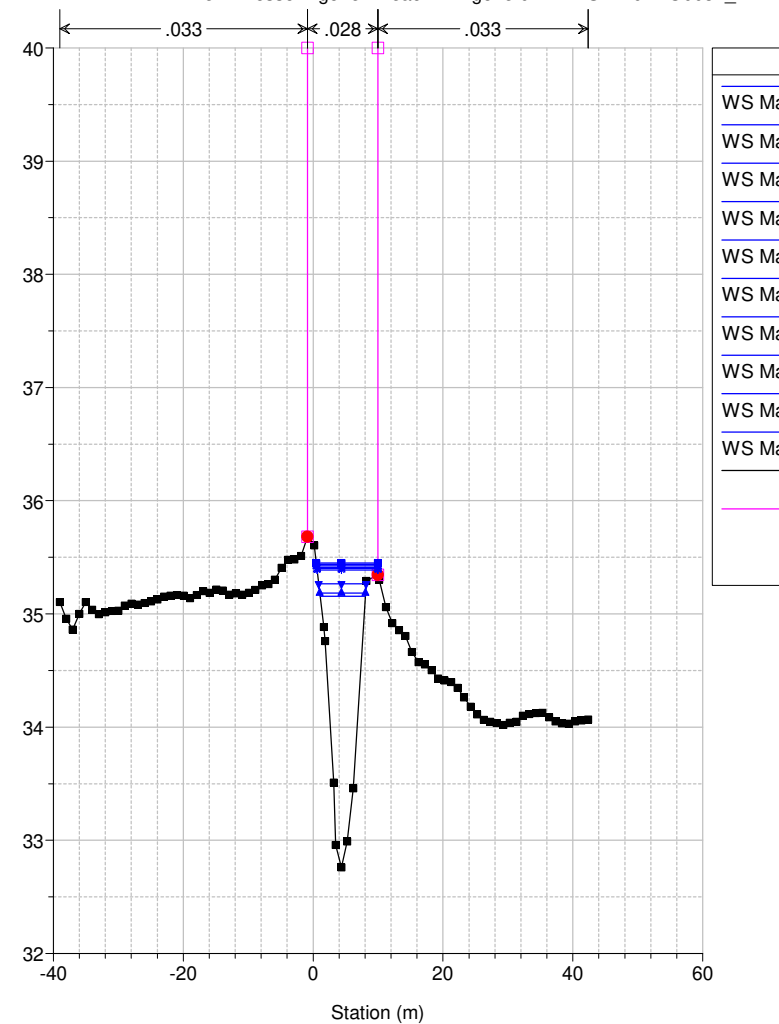

Studio Scandicci Torrenti Greve-Vingone
River = Fosso Rigone Reach = Rigone 01 RS = 9 DO1033_A

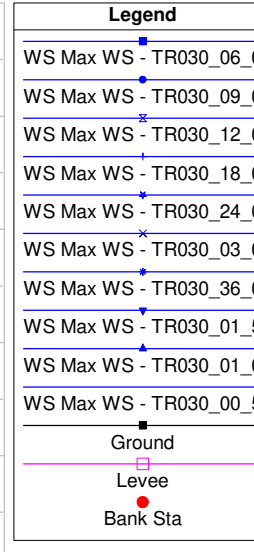
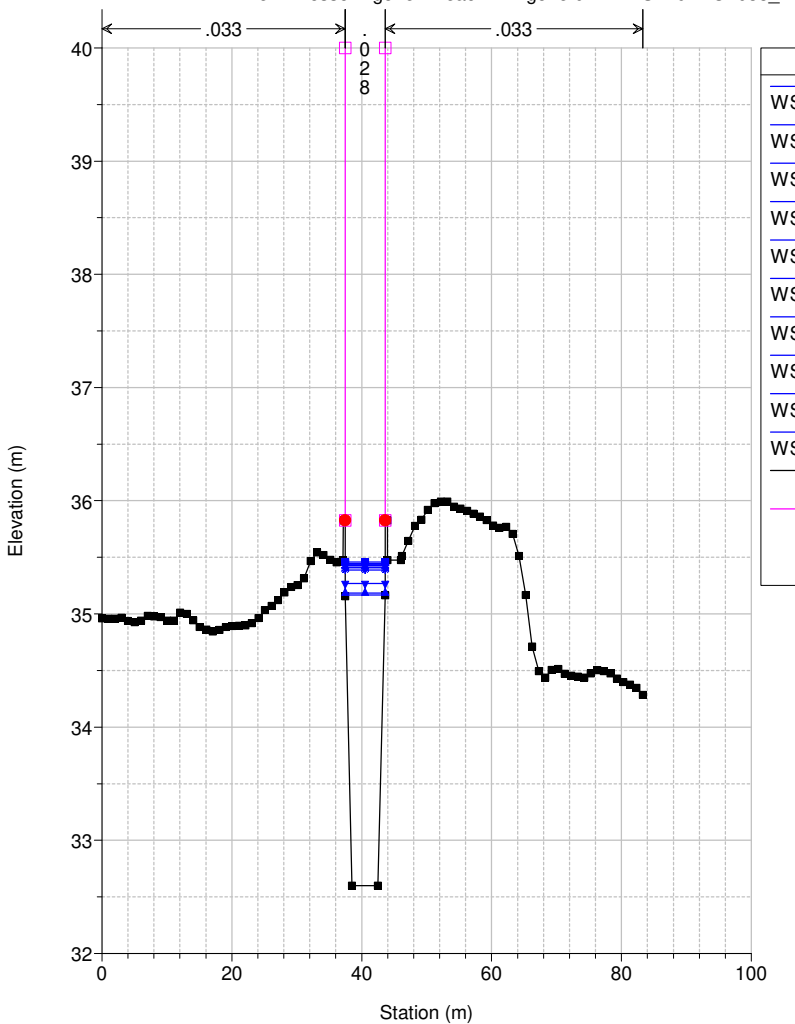

Studio Scandicci Torrenti Greve-Vingone
River = Fosso Rigone Reach = Rigone 01 RS = 8 DO1033_B

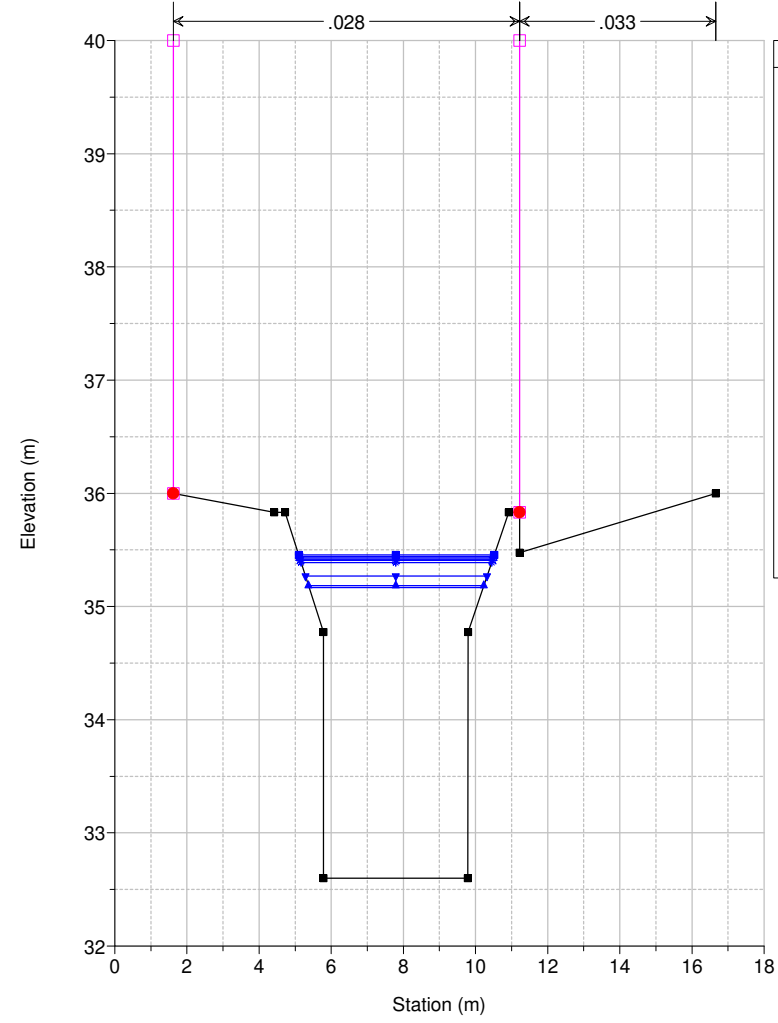

Studio Scandicci Torrenti Greve-Vingone
River = Fosso Rigone Reach = Rigone 01 RS = 7.5 BR

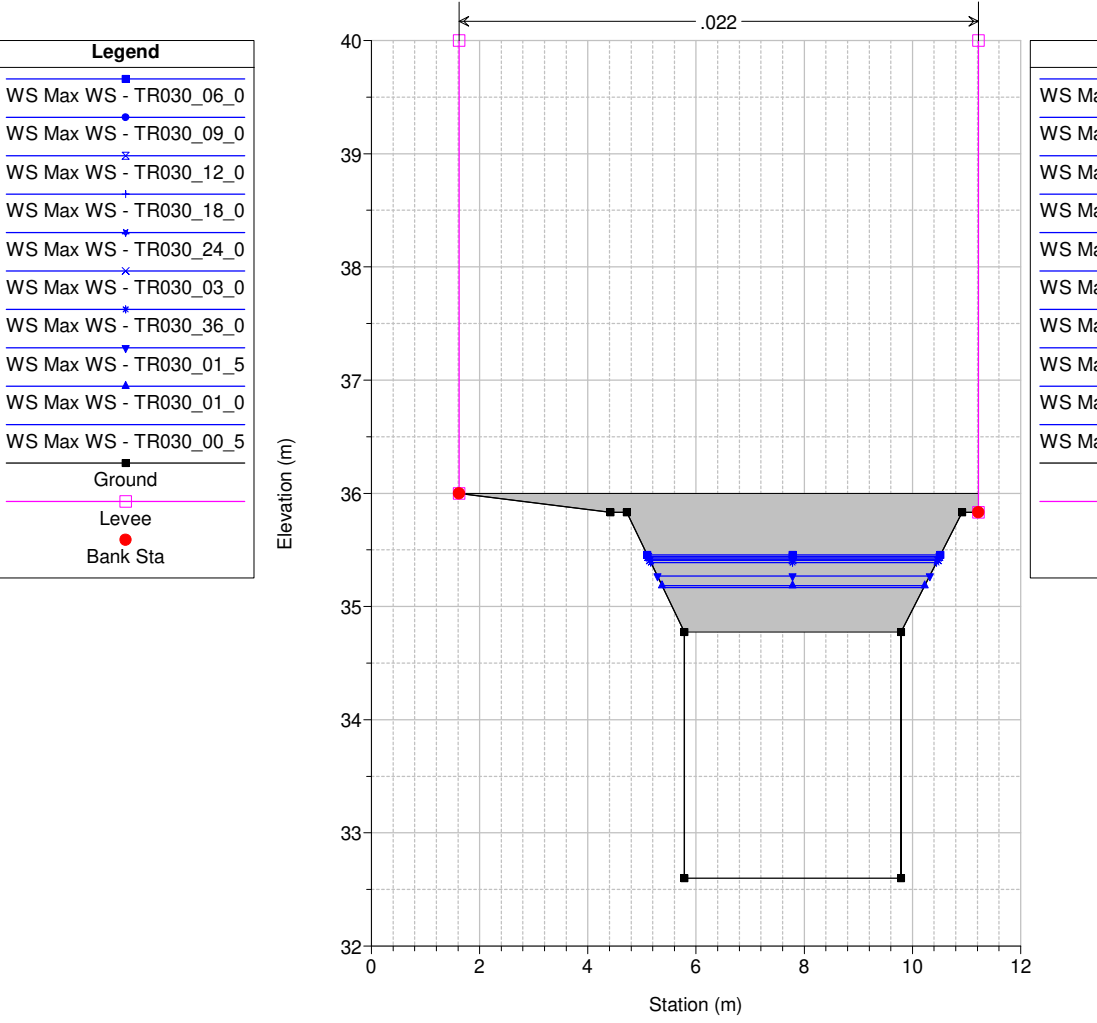

Studio Scandicci Torrenti Greve-Vingone
River = Fosso Rigone Reach = Rigone 01 RS = 7.5 BR

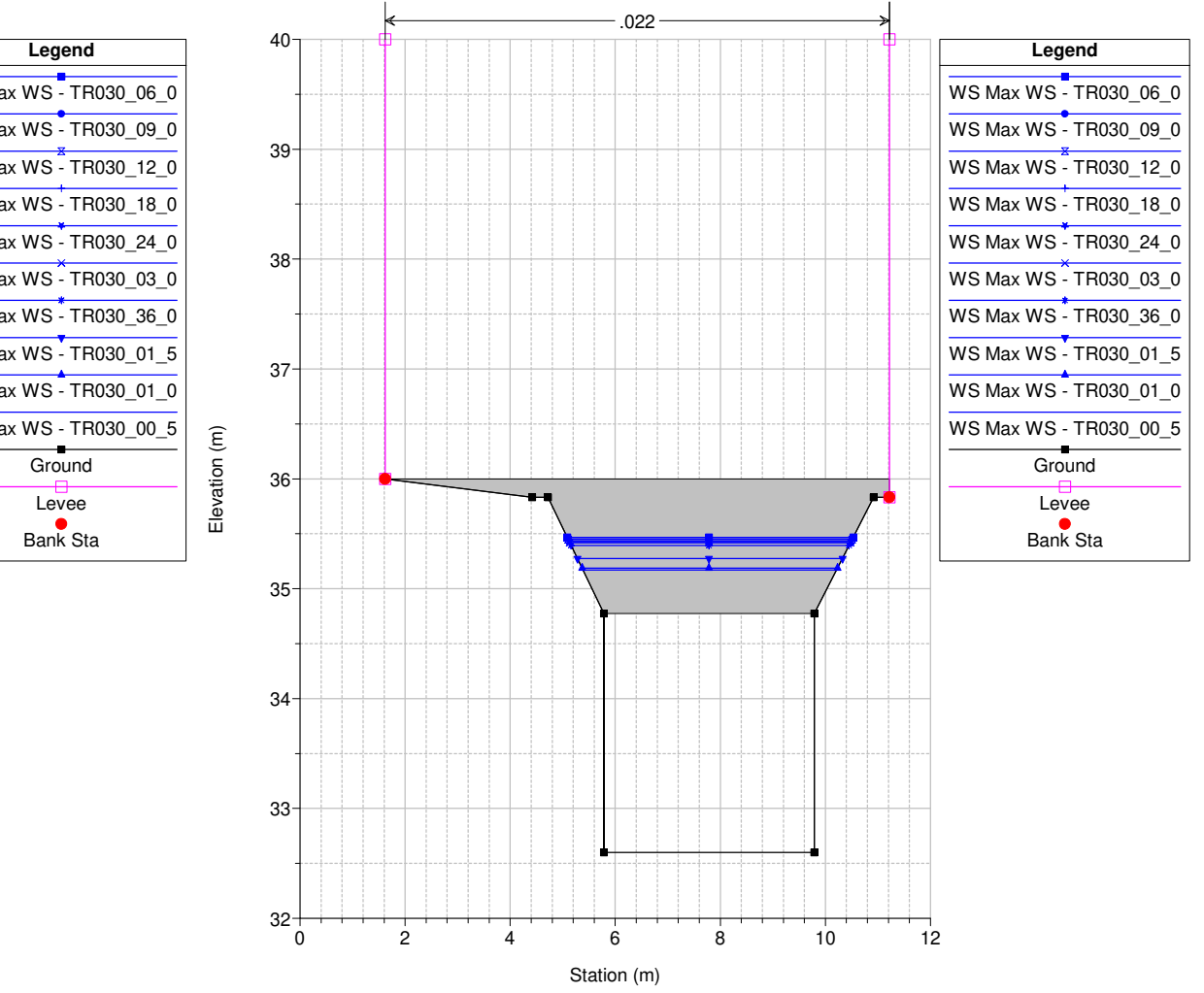

Studio Scandicci Torrenti Greve-Vingone
River = Fosso Rigone Reach = Rigone 01 RS = 7 DO1033_C

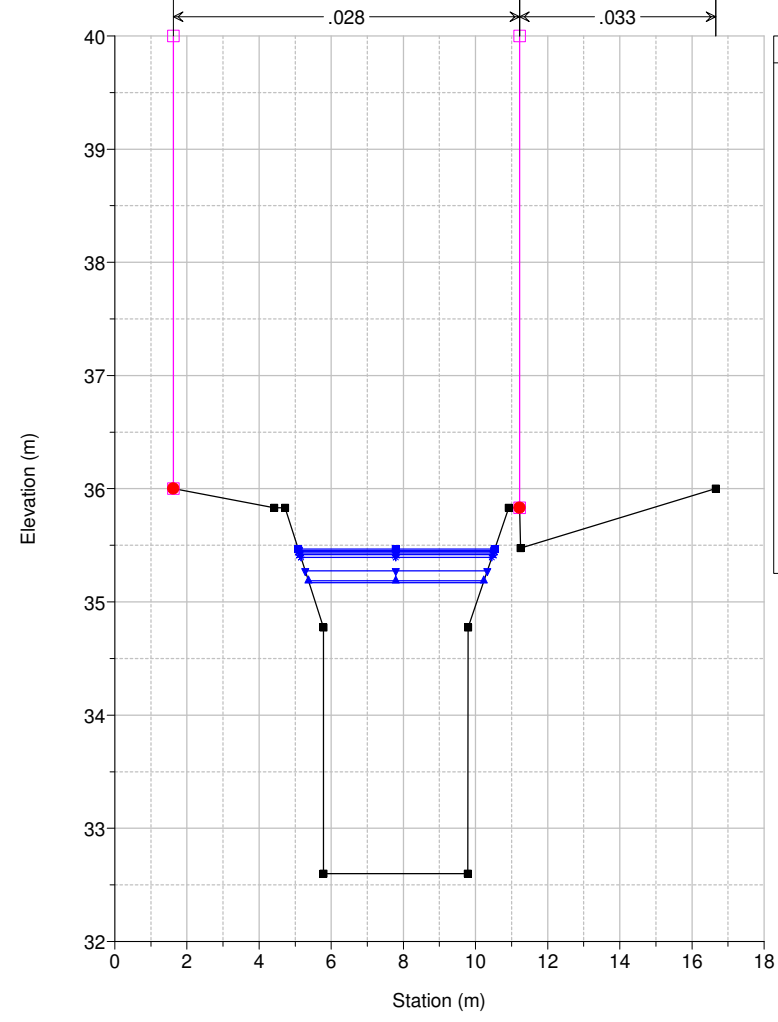

Studio Scandicci Torrenti Greve-Vingone
River = Fosso Rigone Reach = Rigone 01 RS = 6 DO1033_D

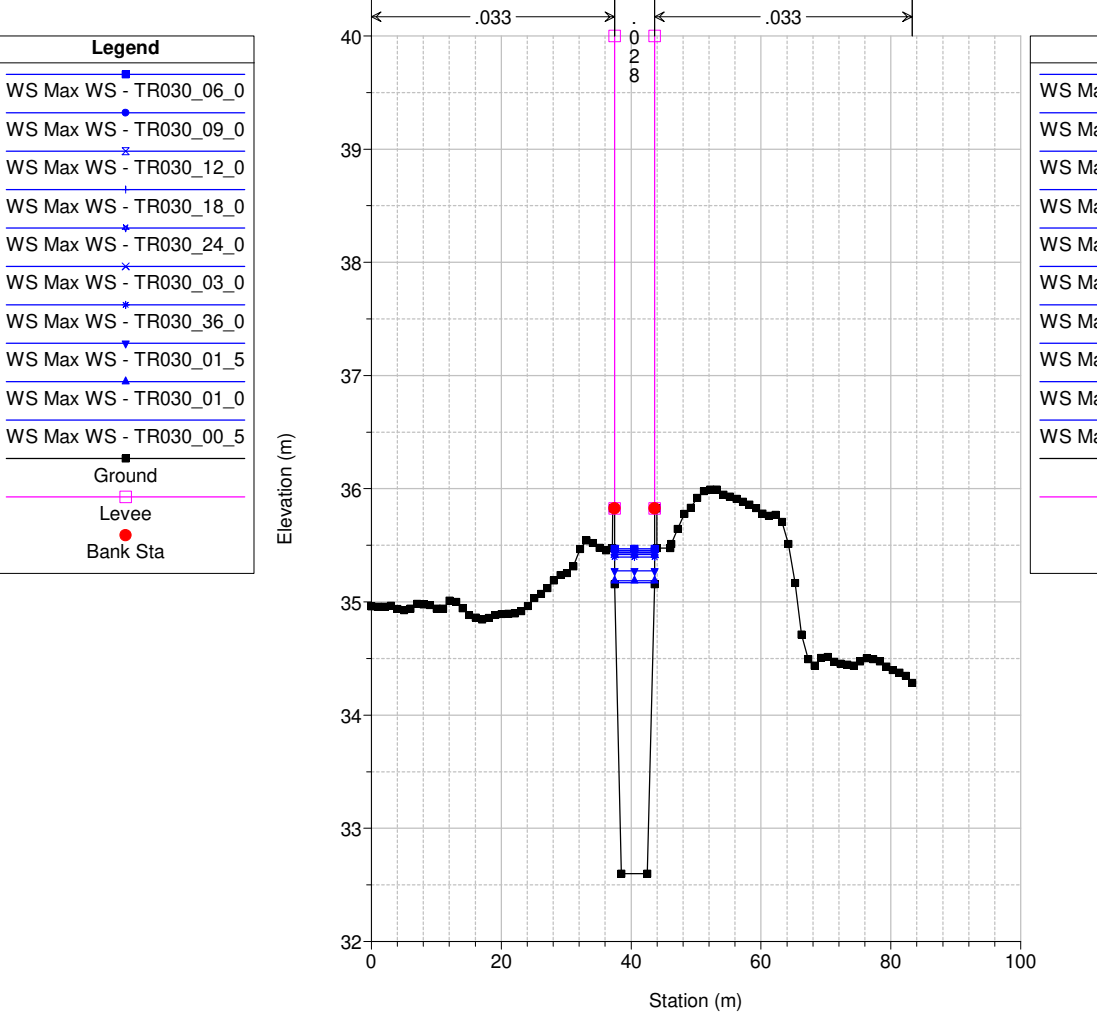

Studio Scandicci Torrenti Greve-Vingone
River = Fosso Rigone Reach = Rigone 01 RS = 5 DO1034_A

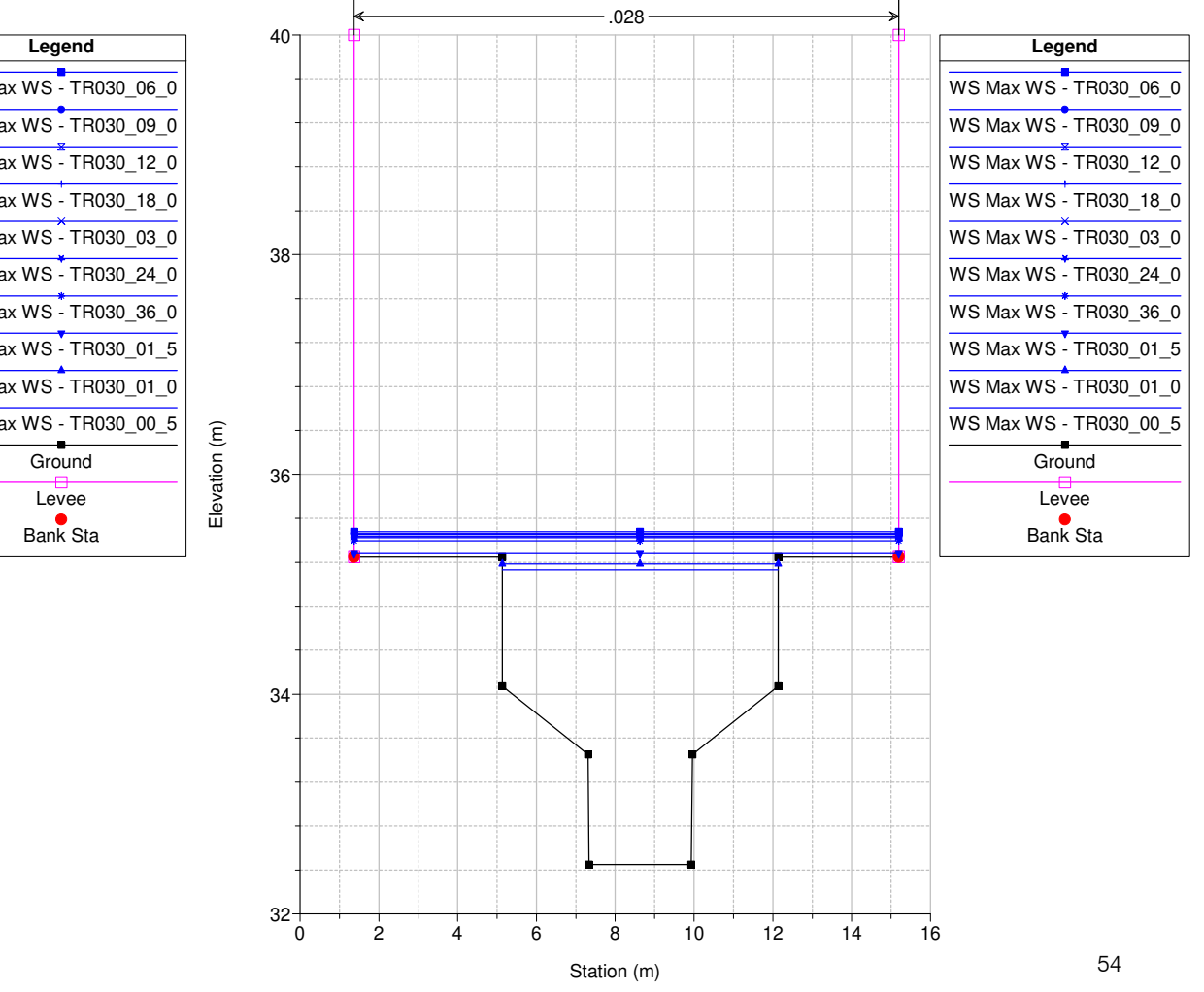

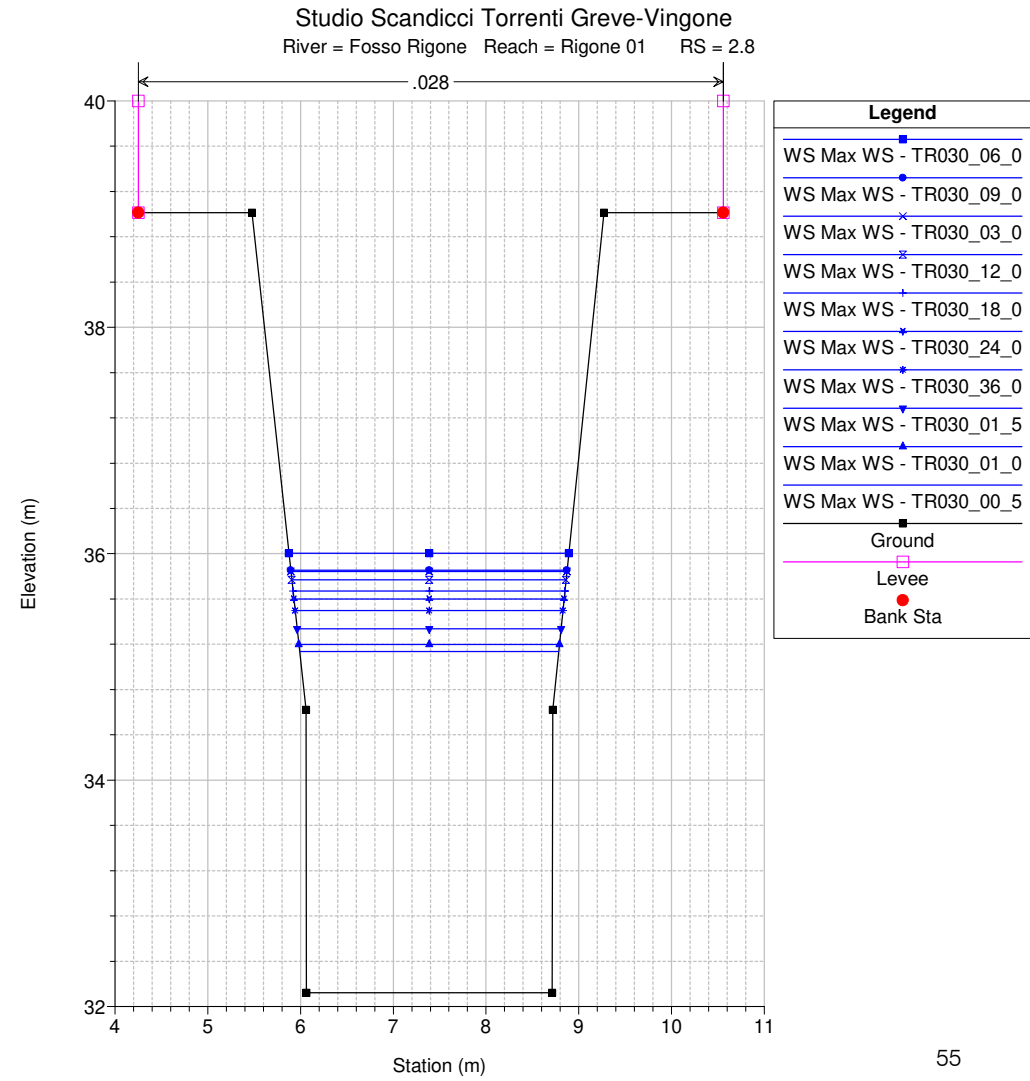
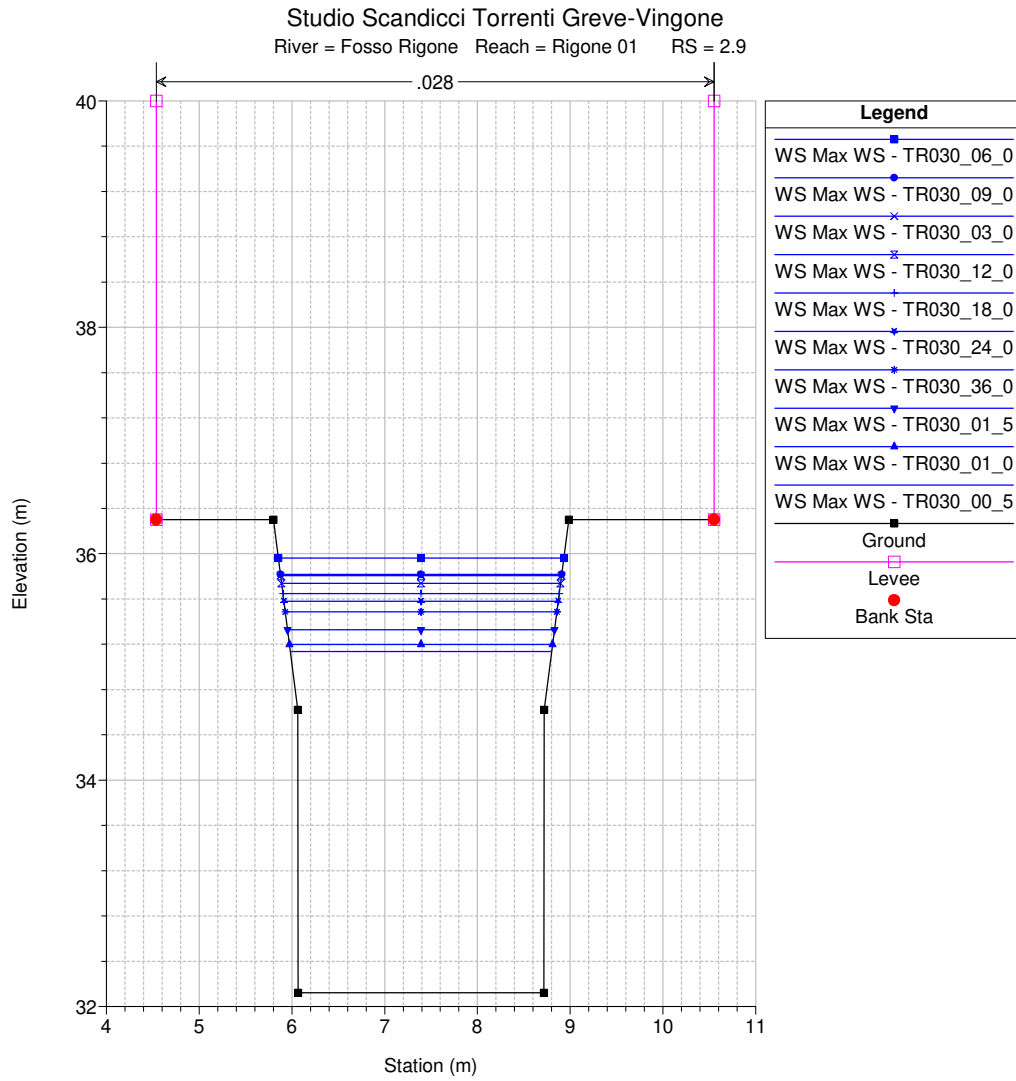
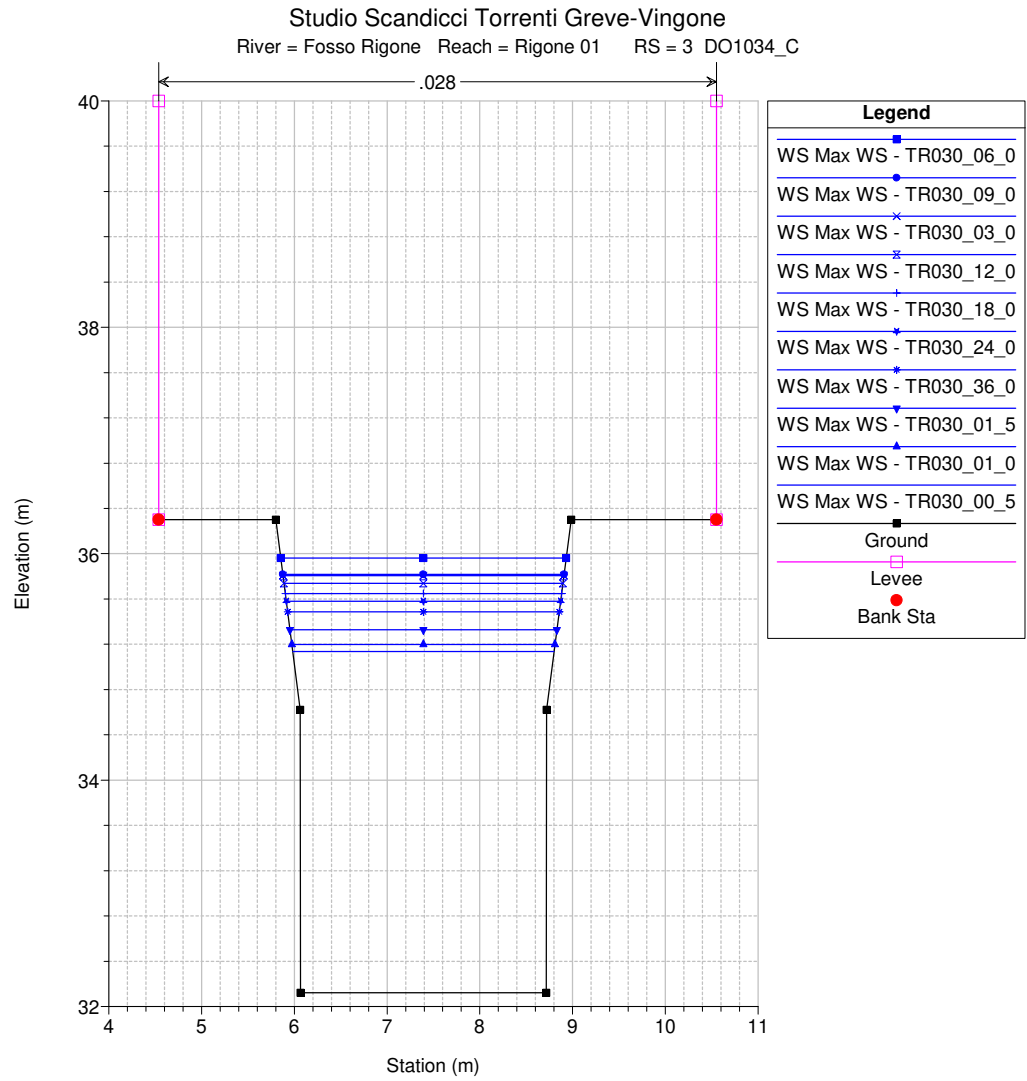
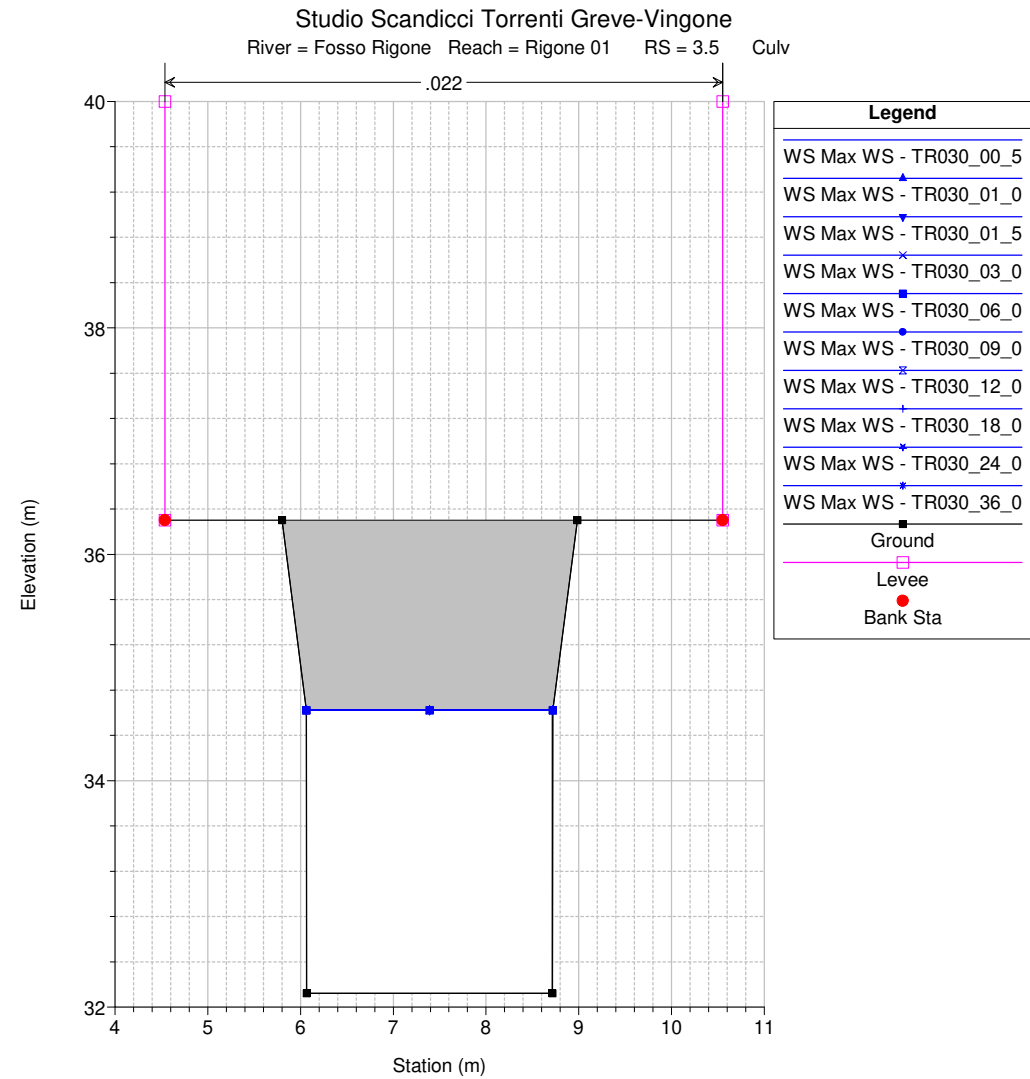
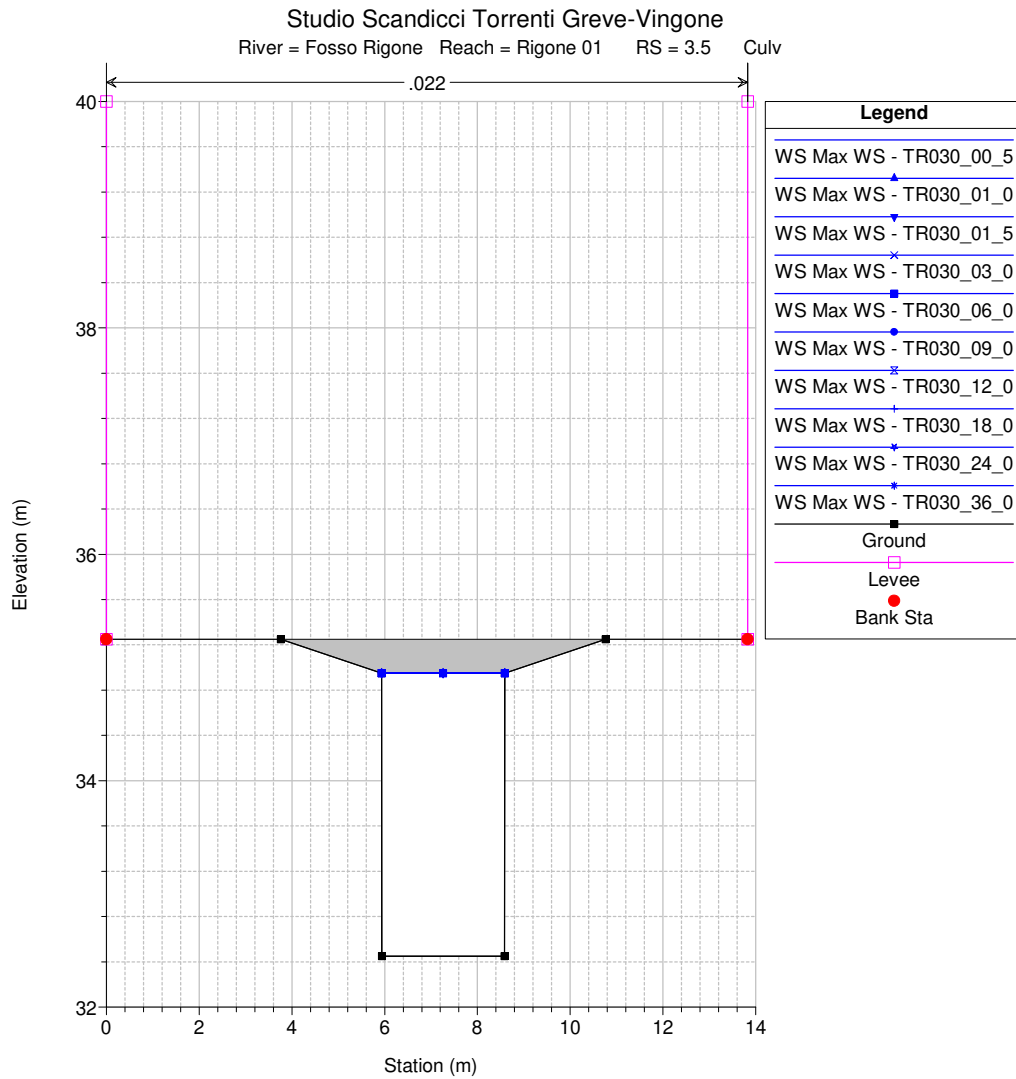
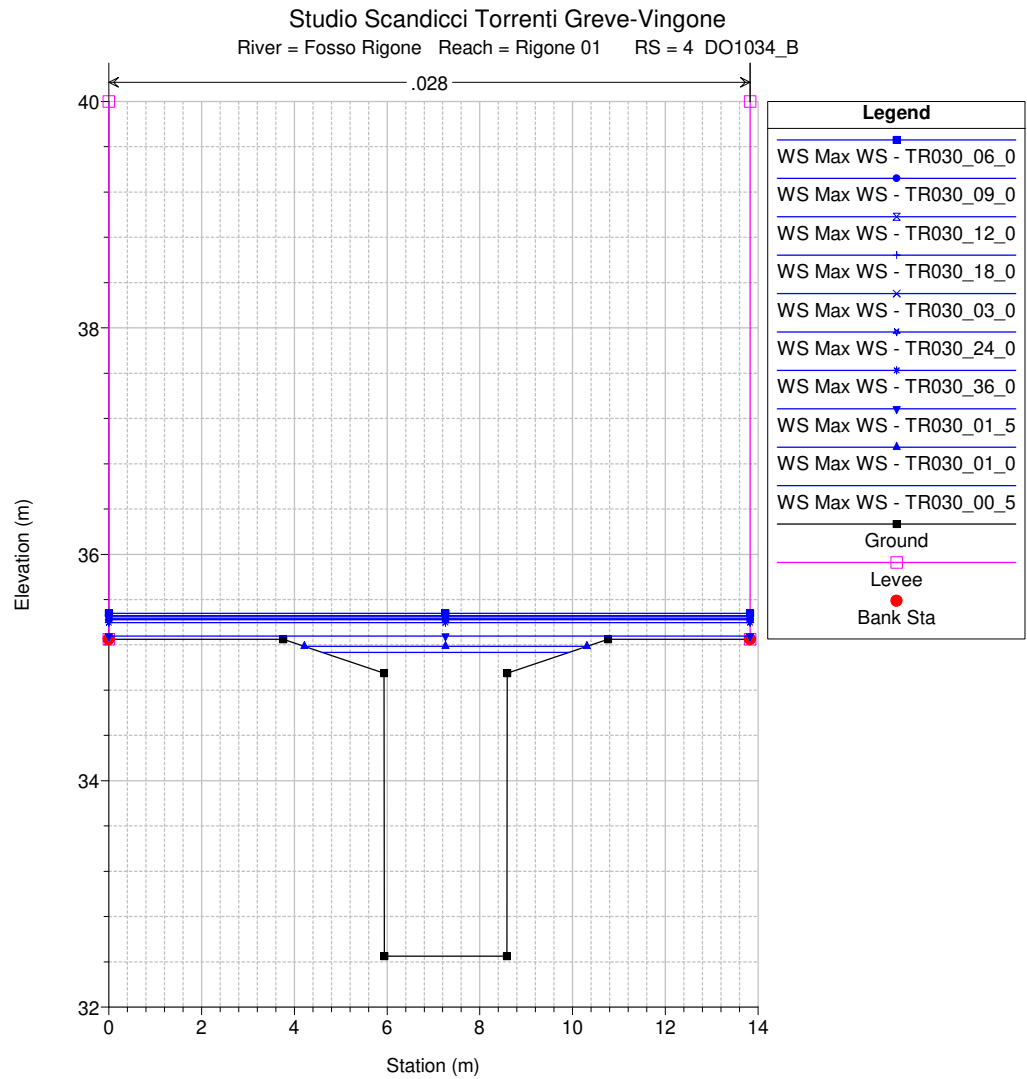

Studio Scandicci Torrenti Greve-Vingone
River = Fosso Rigone Reach = Rigone 01 RS = 2 DO1034_D

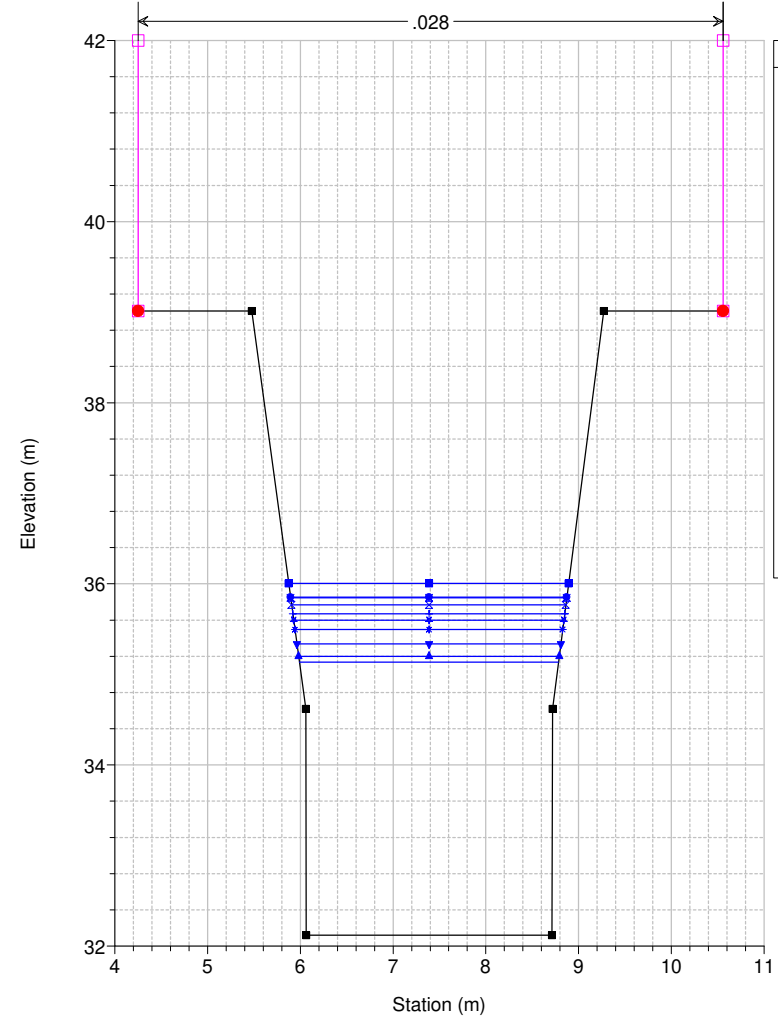

- Legend**
- WS Max WS - TR030_06_0
 - WS Max WS - TR030_09_0
 - WS Max WS - TR030_03_0
 - WS Max WS - TR030_12_0
 - WS Max WS - TR030_18_0
 - WS Max WS - TR030_24_0
 - WS Max WS - TR030_36_0
 - WS Max WS - TR030_01_5
 - WS Max WS - TR030_01_0
 - WS Max WS - TR030_00_5
 - Ground
 - Levee
 - Bank Sta

Studio Scandicci Torrenti Greve-Vingone
River = Fosso Rigone Reach = Rigone 01 RS = 1.75 IS

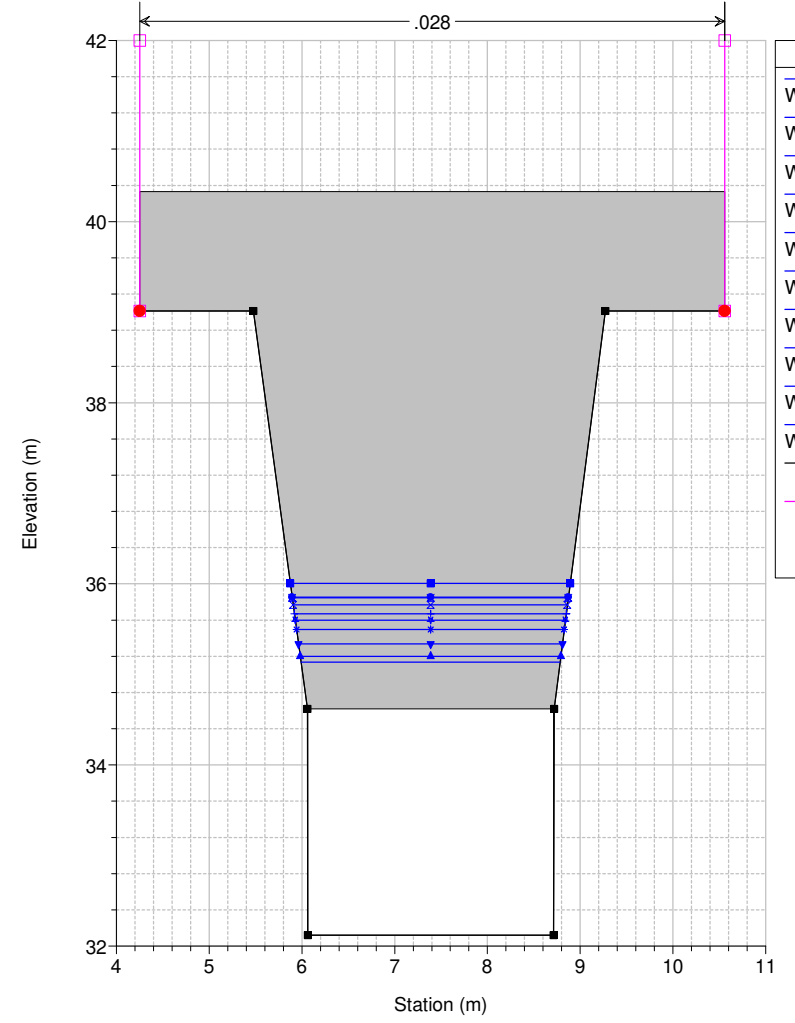

- Legend**
- WS Max WS - TR030_06_0
 - WS Max WS - TR030_09_0
 - WS Max WS - TR030_03_0
 - WS Max WS - TR030_12_0
 - WS Max WS - TR030_18_0
 - WS Max WS - TR030_24_0
 - WS Max WS - TR030_36_0
 - WS Max WS - TR030_01_5
 - WS Max WS - TR030_01_0
 - WS Max WS - TR030_00_5
 - Ground
 - Levee
 - Bank Sta

Studio Scandicci Torrenti Greve-Vingone
River = Fosso Rigone Reach = Rigone 01 RS = 1.4

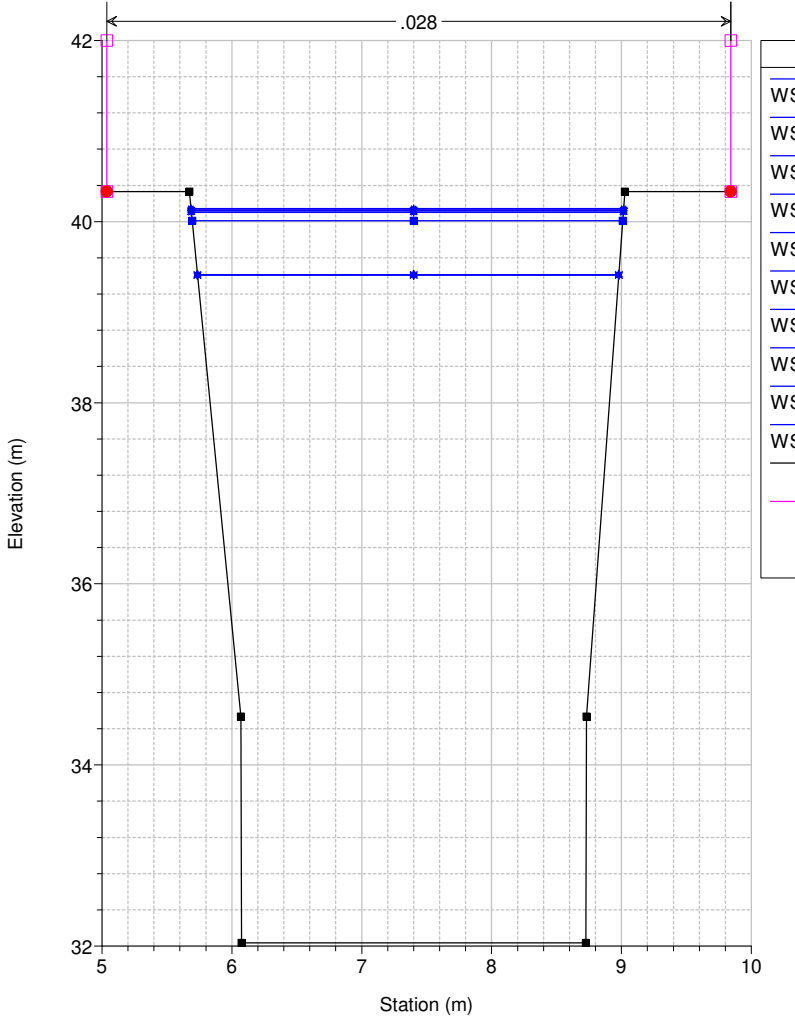

- Legend**
- WS Max WS - TR030_18_0
 - WS Max WS - TR030_24_0
 - WS Max WS - TR030_09_0
 - WS Max WS - TR030_12_0
 - WS Max WS - TR030_36_0
 - WS Max WS - TR030_06_0
 - WS Max WS - TR030_03_0
 - WS Max WS - TR030_00_5
 - WS Max WS - TR030_01_0
 - WS Max WS - TR030_01_5
 - Ground
 - Levee
 - Bank Sta

Studio Scandicci Torrenti Greve-Vingone
River = Fosso Rigone Reach = Rigone 01 RS = 1 DO1034_E

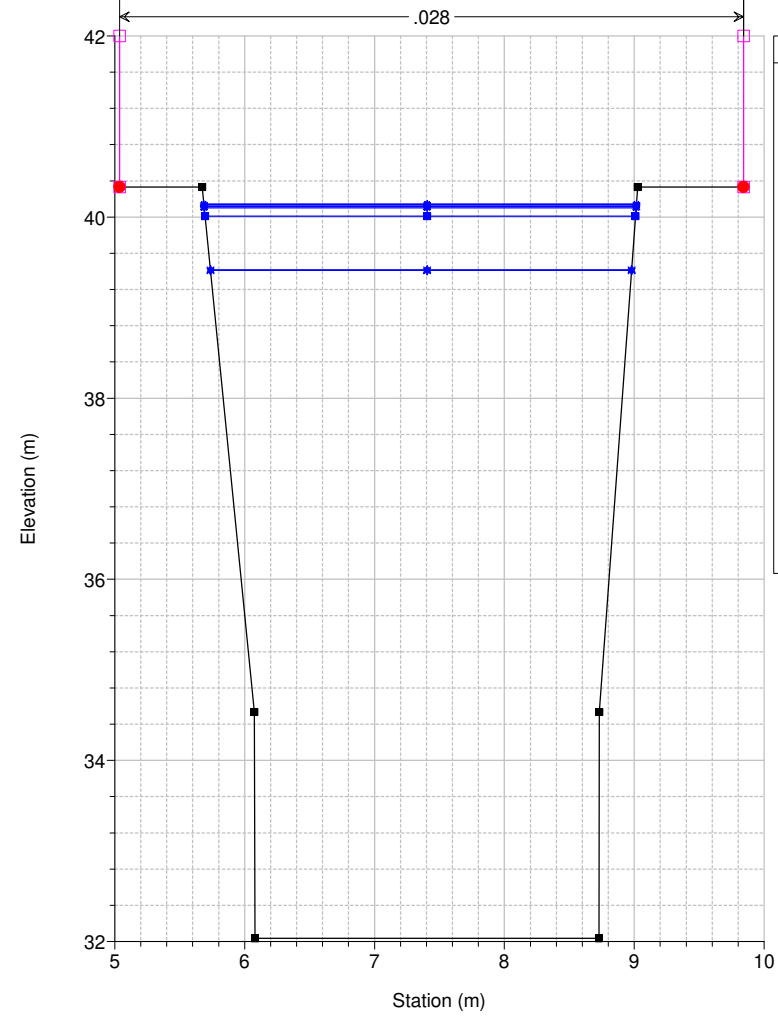

- Legend**
- WS Max WS - TR030_18_0
 - WS Max WS - TR030_24_0
 - WS Max WS - TR030_09_0
 - WS Max WS - TR030_12_0
 - WS Max WS - TR030_36_0
 - WS Max WS - TR030_06_0
 - WS Max WS - TR030_03_0
 - WS Max WS - TR030_00_5
 - WS Max WS - TR030_01_0
 - WS Max WS - TR030_01_5
 - Ground
 - Levee
 - Bank Sta

Studio Scandicci Torrenti Greve-Vingone
River = Fosso Rigone Reach = Rigone 01 RS = 0.5 AR0520

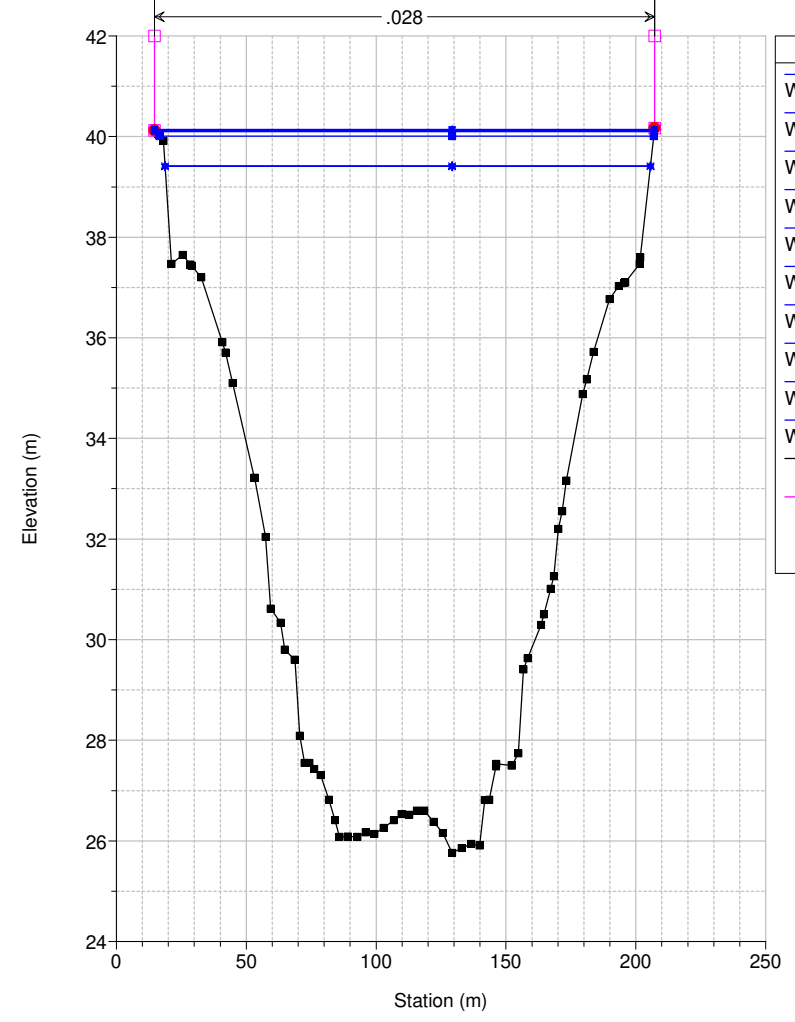

- Legend**
- WS Max WS - TR030_18_0
 - WS Max WS - TR030_24_0
 - WS Max WS - TR030_09_0
 - WS Max WS - TR030_12_0
 - WS Max WS - TR030_36_0
 - WS Max WS - TR030_06_0
 - WS Max WS - TR030_03_0
 - WS Max WS - TR030_00_5
 - WS Max WS - TR030_01_0
 - WS Max WS - TR030_01_5
 - Ground
 - Levee
 - Bank Sta

Studio Scandicci Torrenti Greve-Vingone
River = Fosso Stagnacci Reach = Stagnacci RS = 7 SR0004_

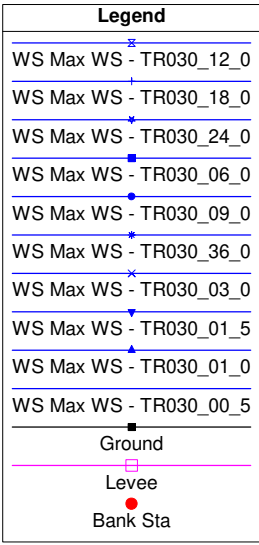
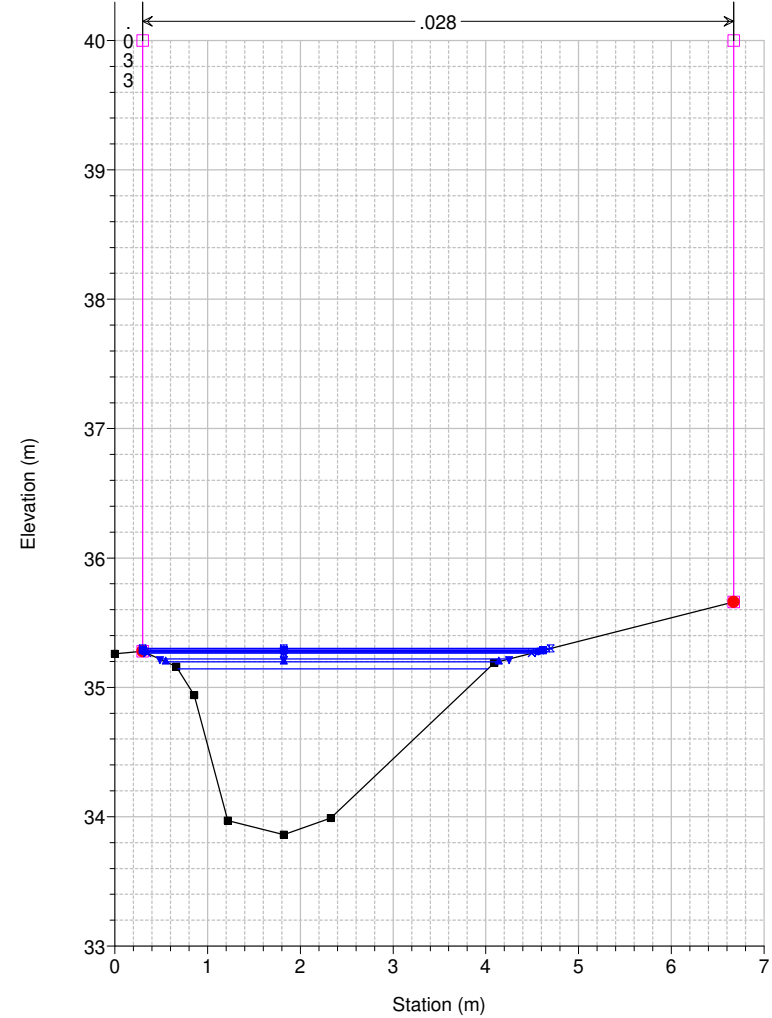

Studio Scandicci Torrenti Greve-Vingone
River = Fosso Stagnacci Reach = Stagnacci RS = 6 SR0003_A

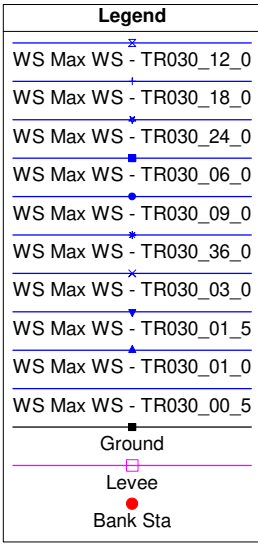
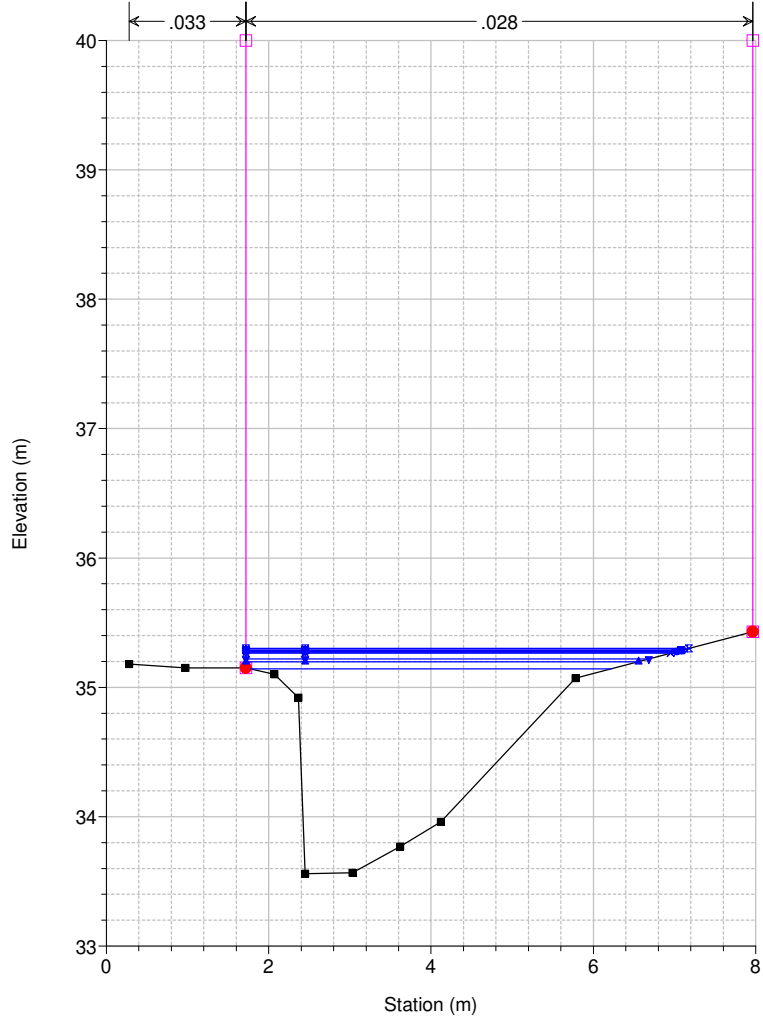

Studio Scandicci Torrenti Greve-Vingone
River = Fosso Stagnacci Reach = Stagnacci RS = 5 SR0003_B

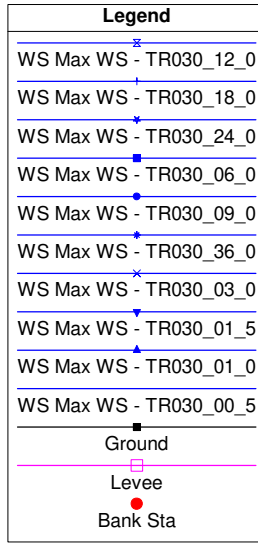
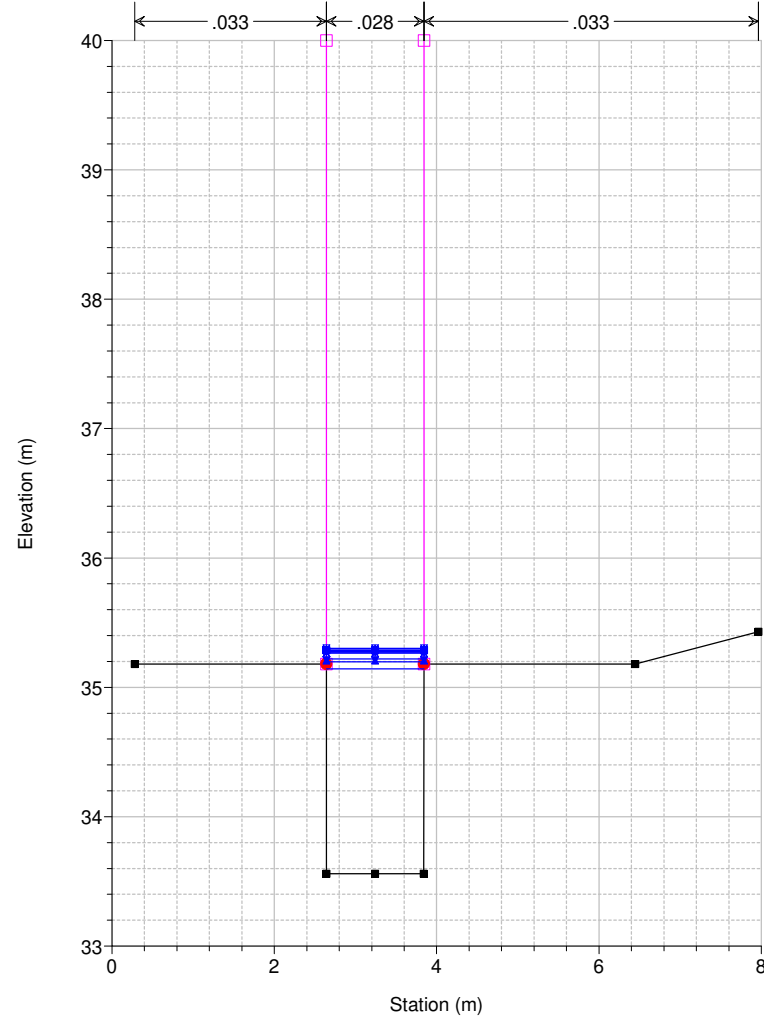

Studio Scandicci Torrenti Greve-Vingone
River = Fosso Stagnacci Reach = Stagnacci RS = 4.5 BR

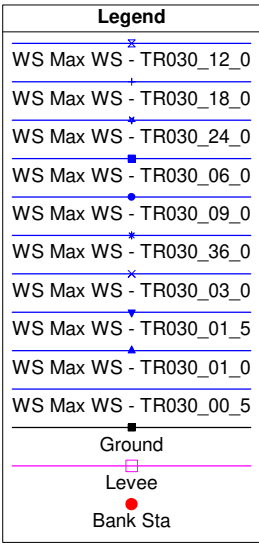
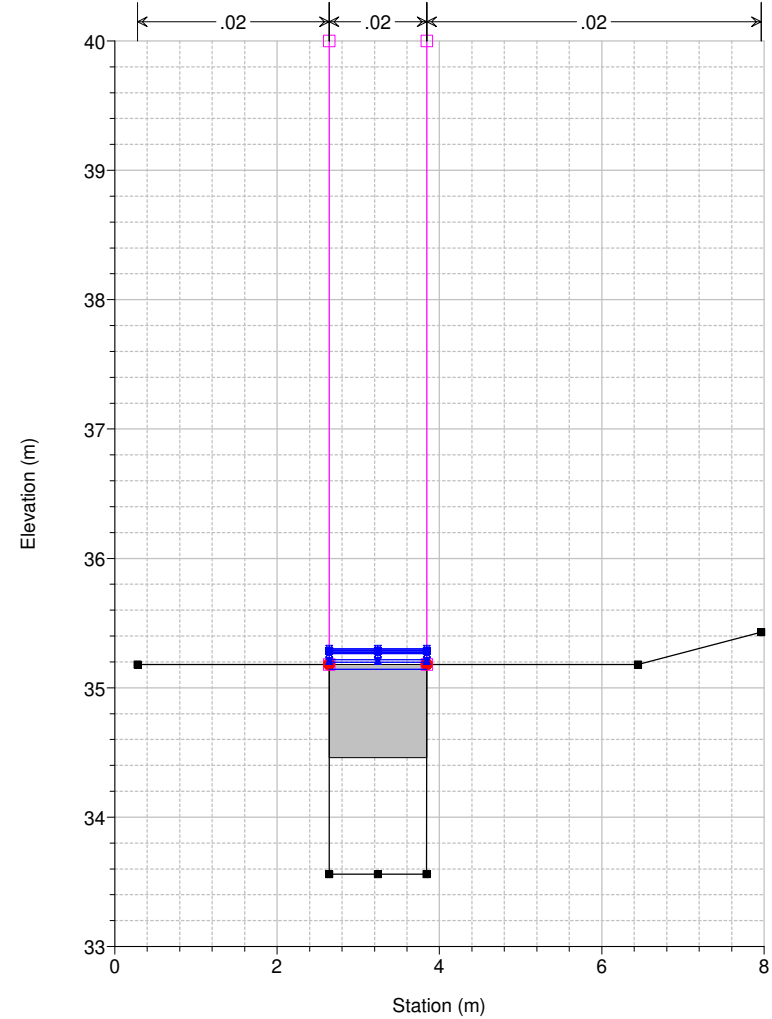

Studio Scandicci Torrenti Greve-Vingone
River = Fosso Stagnacci Reach = Stagnacci RS = 4.5 BR

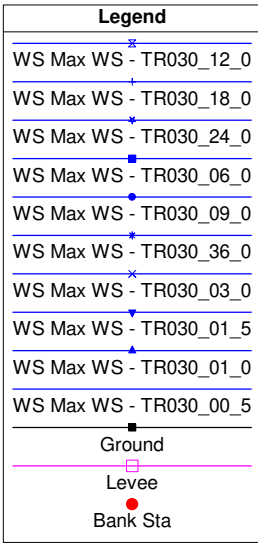
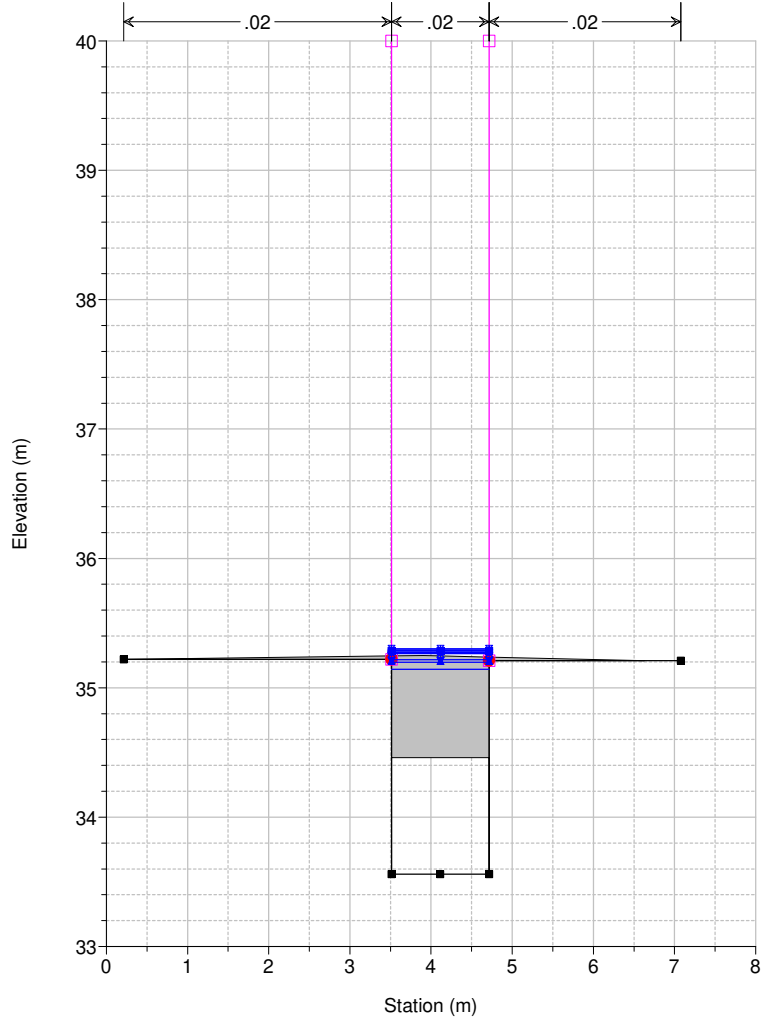

Studio Scandicci Torrenti Greve-Vingone
River = Fosso Stagnacci Reach = Stagnacci RS = 4 SR0003_C

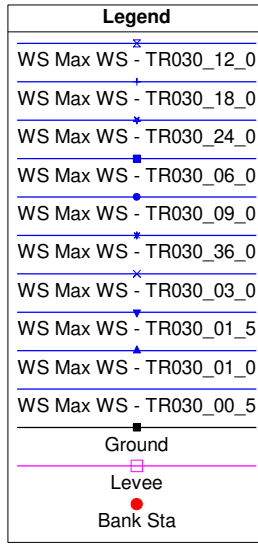
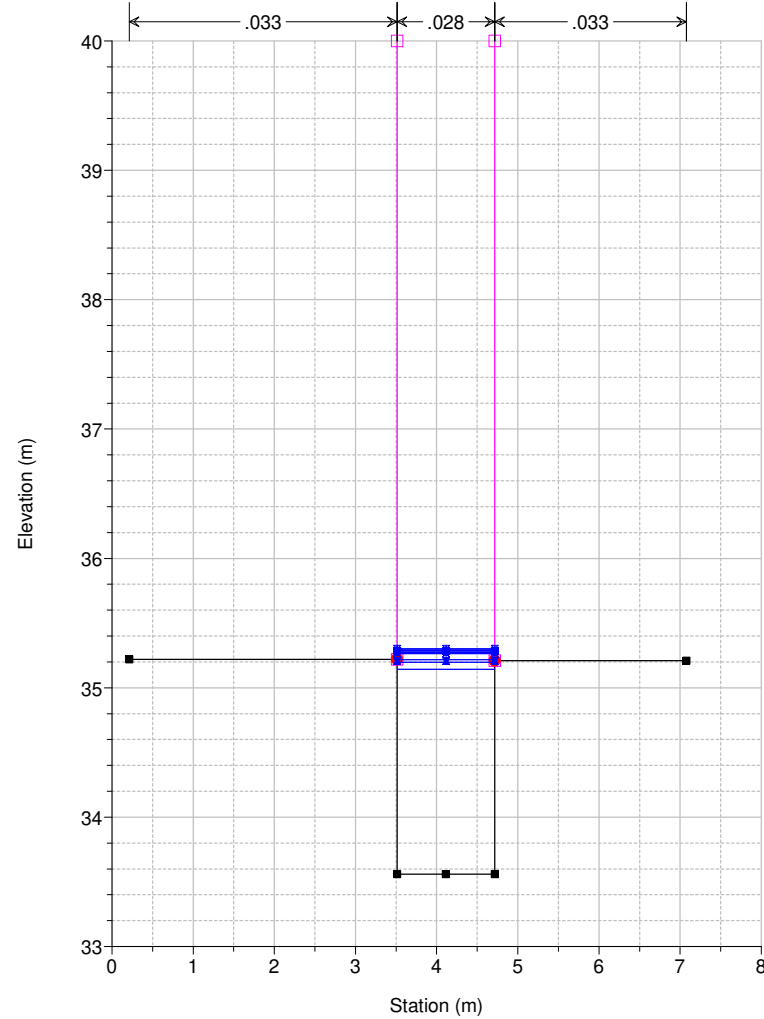

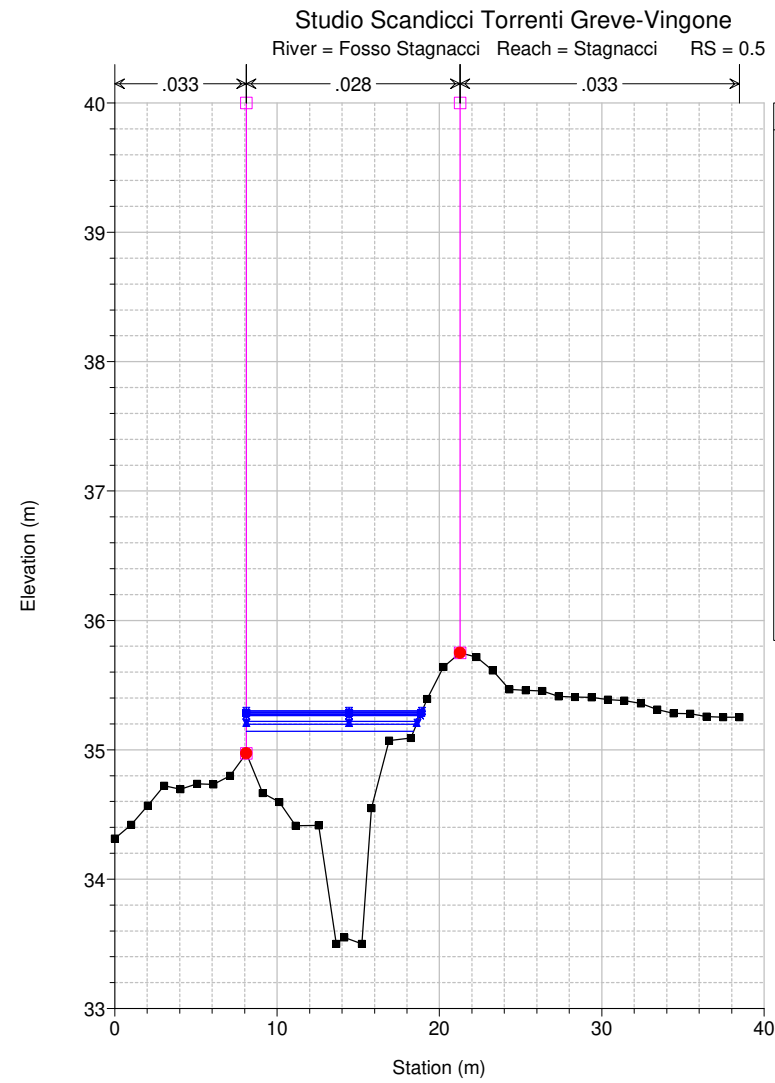
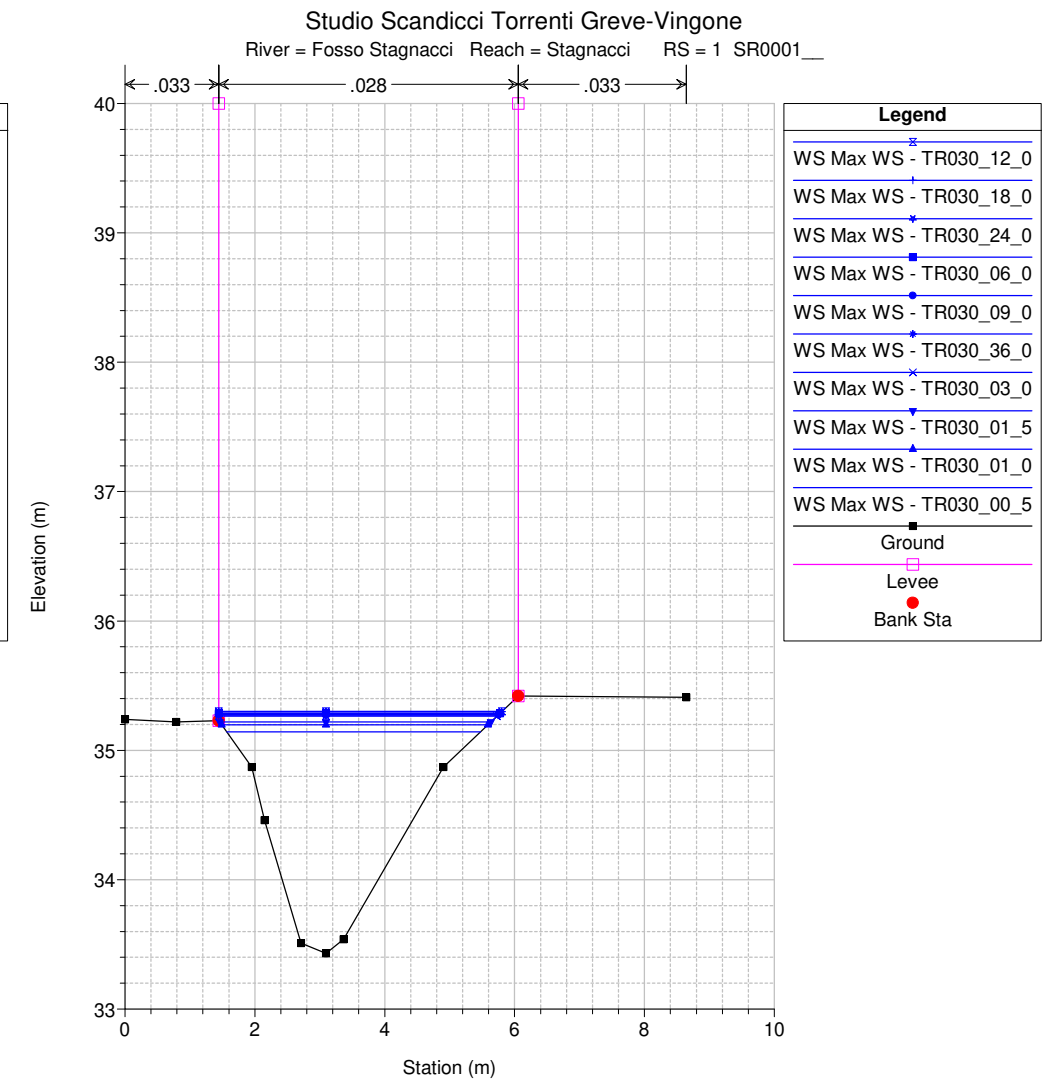
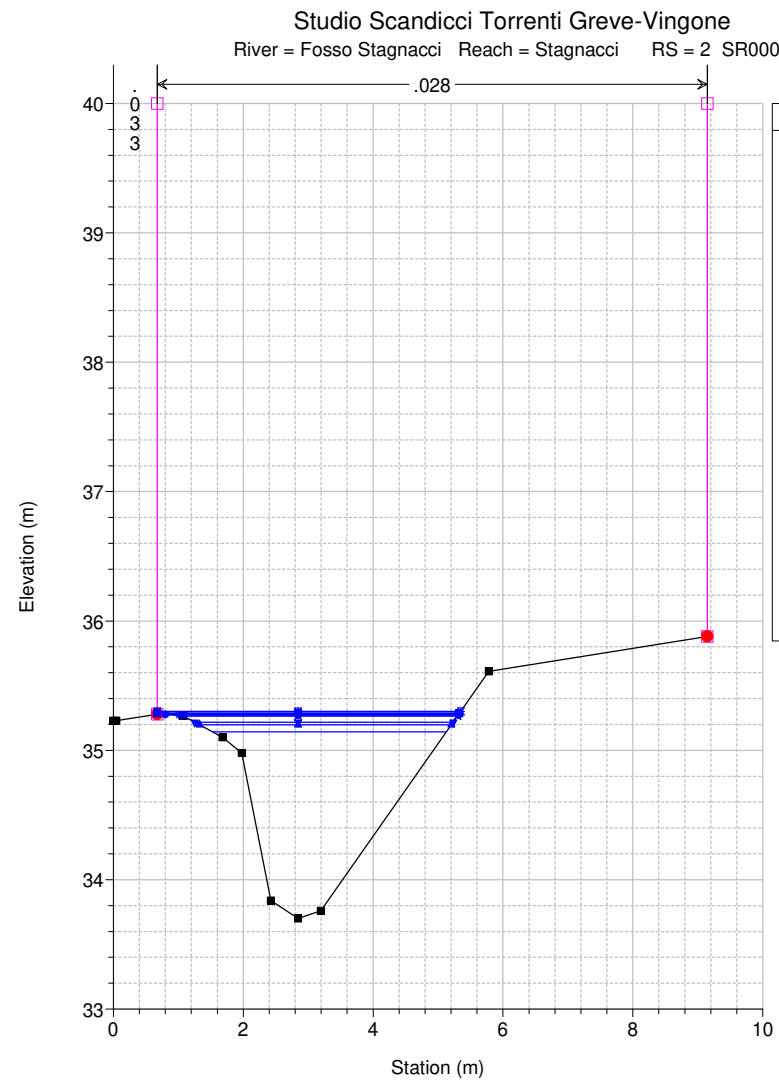
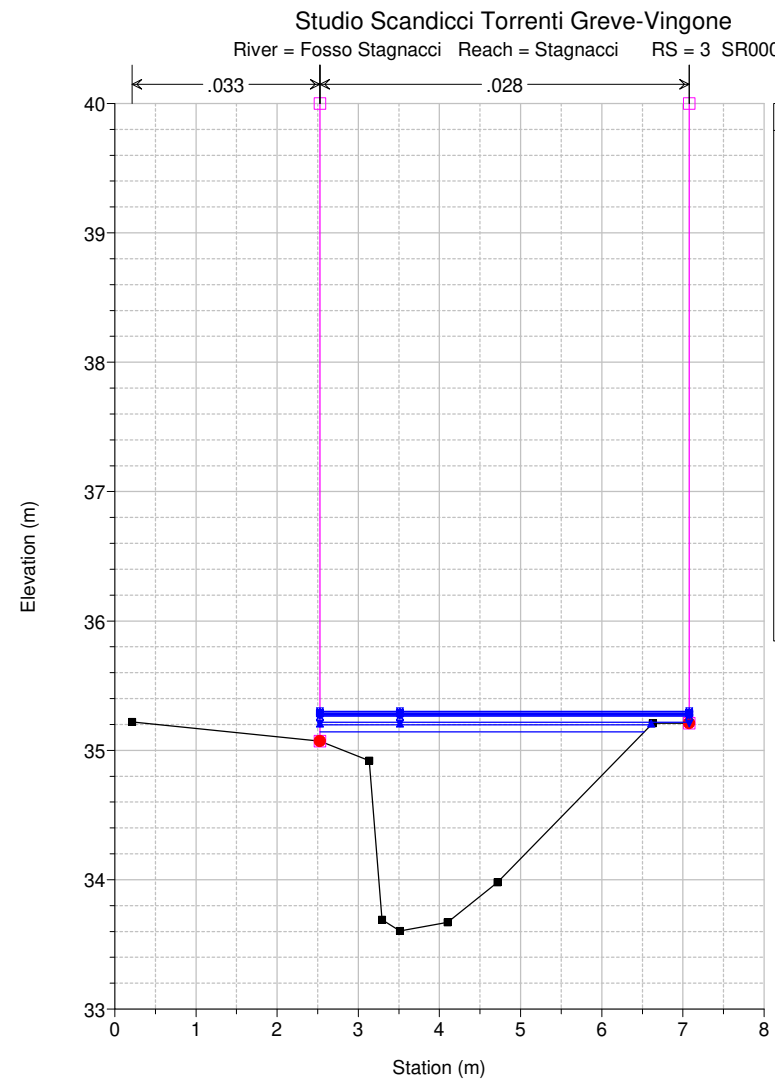

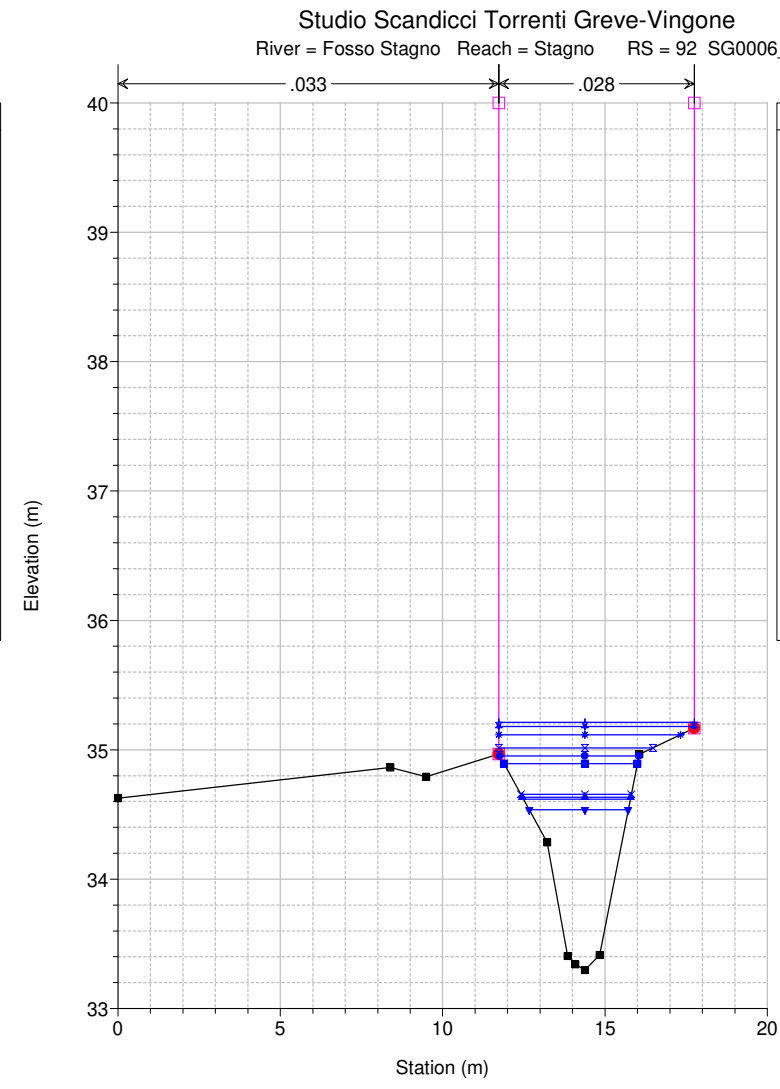
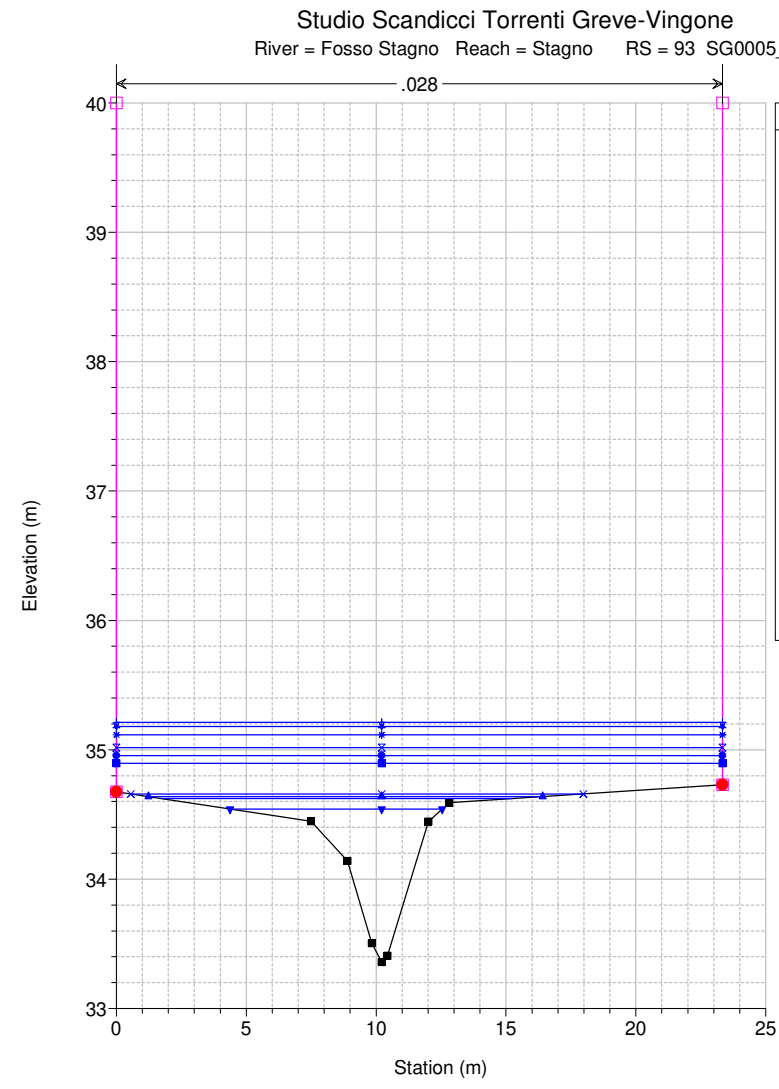
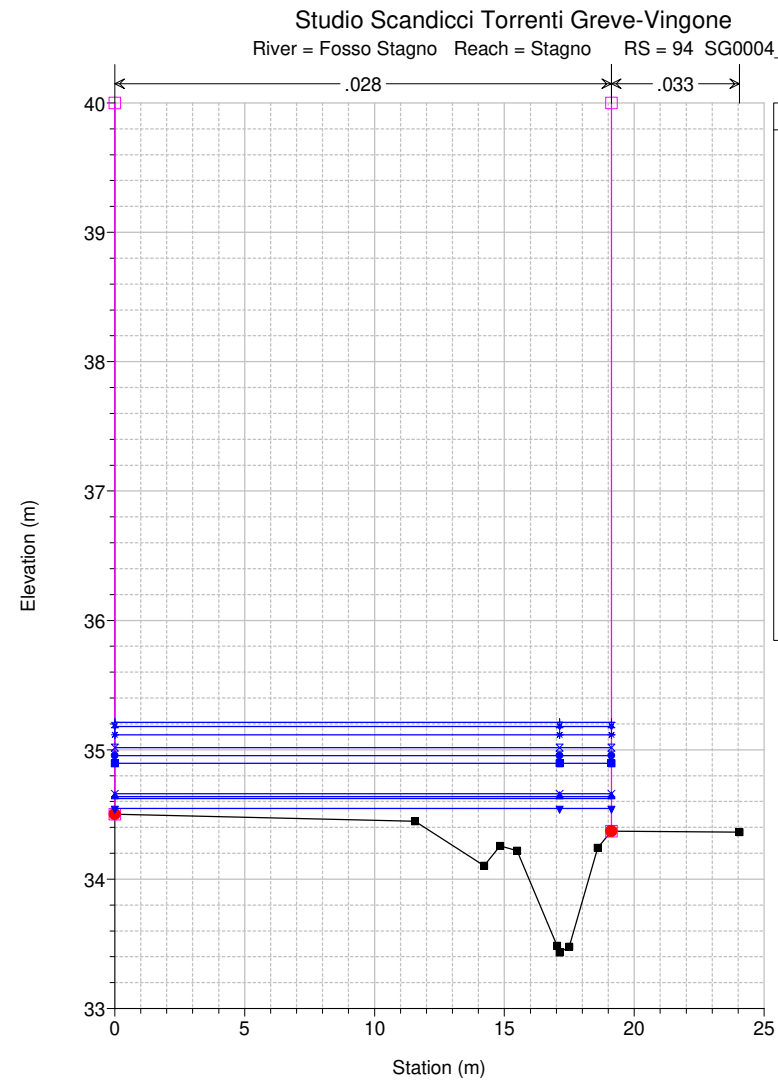
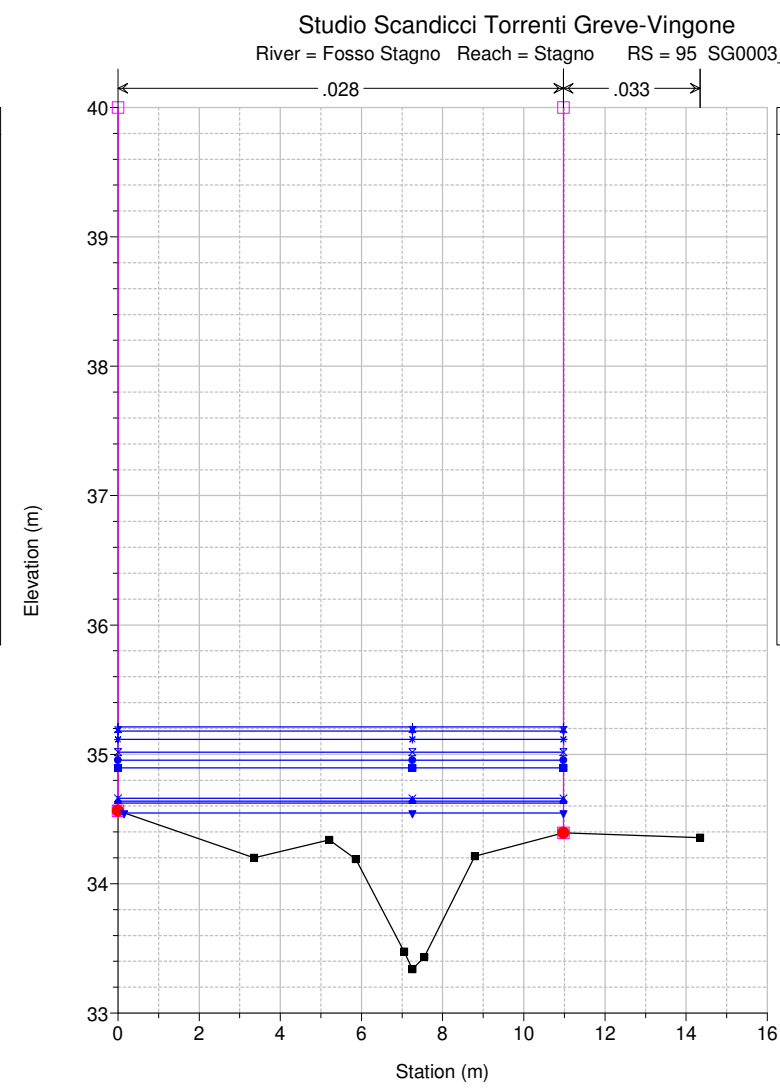
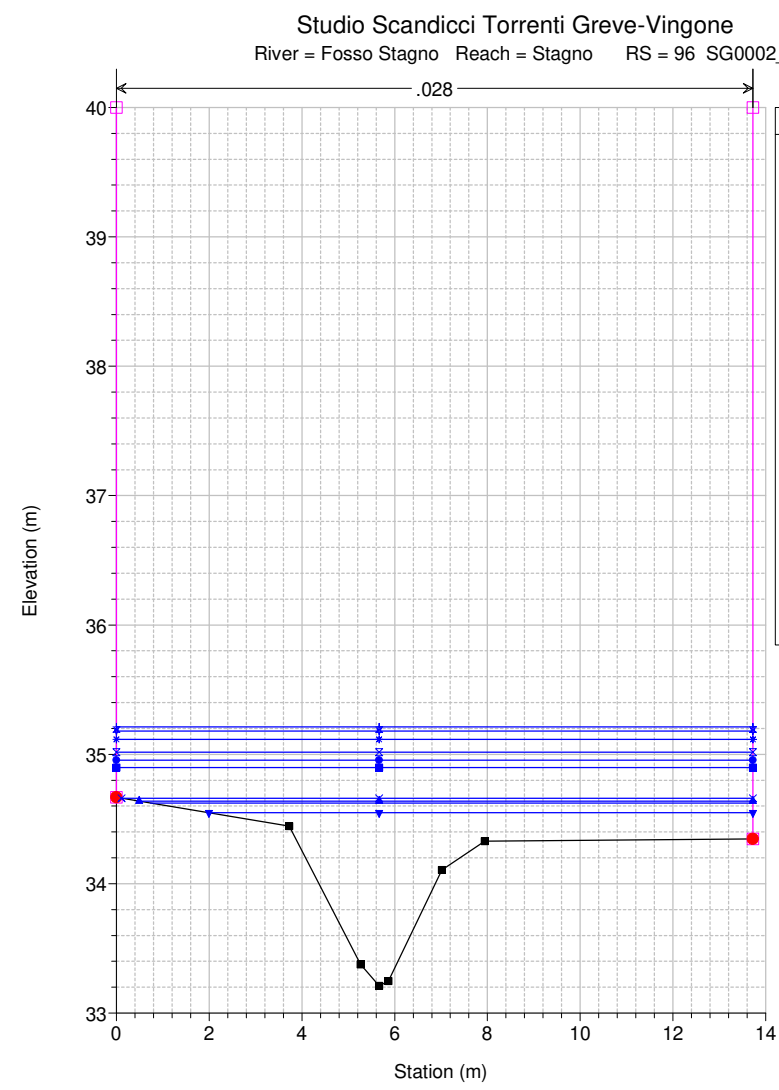
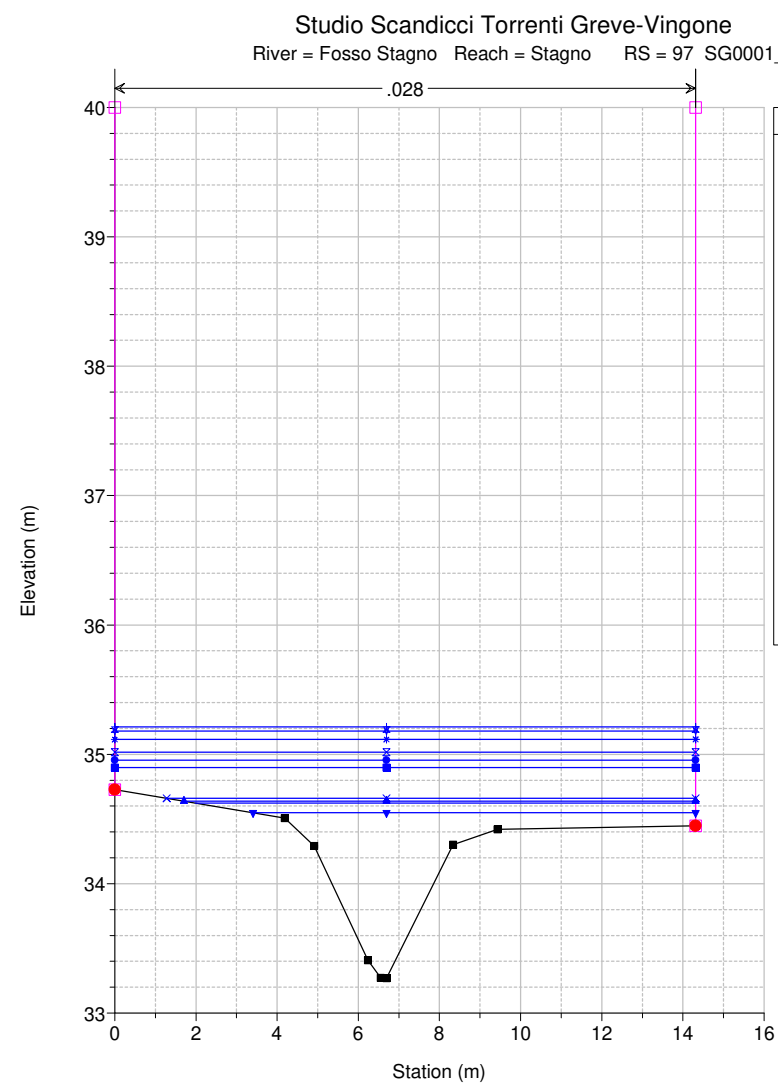

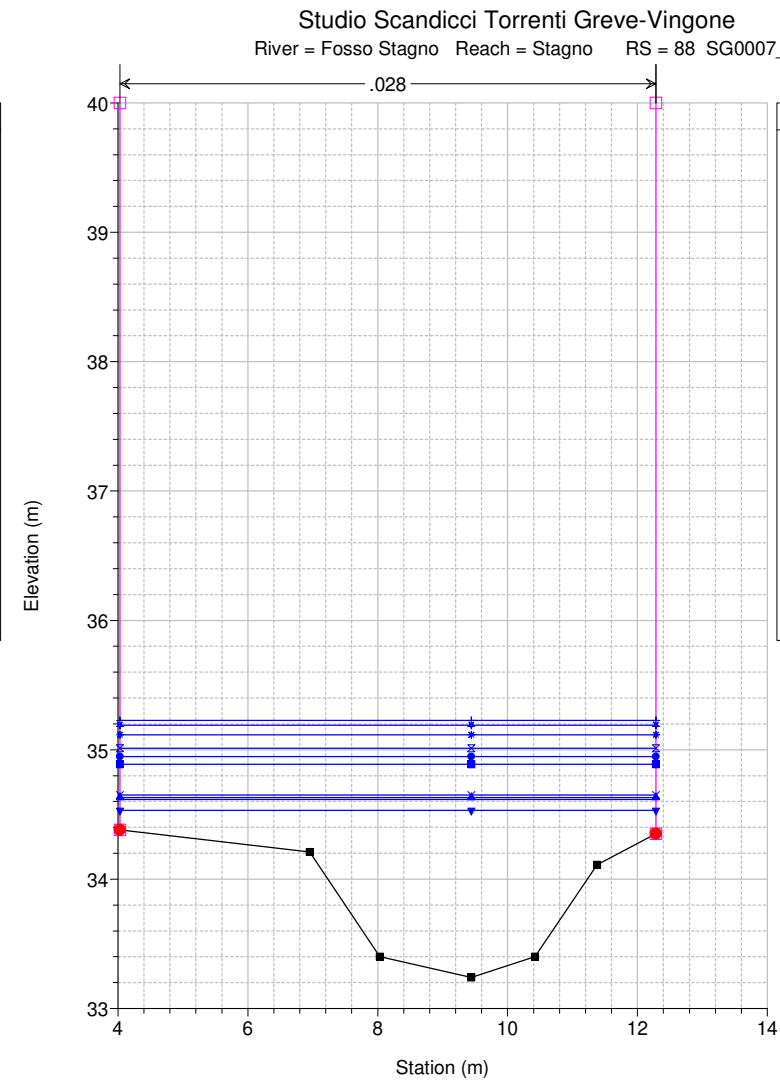
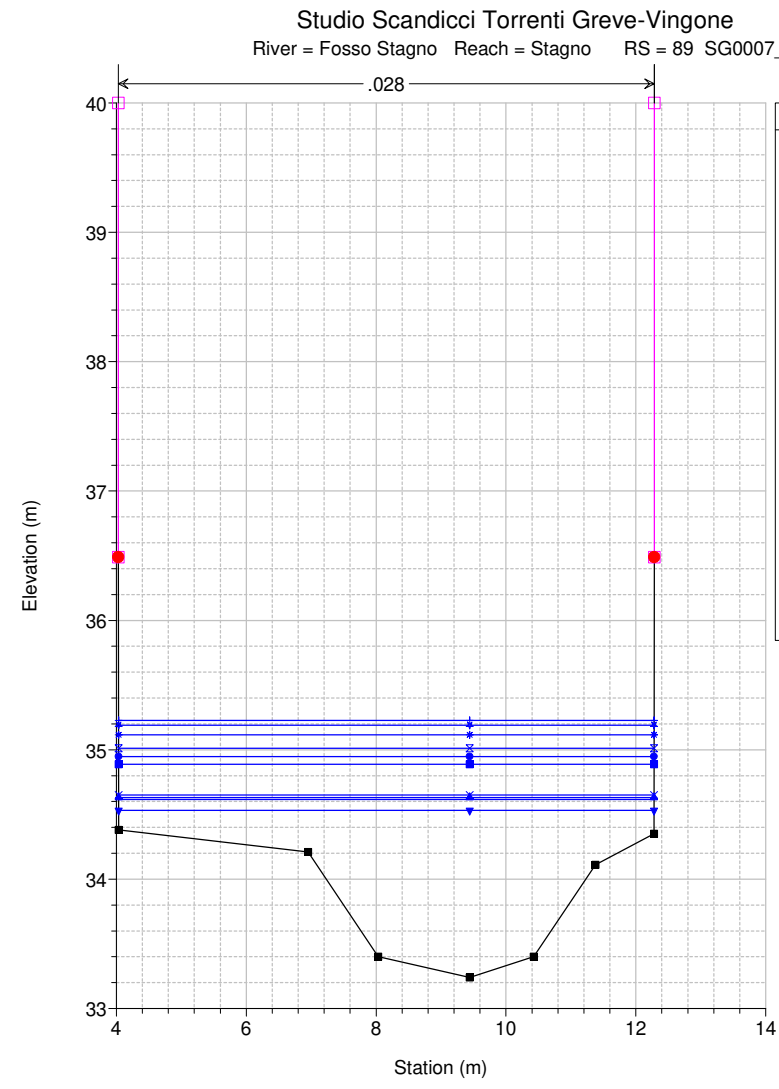
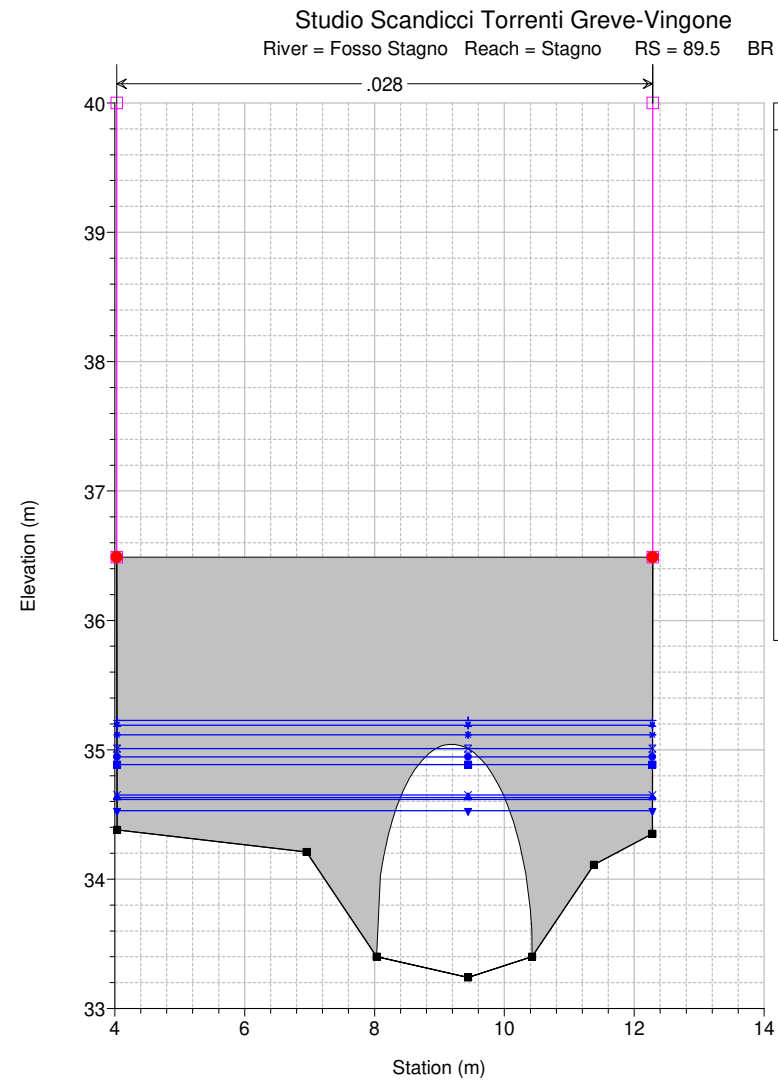
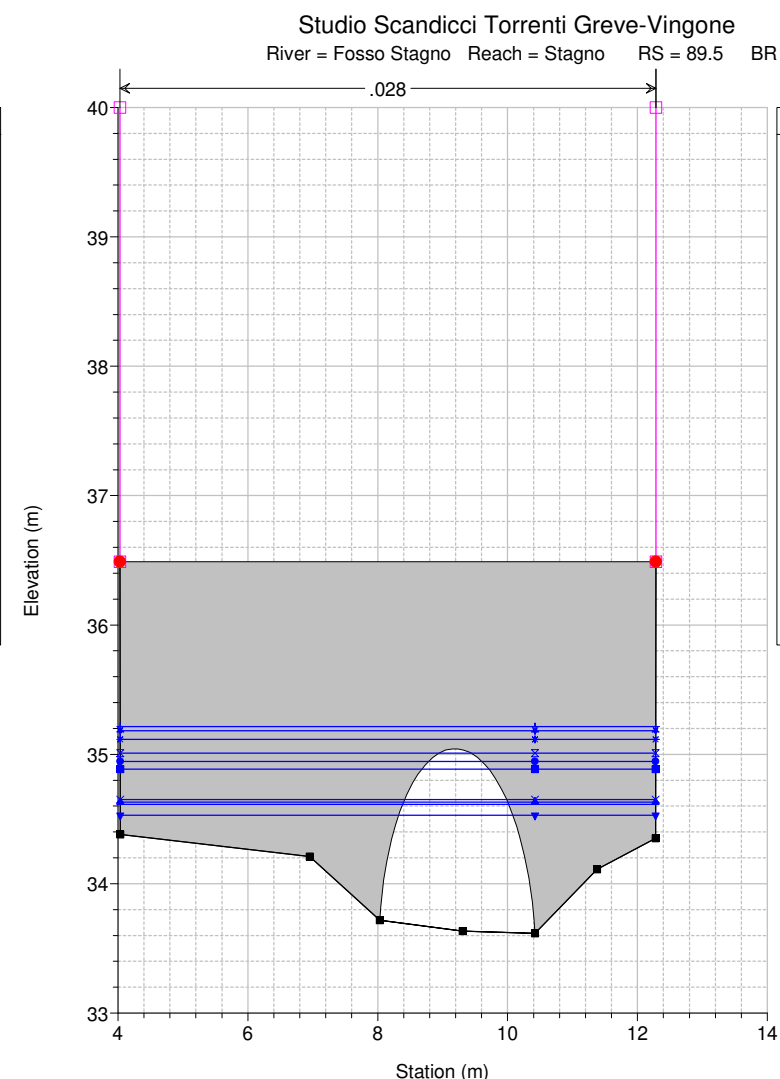
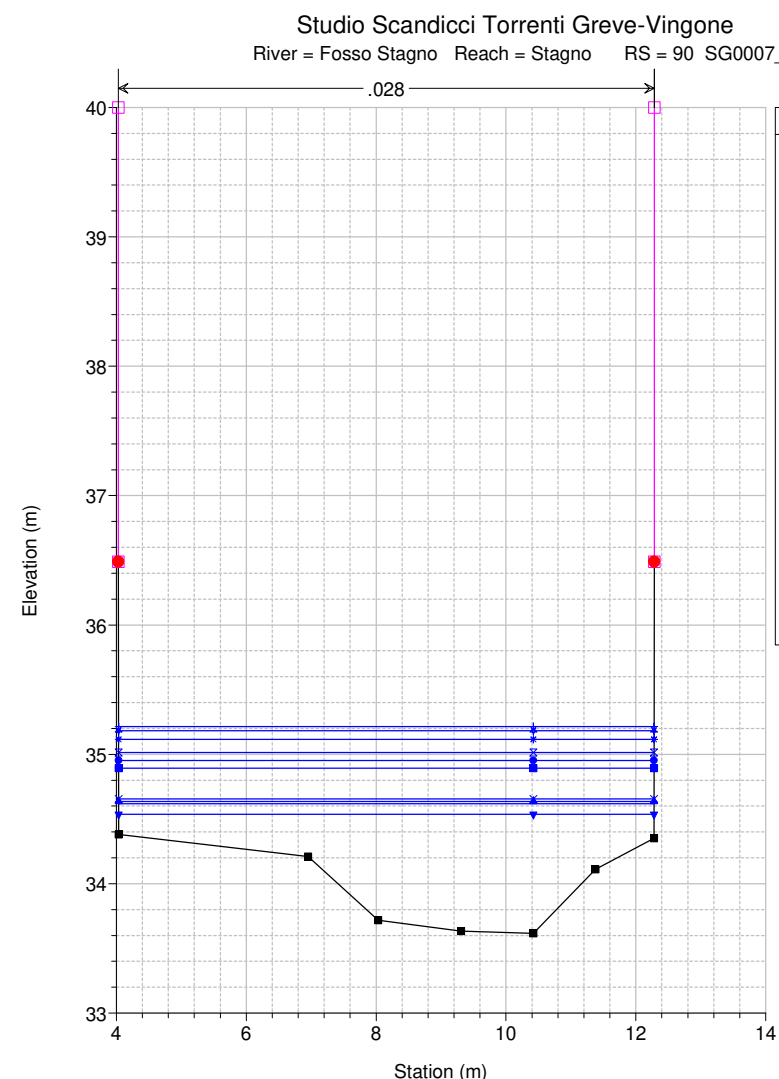
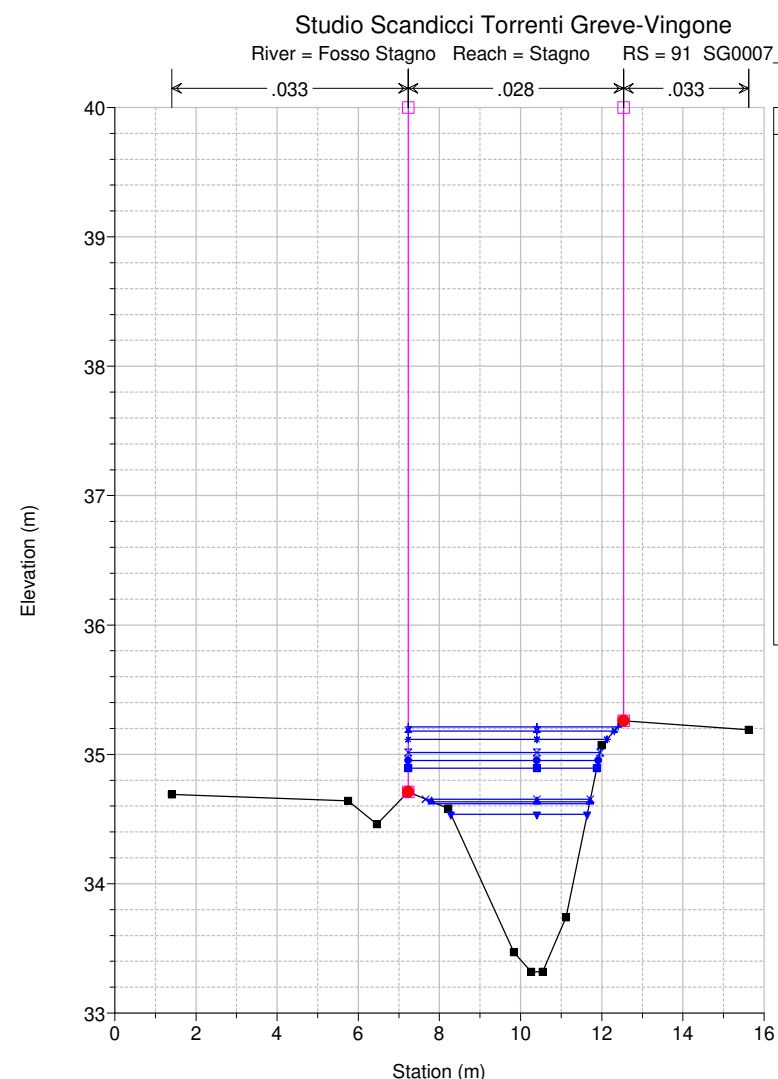

Studio Scandicci Torrenti Greve-Vingone
River = Fosso Stagno Reach = Stagno RS = 87 SG0008

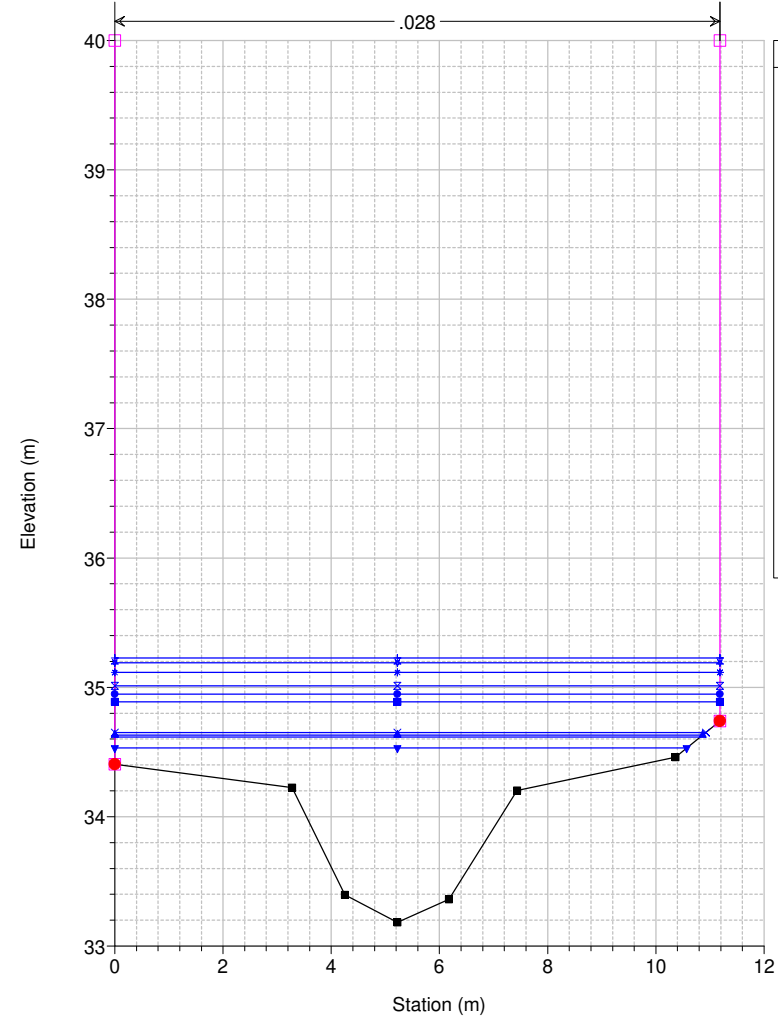

Legend

- WS Max WS - TR030_18_0
- WS Max WS - TR030_24_0
- WS Max WS - TR030_36_0
- WS Max WS - TR030_12_0
- WS Max WS - TR030_09_0
- WS Max WS - TR030_06_0
- WS Max WS - TR030_03_0
- WS Max WS - TR030_01_0
- WS Max WS - TR030_00_5
- WS Max WS - TR030_01_5
- Ground
- Levee
- Bank Sta

Studio Scandicci Torrenti Greve-Vingone
River = Fosso Stagno Reach = Stagno RS = 86 SG0009

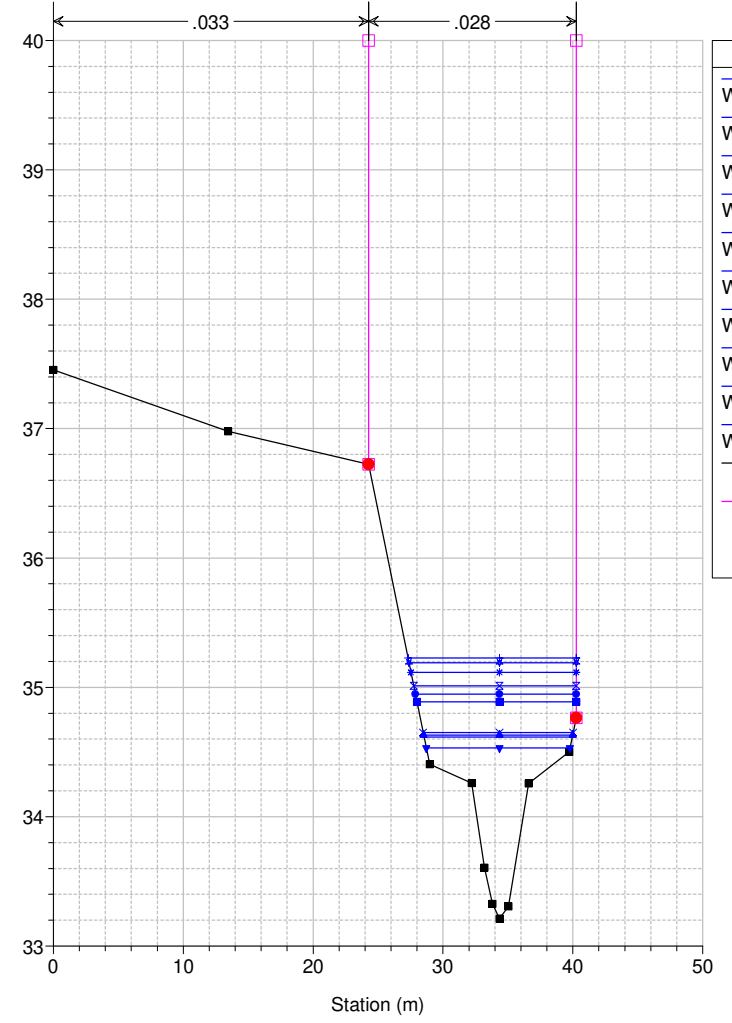

Legend

- WS Max WS - TR030_18_0
- WS Max WS - TR030_24_0
- WS Max WS - TR030_36_0
- WS Max WS - TR030_12_0
- WS Max WS - TR030_09_0
- WS Max WS - TR030_06_0
- WS Max WS - TR030_03_0
- WS Max WS - TR030_01_0
- WS Max WS - TR030_00_5
- WS Max WS - TR030_01_5
- Ground
- Levee
- Bank Sta

Studio Scandicci Torrenti Greve-Vingone
River = Fosso Stagno Reach = Stagno RS = 85 SG0010

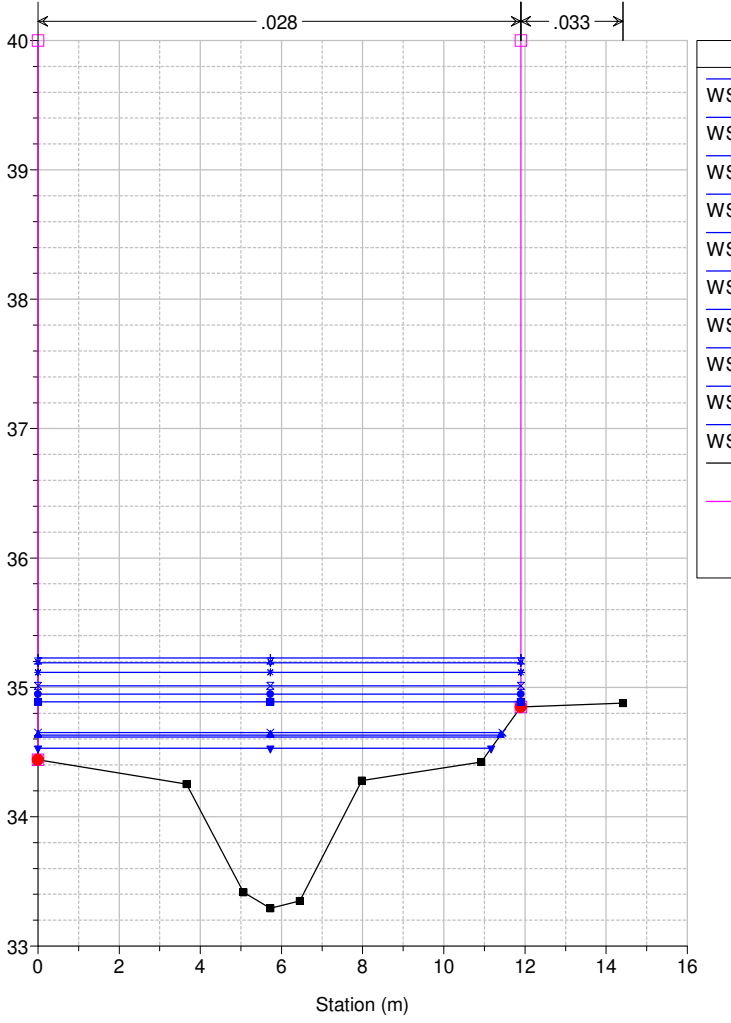

Legend

- WS Max WS - TR030_18_0
- WS Max WS - TR030_24_0
- WS Max WS - TR030_36_0
- WS Max WS - TR030_12_0
- WS Max WS - TR030_09_0
- WS Max WS - TR030_06_0
- WS Max WS - TR030_03_0
- WS Max WS - TR030_01_0
- WS Max WS - TR030_00_5
- WS Max WS - TR030_01_5
- Ground
- Levee
- Bank Sta

Studio Scandicci Torrenti Greve-Vingone
River = Fosso Stagno Reach = Stagno RS = 84 SG0011

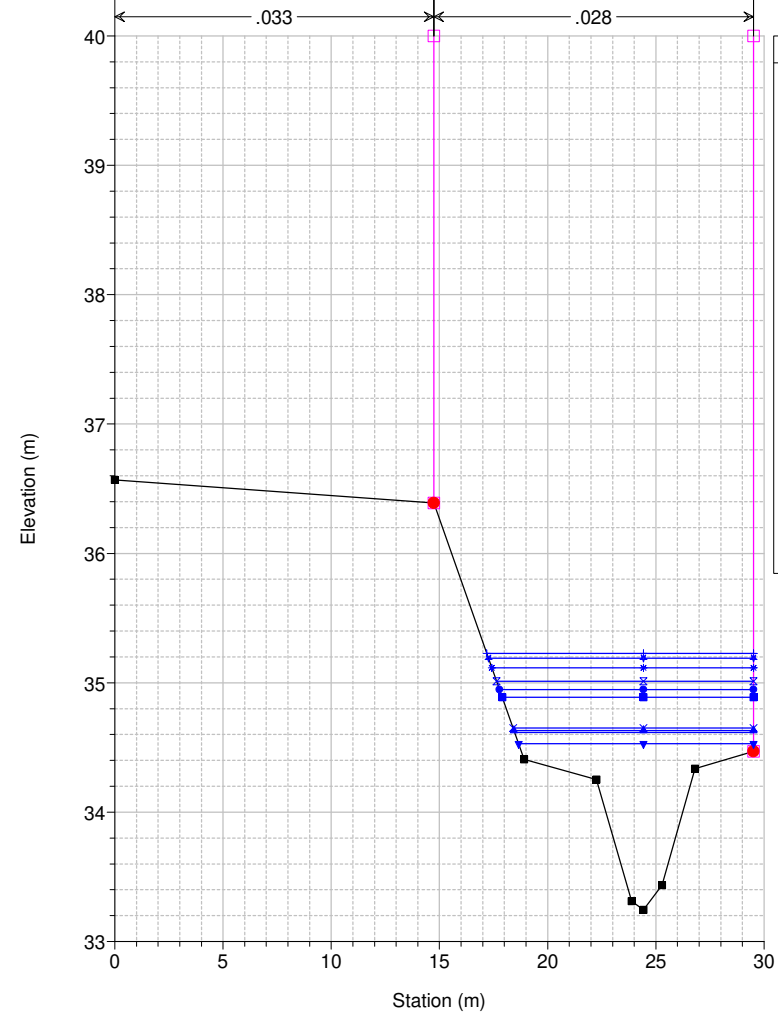

Legend

- WS Max WS - TR030_18_0
- WS Max WS - TR030_24_0
- WS Max WS - TR030_36_0
- WS Max WS - TR030_12_0
- WS Max WS - TR030_09_0
- WS Max WS - TR030_06_0
- WS Max WS - TR030_03_0
- WS Max WS - TR030_01_0
- WS Max WS - TR030_00_5
- WS Max WS - TR030_01_5
- Ground
- Levee
- Bank Sta

Studio Scandicci Torrenti Greve-Vingone
River = Fosso Stagno Reach = Stagno RS = 83 SG0012_A

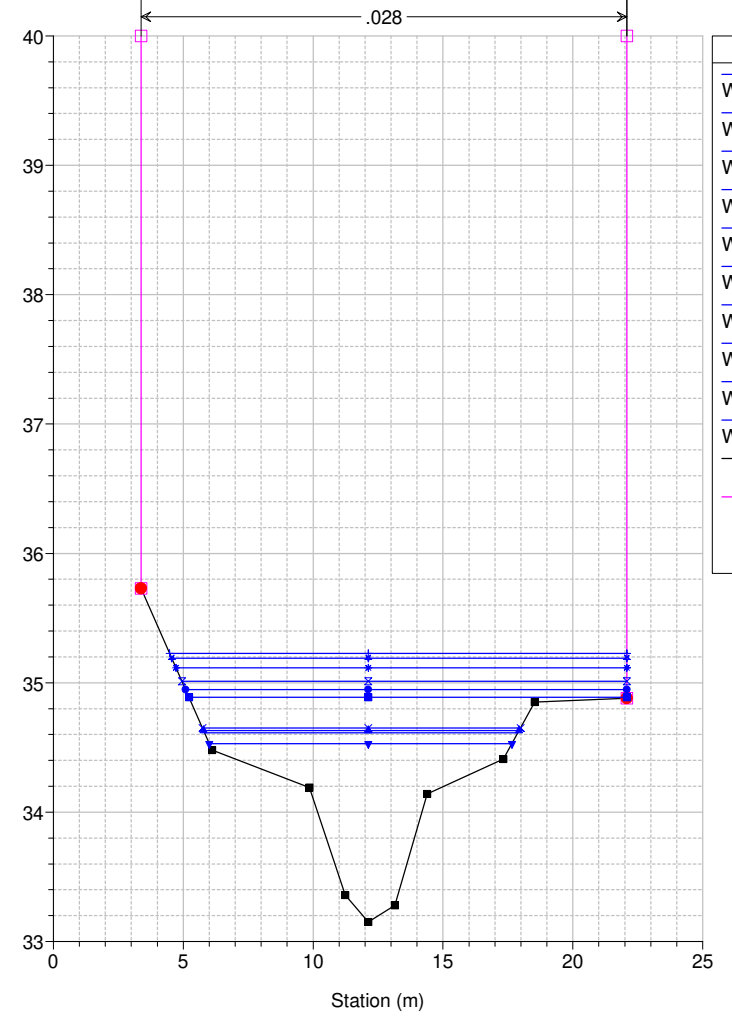

Legend

- WS Max WS - TR030_18_0
- WS Max WS - TR030_24_0
- WS Max WS - TR030_36_0
- WS Max WS - TR030_12_0
- WS Max WS - TR030_09_0
- WS Max WS - TR030_06_0
- WS Max WS - TR030_03_0
- WS Max WS - TR030_01_0
- WS Max WS - TR030_00_5
- WS Max WS - TR030_01_5
- Ground
- Levee
- Bank Sta

Studio Scandicci Torrenti Greve-Vingone
River = Fosso Stagno Reach = Stagno RS = 82 SG0012_B

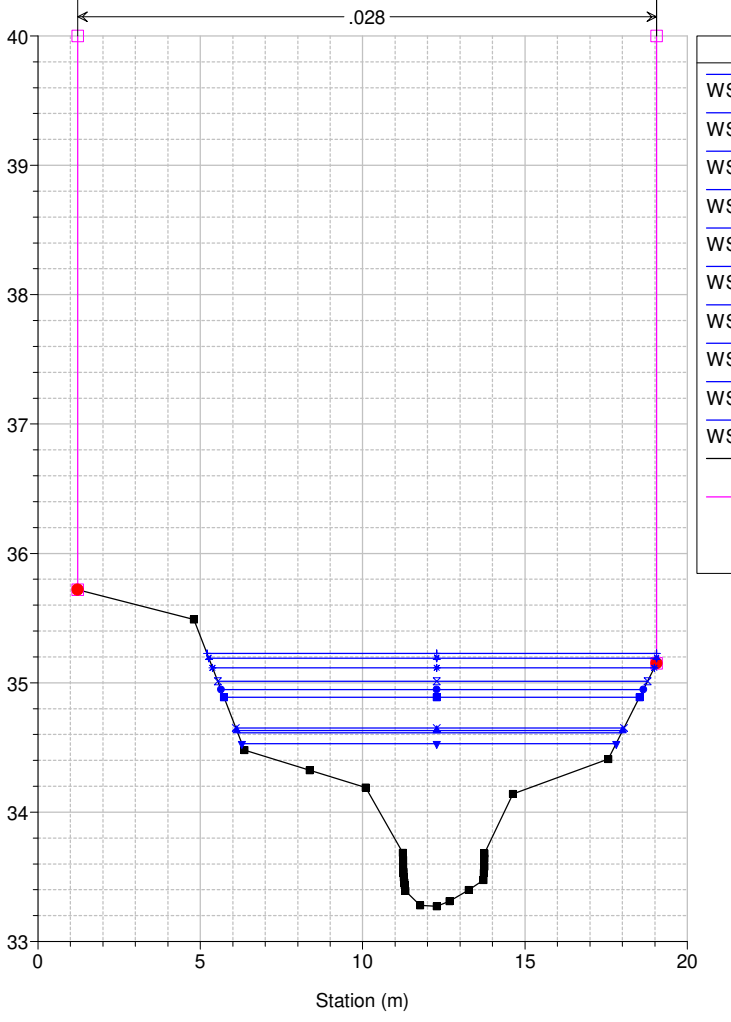

Legend

- WS Max WS - TR030_18_0
- WS Max WS - TR030_24_0
- WS Max WS - TR030_36_0
- WS Max WS - TR030_12_0
- WS Max WS - TR030_09_0
- WS Max WS - TR030_06_0
- WS Max WS - TR030_03_0
- WS Max WS - TR030_01_0
- WS Max WS - TR030_00_5
- WS Max WS - TR030_01_5
- Ground
- Levee
- Bank Sta

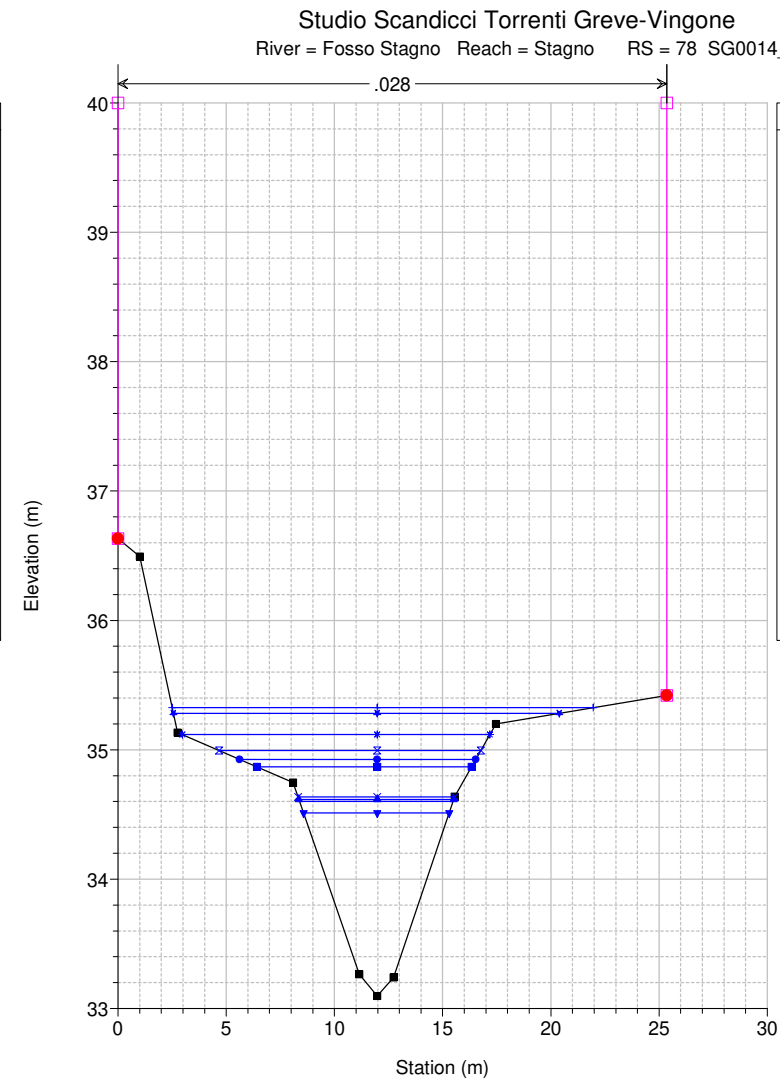
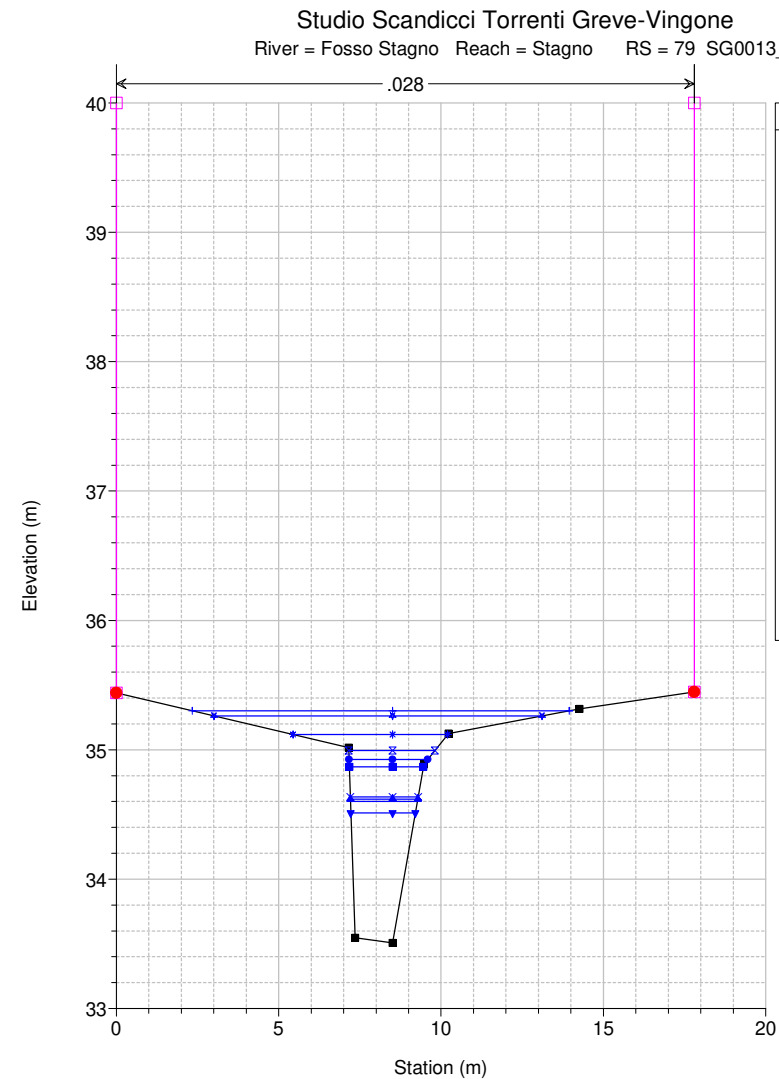
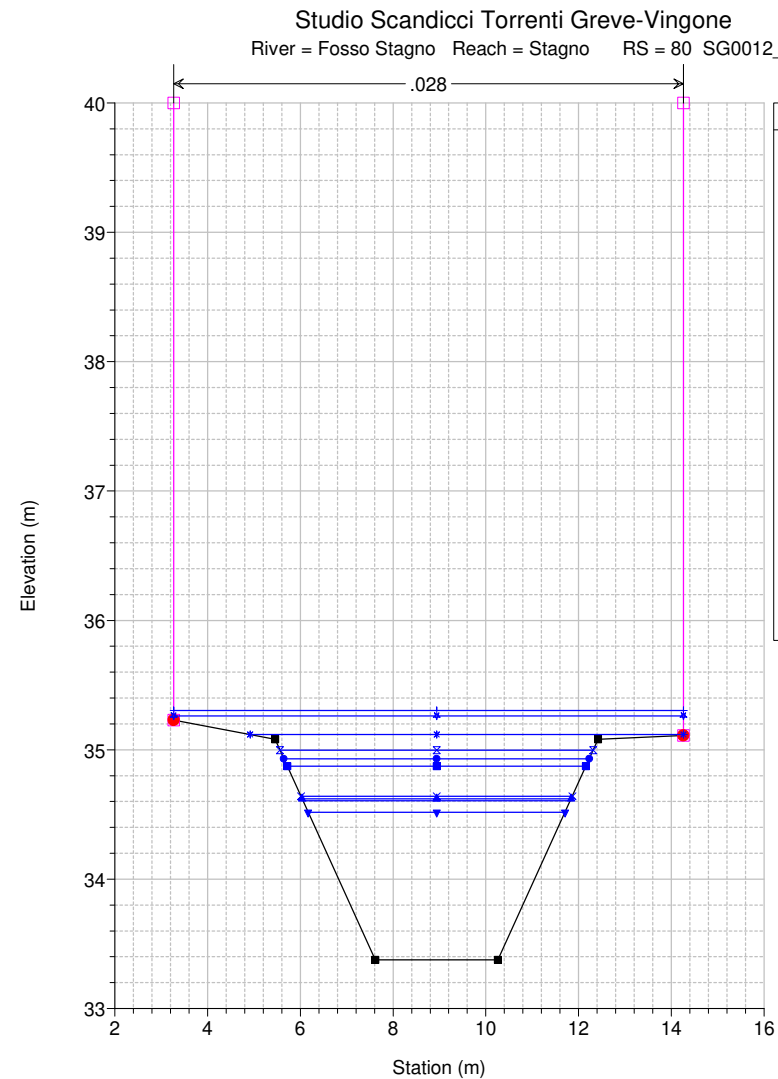
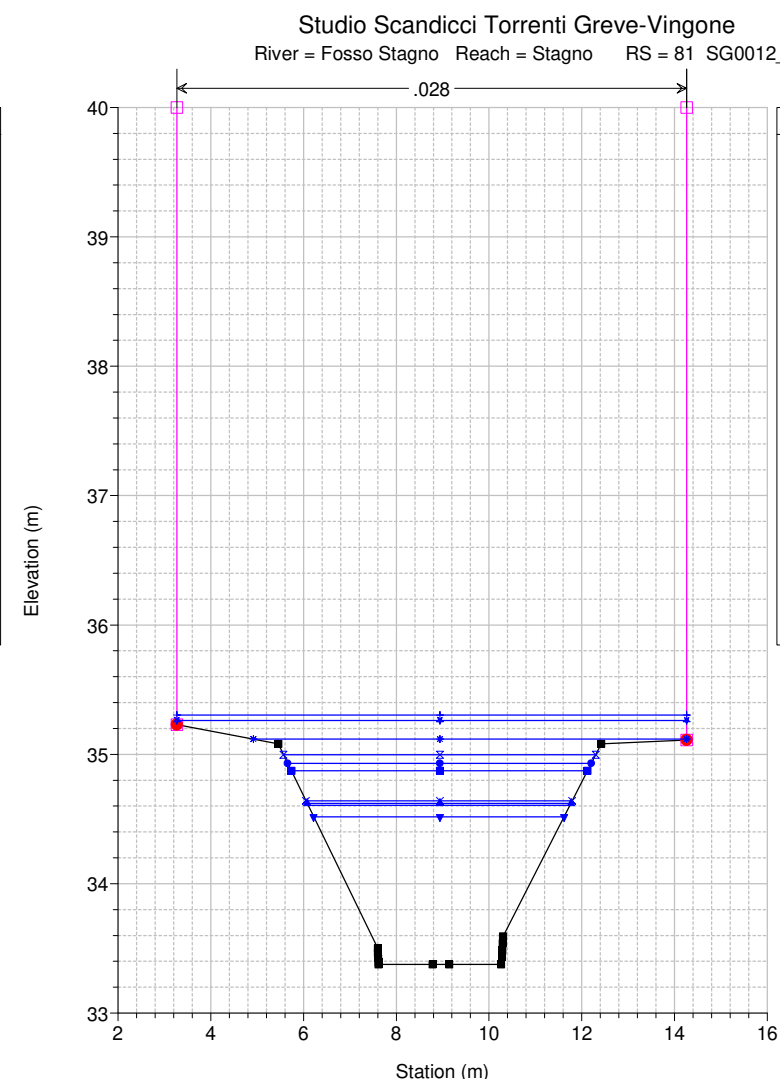
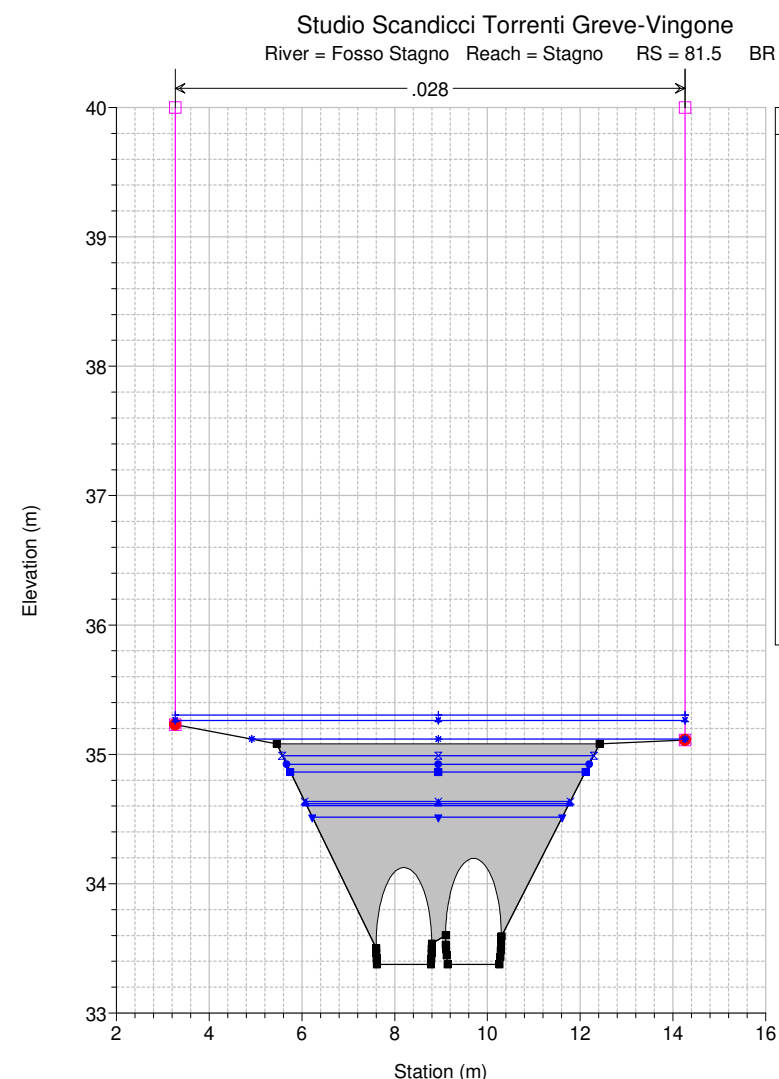
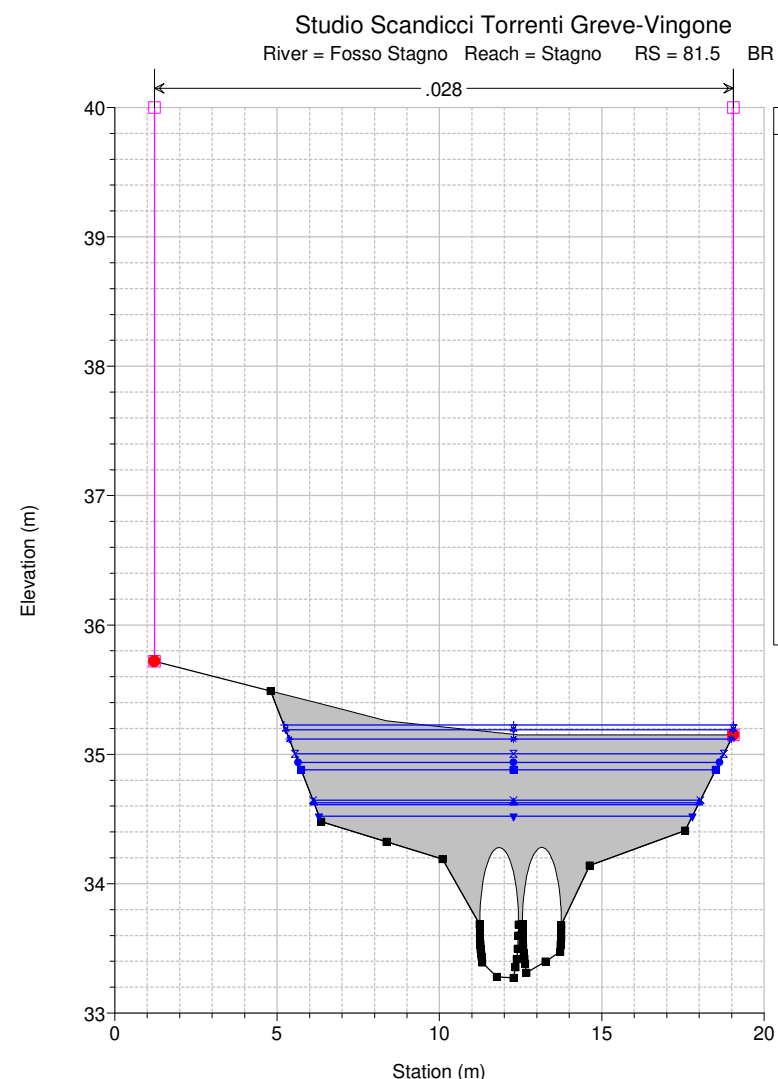

Studio Scandicci Torrenti Greve-Vingone
River = Fosso Stagno Reach = Stagno RS = 77 SG0015_

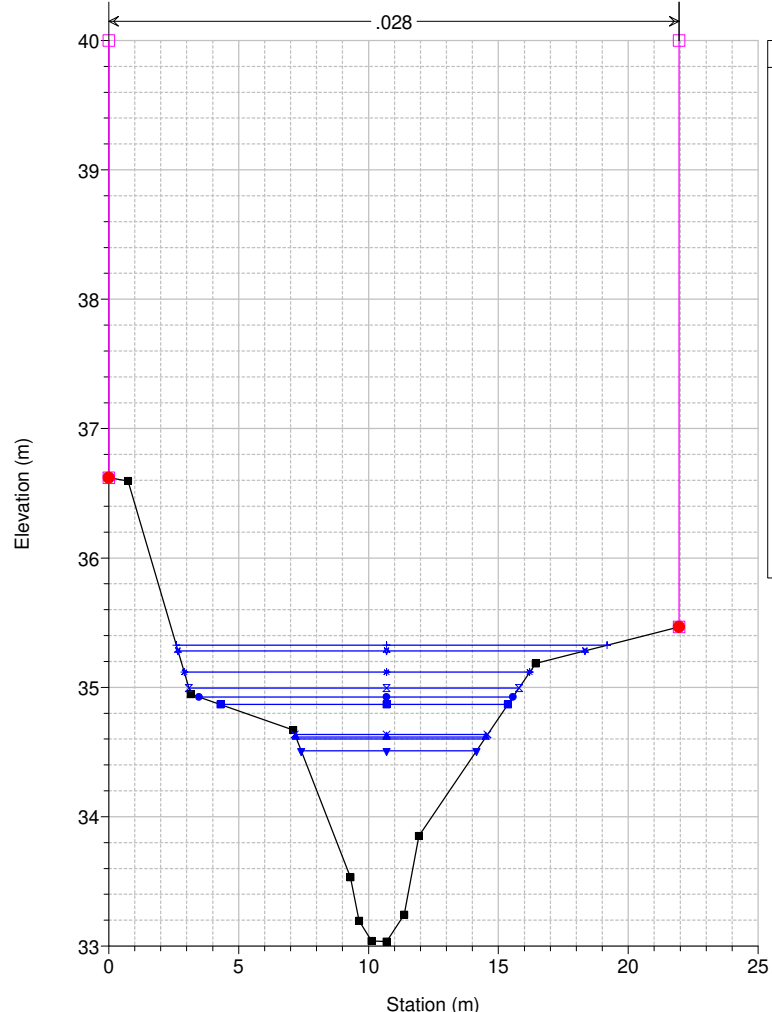

Legend	
WS Max WS - TR030_18_0	+
WS Max WS - TR030_24_0	*
WS Max WS - TR030_36_0	•
WS Max WS - TR030_12_0	x
WS Max WS - TR030_09_0	•
WS Max WS - TR030_06_0	■
WS Max WS - TR030_03_0	x
WS Max WS - TR030_01_0	▲
WS Max WS - TR030_00_5	▼
WS Max WS - TR030_01_5	•
Ground	■
Levee	□
Bank Sta	•

Studio Scandicci Torrenti Greve-Vingone
River = Fosso Stagno Reach = Stagno RS = 76 SG0016_

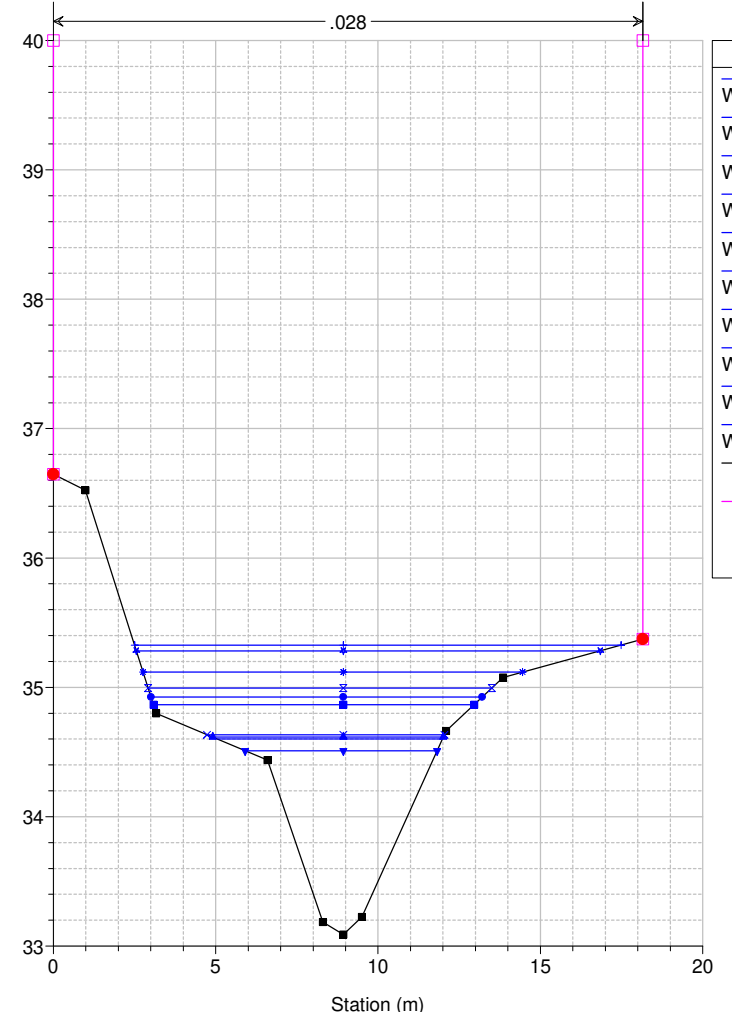

Legend	
WS Max WS - TR030_18_0	+
WS Max WS - TR030_24_0	*
WS Max WS - TR030_36_0	•
WS Max WS - TR030_12_0	x
WS Max WS - TR030_09_0	•
WS Max WS - TR030_06_0	■
WS Max WS - TR030_03_0	x
WS Max WS - TR030_01_0	▲
WS Max WS - TR030_00_5	▼
WS Max WS - TR030_01_5	•
Ground	■
Levee	□
Bank Sta	•

Studio Scandicci Torrenti Greve-Vingone
River = Fosso Stagno Reach = Stagno RS = 75 SG0017_A

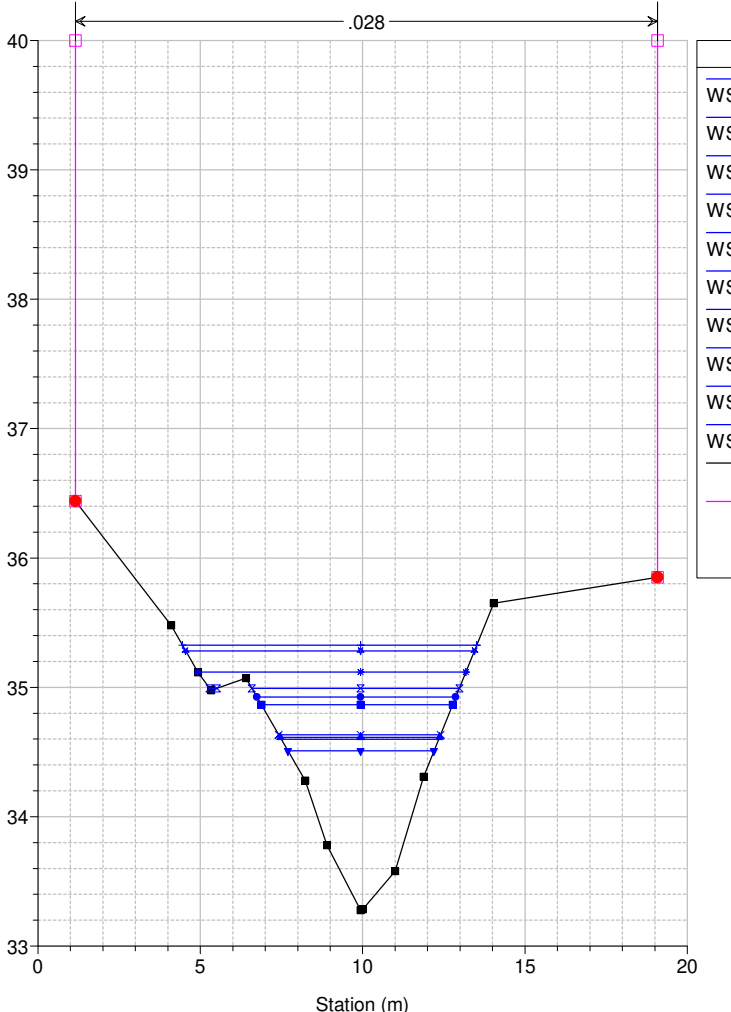

Legend	
WS Max WS - TR030_18_0	+
WS Max WS - TR030_24_0	*
WS Max WS - TR030_36_0	•
WS Max WS - TR030_12_0	x
WS Max WS - TR030_09_0	•
WS Max WS - TR030_06_0	■
WS Max WS - TR030_03_0	x
WS Max WS - TR030_01_0	▲
WS Max WS - TR030_00_5	▼
WS Max WS - TR030_01_5	•
Ground	■
Levee	□
Bank Sta	•

Studio Scandicci Torrenti Greve-Vingone
River = Fosso Stagno Reach = Stagno RS = 74 SG0017_B

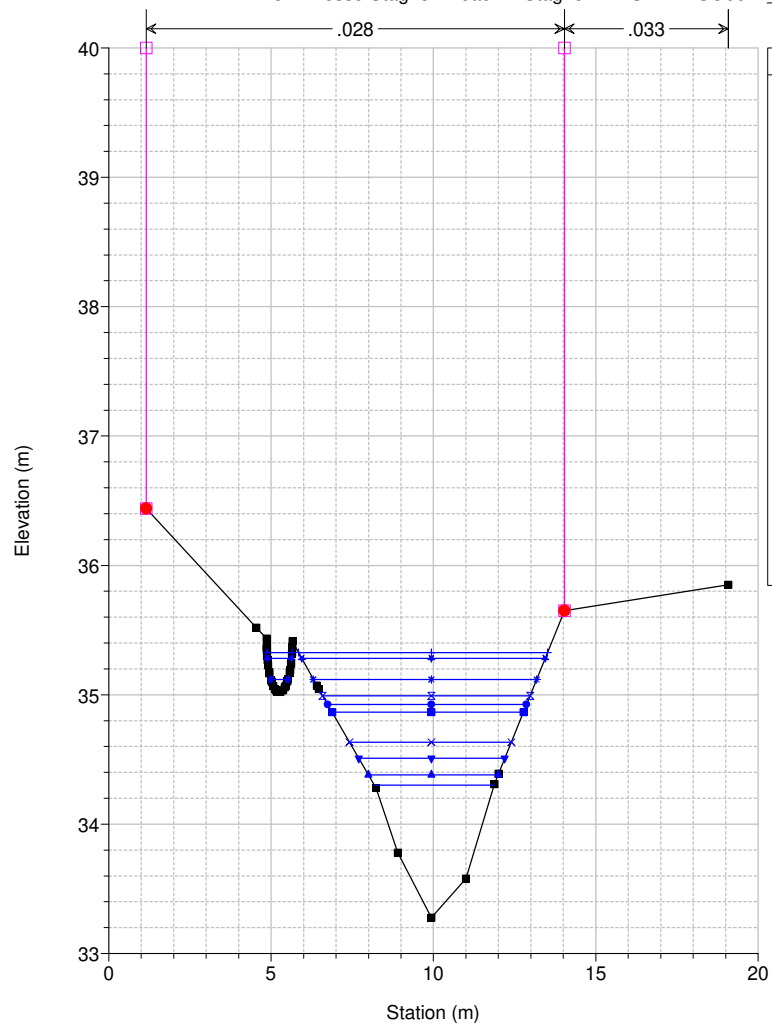

Legend	
WS Max WS - TR030_18_0	+
WS Max WS - TR030_24_0	*
WS Max WS - TR030_36_0	•
WS Max WS - TR030_12_0	x
WS Max WS - TR030_09_0	•
WS Max WS - TR030_06_0	■
WS Max WS - TR030_03_0	x
WS Max WS - TR030_01_5	▼
WS Max WS - TR030_01_0	▲
WS Max WS - TR030_00_5	▼
Ground	■
Levee	□
Bank Sta	•

Studio Scandicci Torrenti Greve-Vingone
River = Fosso Stagno Reach = Stagno RS = 73.5 BR

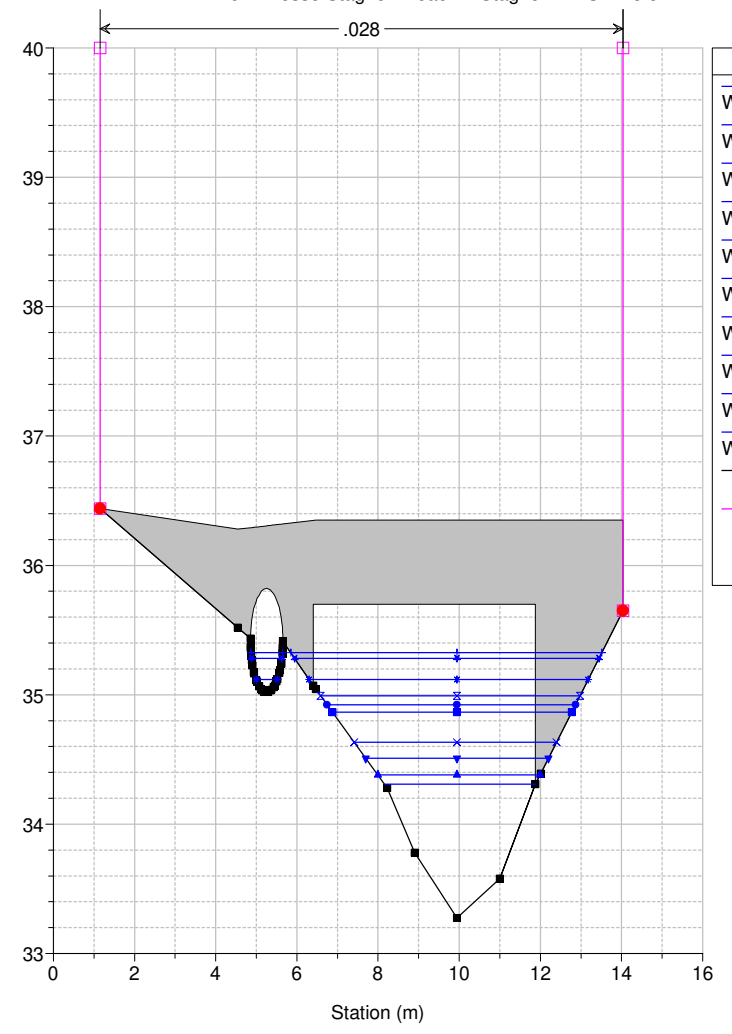

Legend	
WS Max WS - TR030_18_0	+
WS Max WS - TR030_24_0	*
WS Max WS - TR030_36_0	•
WS Max WS - TR030_12_0	x
WS Max WS - TR030_09_0	•
WS Max WS - TR030_06_0	■
WS Max WS - TR030_03_0	x
WS Max WS - TR030_01_5	▼
WS Max WS - TR030_01_0	▲
WS Max WS - TR030_00_5	▼
Ground	■
Levee	□
Bank Sta	•

Studio Scandicci Torrenti Greve-Vingone
River = Fosso Stagno Reach = Stagno RS = 73.5 BR

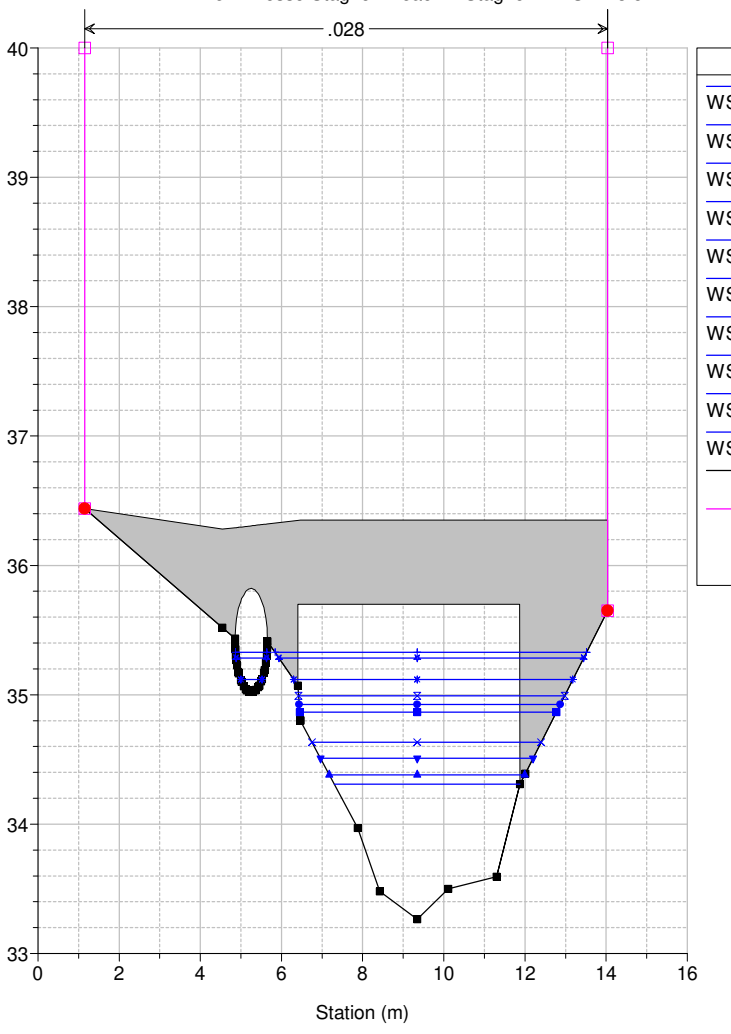

Legend	
WS Max WS - TR030_18_0	+
WS Max WS - TR030_24_0	*
WS Max WS - TR030_36_0	•
WS Max WS - TR030_12_0	x
WS Max WS - TR030_09_0	•
WS Max WS - TR030_06_0	■
WS Max WS - TR030_03_0	x
WS Max WS - TR030_01_5	▼
WS Max WS - TR030_01_0	▲
WS Max WS - TR030_00_5	▼
Ground	■
Levee	□
Bank Sta	•

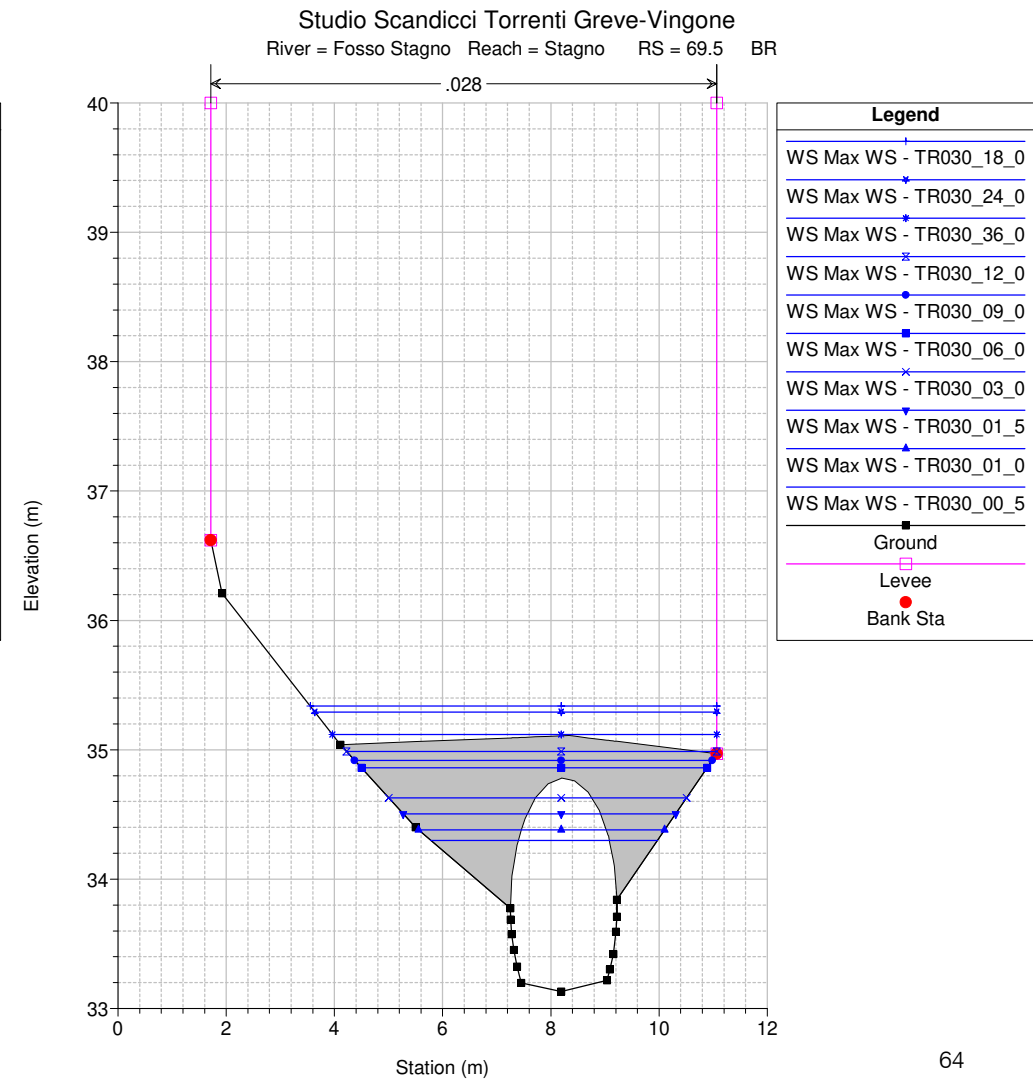
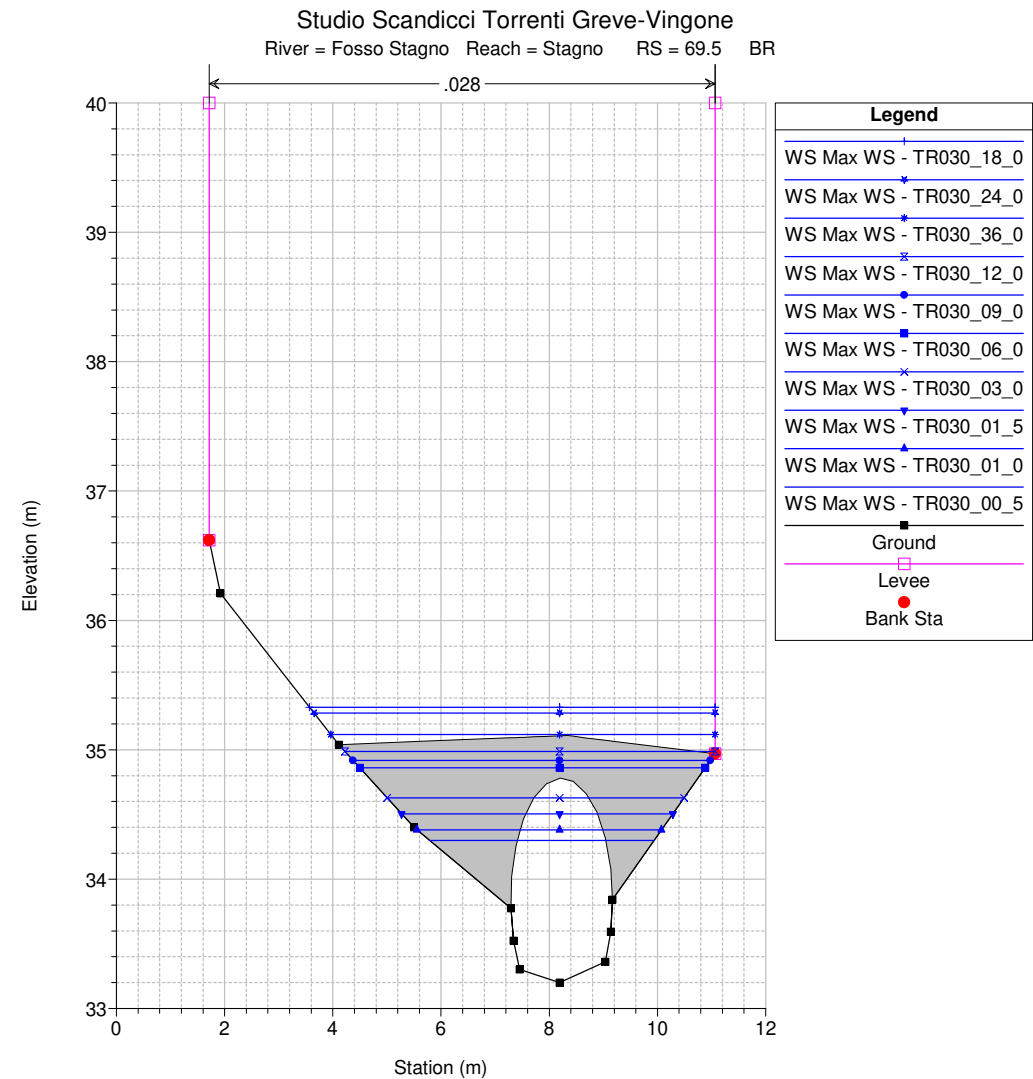
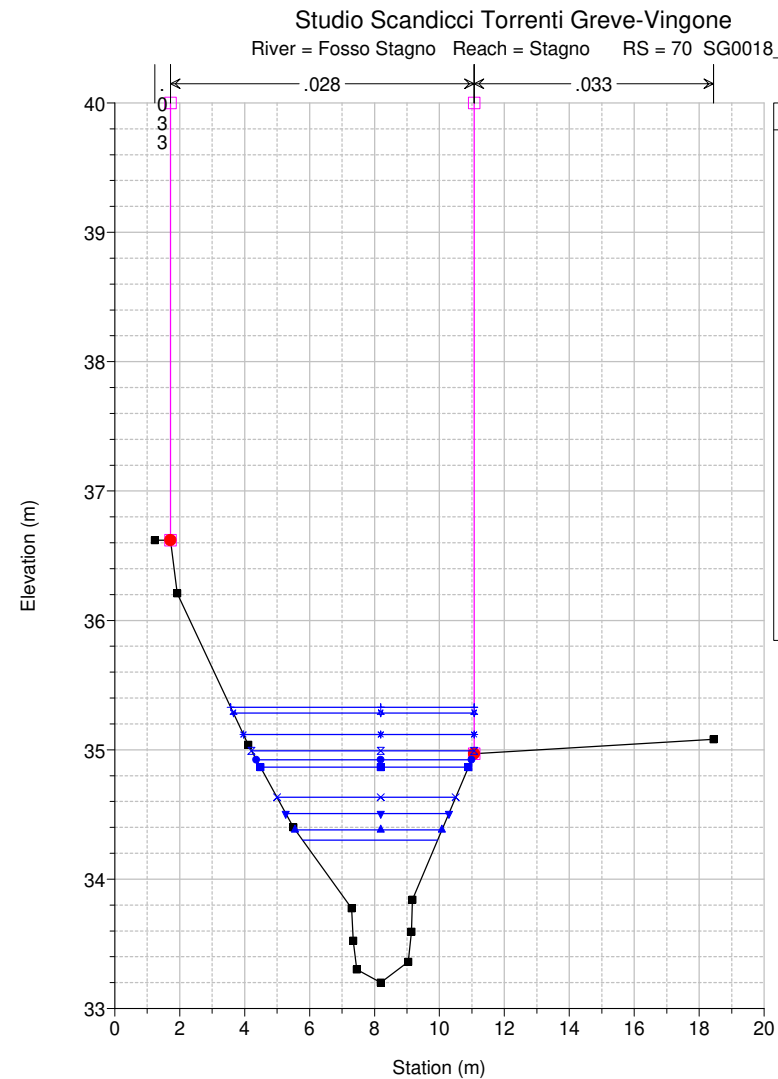
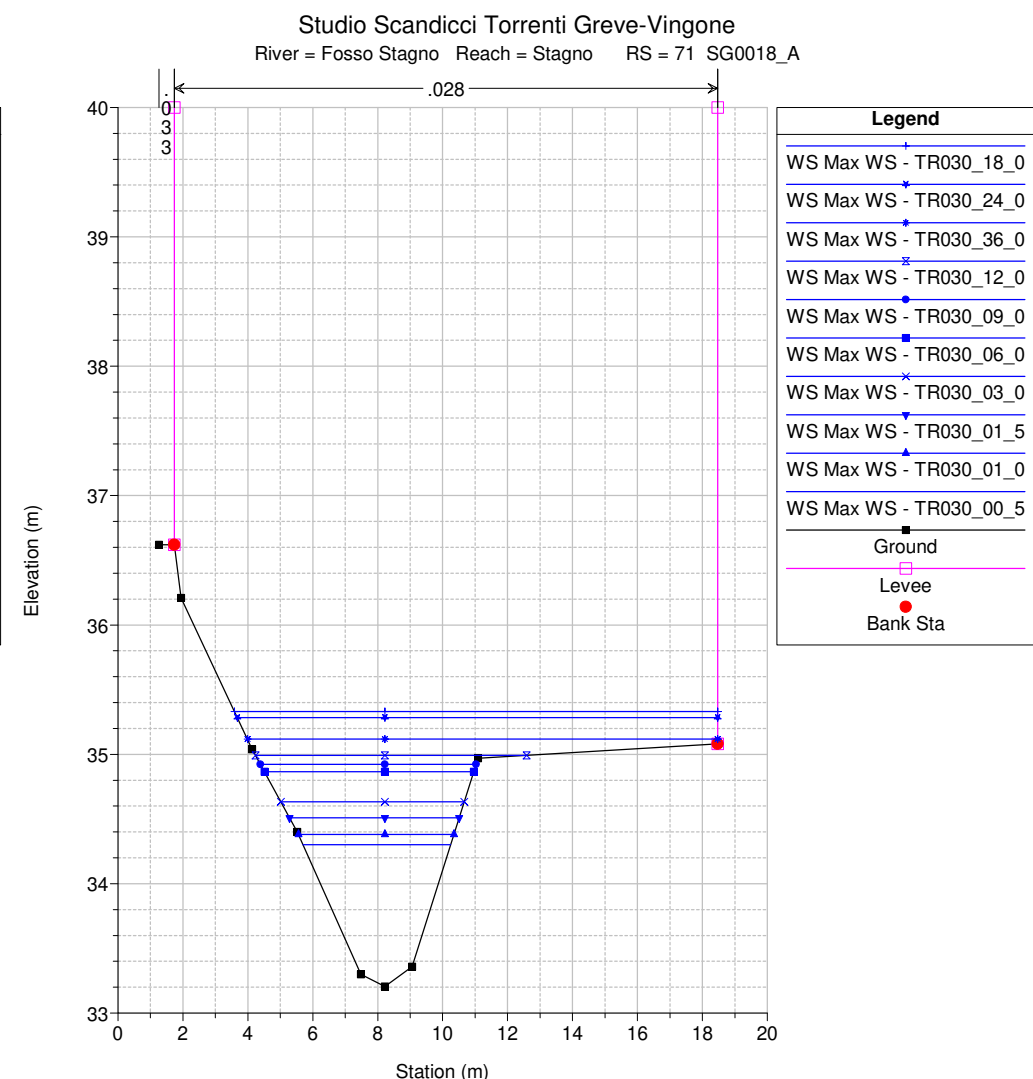
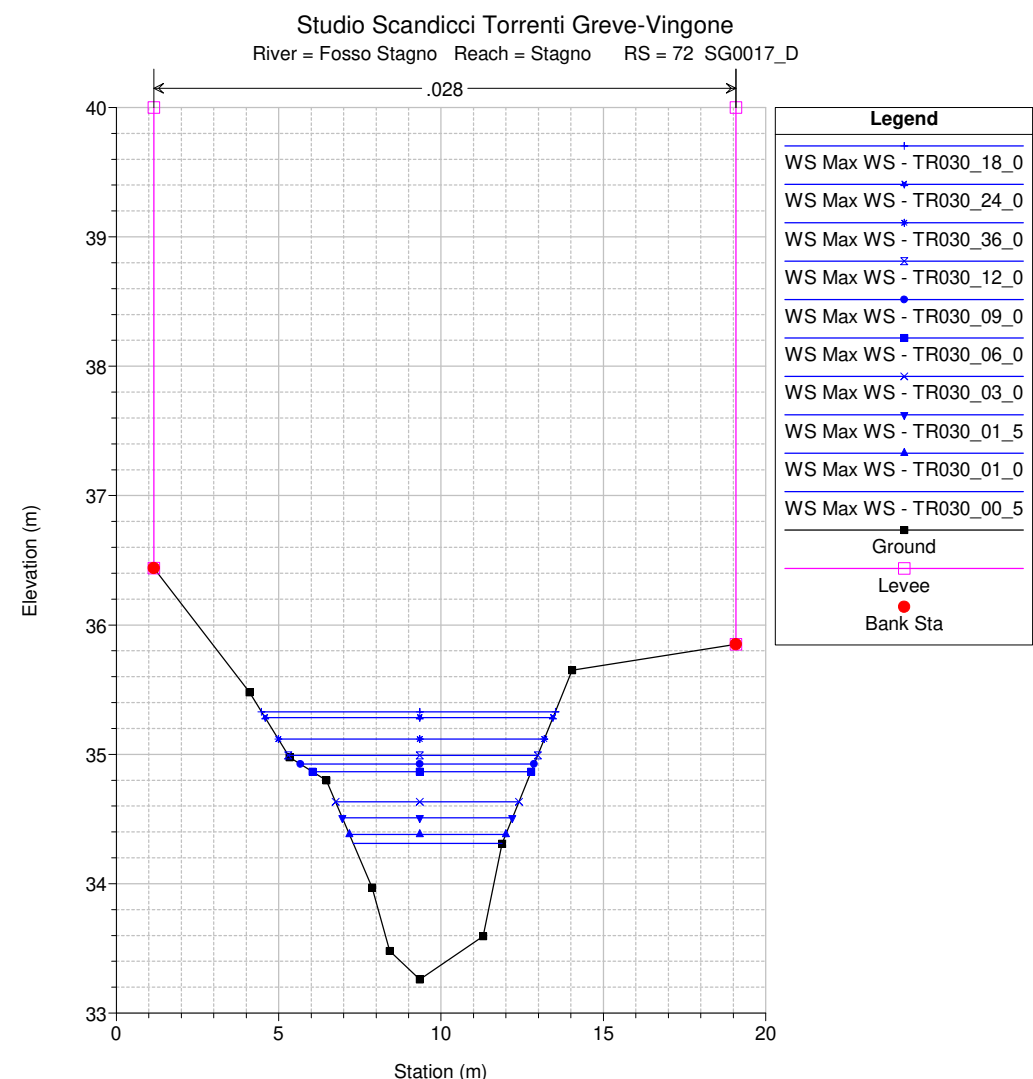
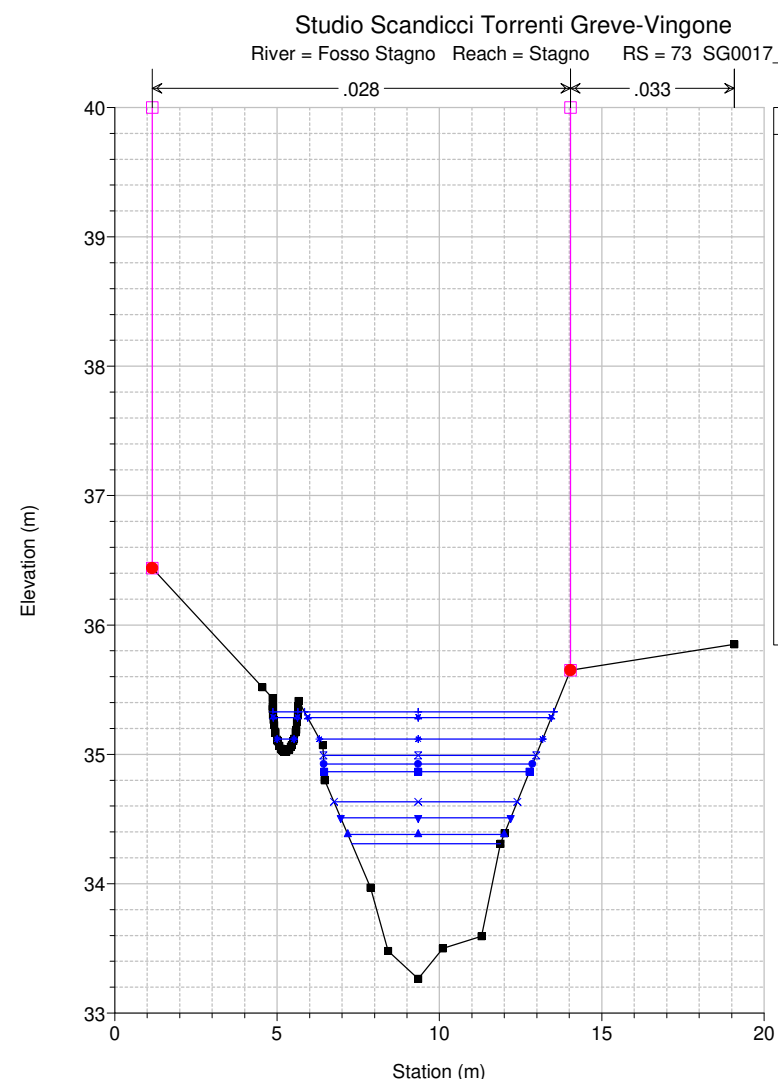

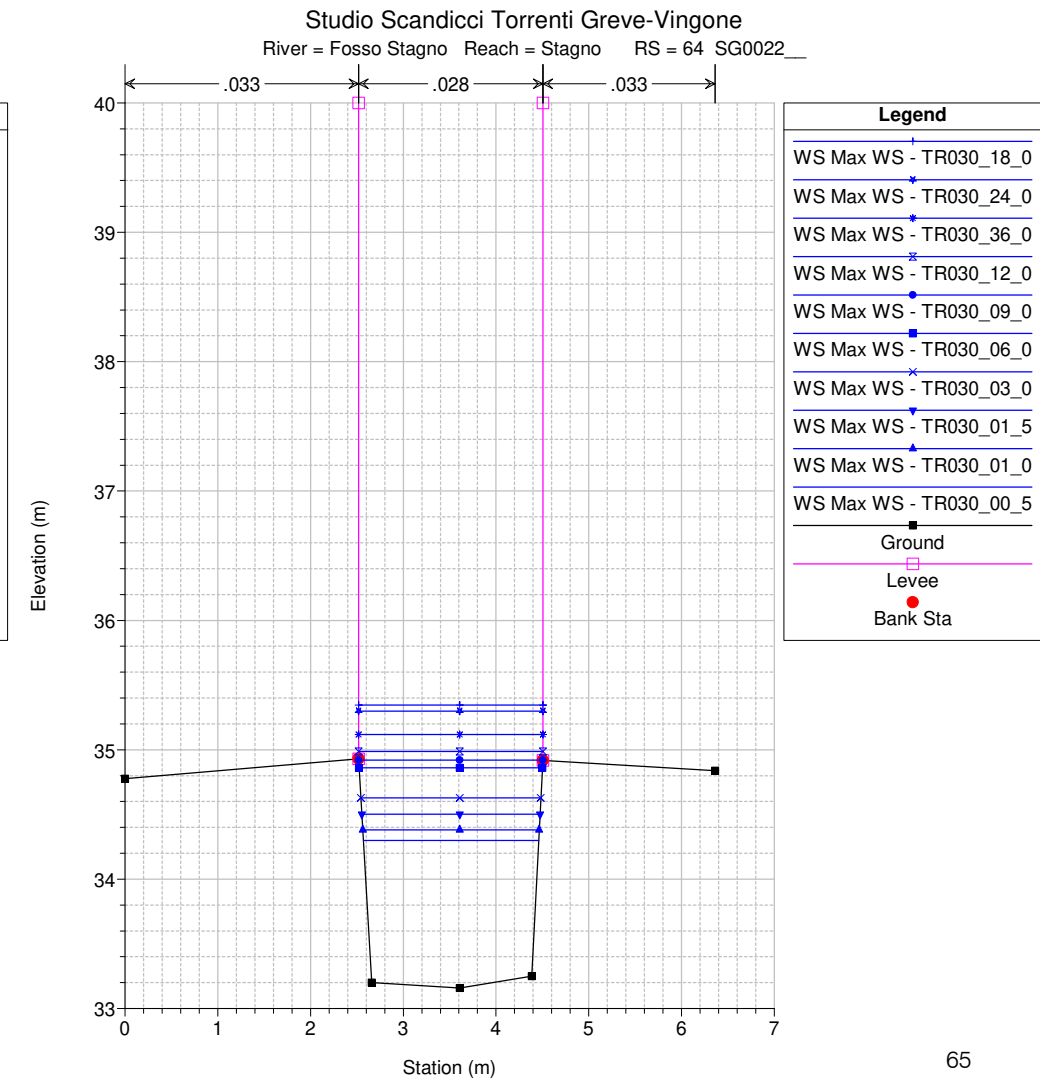
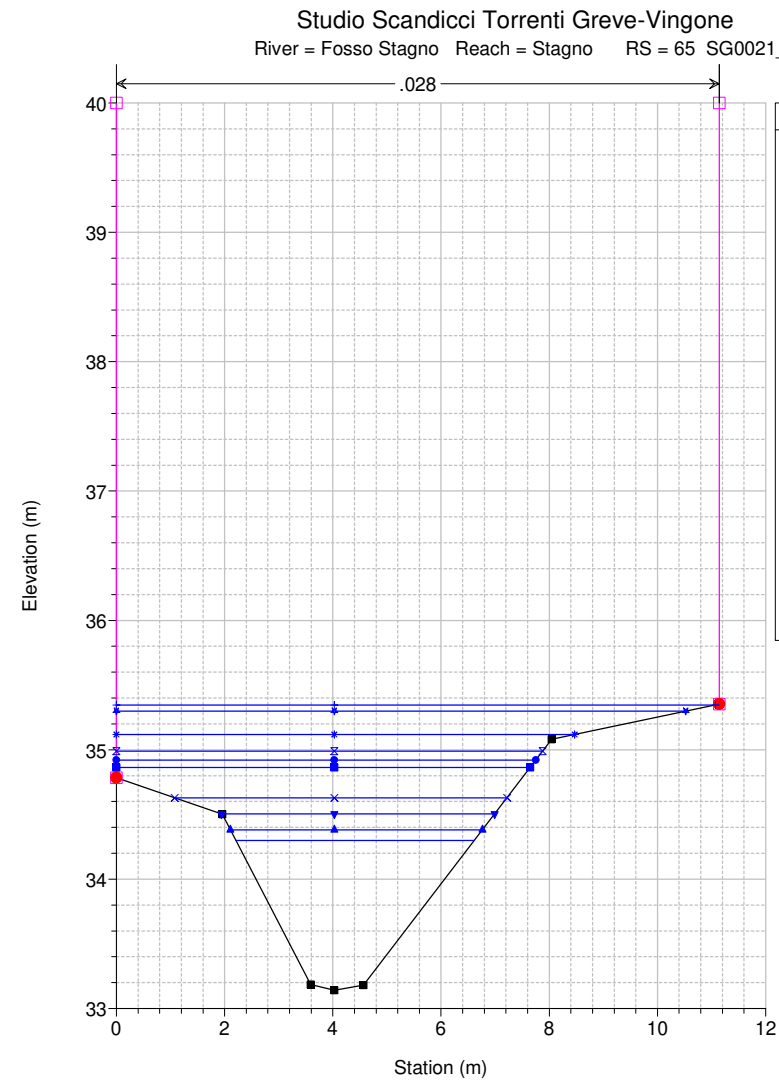
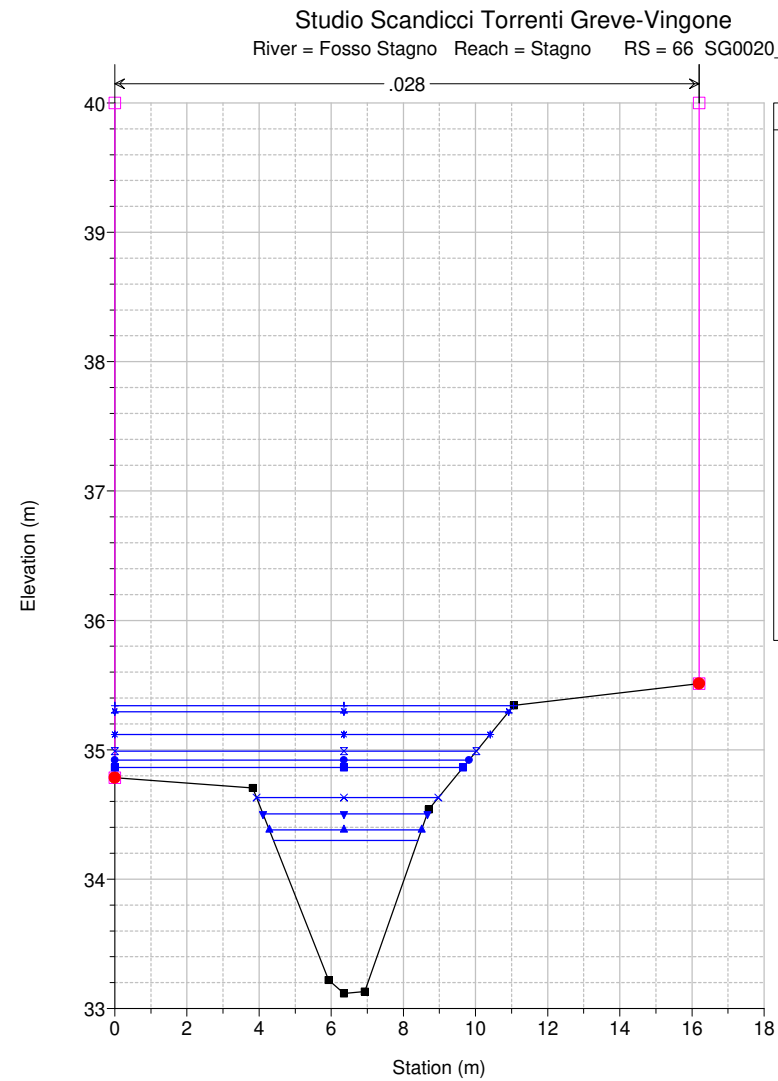
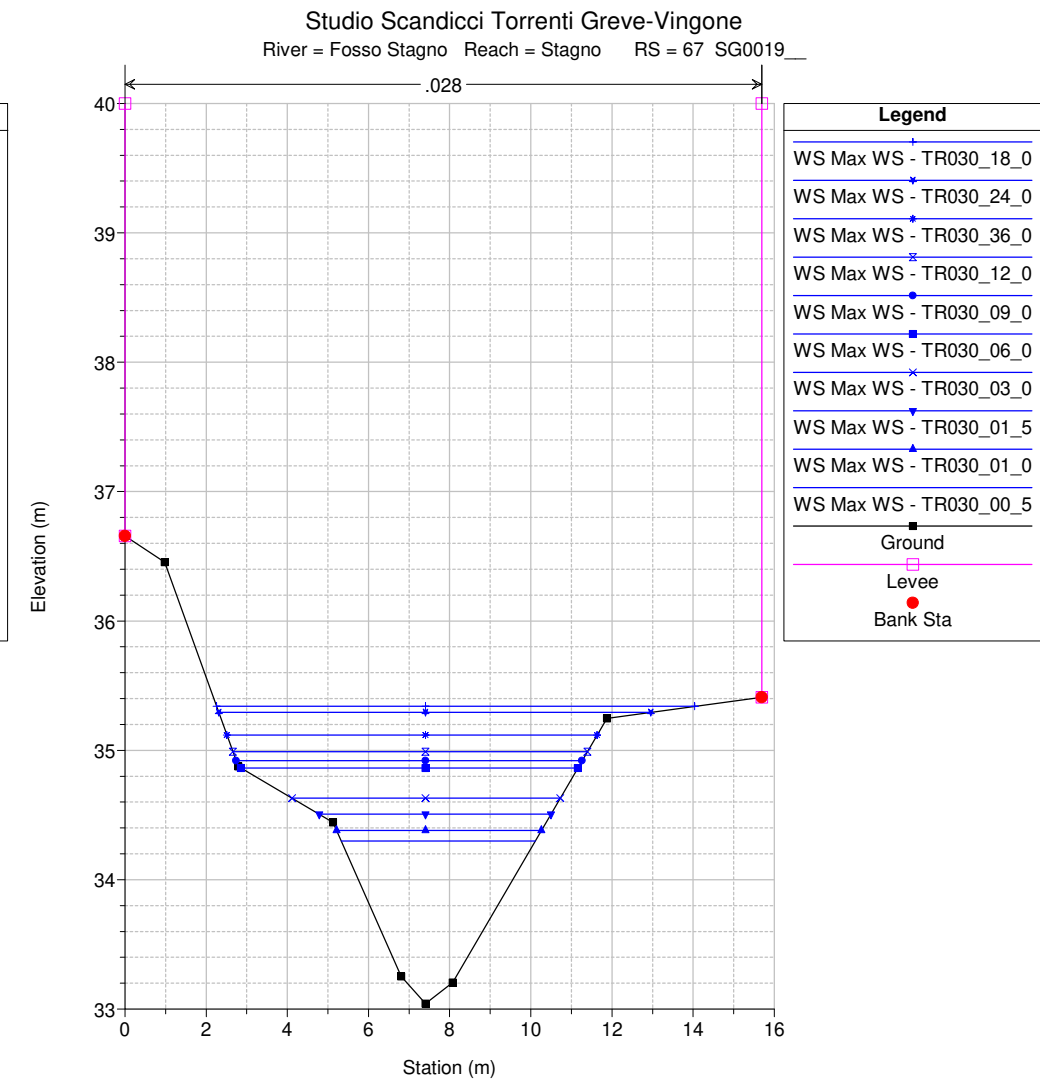
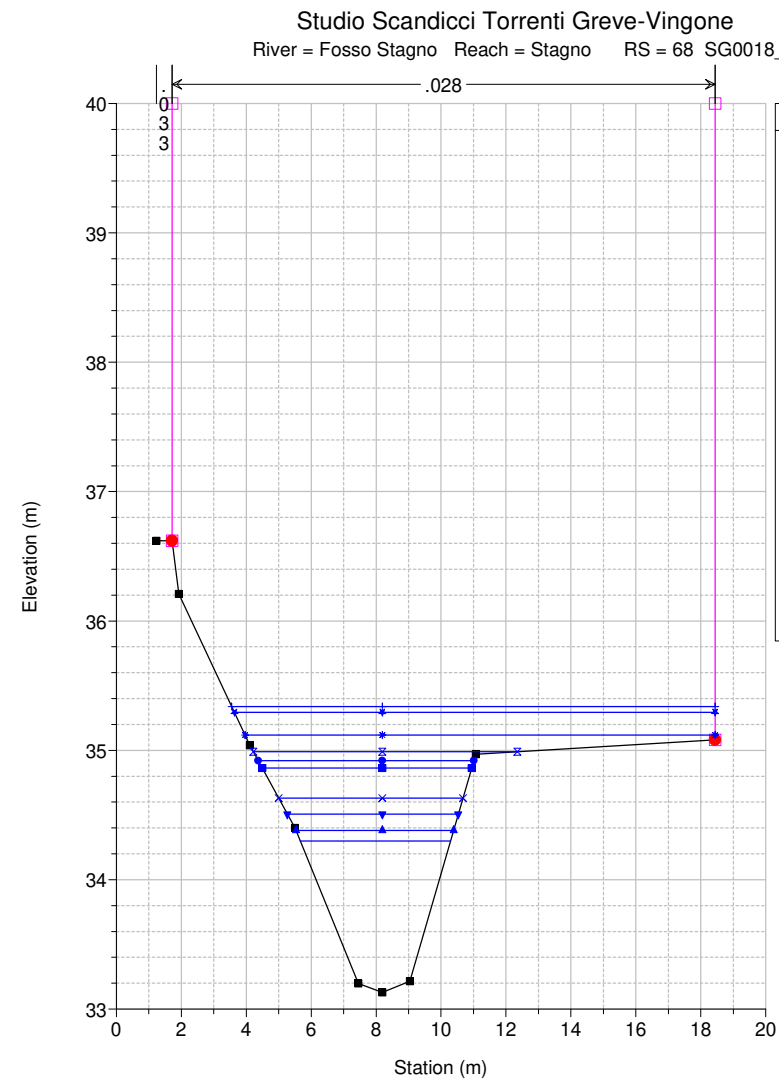
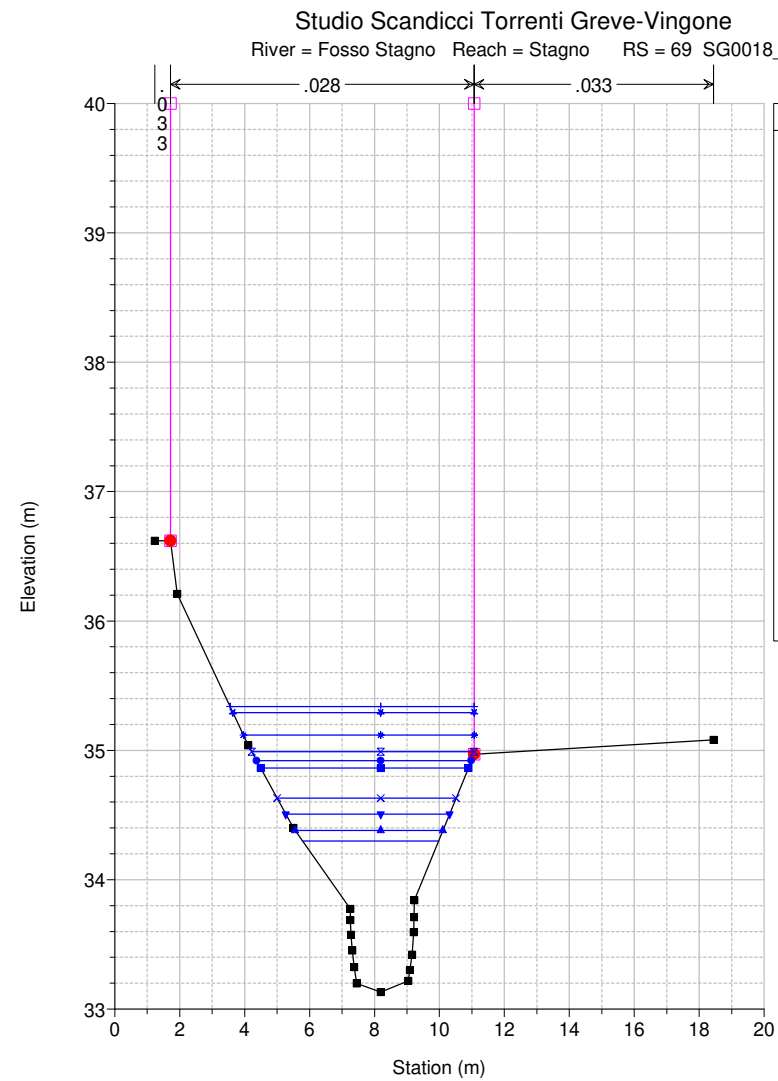

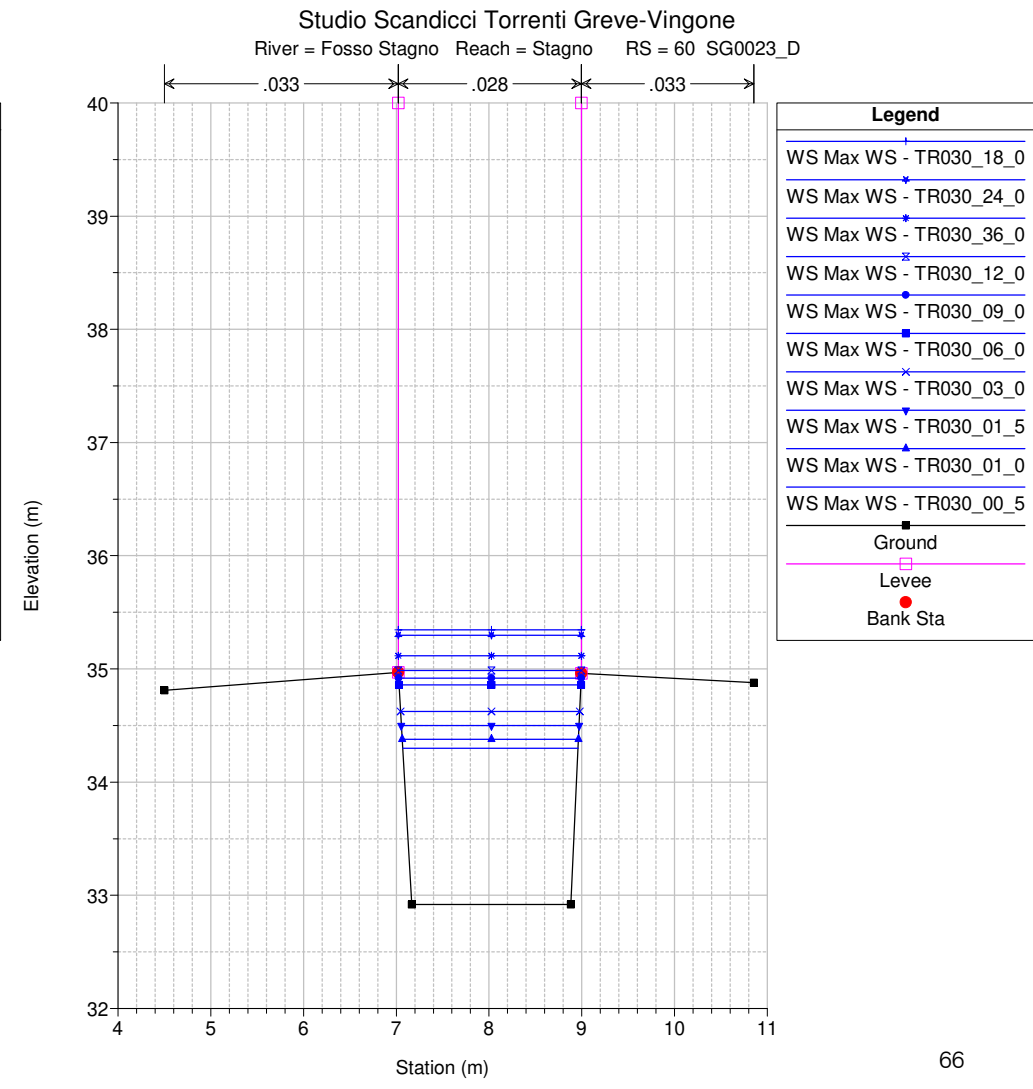
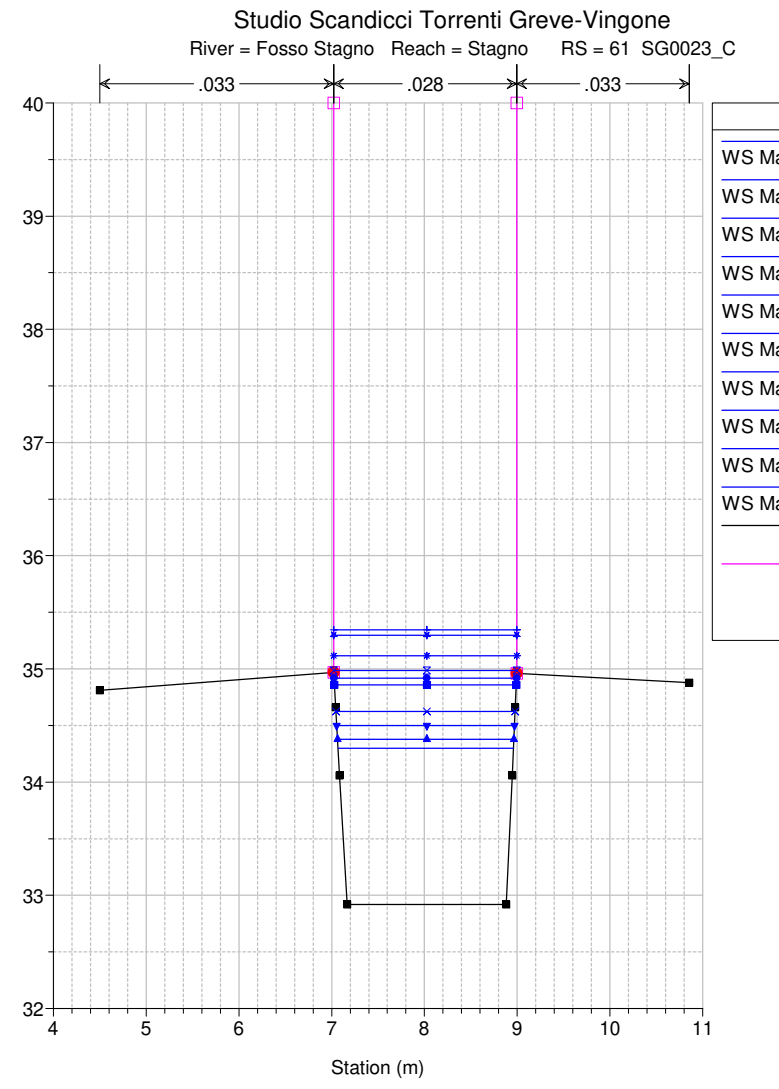
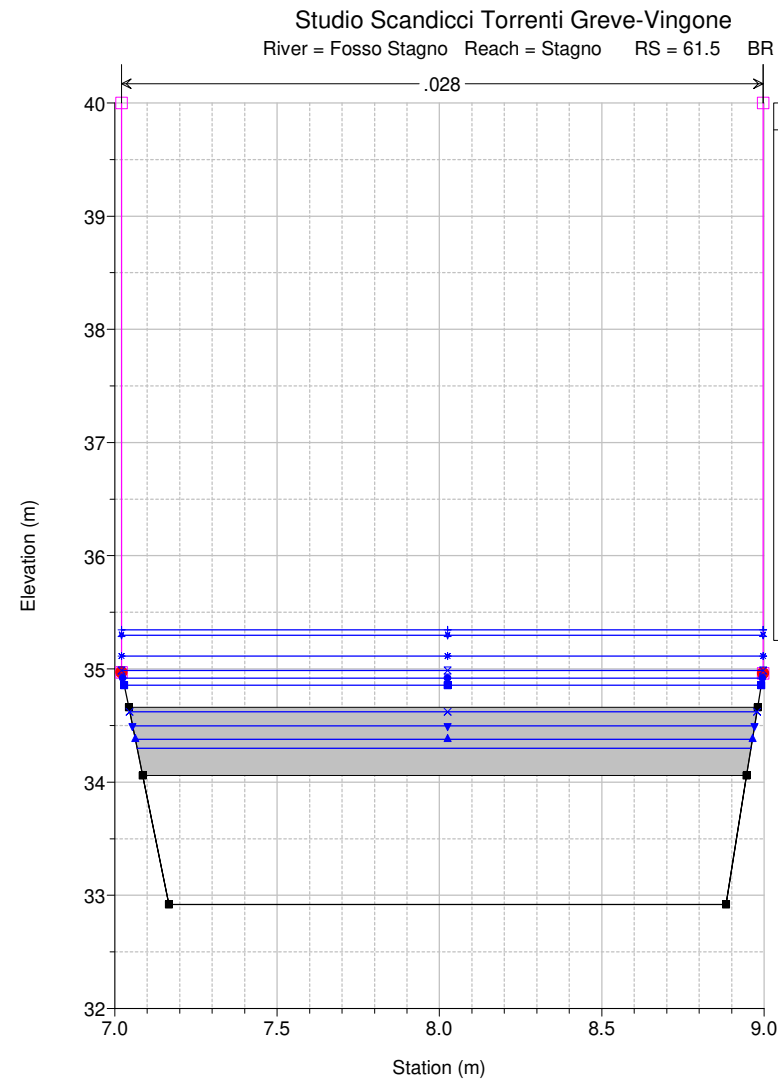
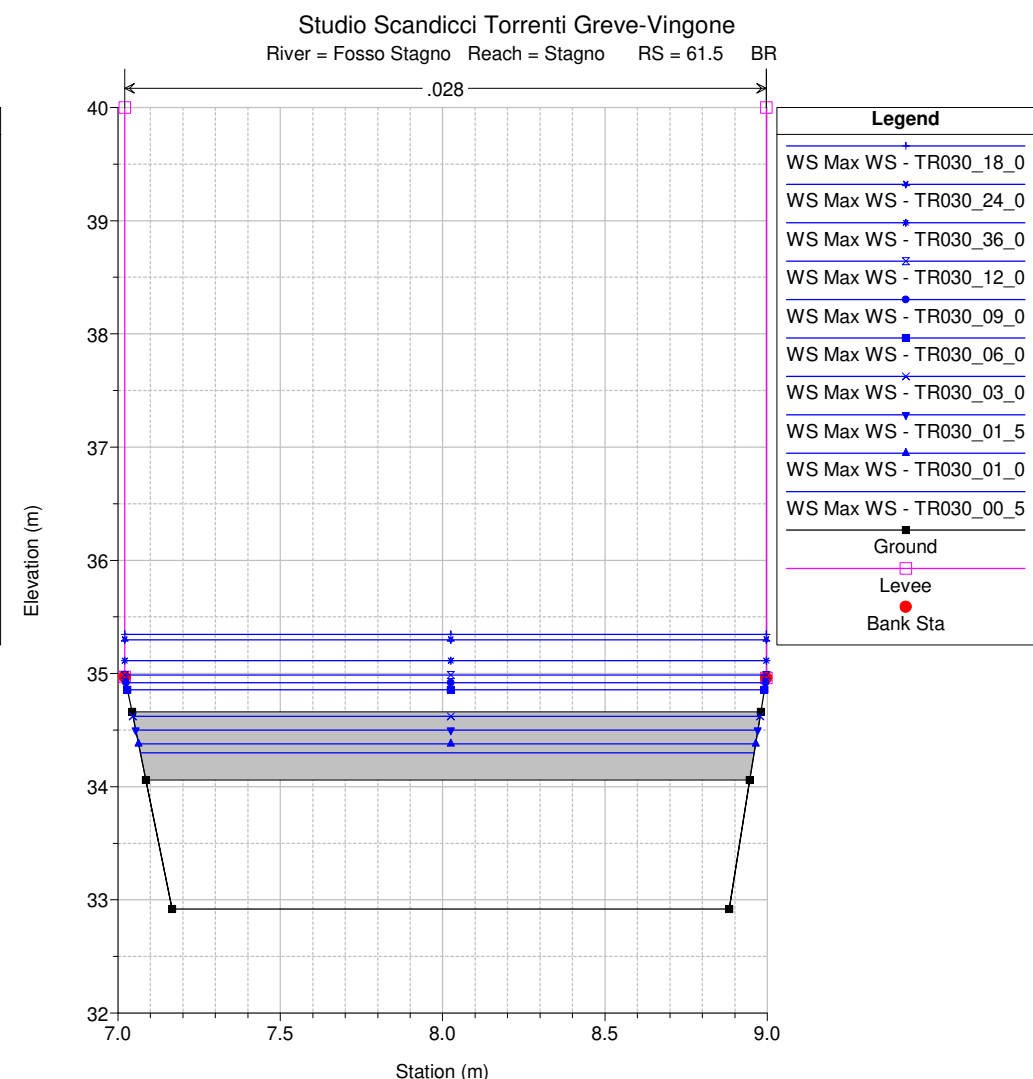
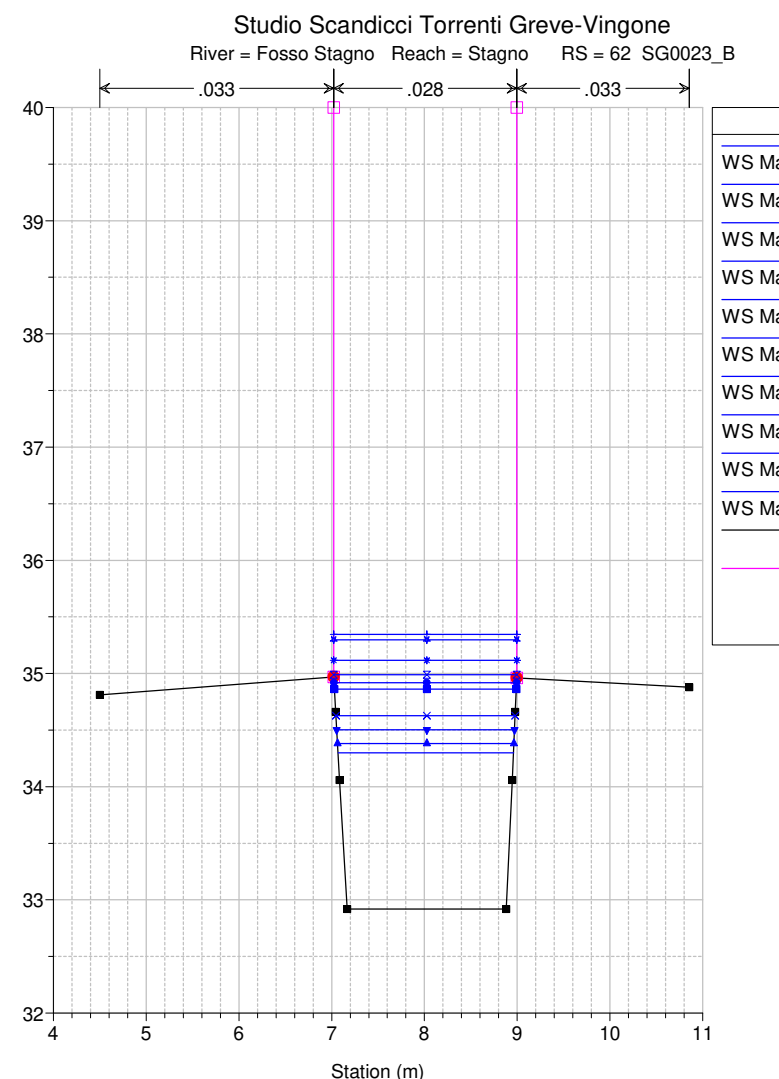
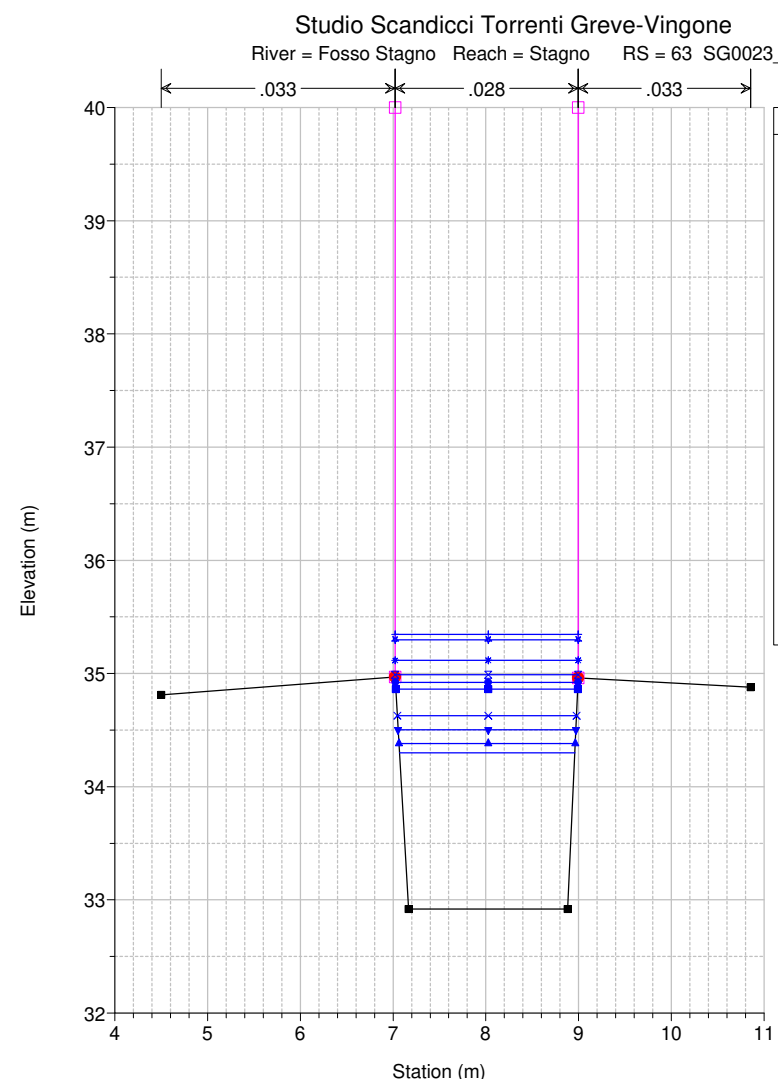

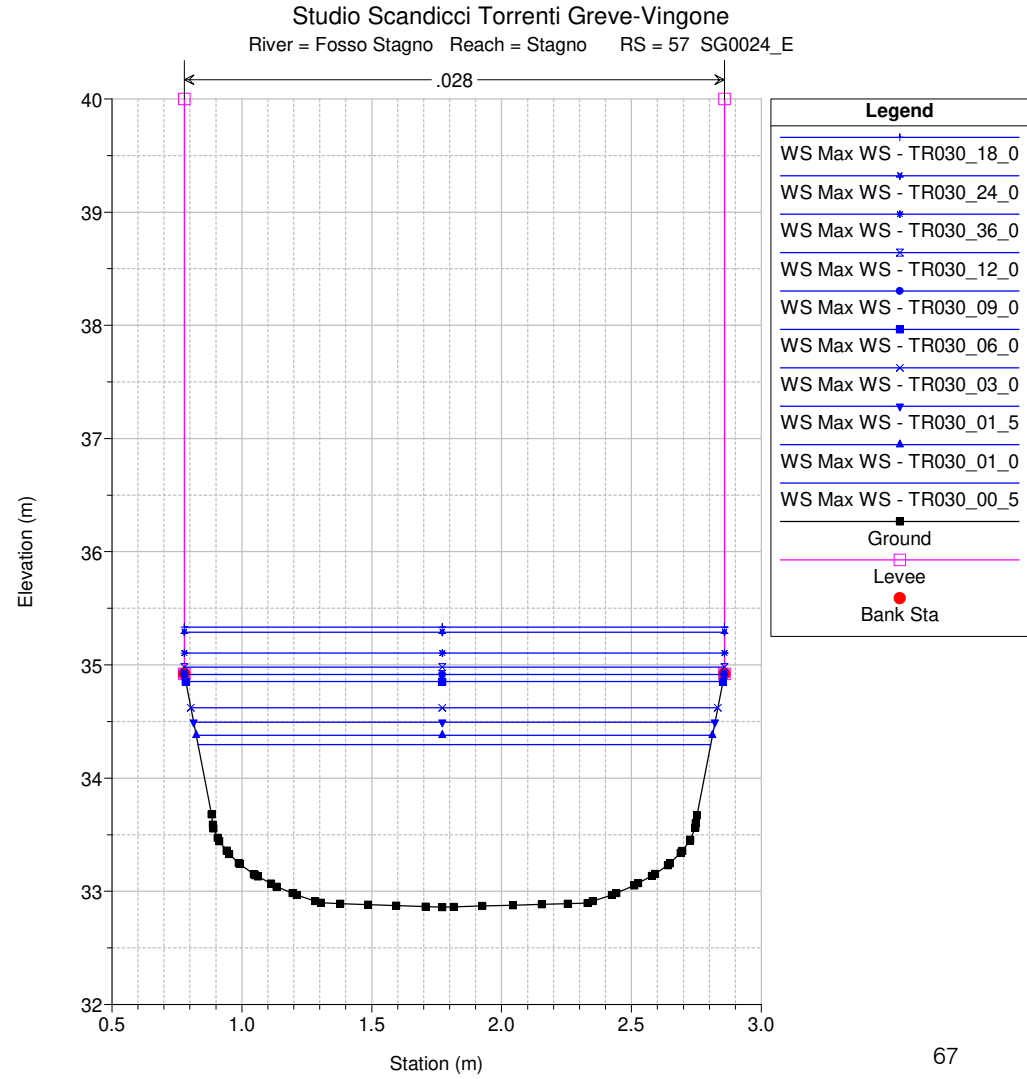
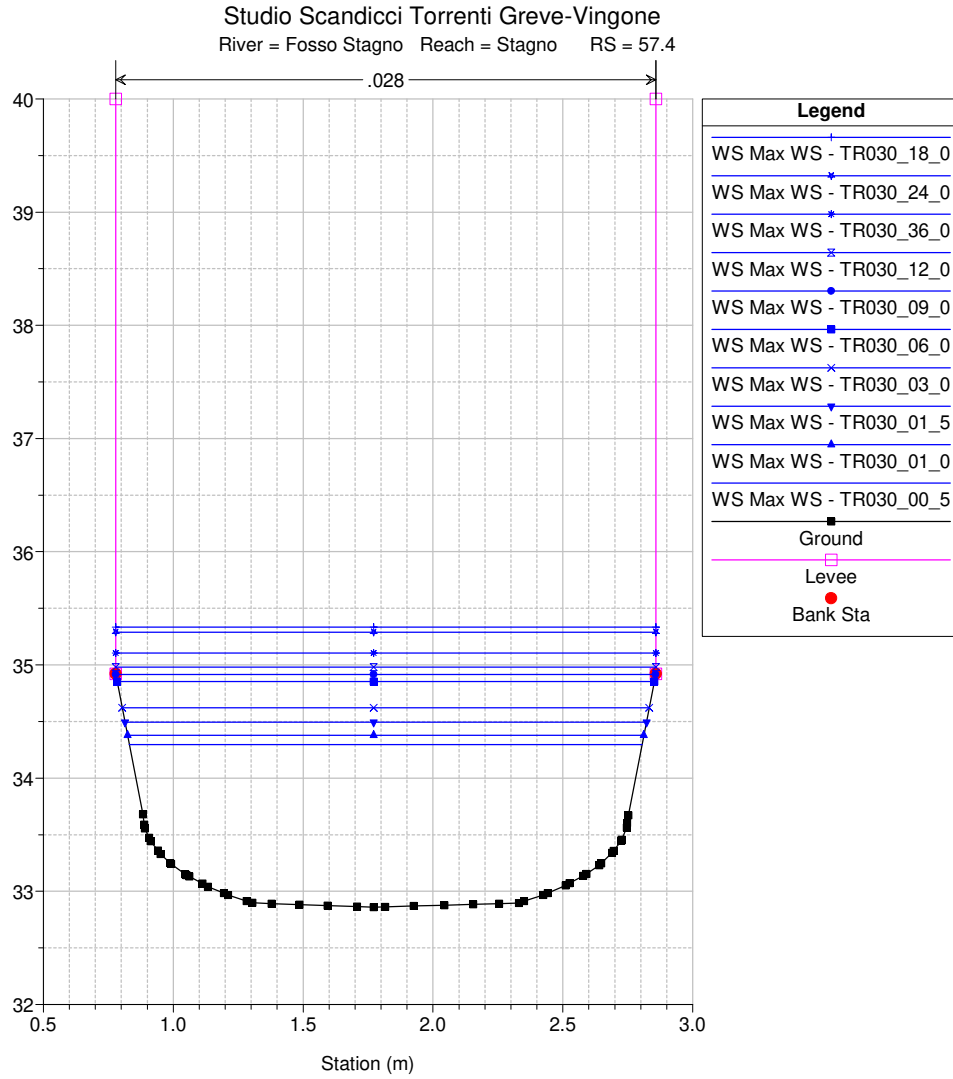
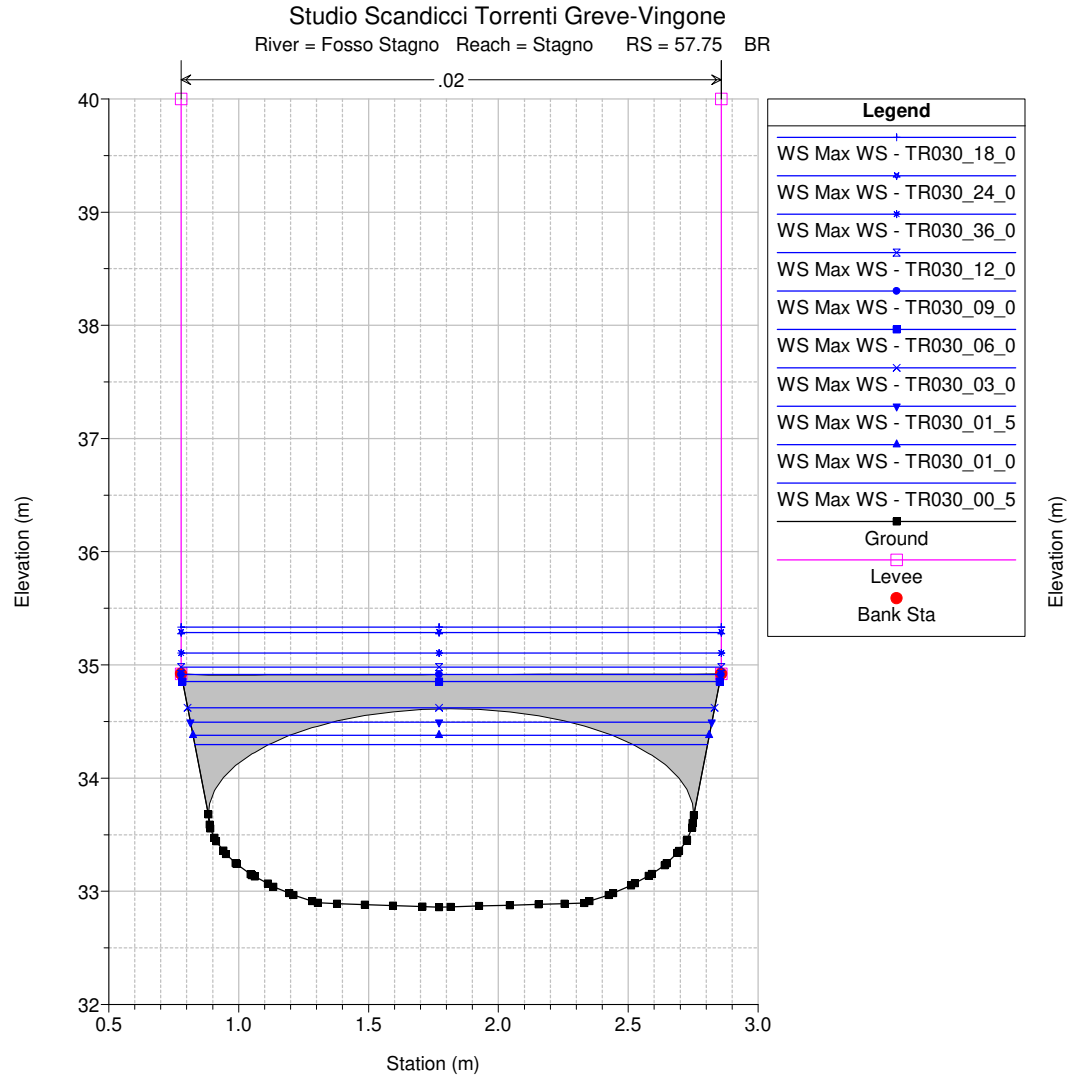
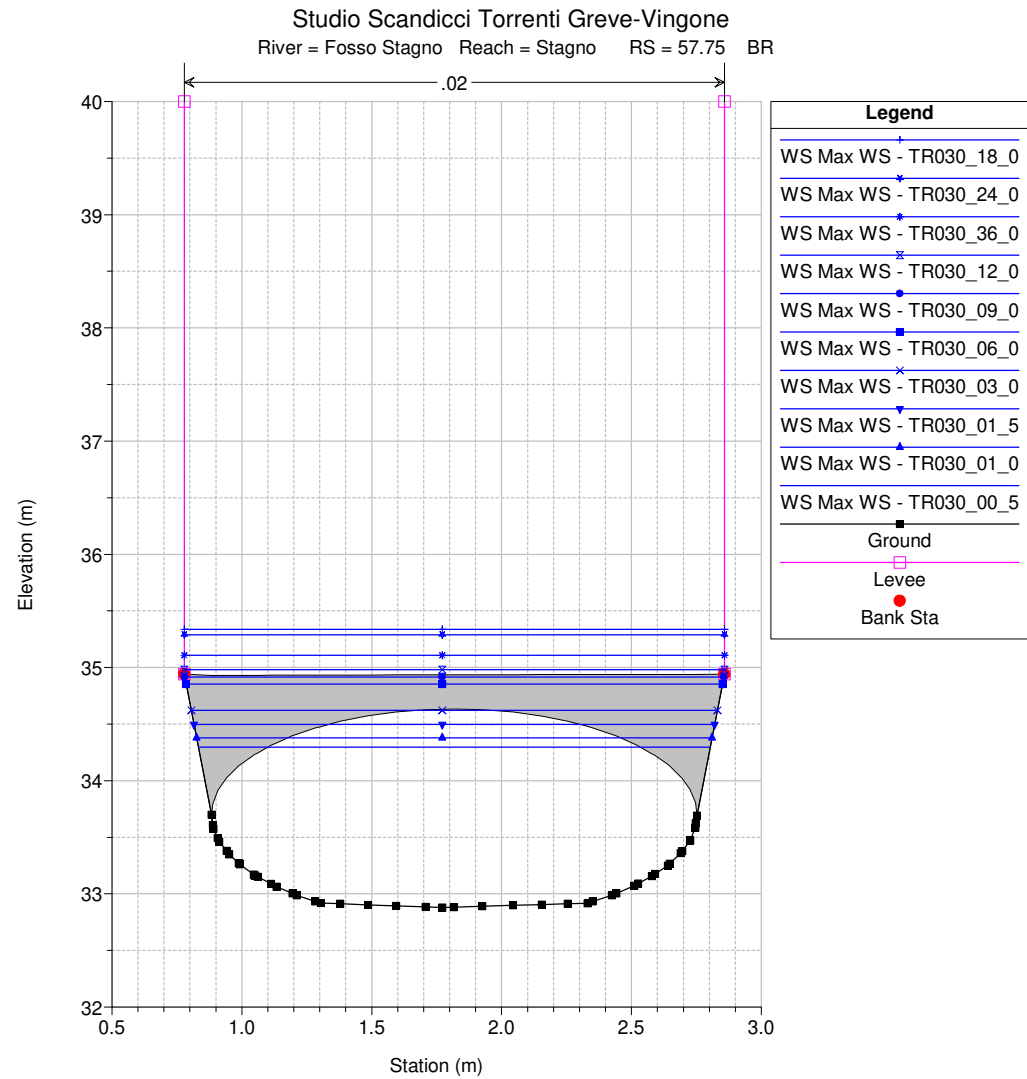
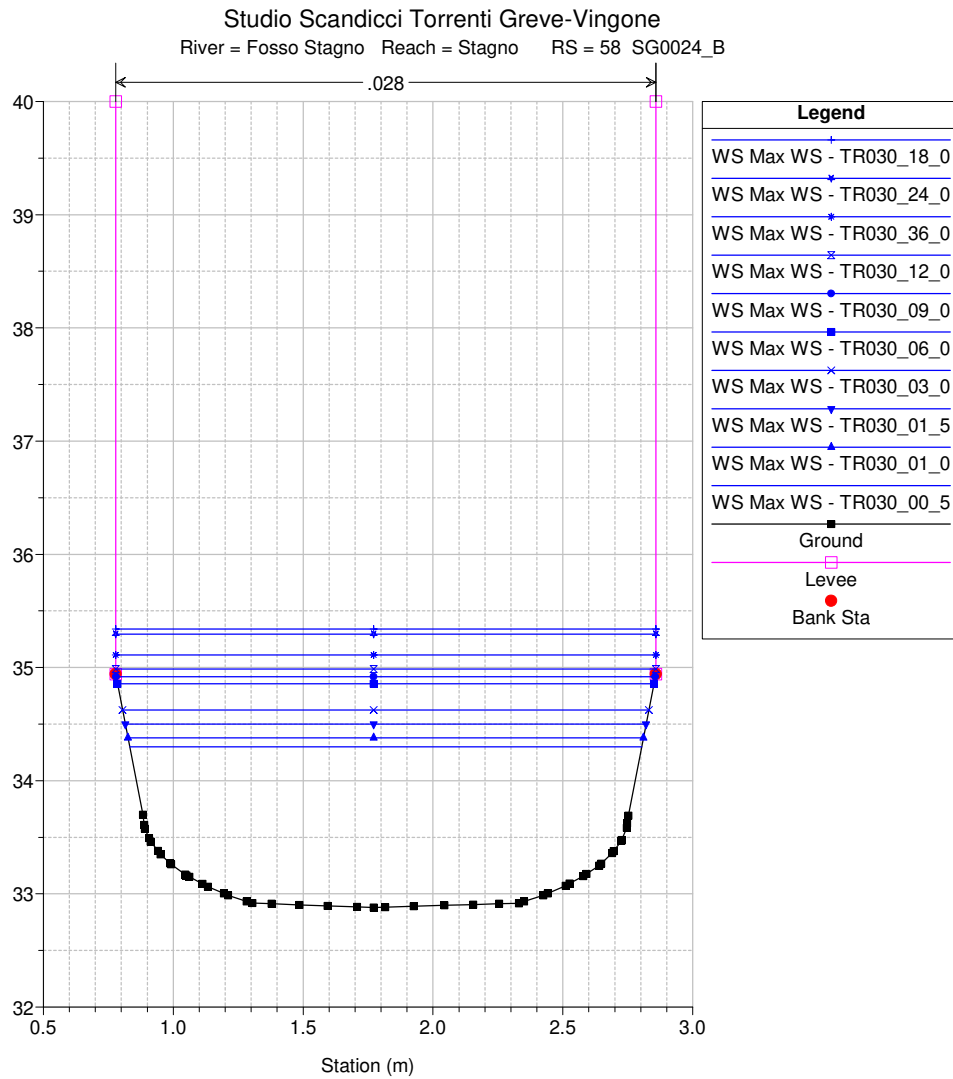
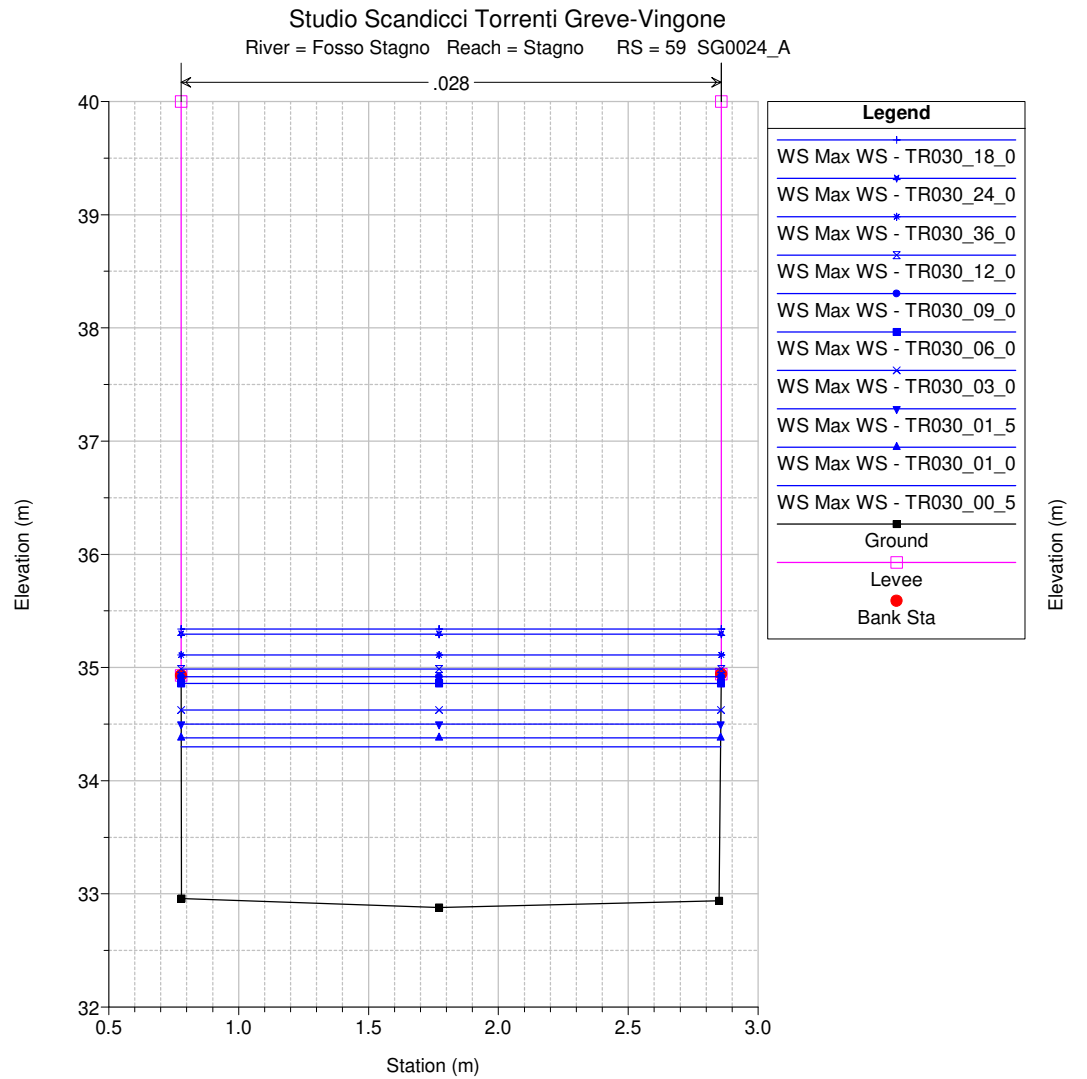

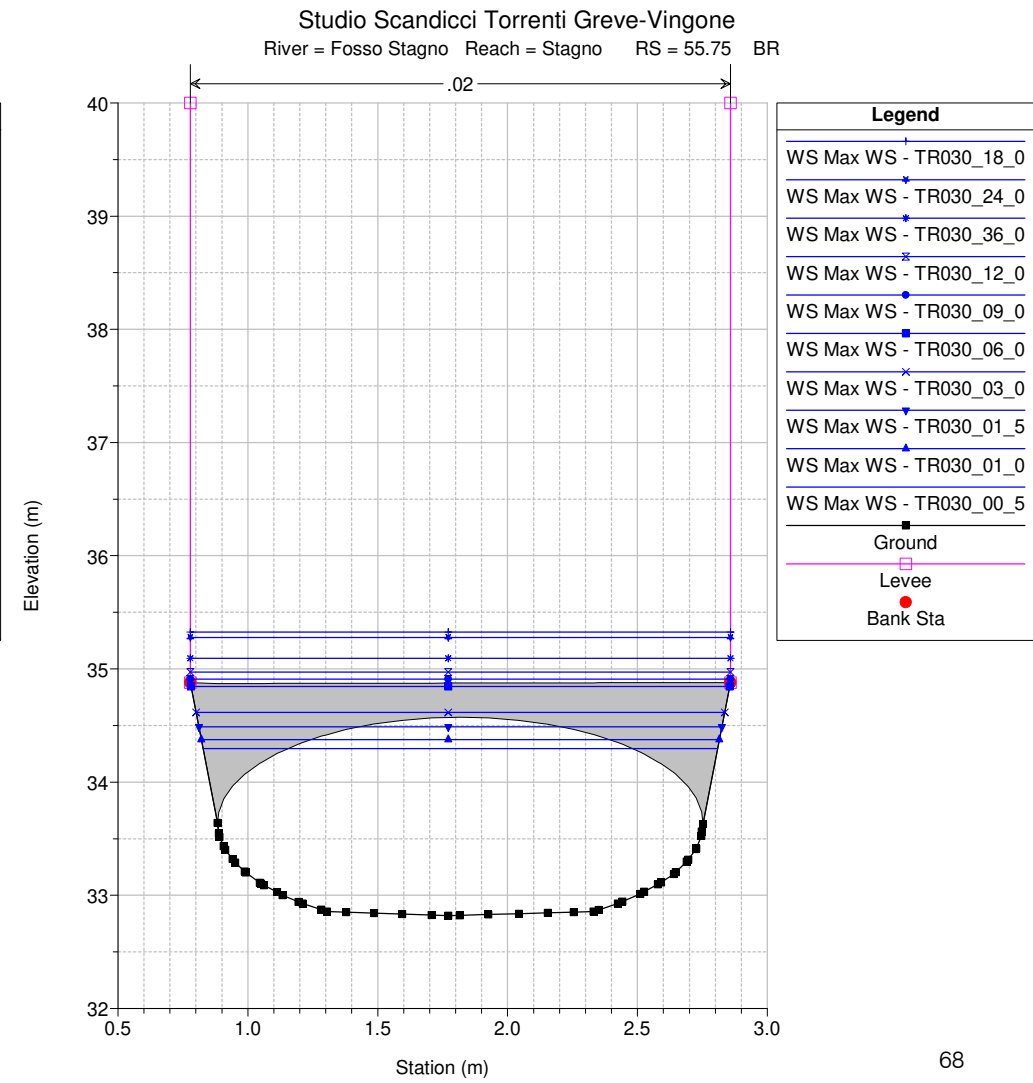
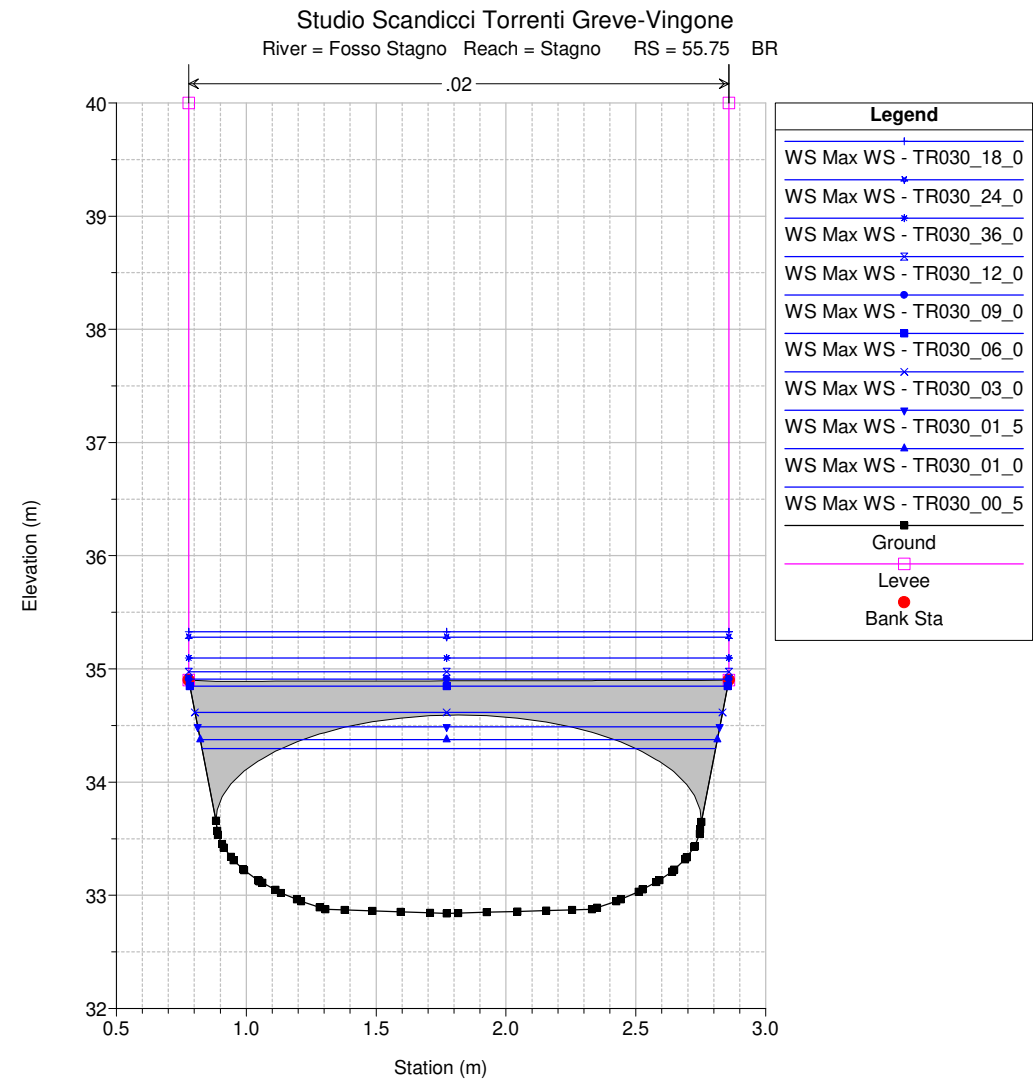
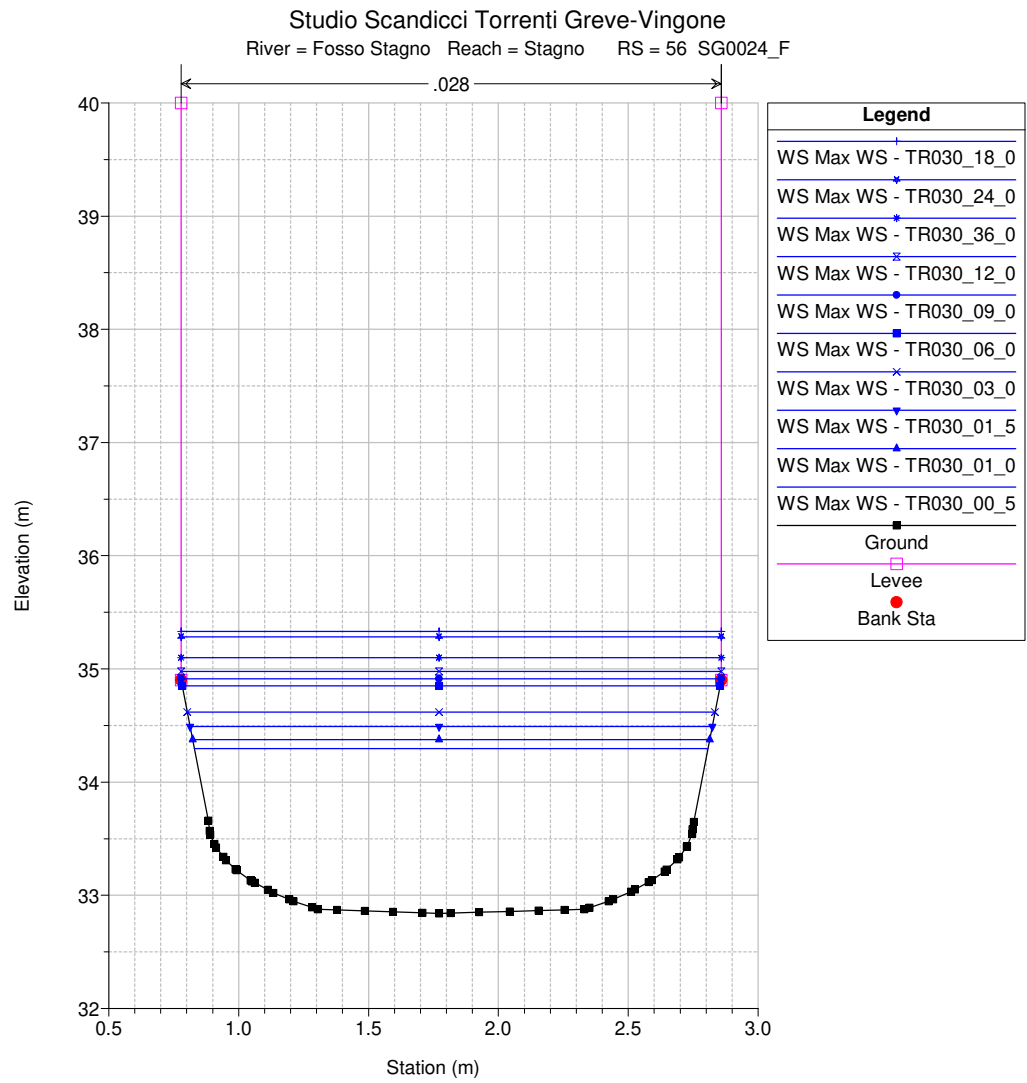
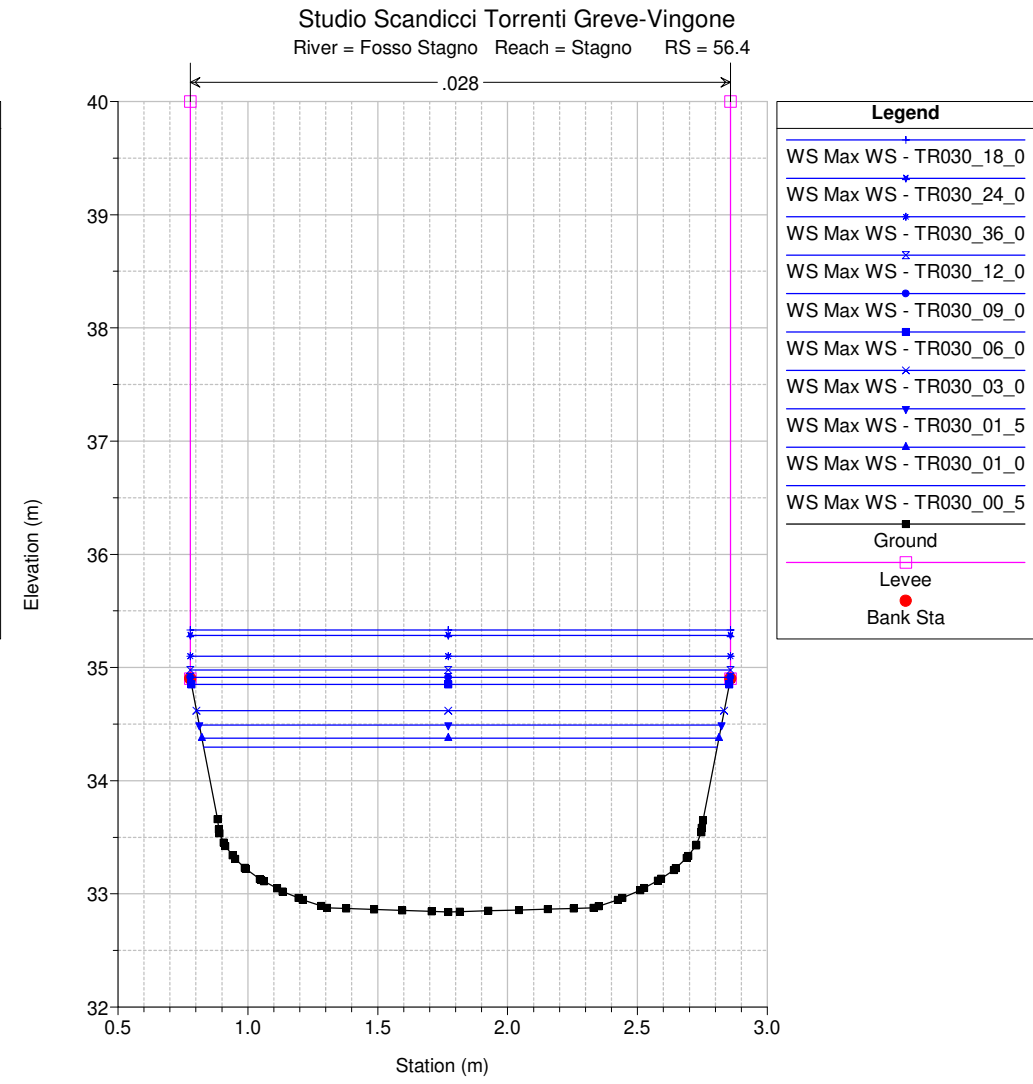
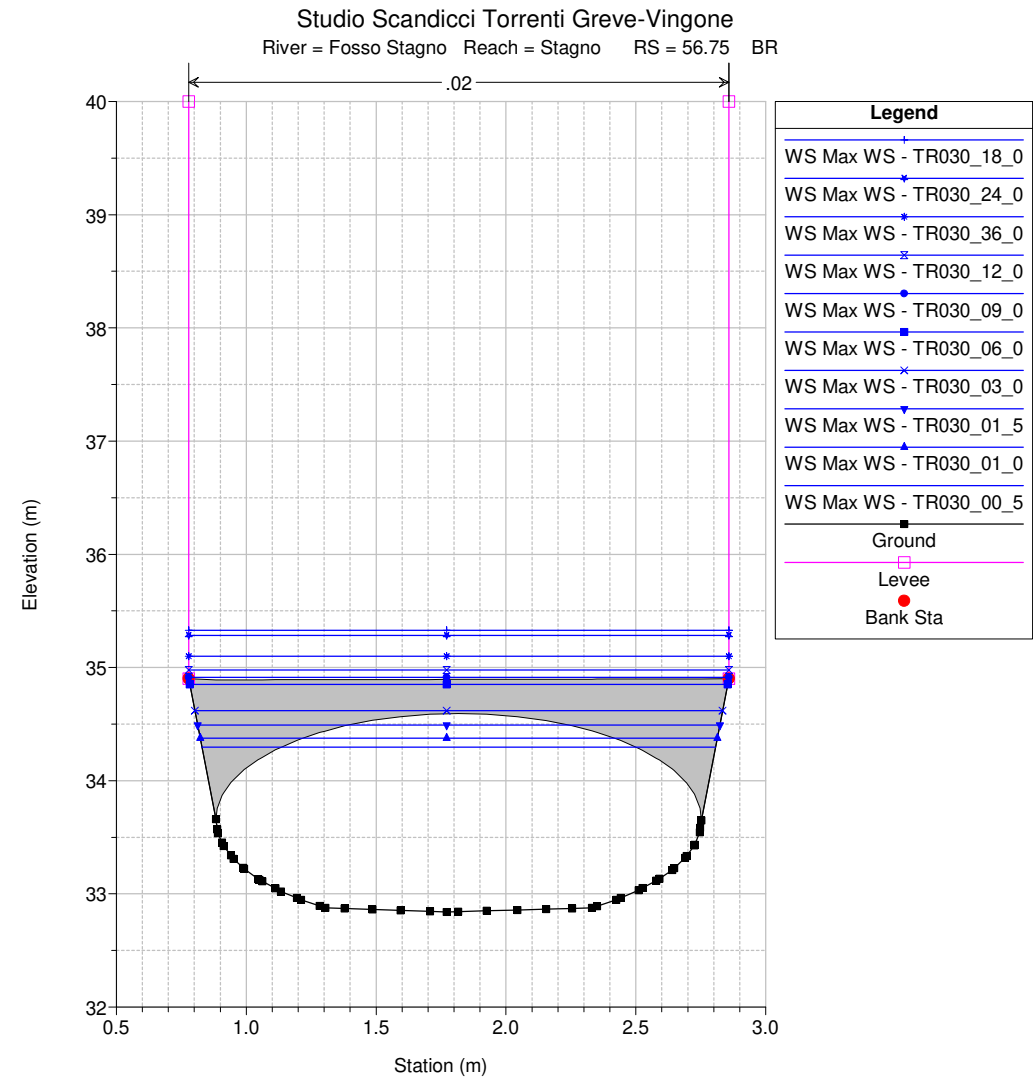
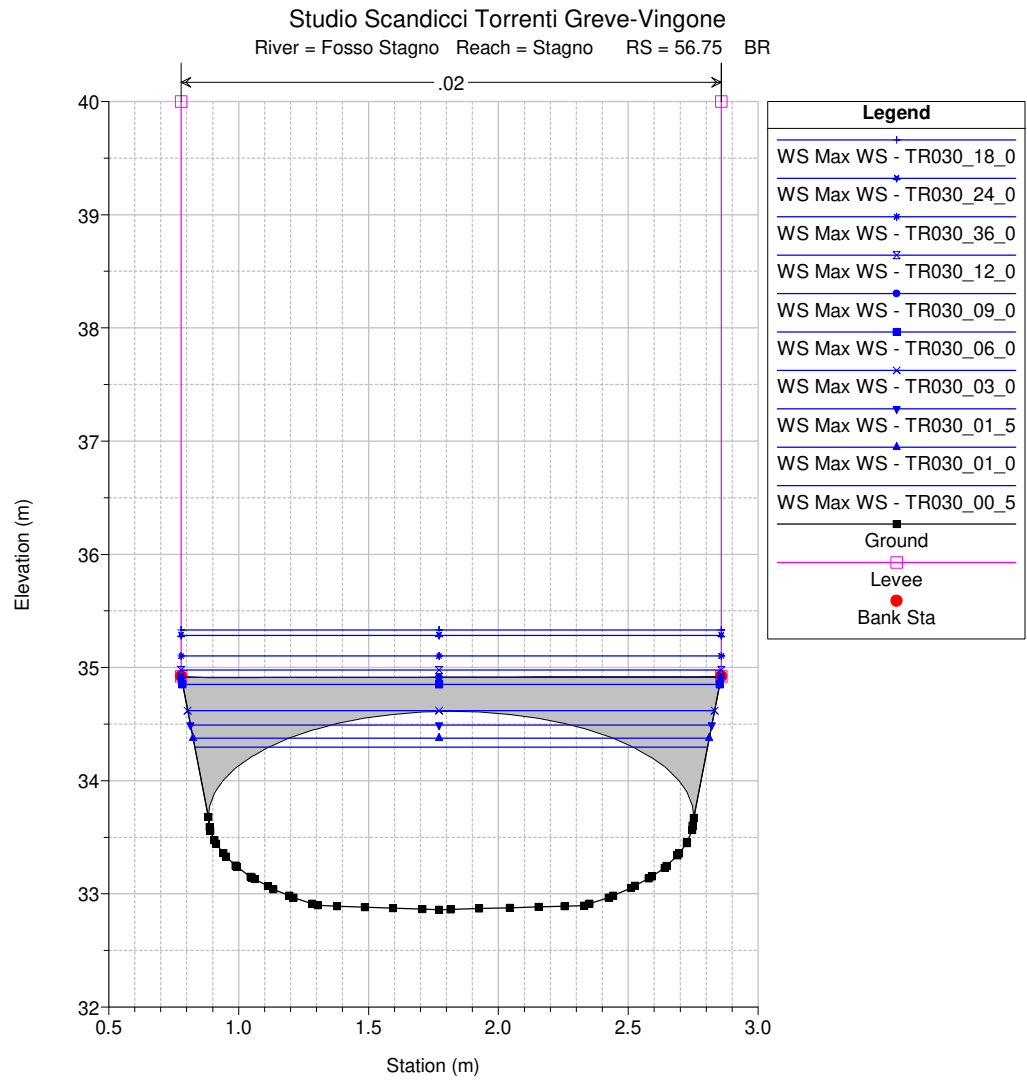

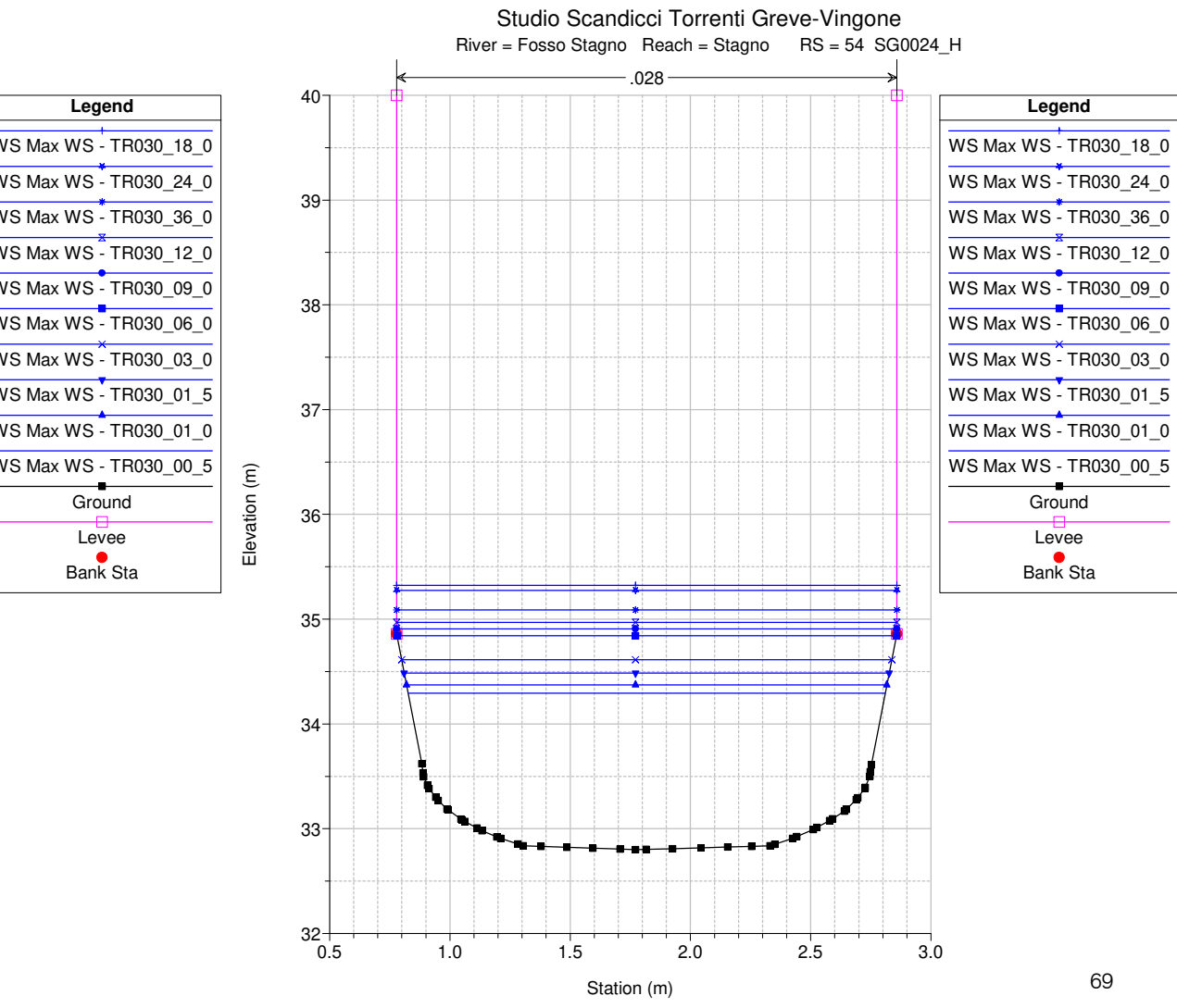
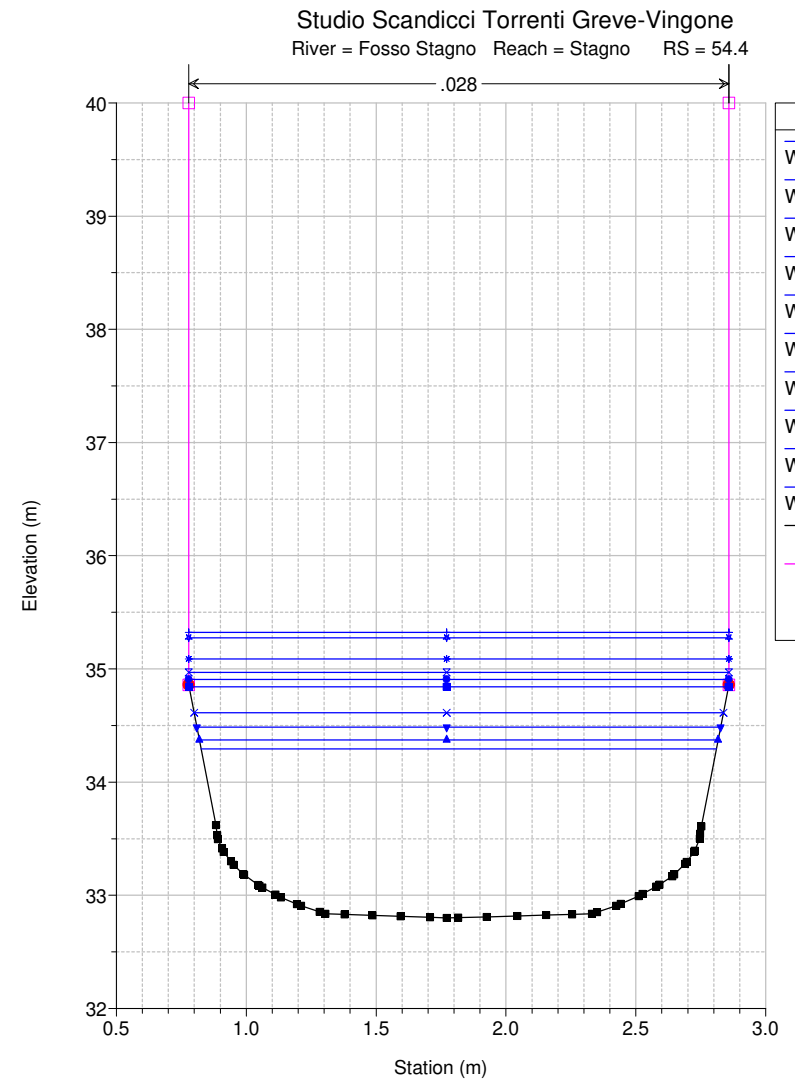
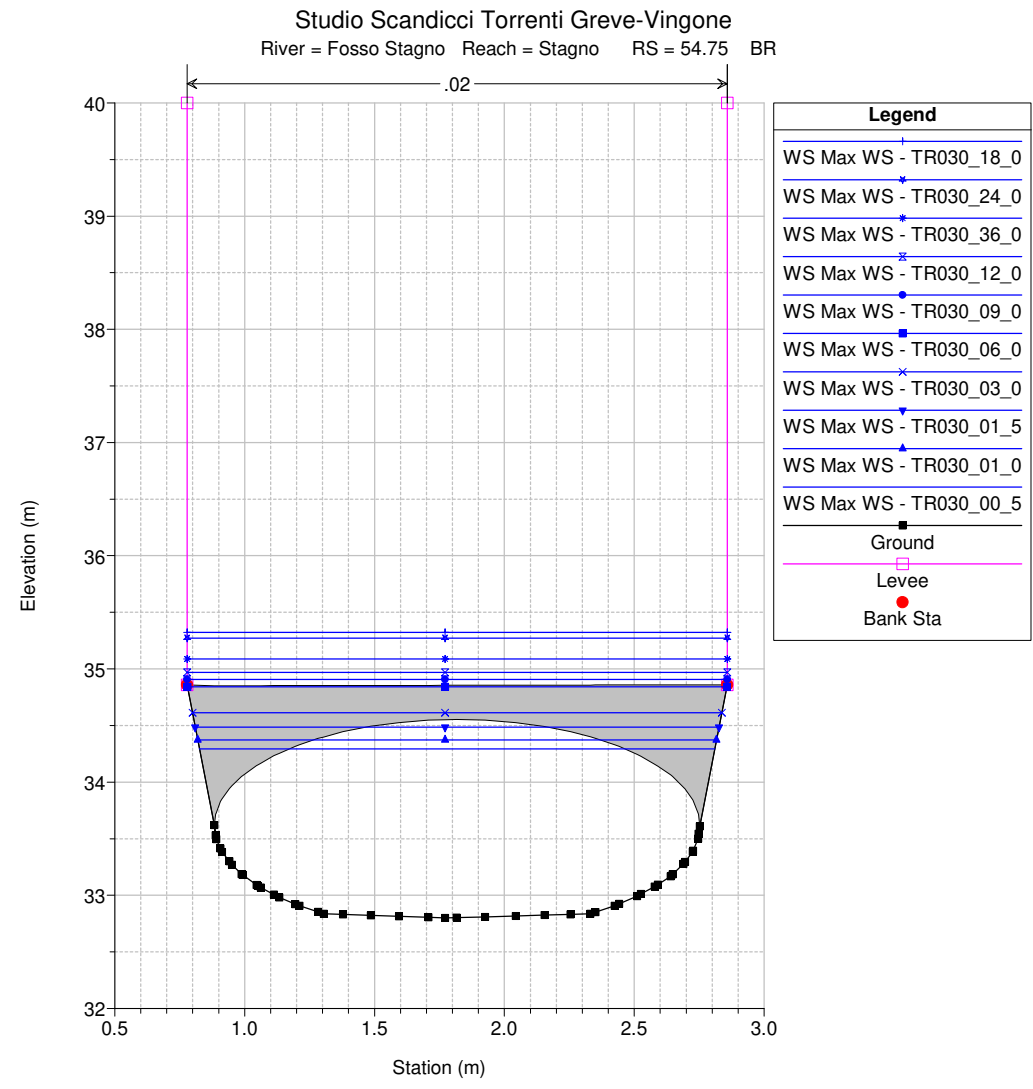
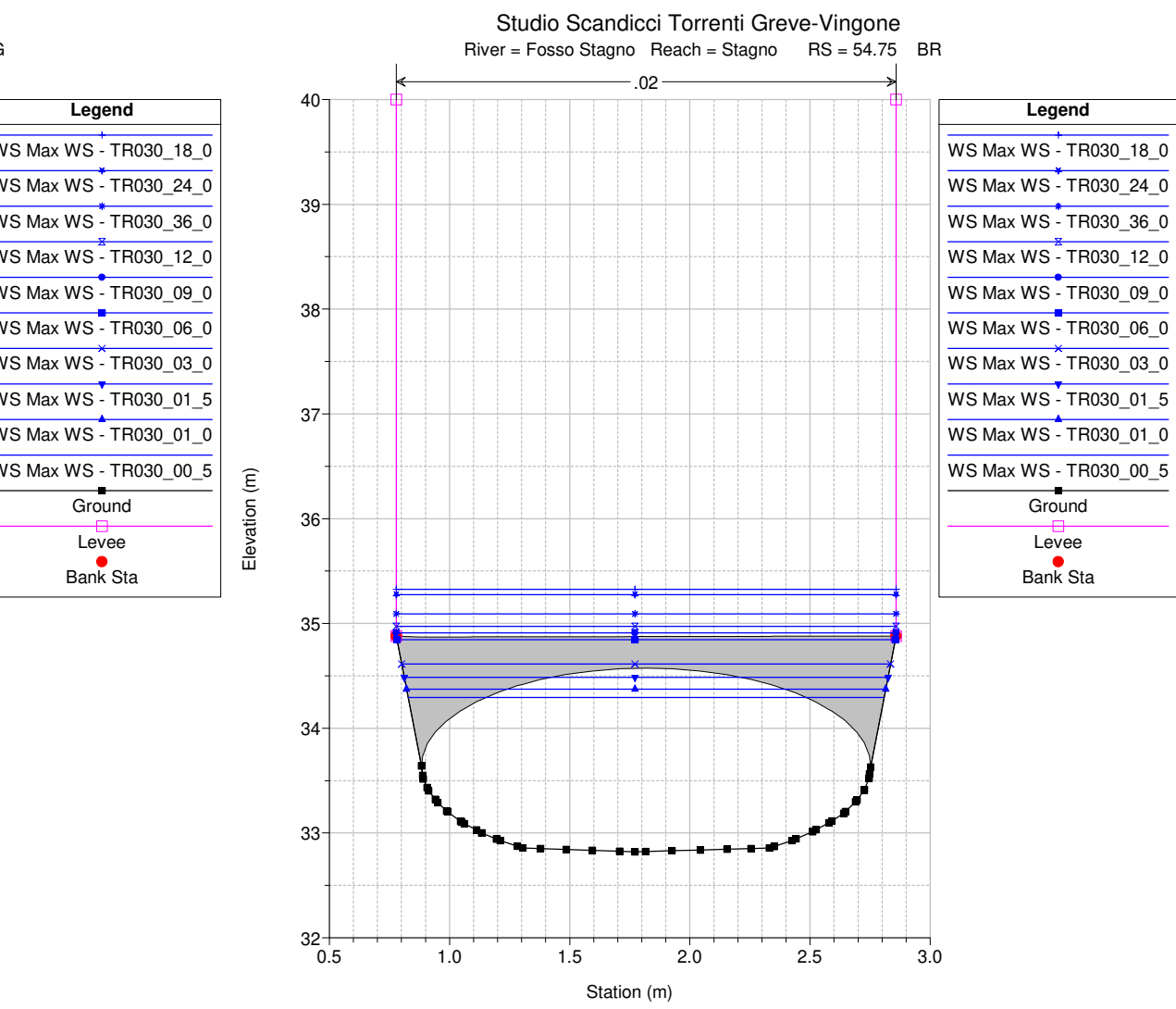
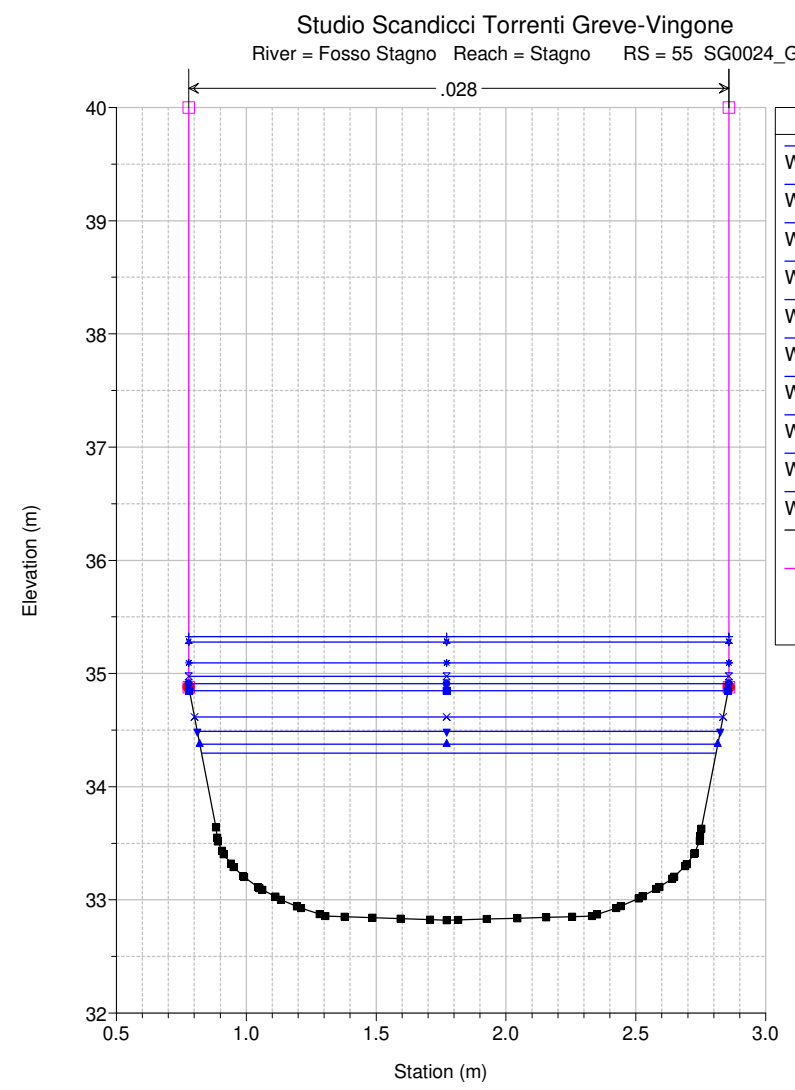
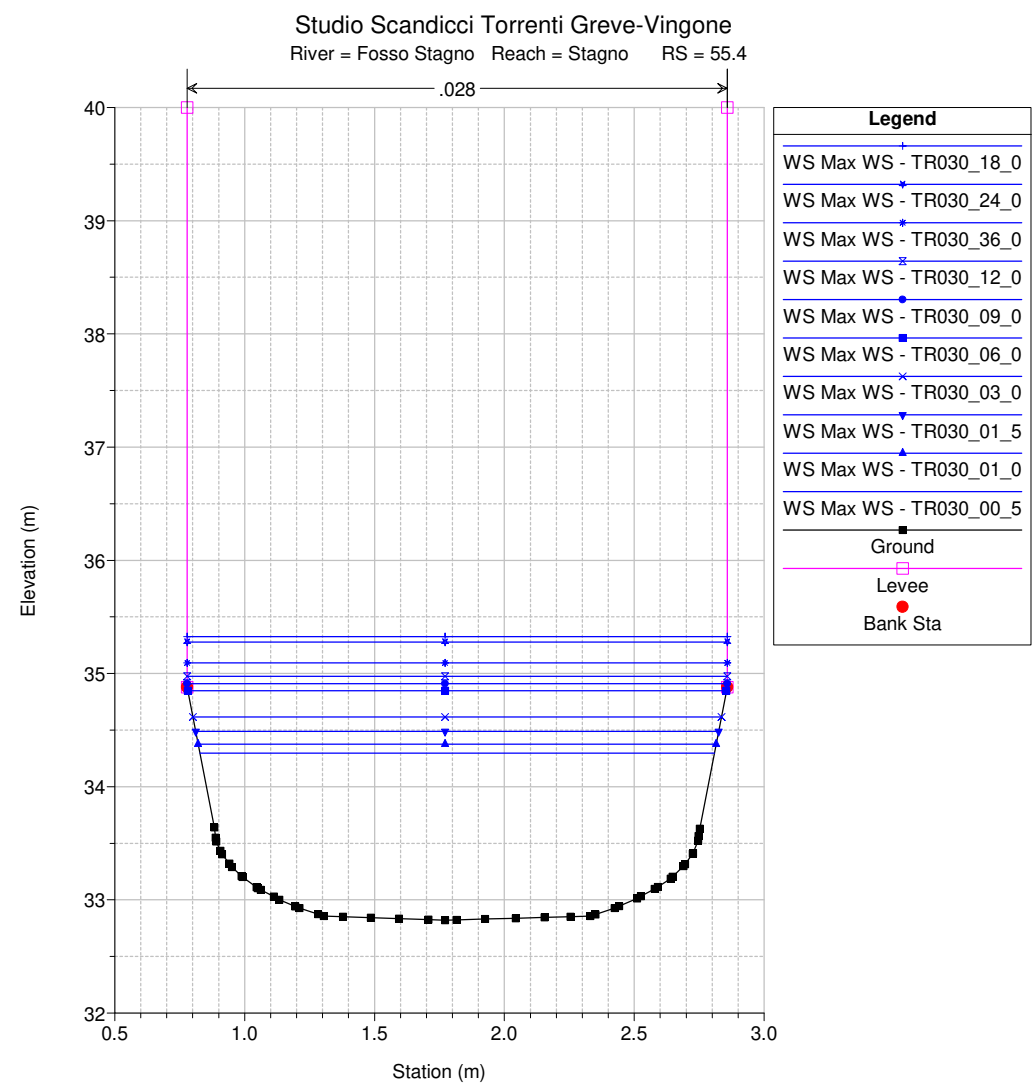

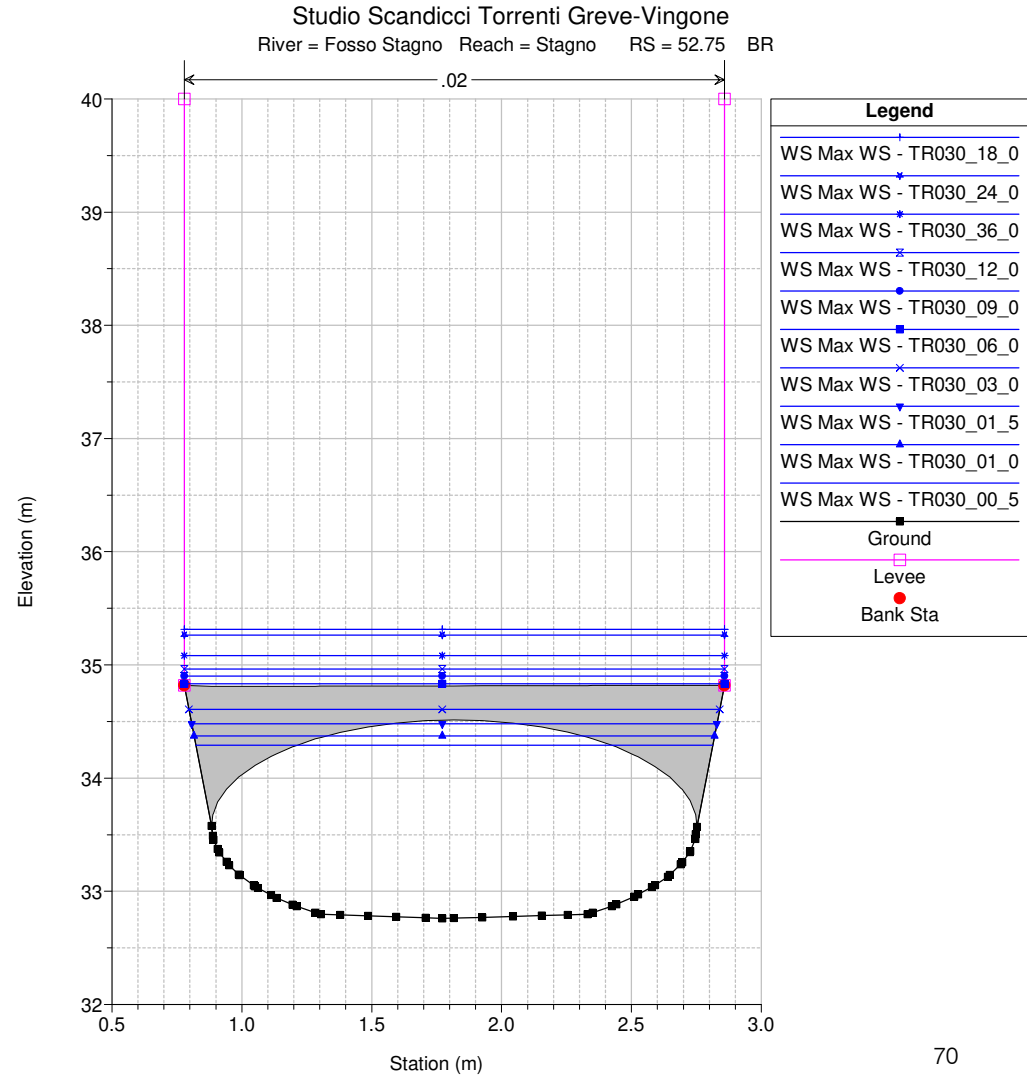
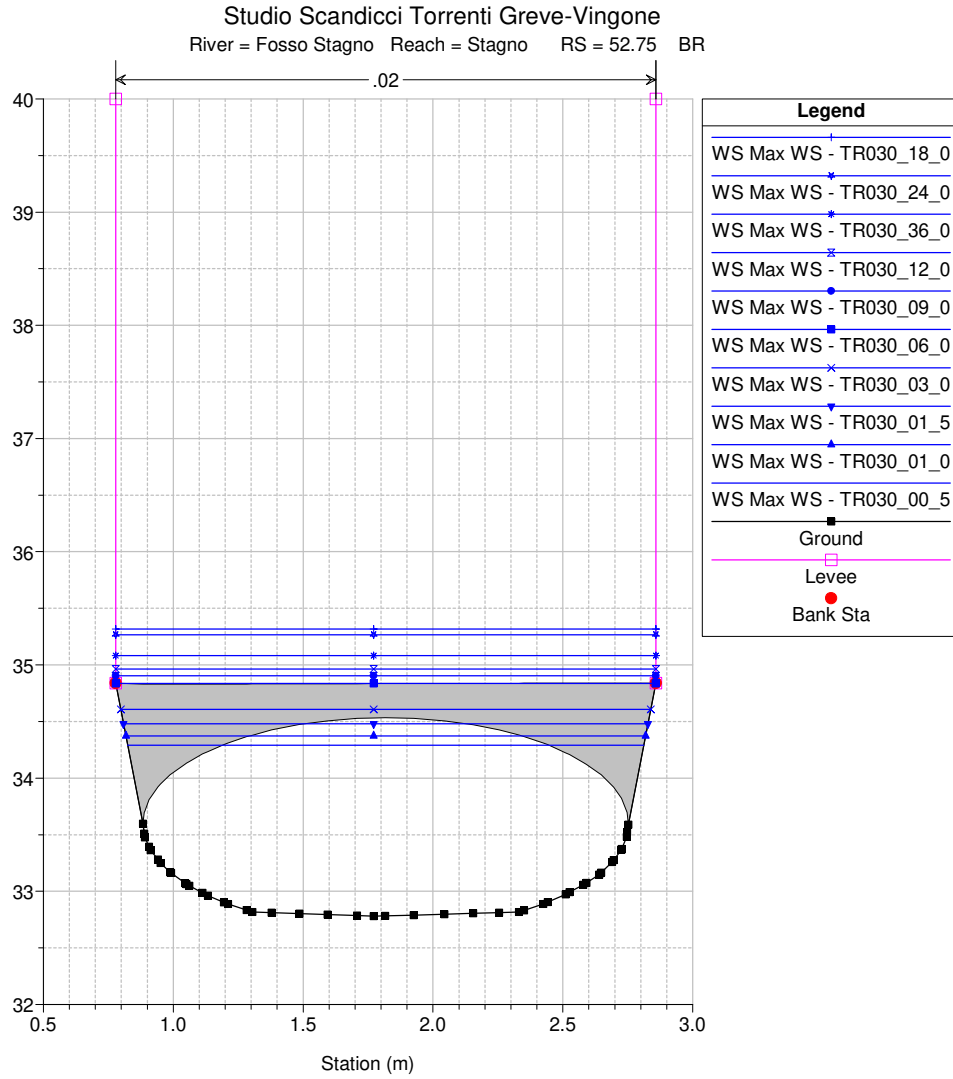
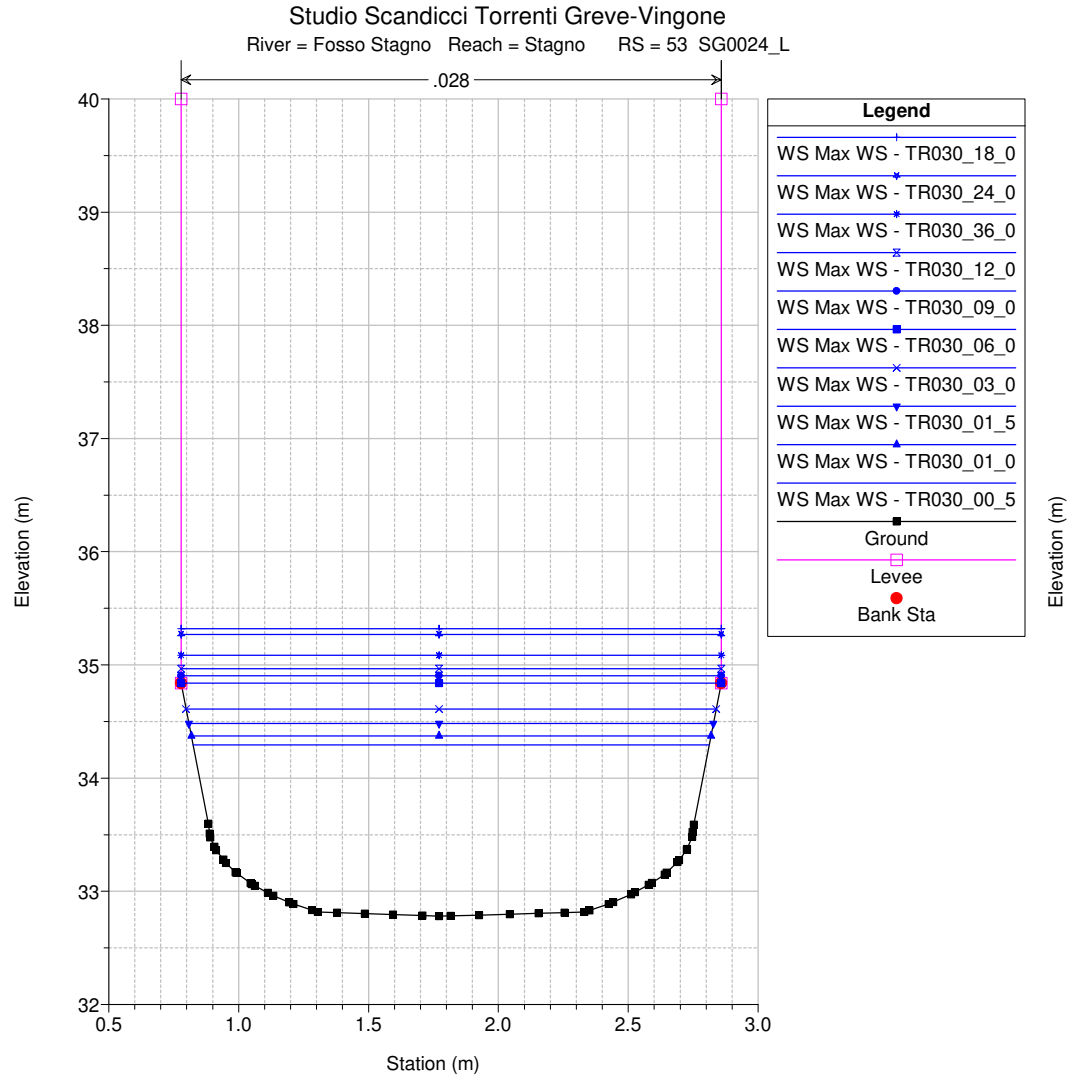
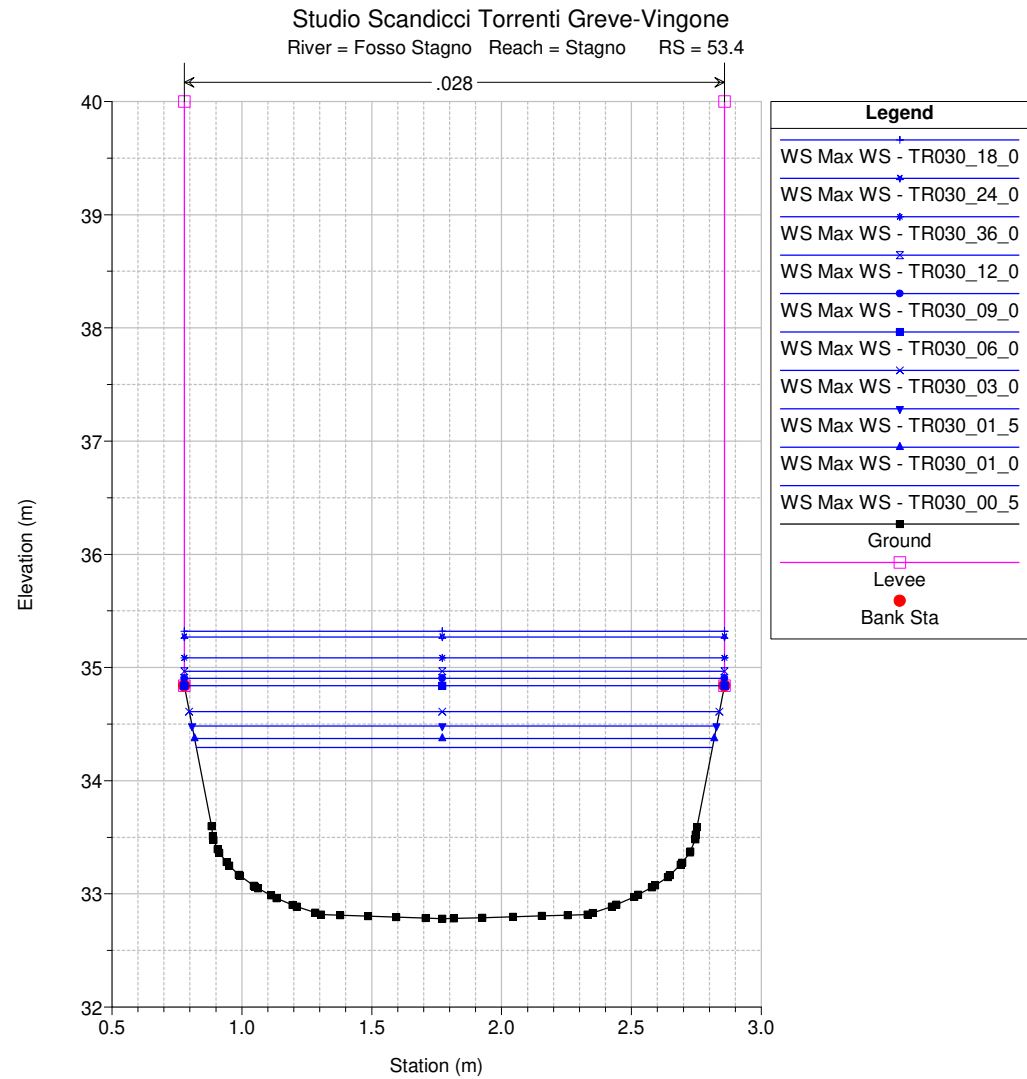
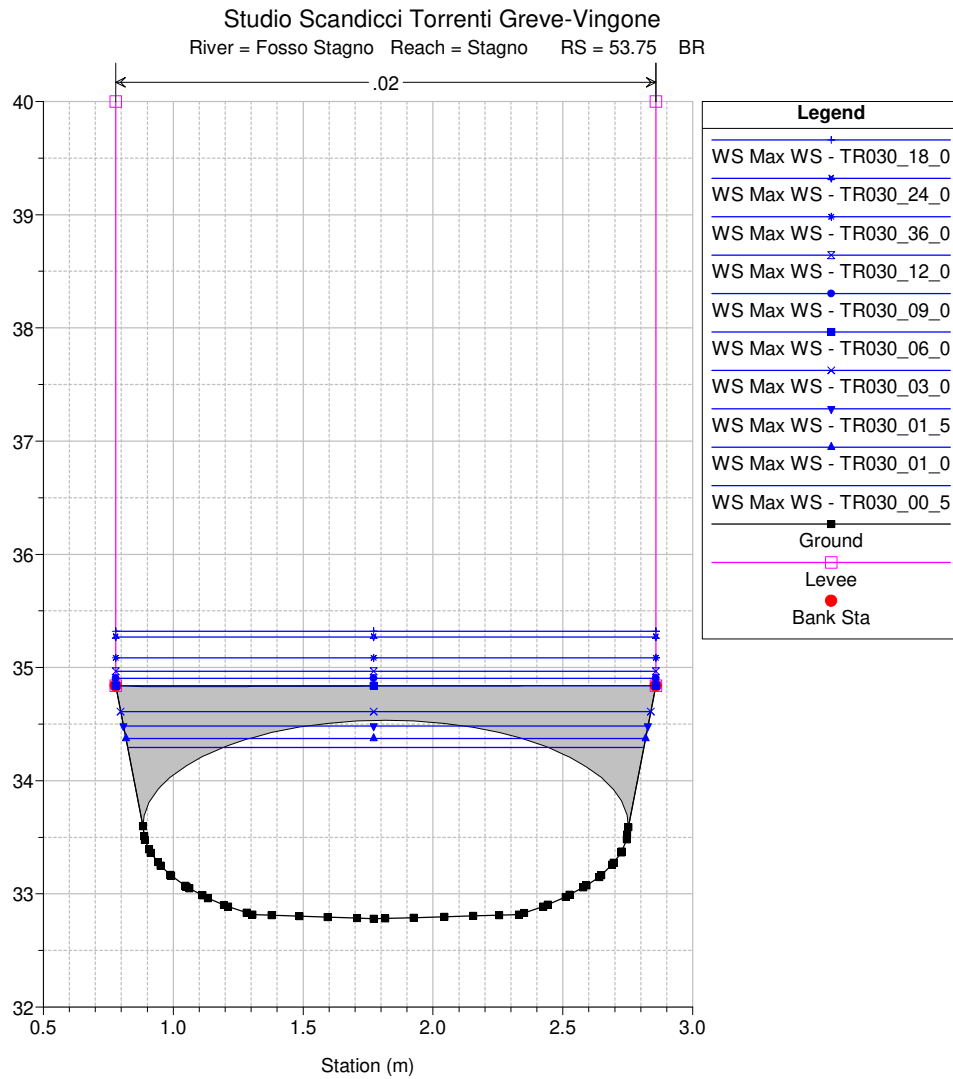
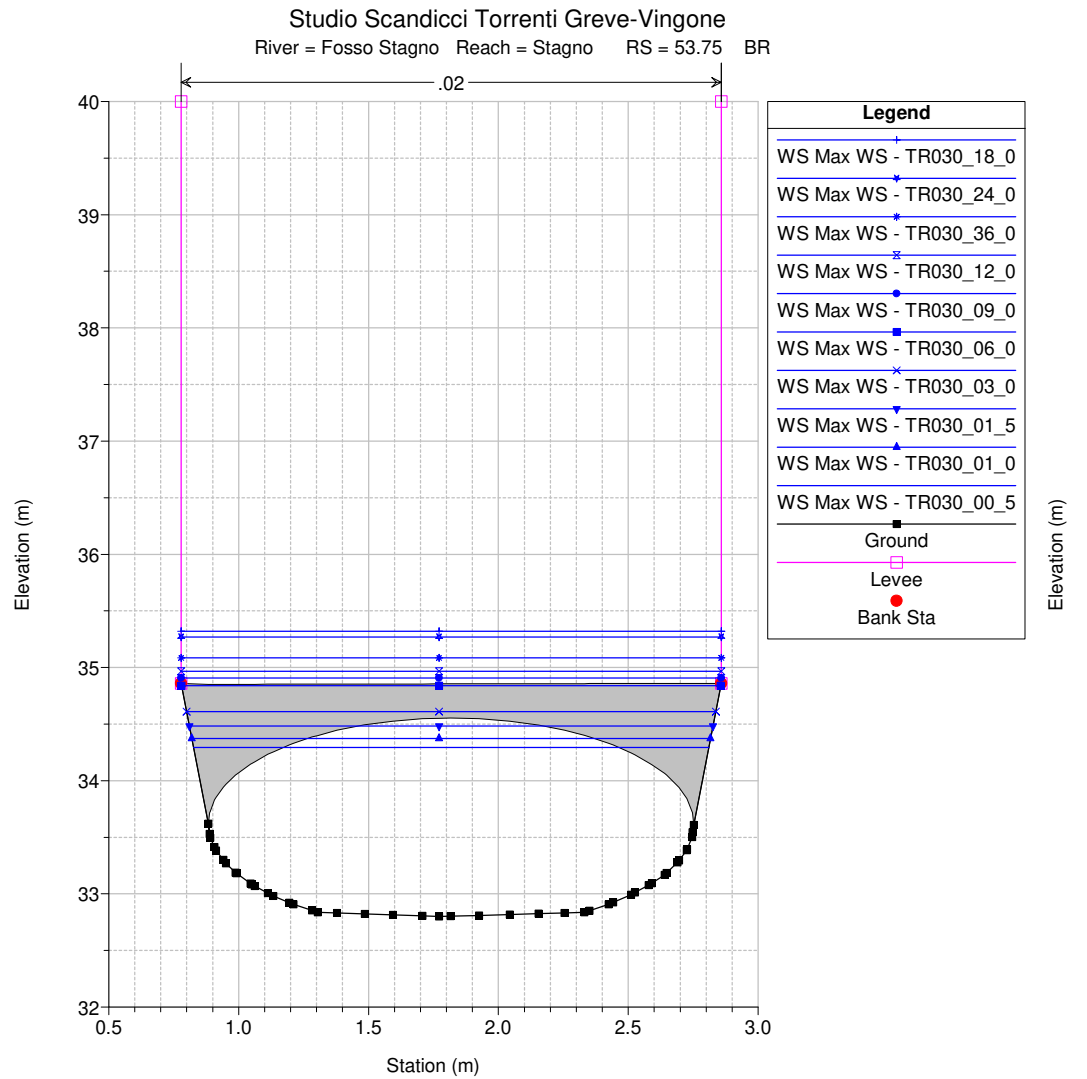

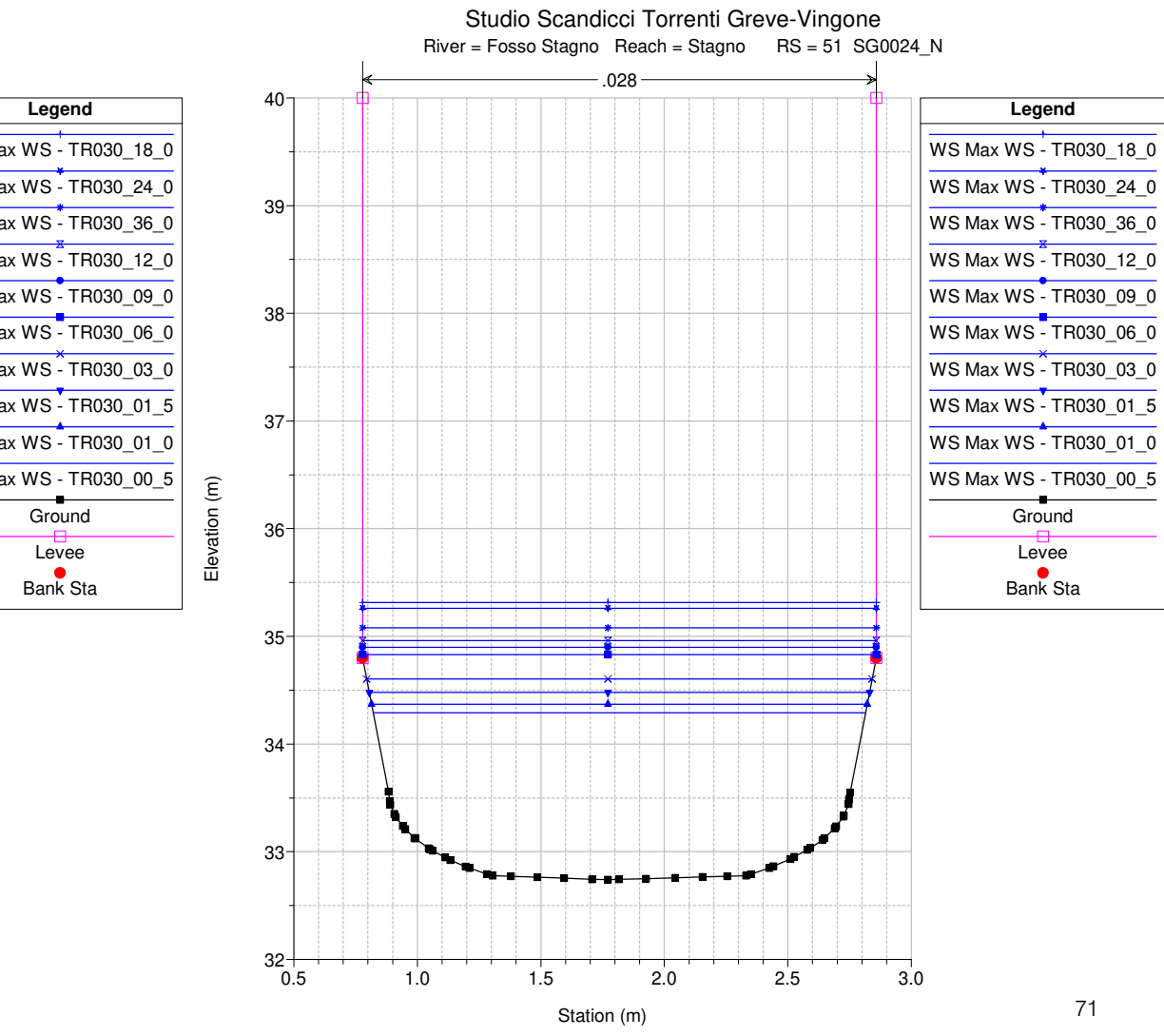
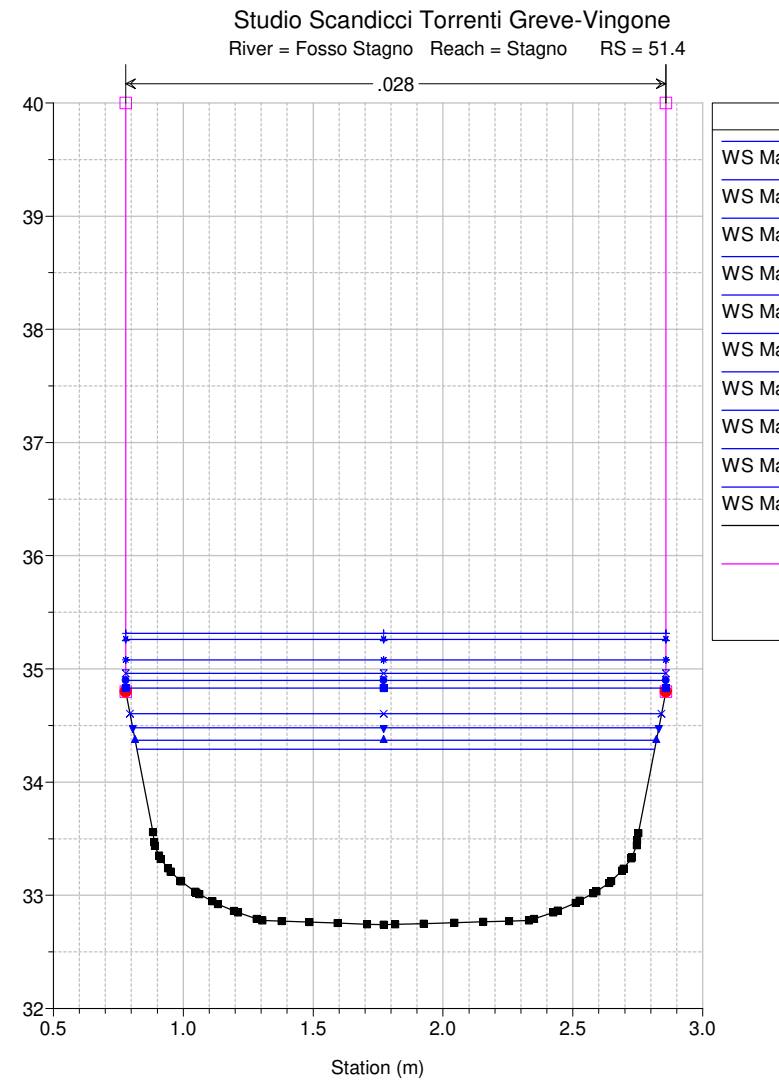
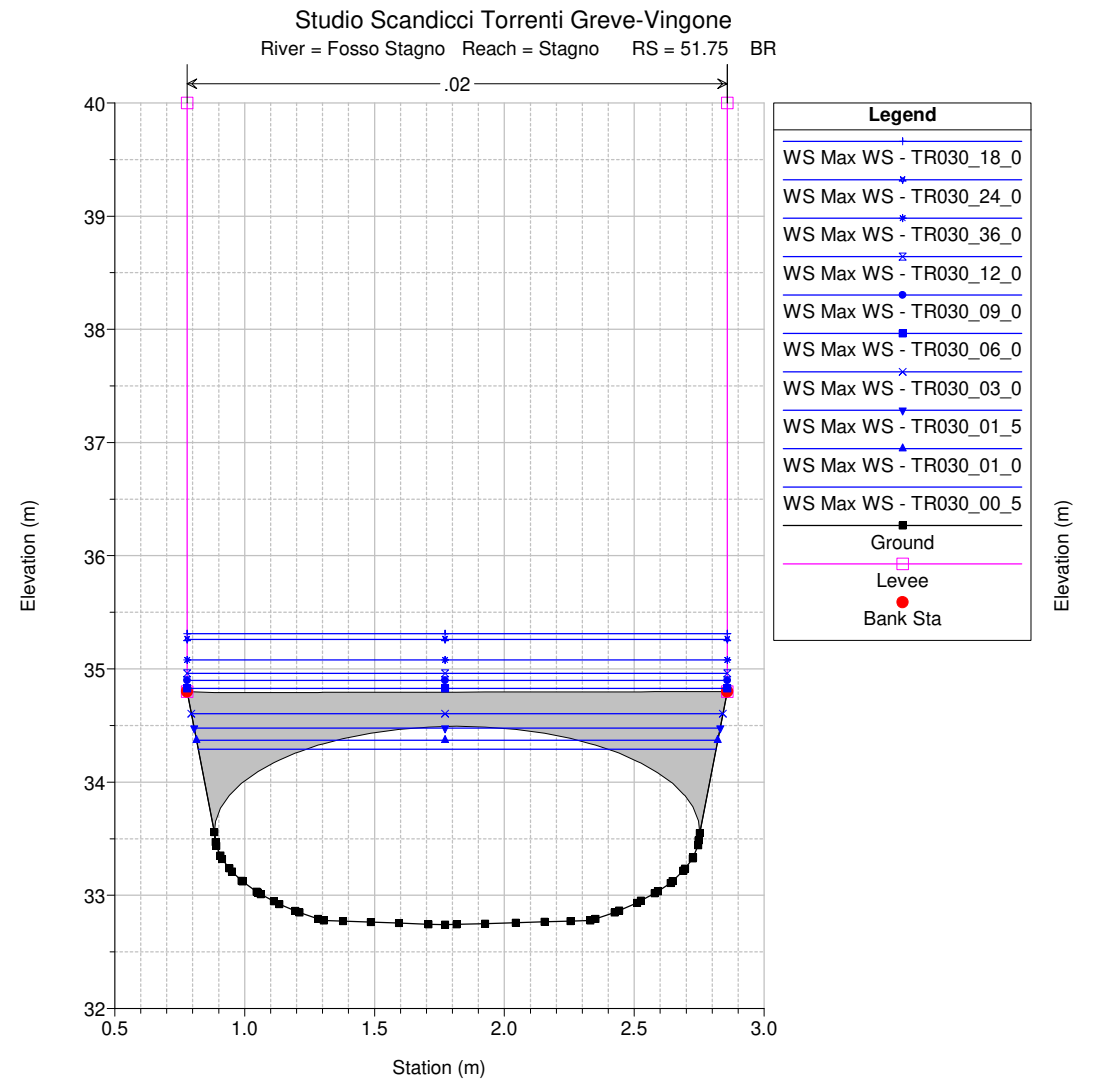
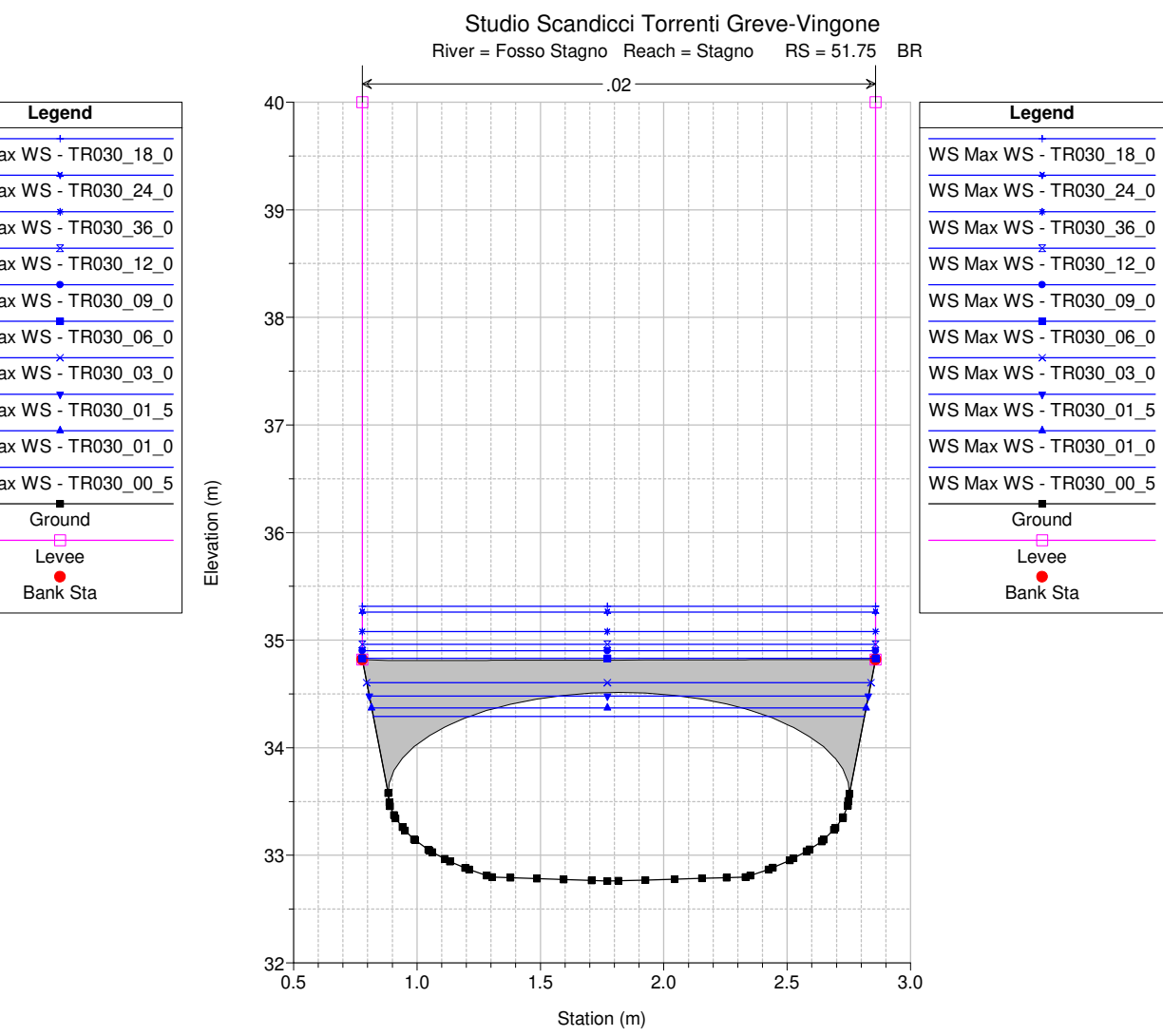
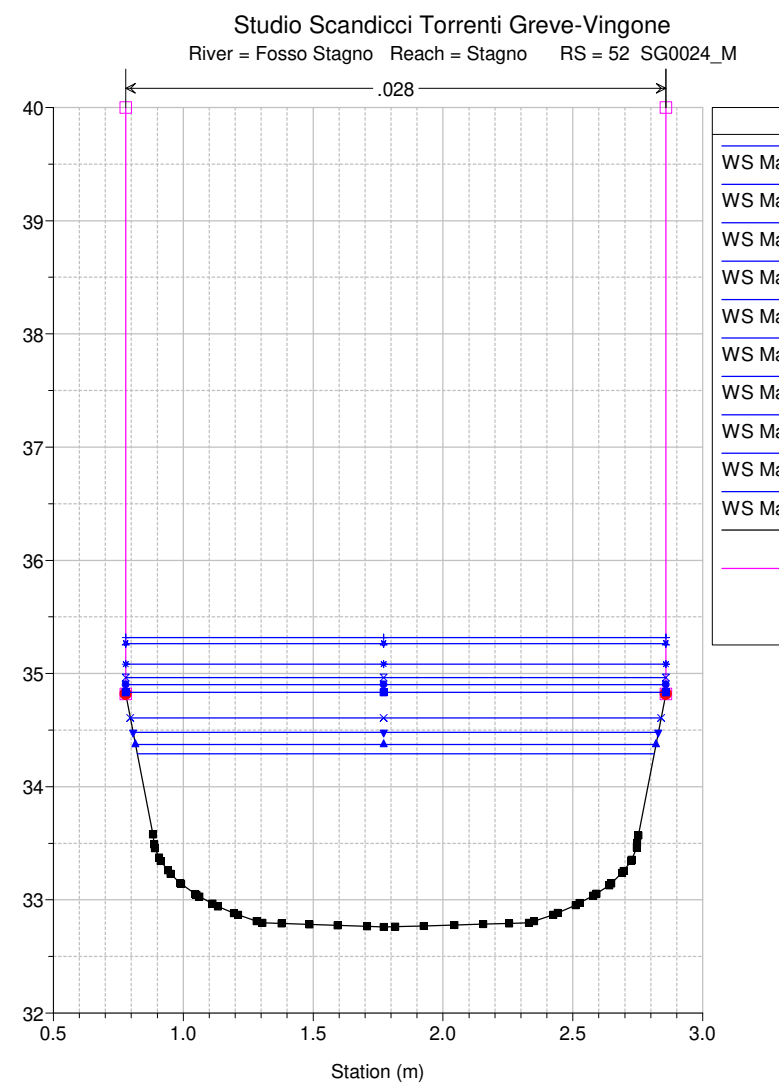
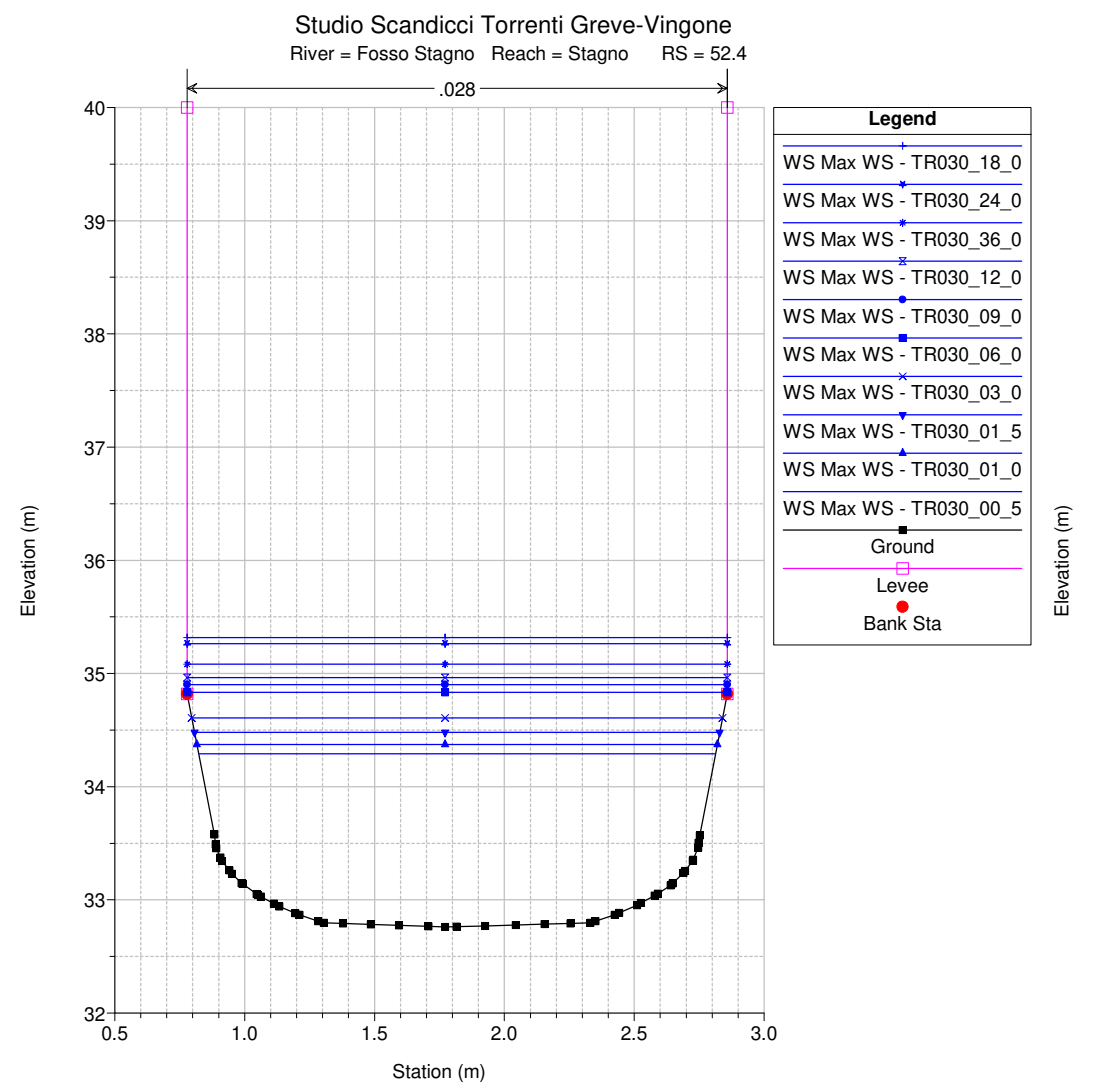

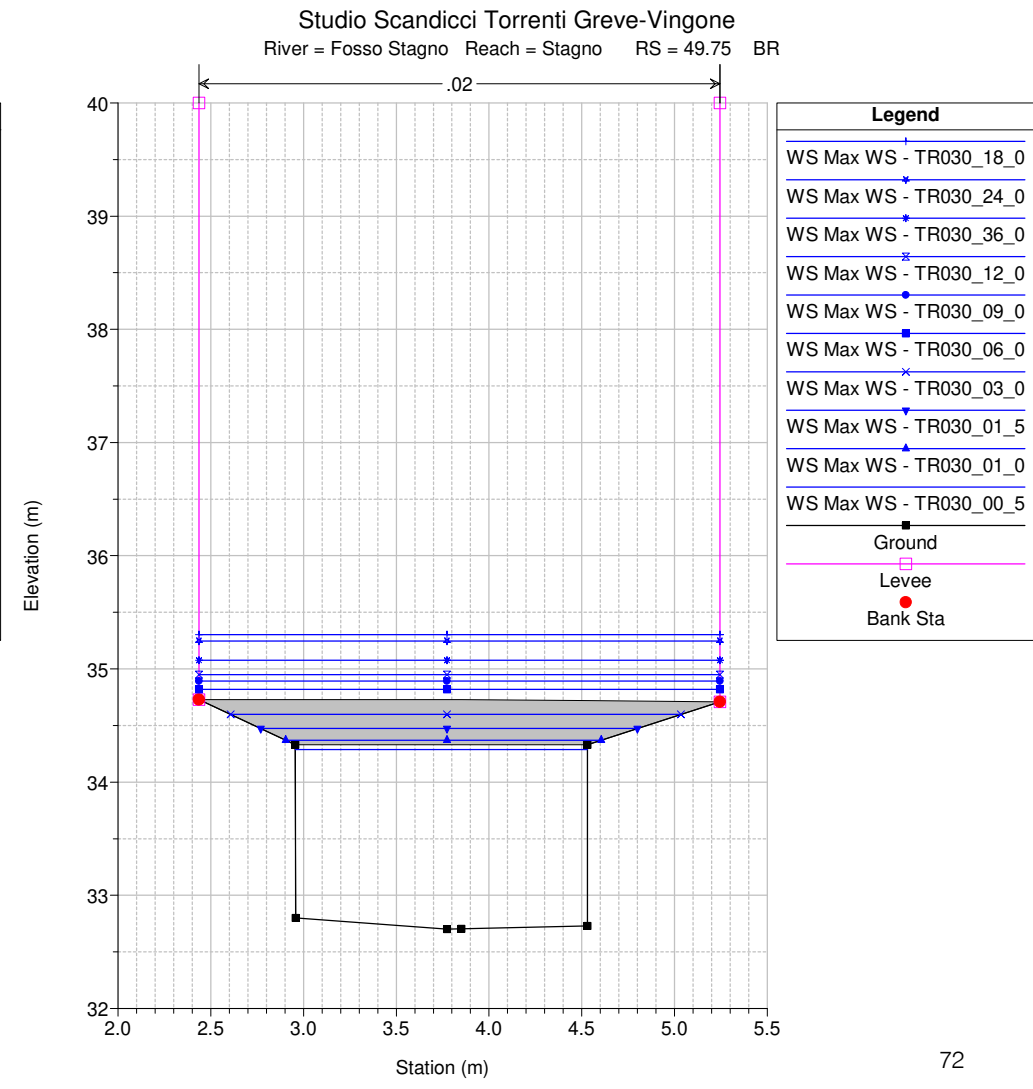
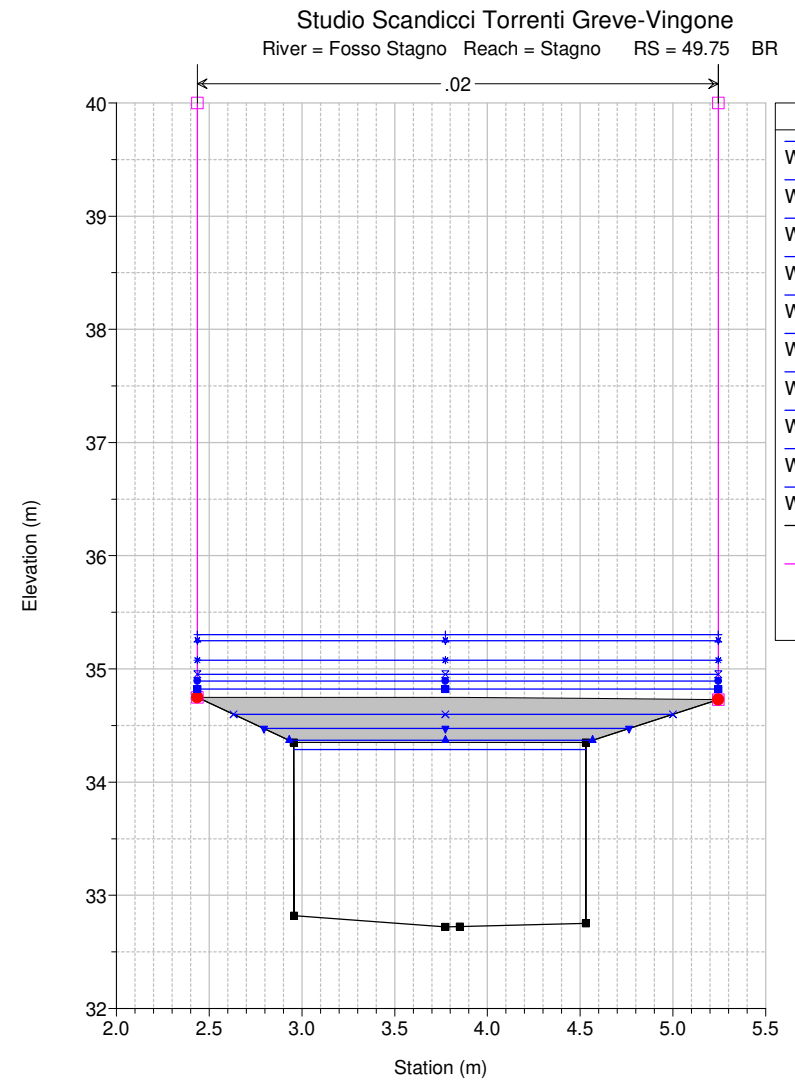
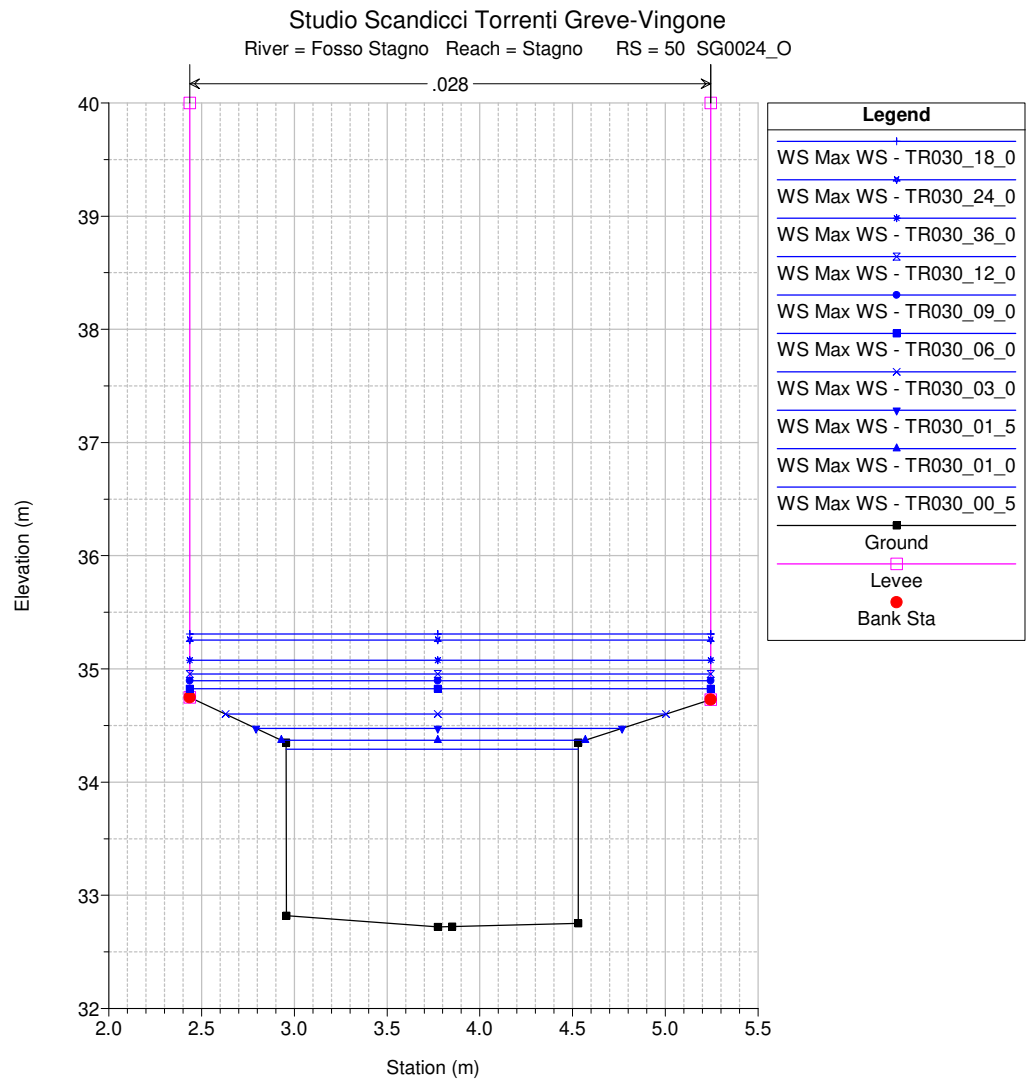
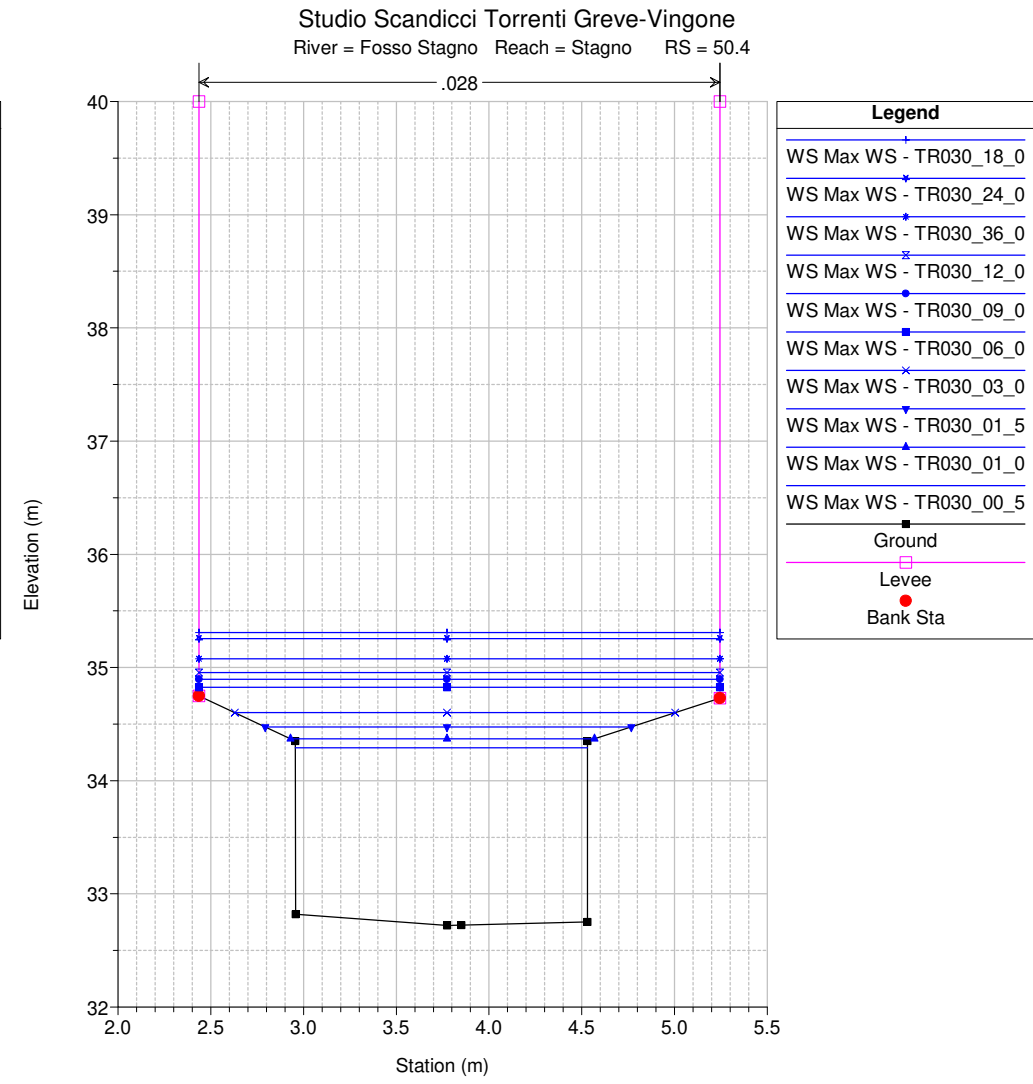
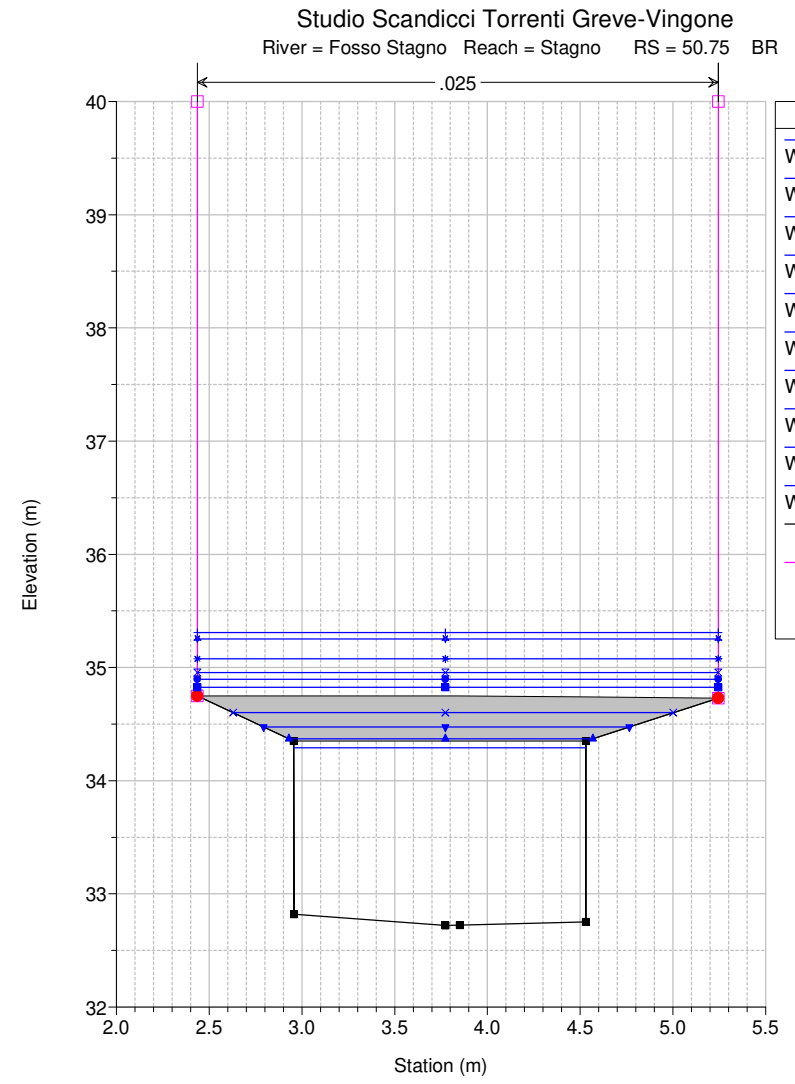
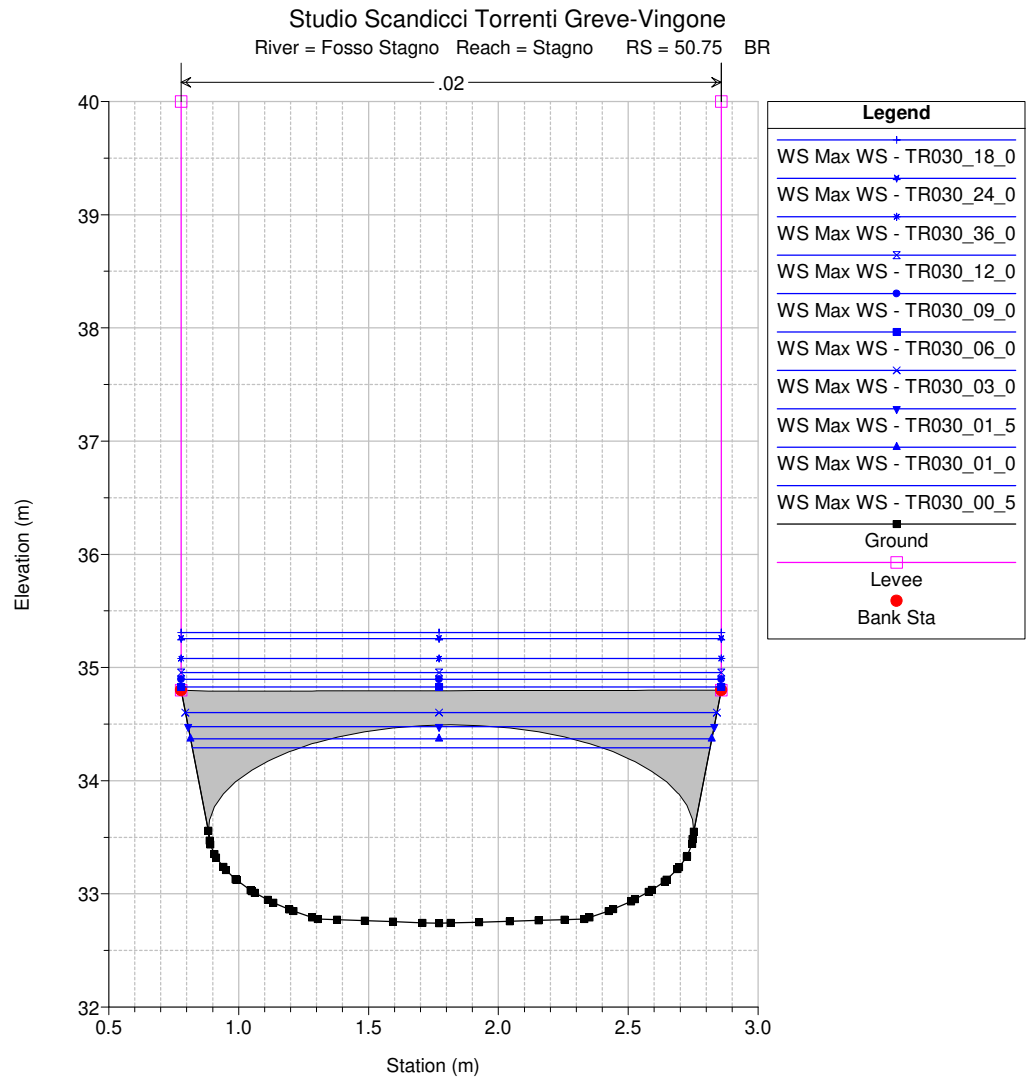

Studio Scandicci Torrenti Greve-Vingone
River = Fosso Stagno Reach = Stagno RS = 49.4

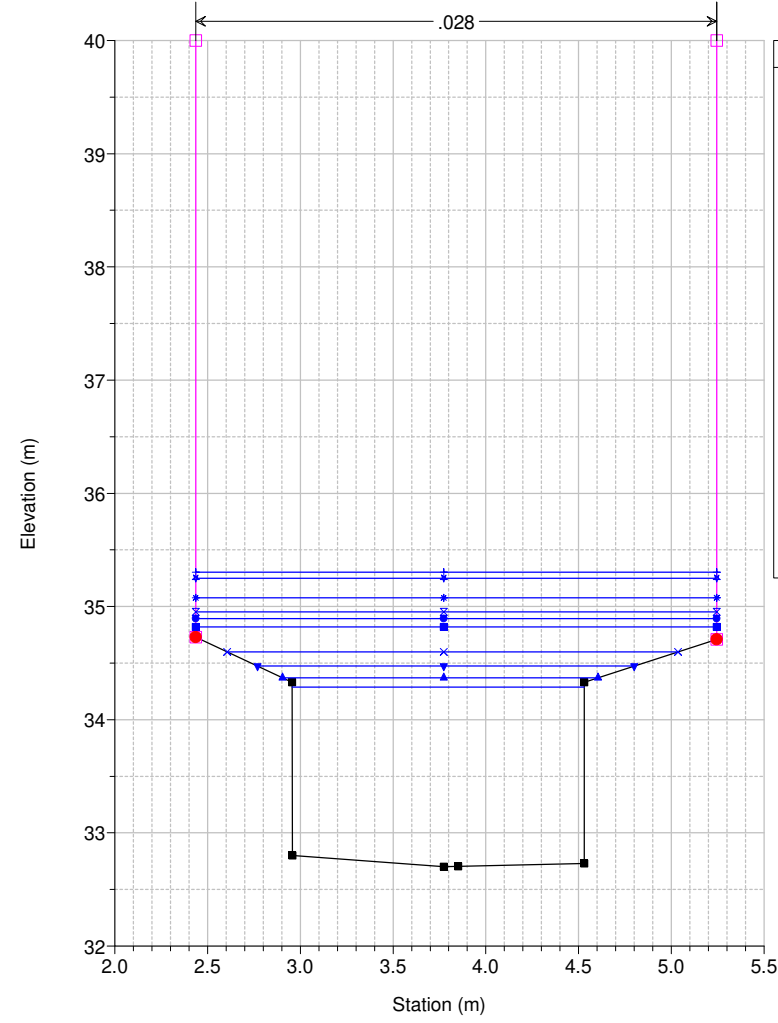

- Legend**
- WS Max WS - TR030_18_0
 - WS Max WS - TR030_24_0
 - WS Max WS - TR030_36_0
 - WS Max WS - TR030_12_0
 - WS Max WS - TR030_09_0
 - WS Max WS - TR030_06_0
 - WS Max WS - TR030_03_0
 - WS Max WS - TR030_01_5
 - WS Max WS - TR030_01_0
 - WS Max WS - TR030_00_5
 - Ground
 - Levee
 - Bank Sta

Studio Scandicci Torrenti Greve-Vingone
River = Fosso Stagno Reach = Stagno RS = 49 SG0024_P

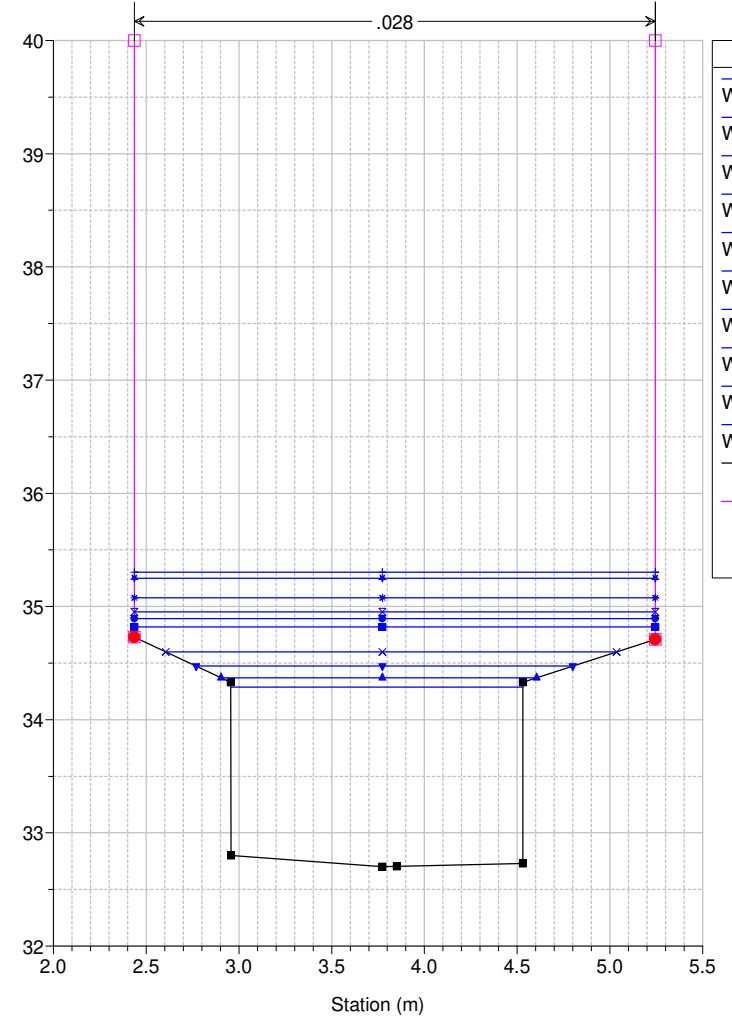

- Legend**
- WS Max WS - TR030_18_0
 - WS Max WS - TR030_24_0
 - WS Max WS - TR030_36_0
 - WS Max WS - TR030_12_0
 - WS Max WS - TR030_09_0
 - WS Max WS - TR030_06_0
 - WS Max WS - TR030_03_0
 - WS Max WS - TR030_01_5
 - WS Max WS - TR030_01_0
 - WS Max WS - TR030_00_5
 - Ground
 - Levee
 - Bank Sta

Studio Scandicci Torrenti Greve-Vingone
River = Fosso Stagno Reach = Stagno RS = 48.75 BR

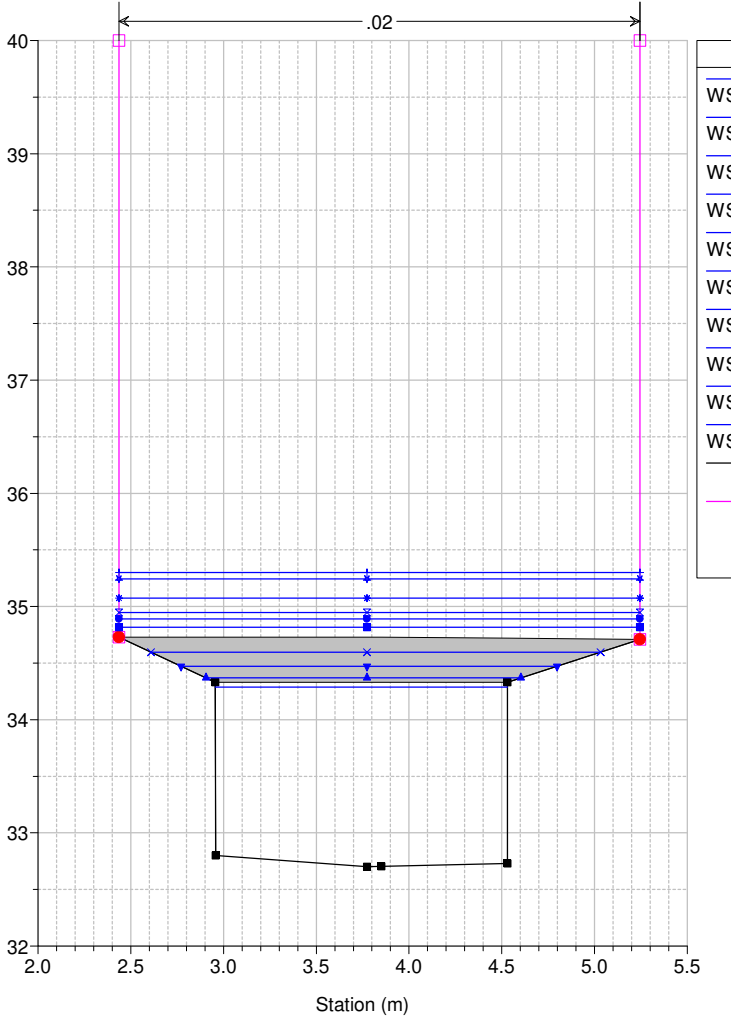

- Legend**
- WS Max WS - TR030_18_0
 - WS Max WS - TR030_24_0
 - WS Max WS - TR030_36_0
 - WS Max WS - TR030_12_0
 - WS Max WS - TR030_09_0
 - WS Max WS - TR030_06_0
 - WS Max WS - TR030_03_0
 - WS Max WS - TR030_01_5
 - WS Max WS - TR030_01_0
 - WS Max WS - TR030_00_5
 - Ground
 - Levee
 - Bank Sta

Studio Scandicci Torrenti Greve-Vingone
River = Fosso Stagno Reach = Stagno RS = 48.75 BR

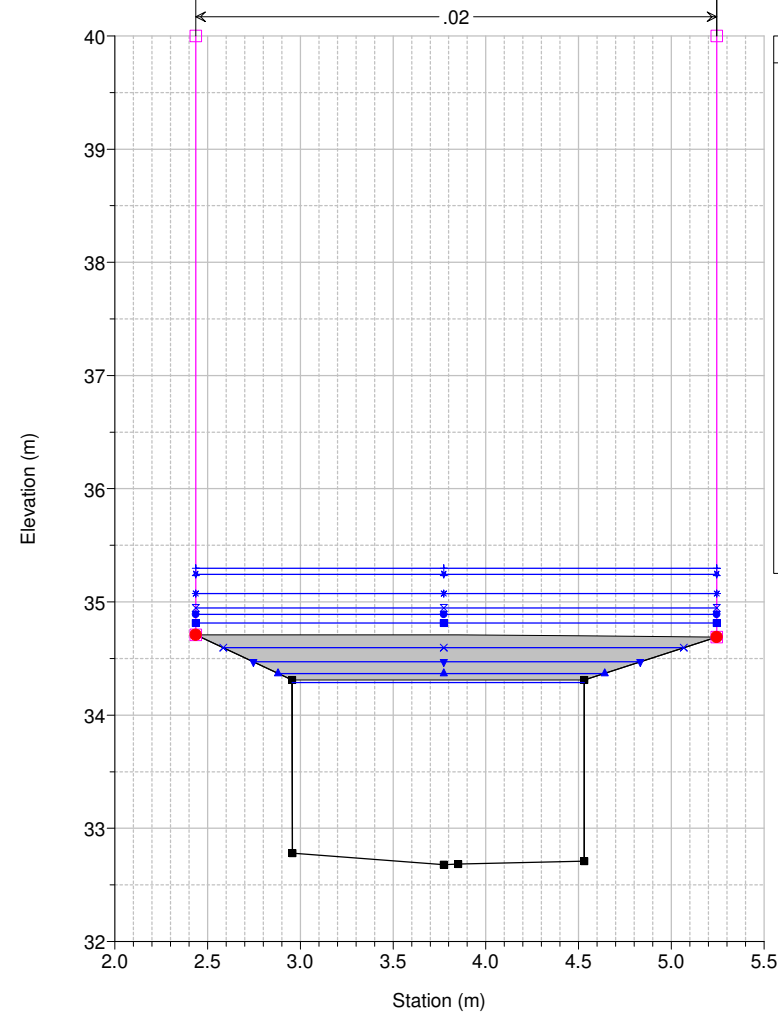

- Legend**
- WS Max WS - TR030_18_0
 - WS Max WS - TR030_24_0
 - WS Max WS - TR030_36_0
 - WS Max WS - TR030_12_0
 - WS Max WS - TR030_09_0
 - WS Max WS - TR030_06_0
 - WS Max WS - TR030_03_0
 - WS Max WS - TR030_01_5
 - WS Max WS - TR030_01_0
 - WS Max WS - TR030_00_5
 - Ground
 - Levee
 - Bank Sta

Studio Scandicci Torrenti Greve-Vingone
River = Fosso Stagno Reach = Stagno RS = 48.7

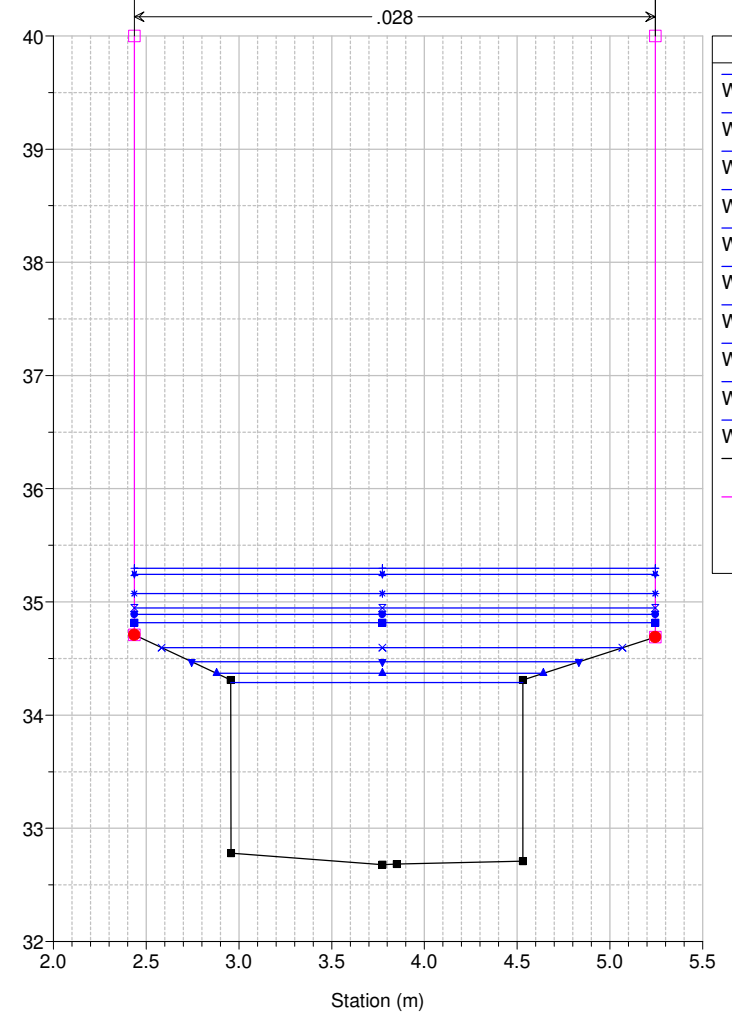

- Legend**
- WS Max WS - TR030_18_0
 - WS Max WS - TR030_24_0
 - WS Max WS - TR030_36_0
 - WS Max WS - TR030_12_0
 - WS Max WS - TR030_09_0
 - WS Max WS - TR030_06_0
 - WS Max WS - TR030_03_0
 - WS Max WS - TR030_01_5
 - WS Max WS - TR030_01_0
 - WS Max WS - TR030_00_5
 - Ground
 - Levee
 - Bank Sta

Studio Scandicci Torrenti Greve-Vingone
River = Fosso Stagno Reach = Stagno RS = 48 SG0024_Q

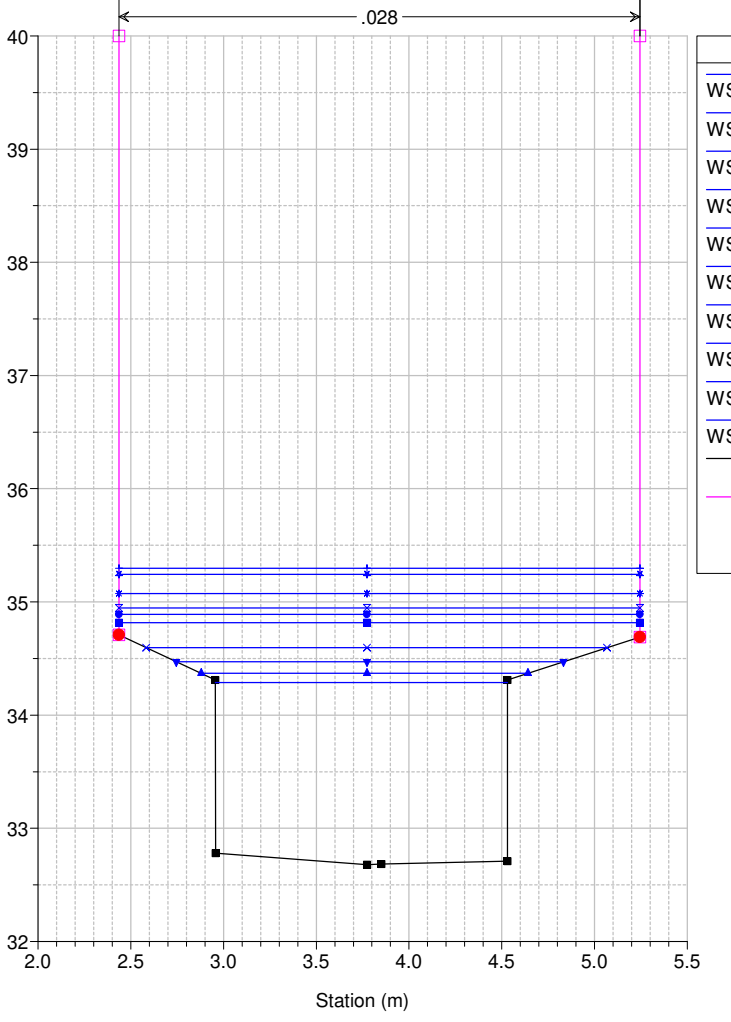

- Legend**
- WS Max WS - TR030_18_0
 - WS Max WS - TR030_24_0
 - WS Max WS - TR030_36_0
 - WS Max WS - TR030_12_0
 - WS Max WS - TR030_09_0
 - WS Max WS - TR030_06_0
 - WS Max WS - TR030_03_0
 - WS Max WS - TR030_01_5
 - WS Max WS - TR030_01_0
 - WS Max WS - TR030_00_5
 - Ground
 - Levee
 - Bank Sta

Studio Scandicci Torrenti Greve-Vingone
River = Fosso Stagno Reach = Stagno RS = 47.75 BR

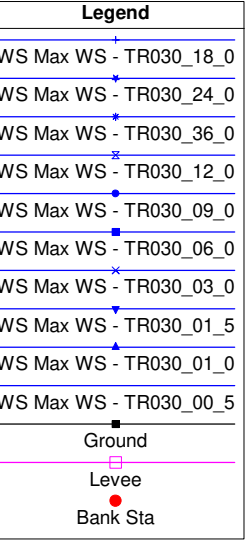
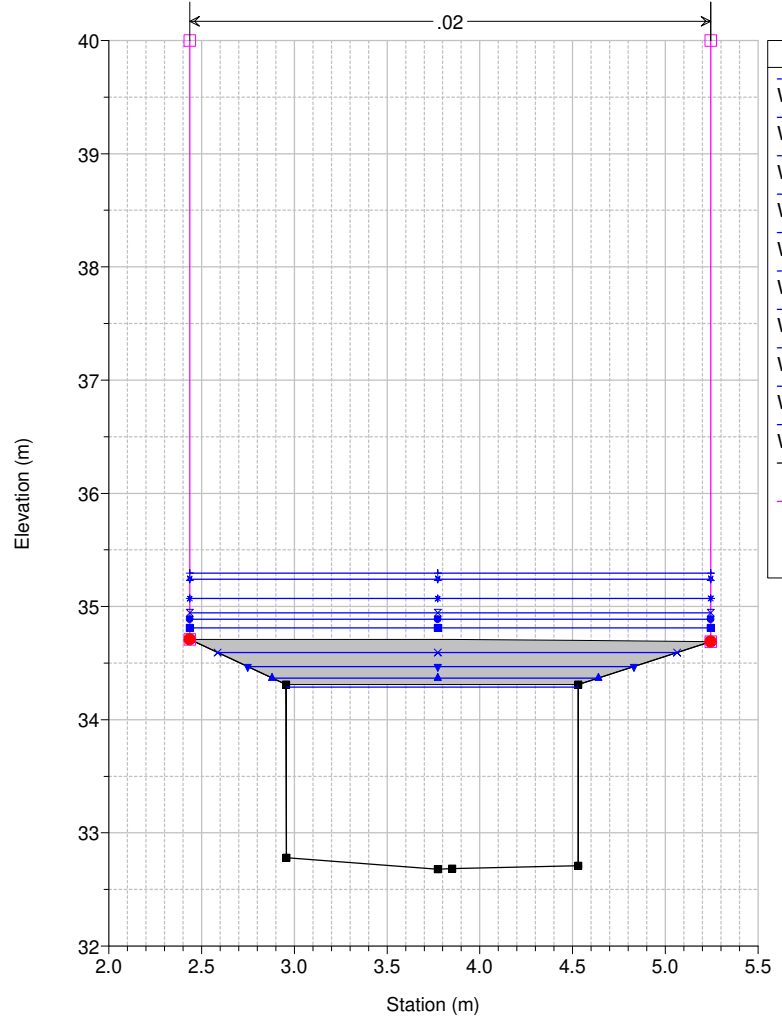

Studio Scandicci Torrenti Greve-Vingone
River = Fosso Stagno Reach = Stagno RS = 47.75 BR

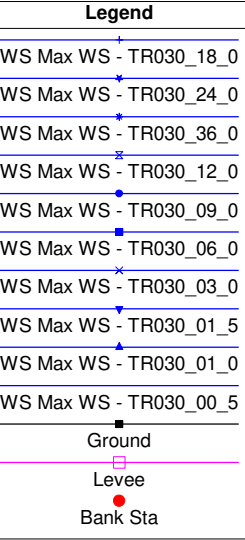
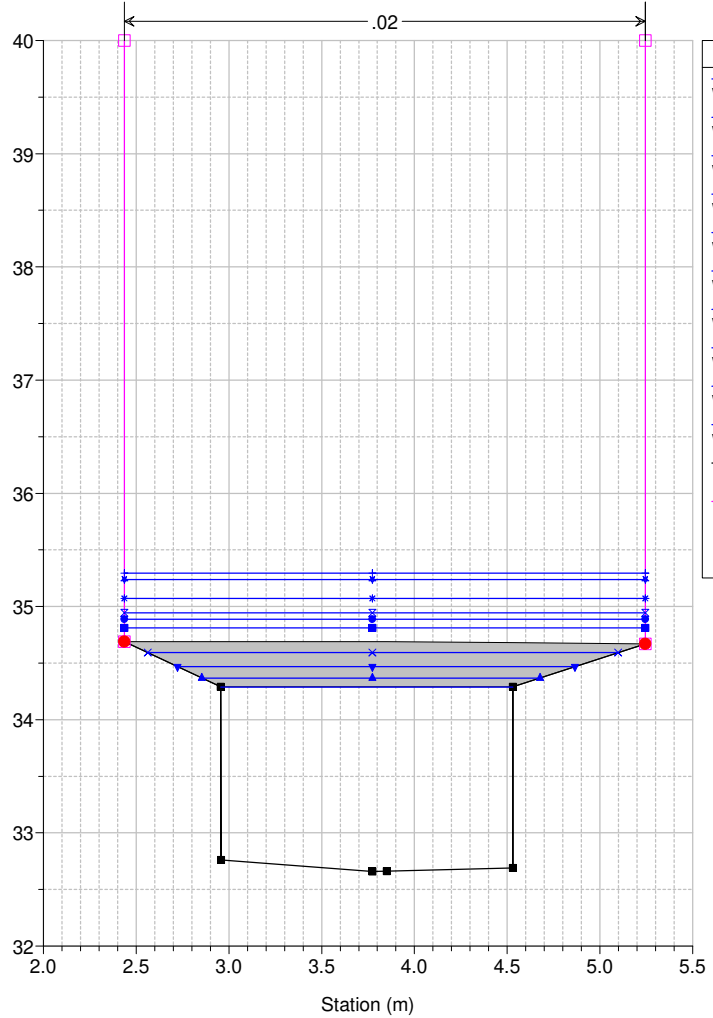

Studio Scandicci Torrenti Greve-Vingone
River = Fosso Stagno Reach = Stagno RS = 47.4

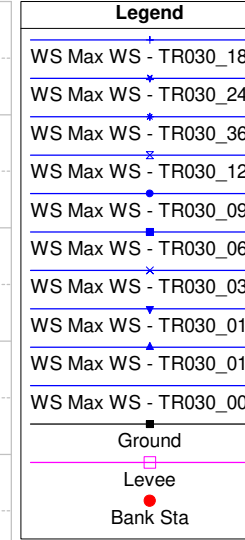
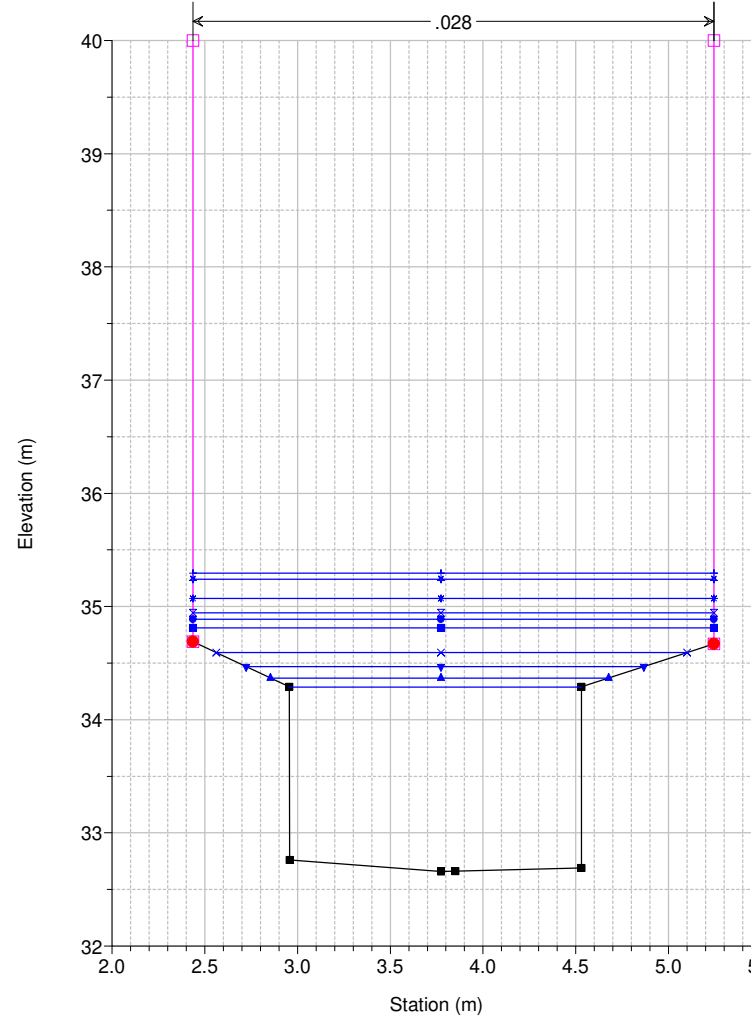

Studio Scandicci Torrenti Greve-Vingone
River = Fosso Stagno Reach = Stagno RS = 47 SG0024_R

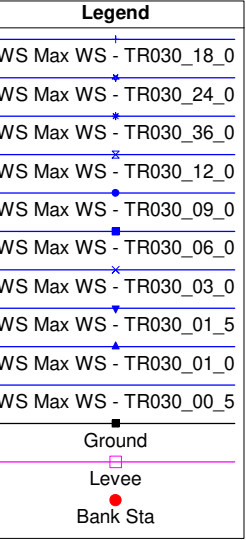
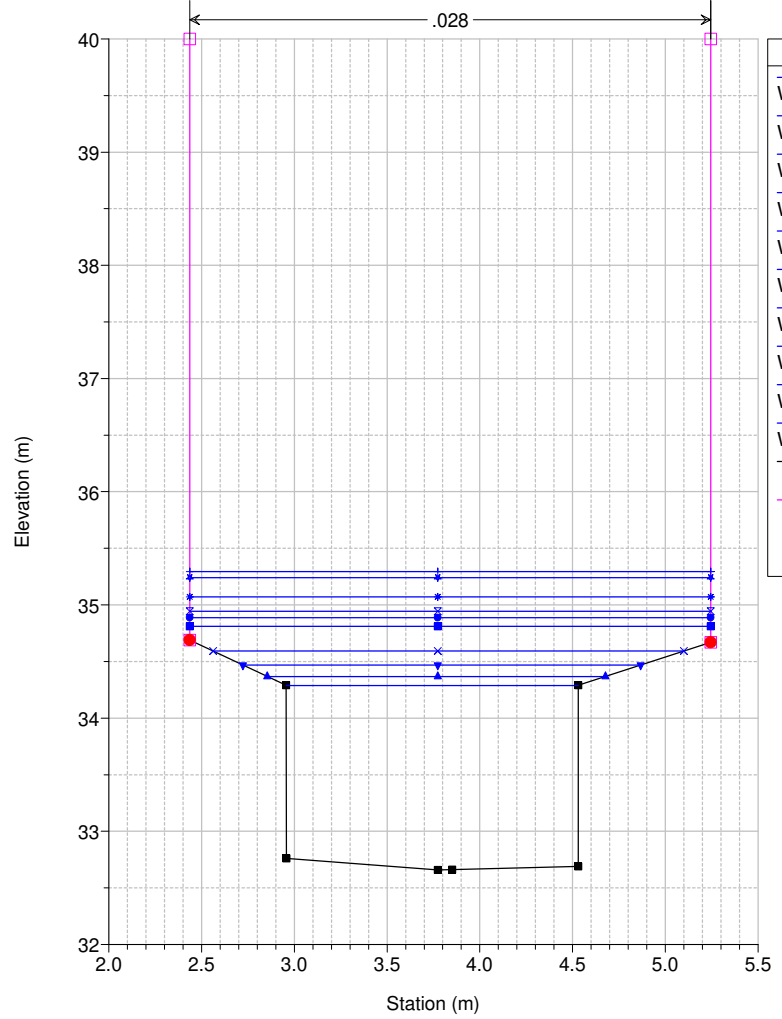

Studio Scandicci Torrenti Greve-Vingone
River = Fosso Stagno Reach = Stagno RS = 46.75 BR

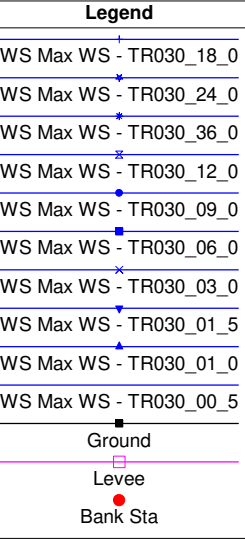
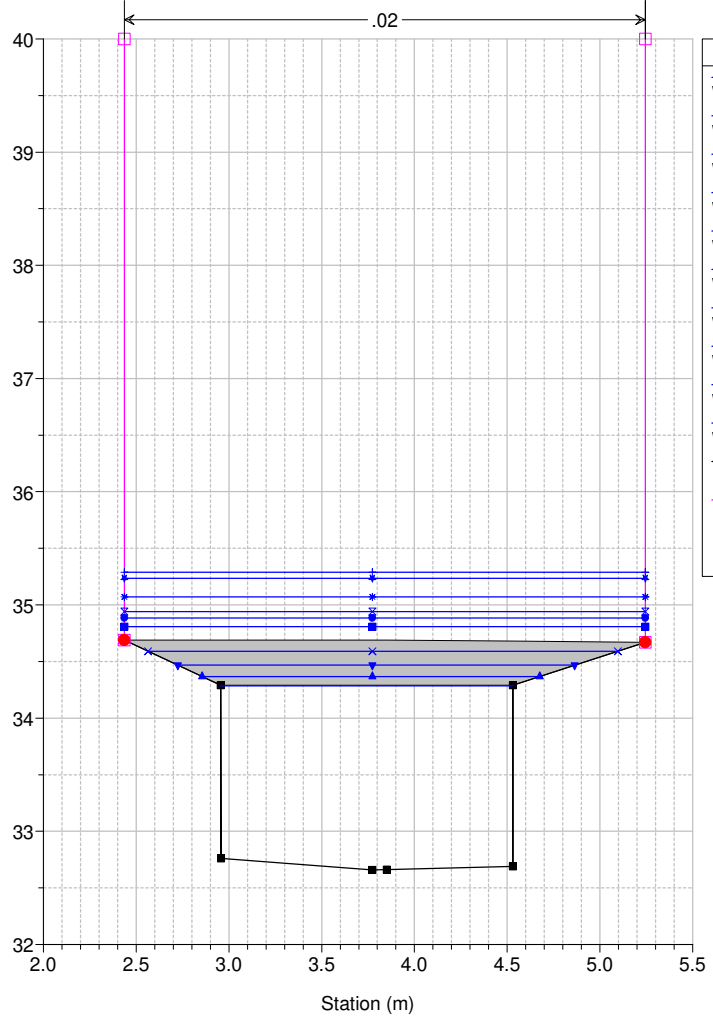

Studio Scandicci Torrenti Greve-Vingone
River = Fosso Stagno Reach = Stagno RS = 46.75 BR

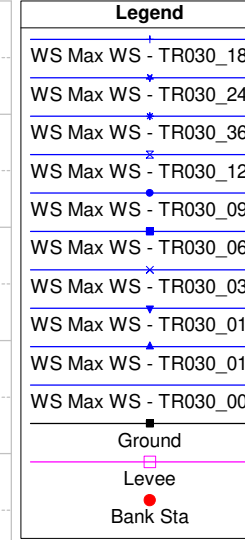
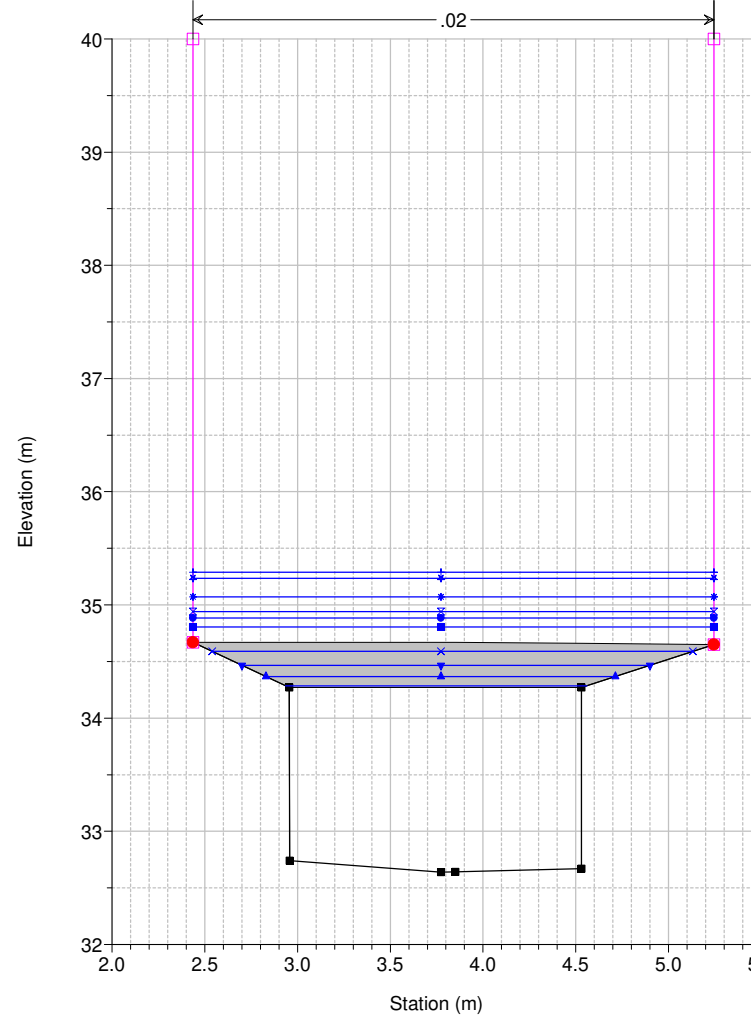

Studio Scandicci Torrenti Greve-Vingone
 River = Fosso Stagno Reach = Stagno RS = 46.4

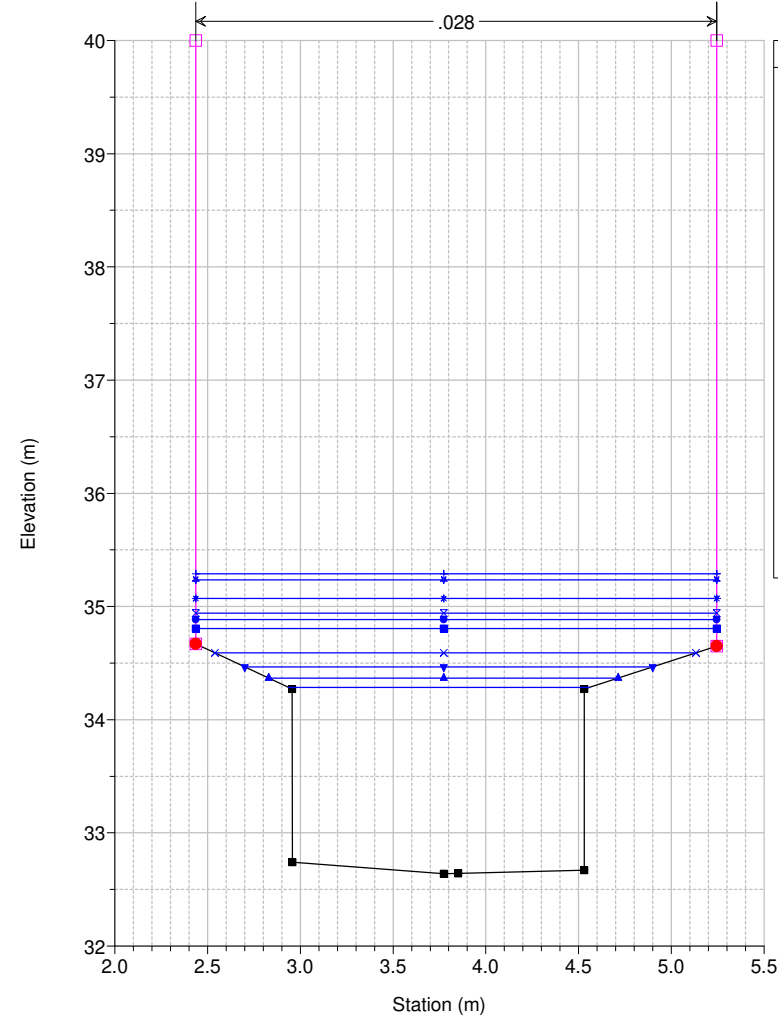

Legend

- WS Max WS - TR030_18_0
- WS Max WS - TR030_24_0
- WS Max WS - TR030_36_0
- WS Max WS - TR030_12_0
- WS Max WS - TR030_09_0
- WS Max WS - TR030_06_0
- WS Max WS - TR030_03_0
- WS Max WS - TR030_01_5
- WS Max WS - TR030_01_0
- WS Max WS - TR030_00_5
- Ground
- Levee
- Bank Sta

Studio Scandicci Torrenti Greve-Vingone
 River = Fosso Stagno Reach = Stagno RS = 46 SG0024_S

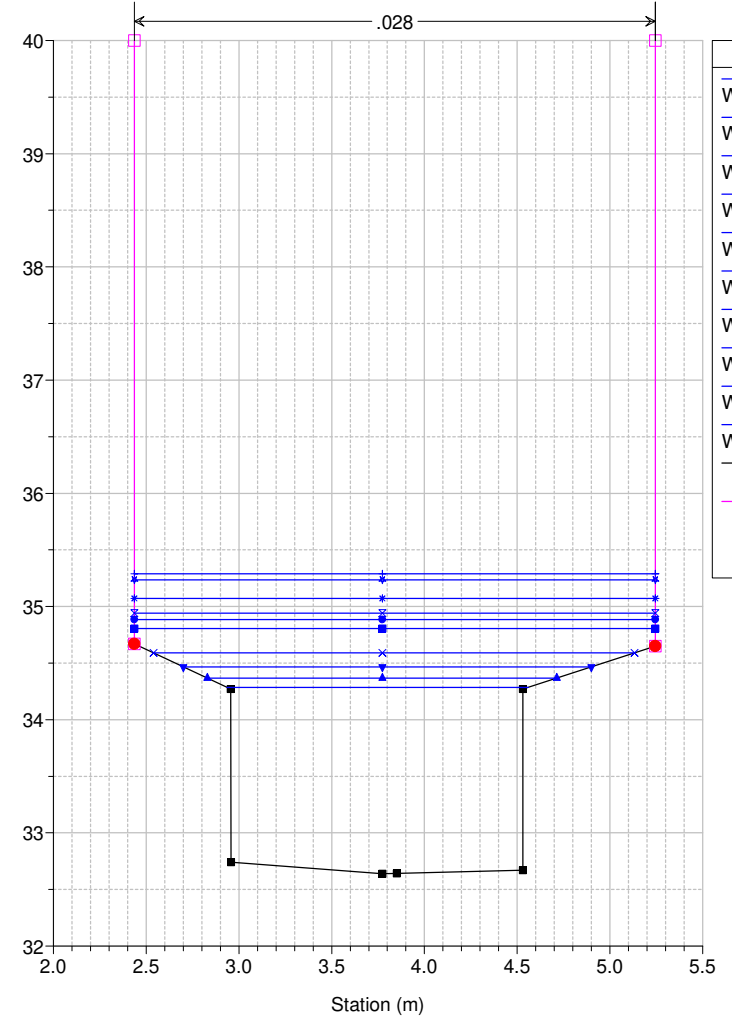

Legend

- WS Max WS - TR030_18_0
- WS Max WS - TR030_24_0
- WS Max WS - TR030_36_0
- WS Max WS - TR030_12_0
- WS Max WS - TR030_09_0
- WS Max WS - TR030_06_0
- WS Max WS - TR030_03_0
- WS Max WS - TR030_01_5
- WS Max WS - TR030_01_0
- WS Max WS - TR030_00_5
- Ground
- Levee
- Bank Sta

Studio Scandicci Torrenti Greve-Vingone
 River = Fosso Stagno Reach = Stagno RS = 45.75 BR

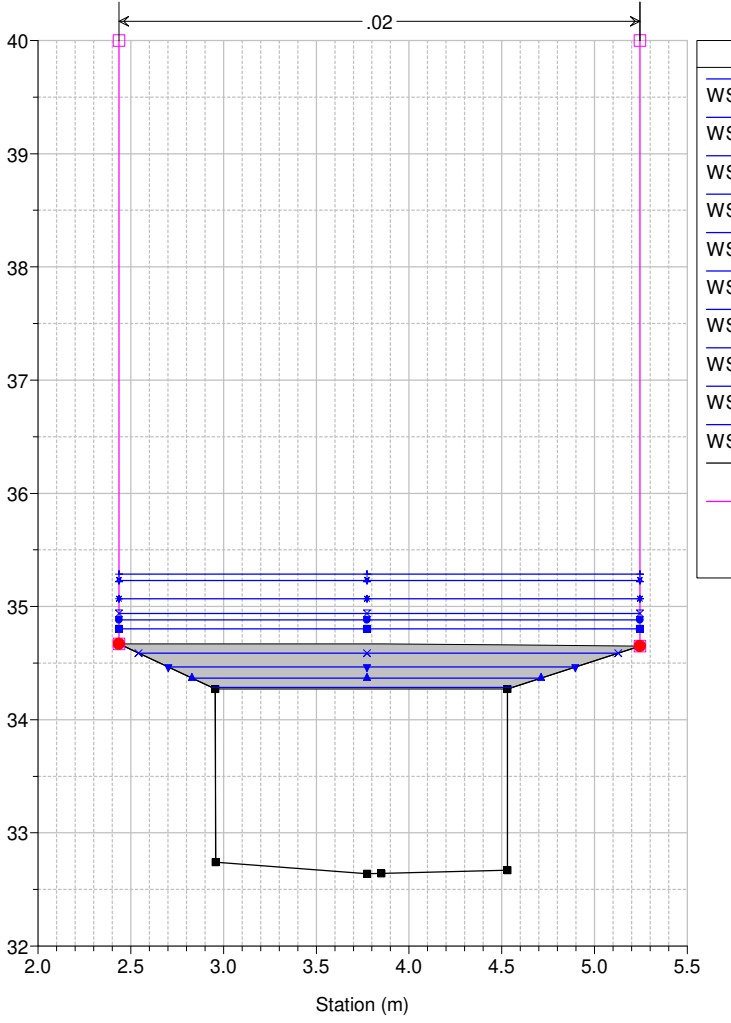

Legend

- WS Max WS - TR030_18_0
- WS Max WS - TR030_24_0
- WS Max WS - TR030_36_0
- WS Max WS - TR030_12_0
- WS Max WS - TR030_09_0
- WS Max WS - TR030_06_0
- WS Max WS - TR030_03_0
- WS Max WS - TR030_01_5
- WS Max WS - TR030_01_0
- WS Max WS - TR030_00_5
- Ground
- Levee
- Bank Sta

Studio Scandicci Torrenti Greve-Vingone
 River = Fosso Stagno Reach = Stagno RS = 45.75 BR

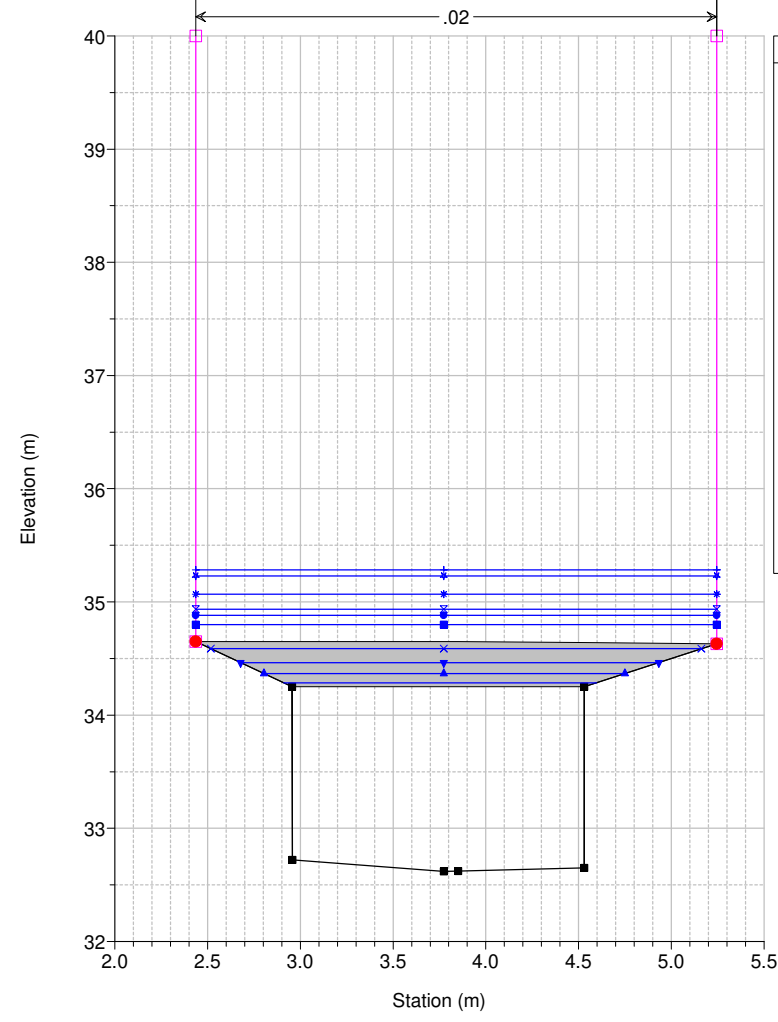

Legend

- WS Max WS - TR030_18_0
- WS Max WS - TR030_24_0
- WS Max WS - TR030_36_0
- WS Max WS - TR030_12_0
- WS Max WS - TR030_09_0
- WS Max WS - TR030_06_0
- WS Max WS - TR030_03_0
- WS Max WS - TR030_01_5
- WS Max WS - TR030_01_0
- WS Max WS - TR030_00_5
- Ground
- Levee
- Bank Sta

Studio Scandicci Torrenti Greve-Vingone
 River = Fosso Stagno Reach = Stagno RS = 45.4

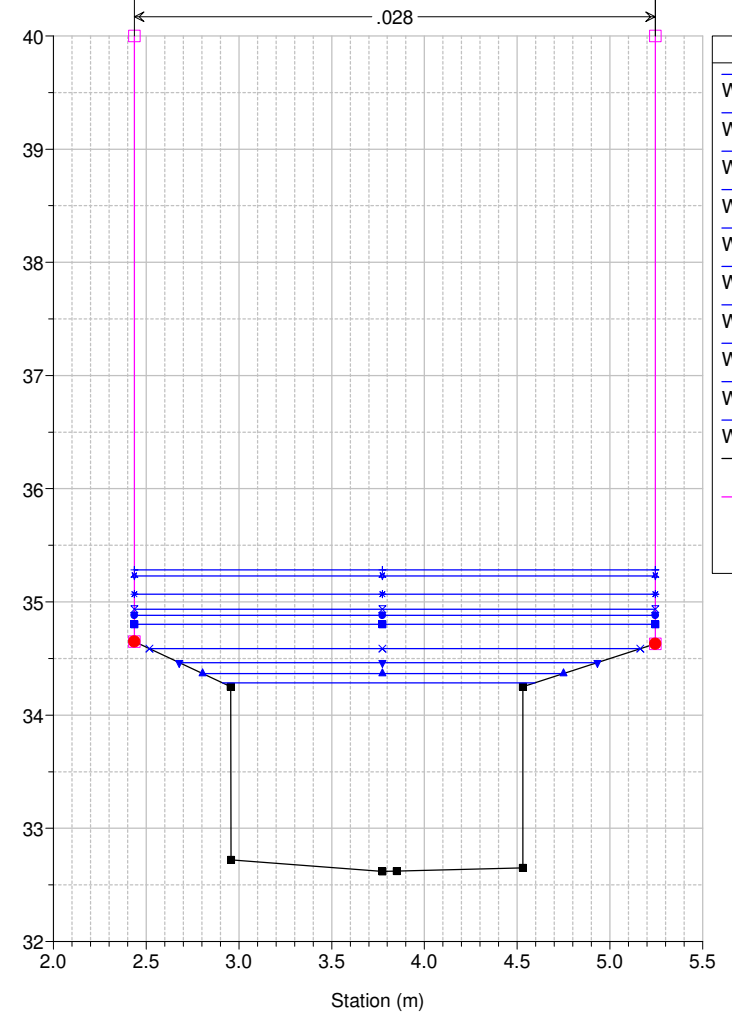

Legend

- WS Max WS - TR030_18_0
- WS Max WS - TR030_24_0
- WS Max WS - TR030_36_0
- WS Max WS - TR030_12_0
- WS Max WS - TR030_09_0
- WS Max WS - TR030_06_0
- WS Max WS - TR030_03_0
- WS Max WS - TR030_01_5
- WS Max WS - TR030_01_0
- WS Max WS - TR030_00_5
- Ground
- Levee
- Bank Sta

Studio Scandicci Torrenti Greve-Vingone
 River = Fosso Stagno Reach = Stagno RS = 45 SG0024_T

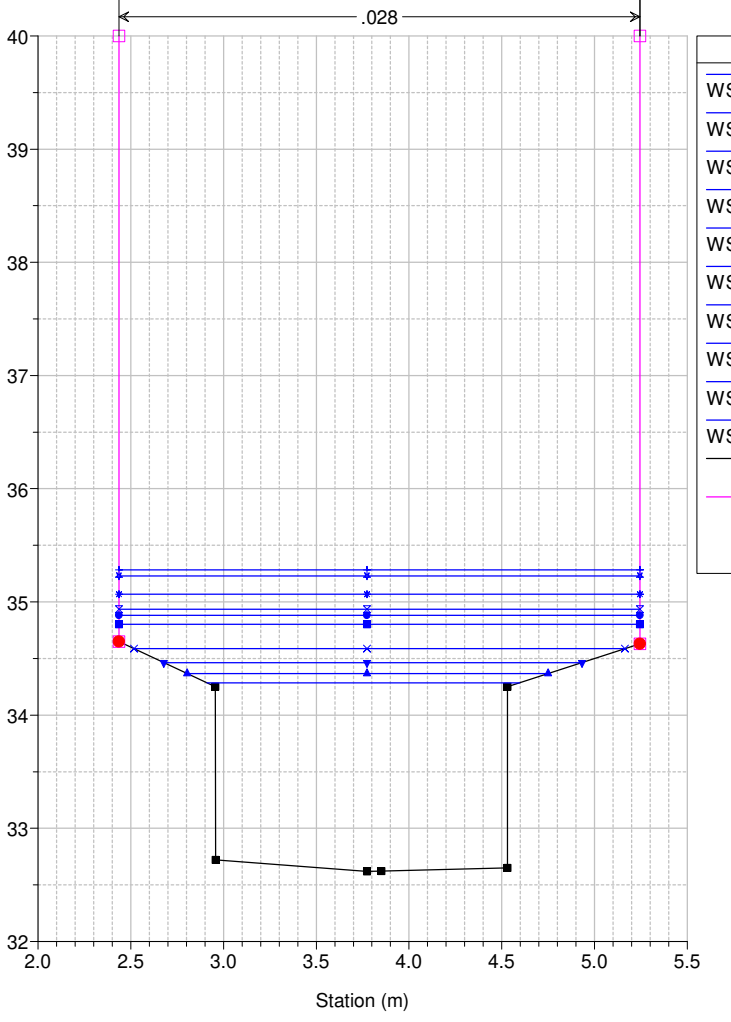

Legend

- WS Max WS - TR030_18_0
- WS Max WS - TR030_24_0
- WS Max WS - TR030_36_0
- WS Max WS - TR030_12_0
- WS Max WS - TR030_09_0
- WS Max WS - TR030_06_0
- WS Max WS - TR030_03_0
- WS Max WS - TR030_01_5
- WS Max WS - TR030_01_0
- WS Max WS - TR030_00_5
- Ground
- Levee
- Bank Sta

Studio Scandicci Torrenti Greve-Vingone
River = Fosso Stagno Reach = Stagno RS = 44.75 BR

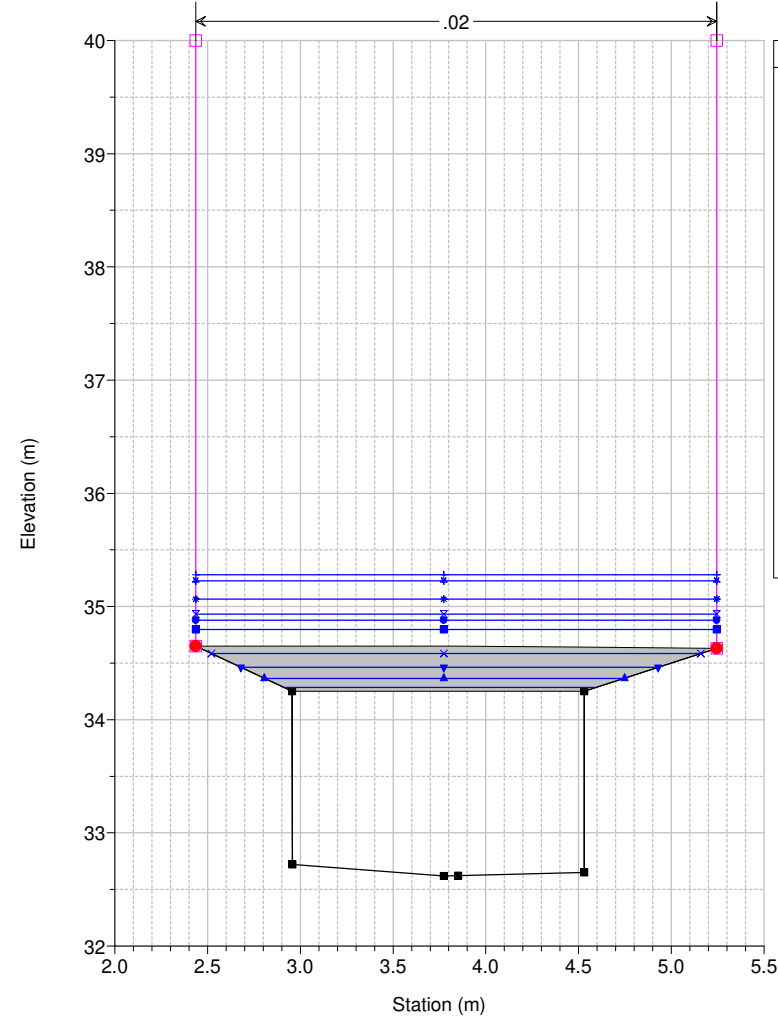

Studio Scandicci Torrenti Greve-Vingone
River = Fosso Stagno Reach = Stagno RS = 44.75 BR

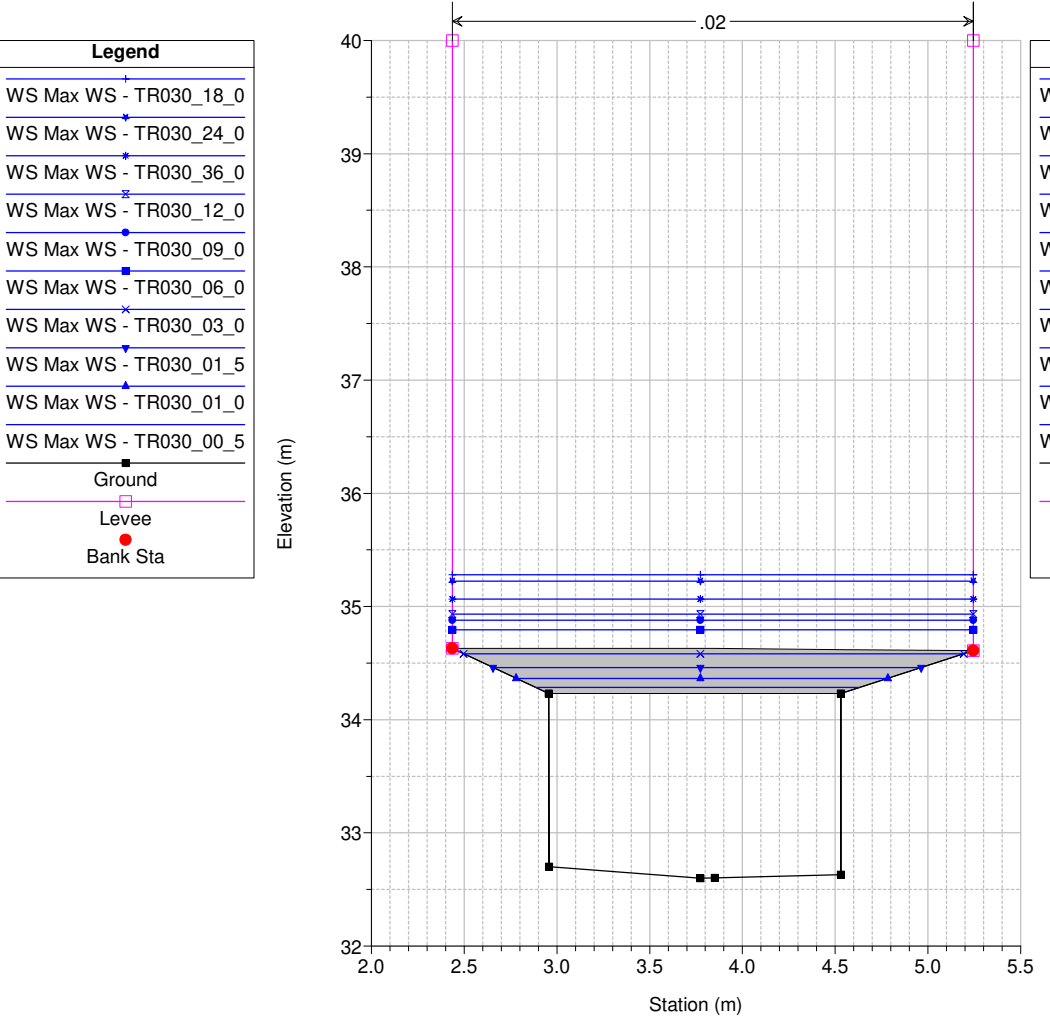

Studio Scandicci Torrenti Greve-Vingone
River = Fosso Stagno Reach = Stagno RS = 44 SG0024_C

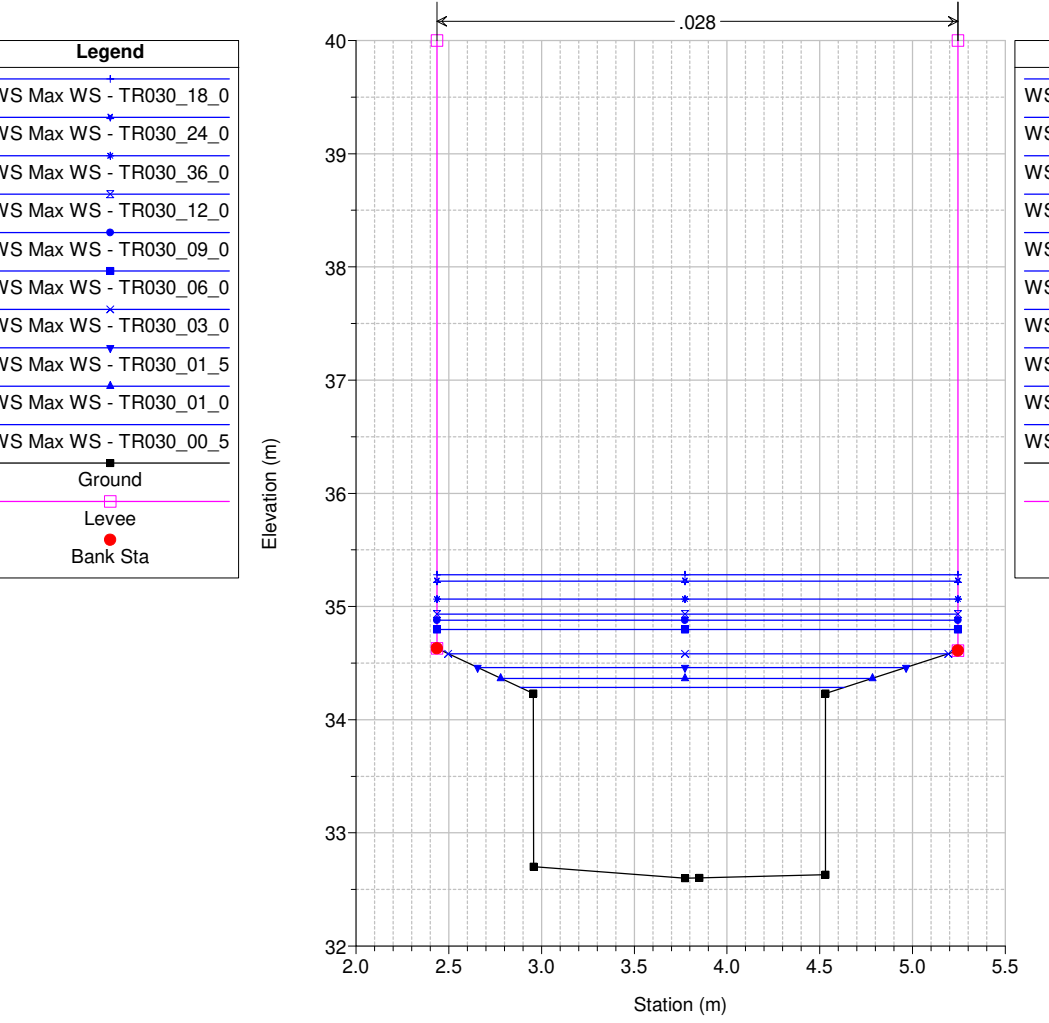

Studio Scandicci Torrenti Greve-Vingone
River = Fosso Stagno Reach = Stagno RS = 43 SG0024_D

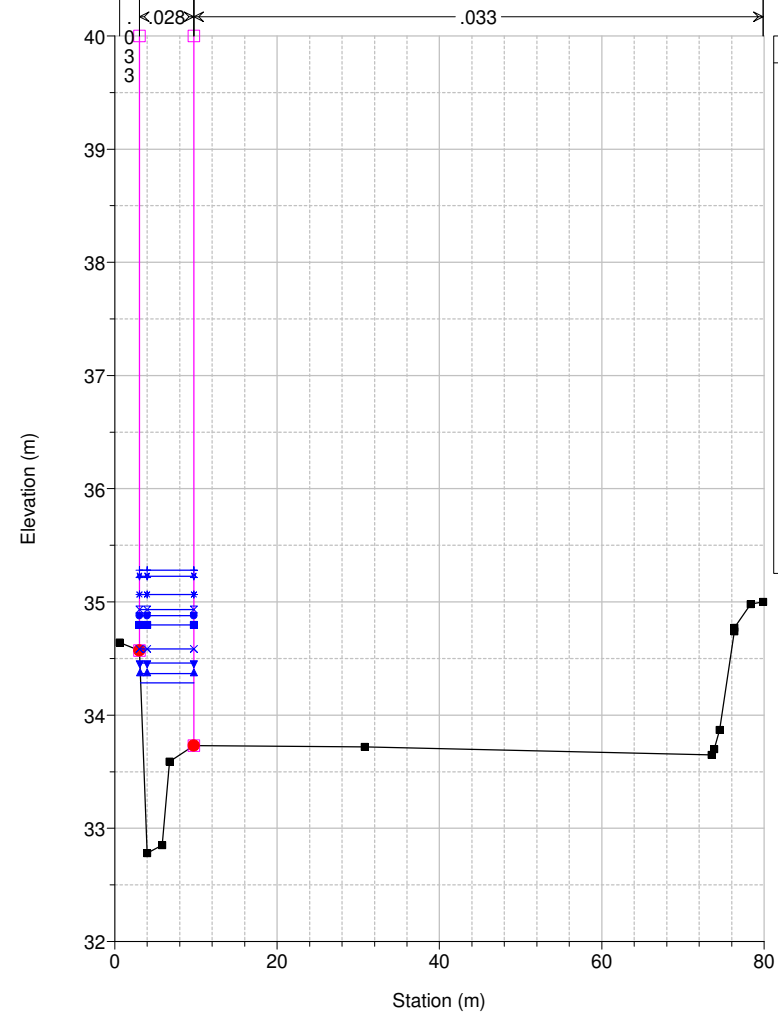

Studio Scandicci Torrenti Greve-Vingone
River = Fosso Stagno Reach = Stagno RS = 42 SG0025_

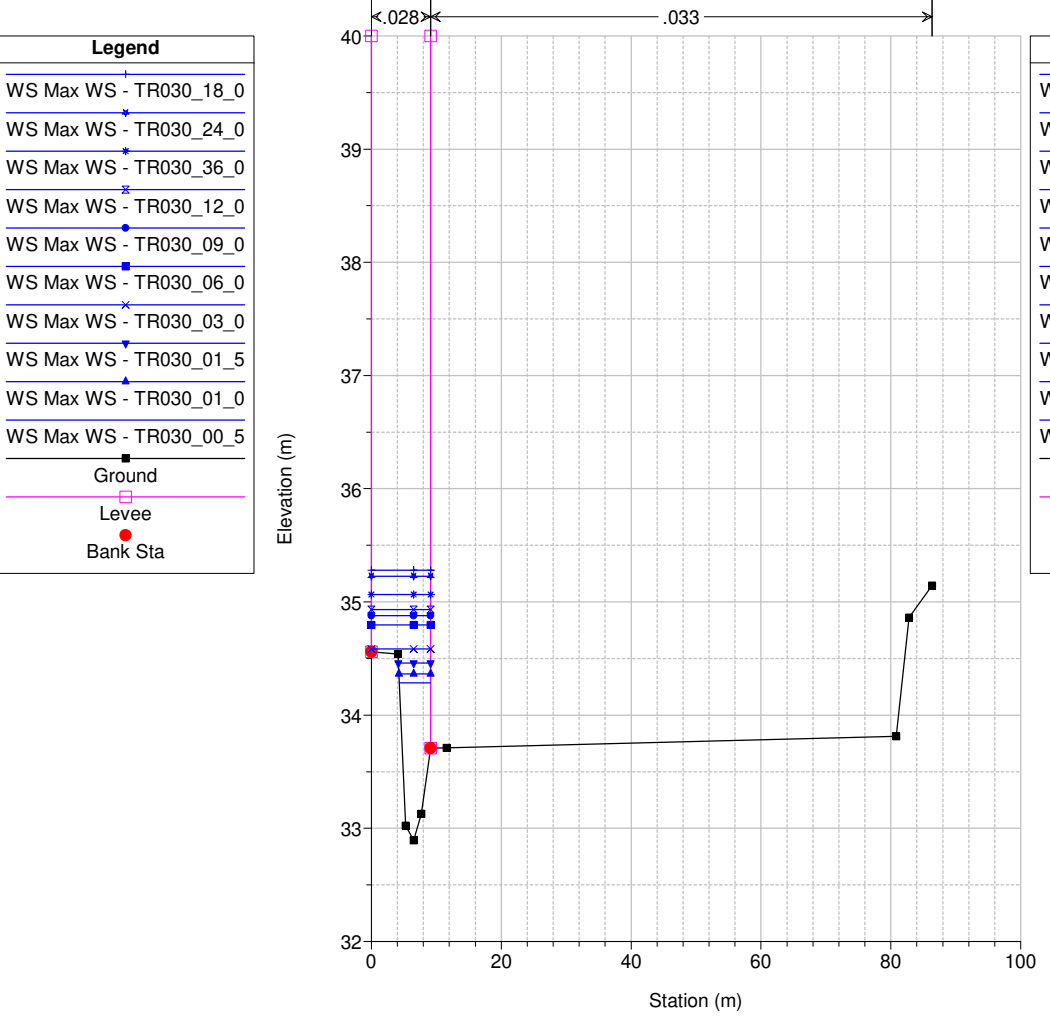

Studio Scandicci Torrenti Greve-Vingone
River = Fosso Stagno Reach = Stagno RS = 41 SG0026_

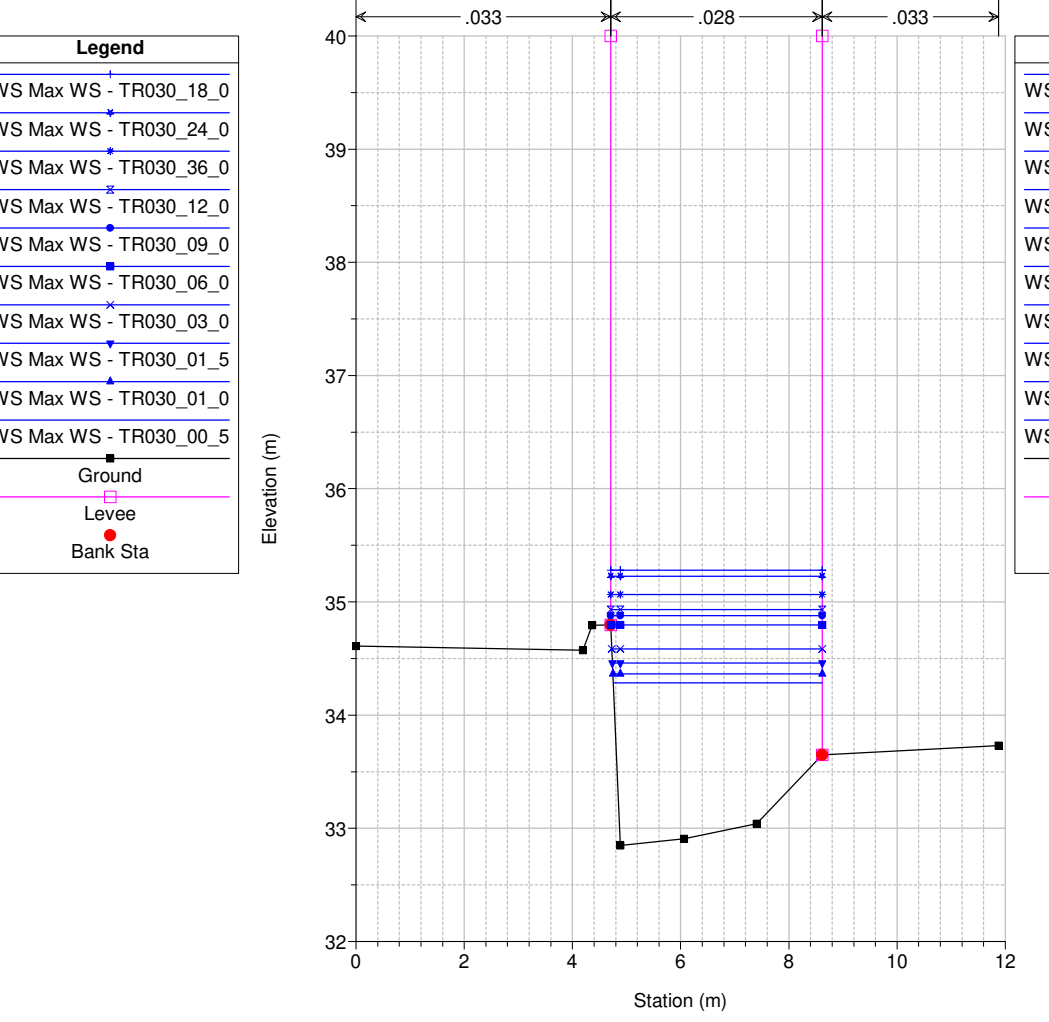

Studio Scandicci Torrenti Greve-Vingone
River = Fosso Stagno Reach = Stagno RS = 40 SG0027__

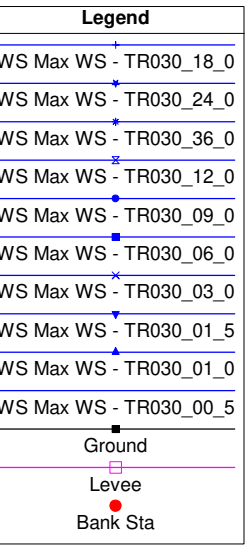
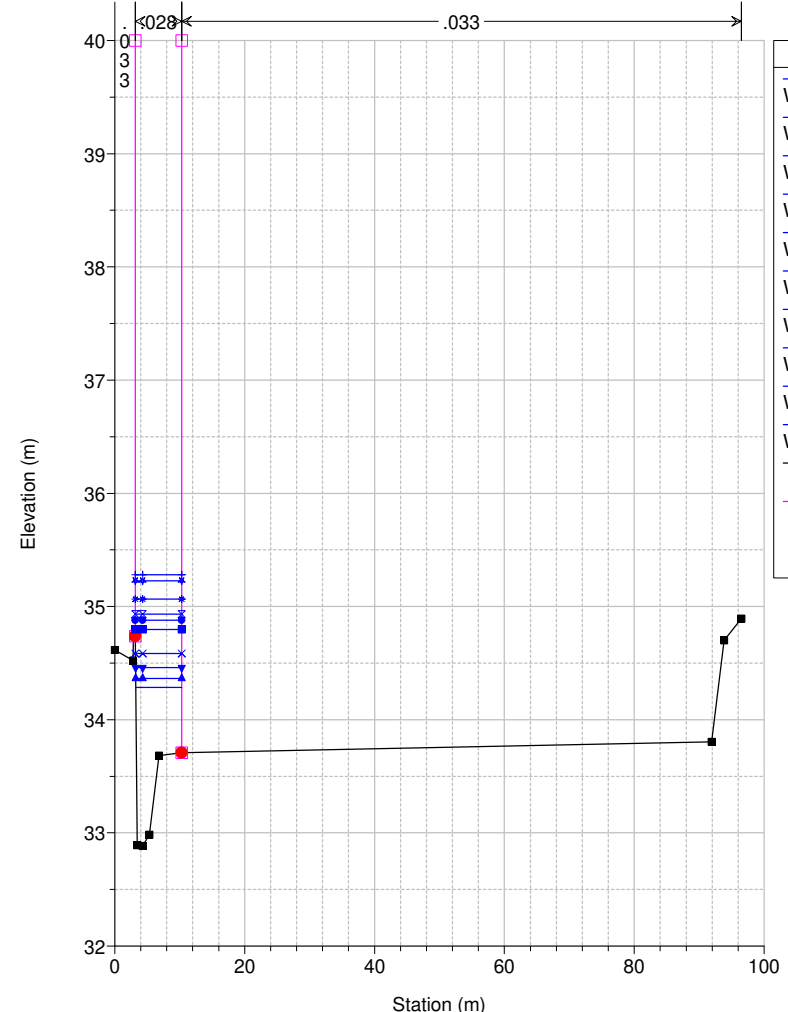

Studio Scandicci Torrenti Greve-Vingone
River = Fosso Stagno Reach = Stagno RS = 39 SG0028__

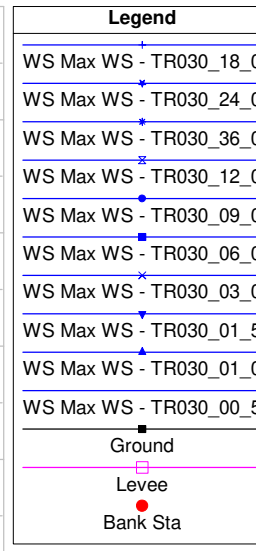
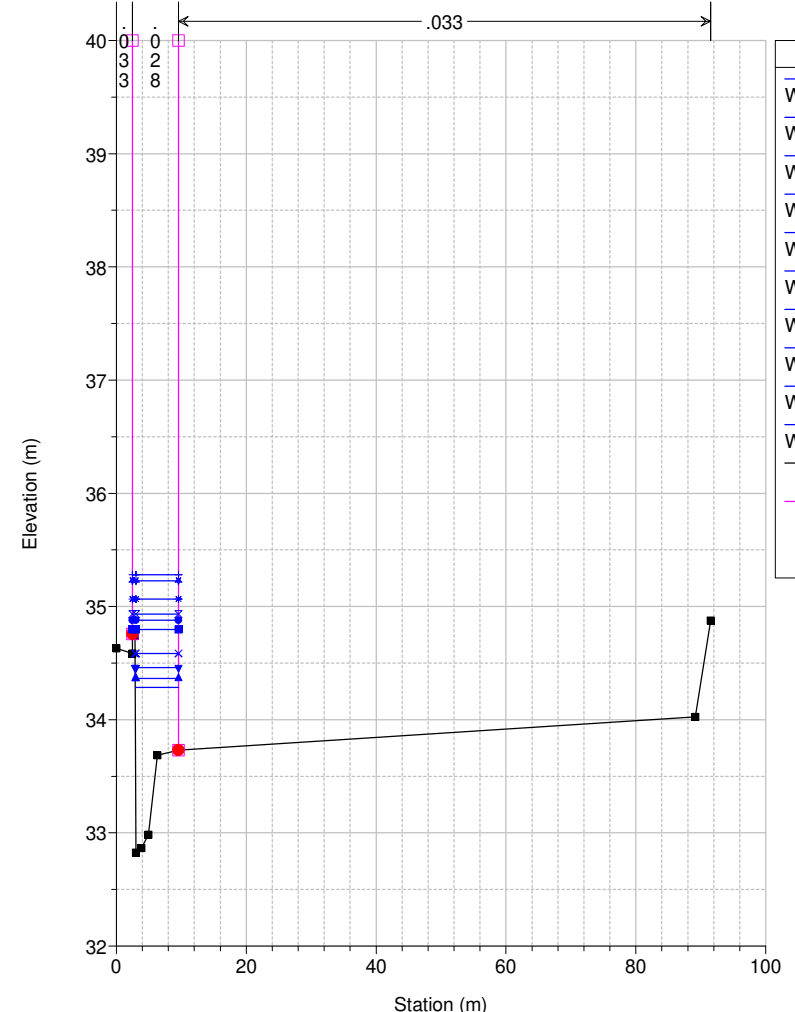

Studio Scandicci Torrenti Greve-Vingone
River = Fosso Stagno Reach = Stagno RS = 38 SG0029__

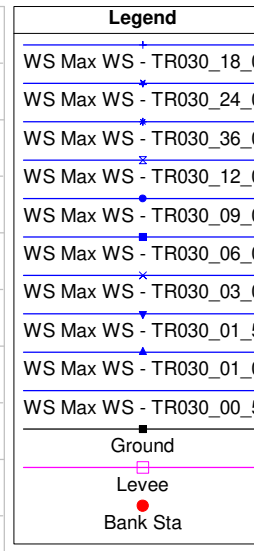
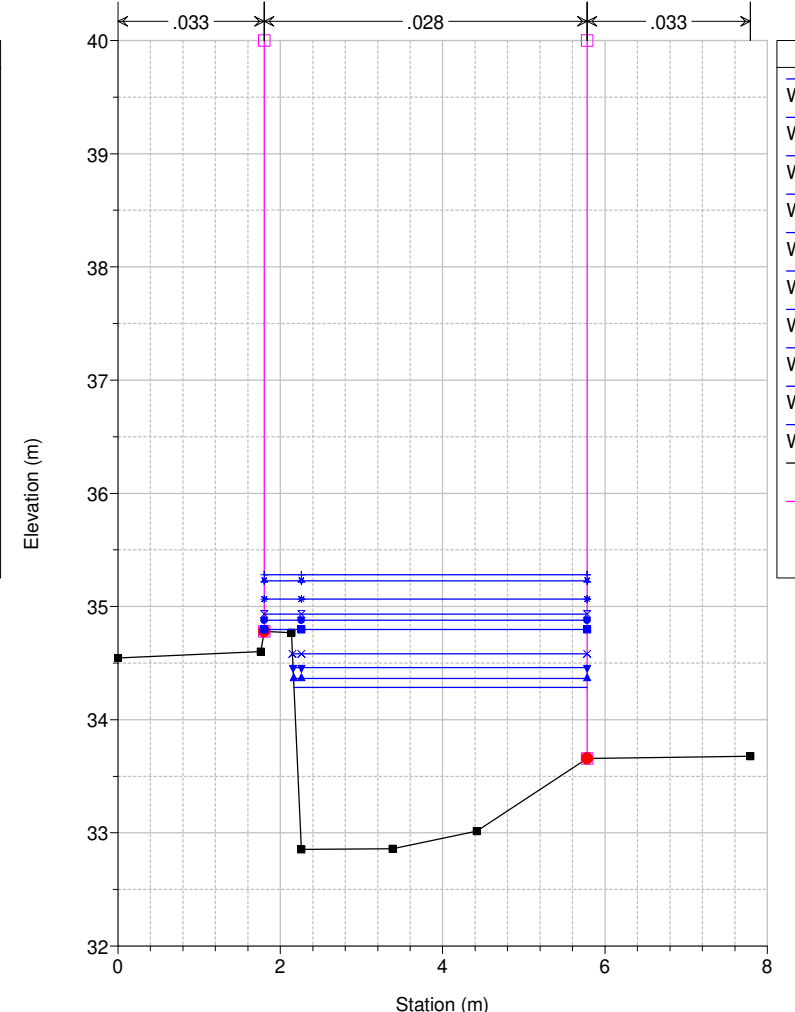

Studio Scandicci Torrenti Greve-Vingone
River = Fosso Stagno Reach = Stagno RS = 37 SG0030__

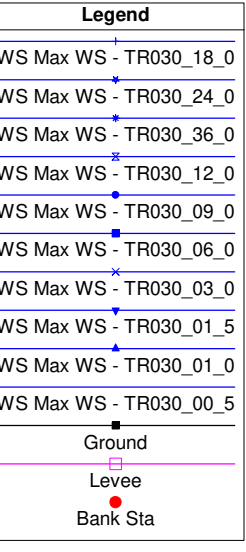
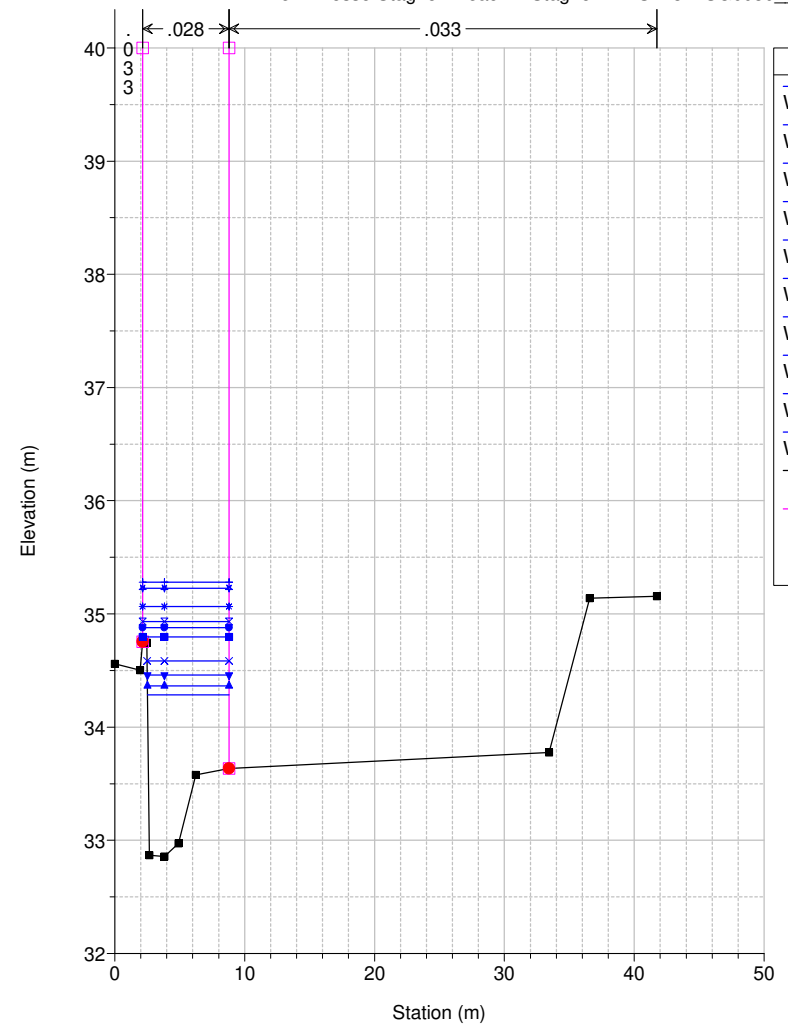

Studio Scandicci Torrenti Greve-Vingone
River = Fosso Stagno Reach = Stagno RS = 36 SG0031__

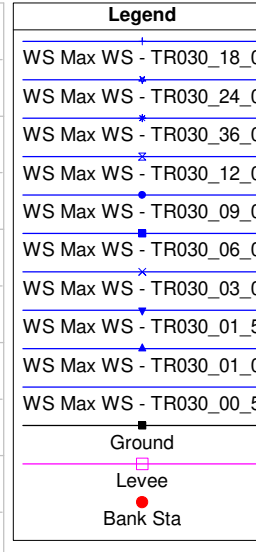
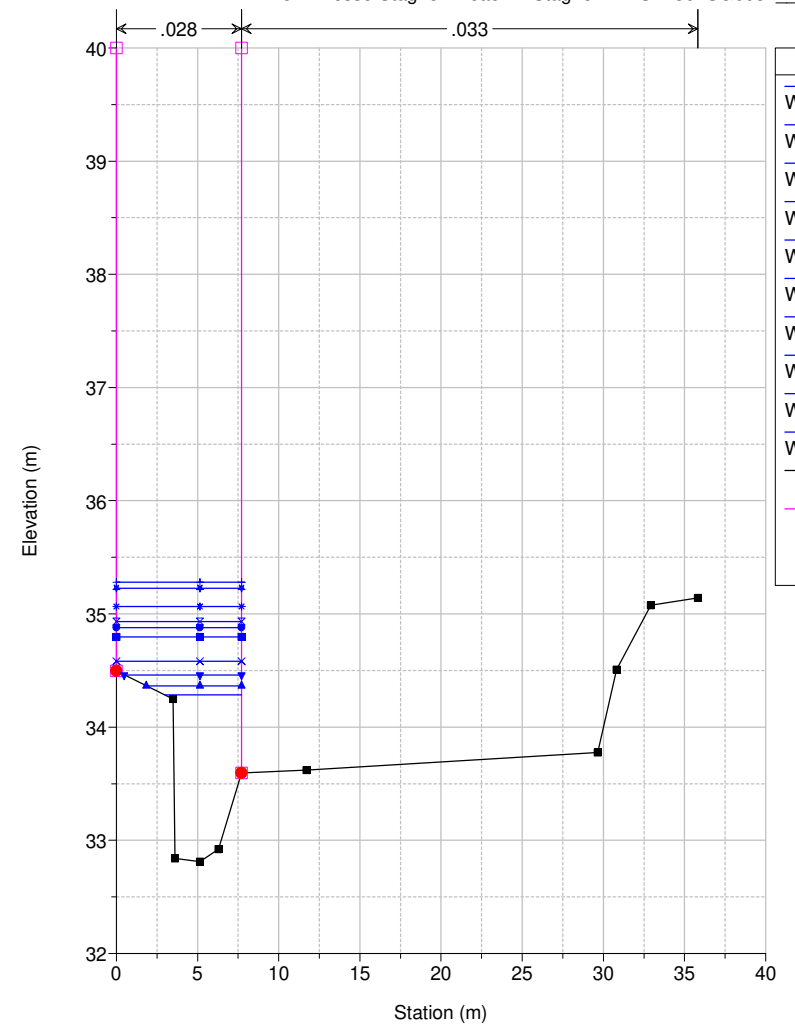

Studio Scandicci Torrenti Greve-Vingone
River = Fosso Stagno Reach = Stagno RS = 35 SG0032__

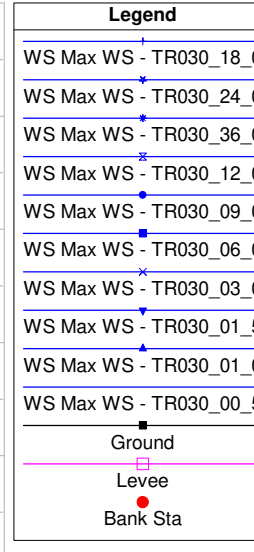
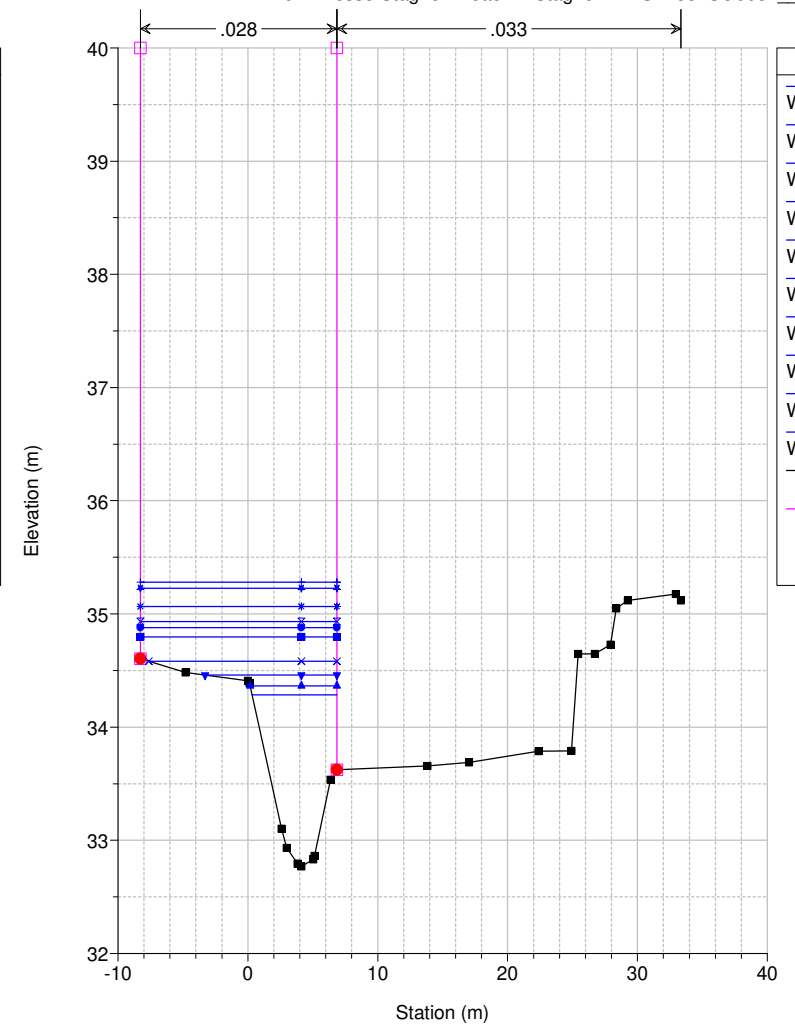

Studio Scandicci Torrenti Greve-Vingone
River = Fosso Stagno Reach = Stagno RS = 34 SG0033

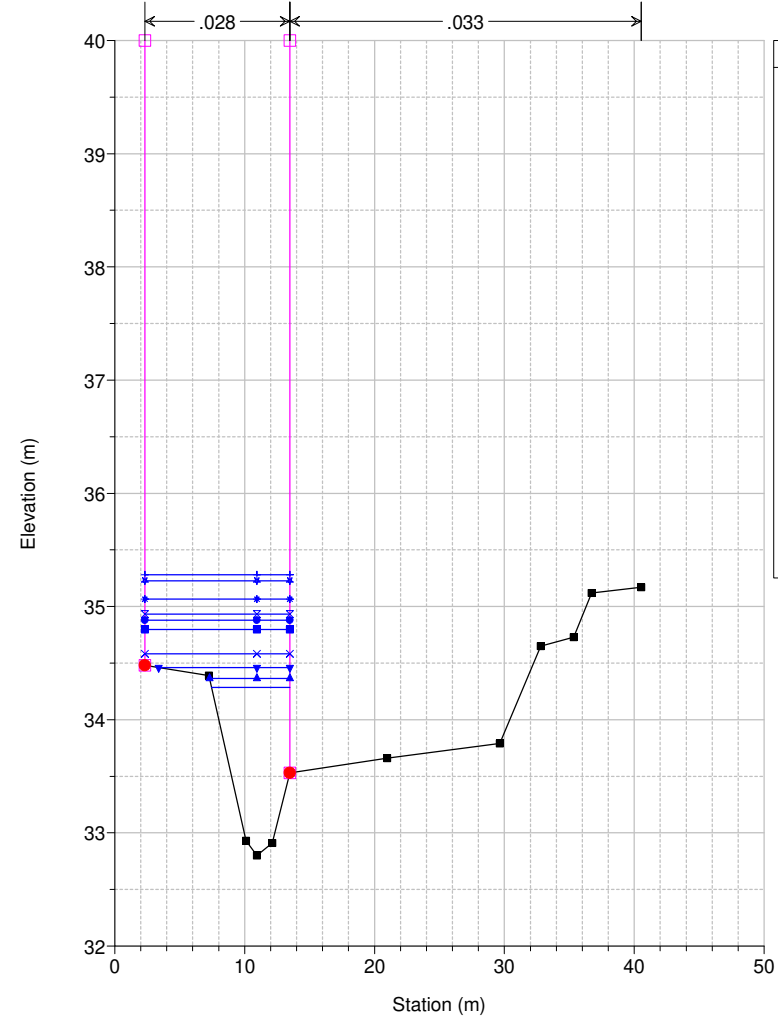

Legend

- WS Max WS - TR030_18_0
- WS Max WS - TR030_24_0
- WS Max WS - TR030_36_0
- WS Max WS - TR030_12_0
- WS Max WS - TR030_09_0
- WS Max WS - TR030_06_0
- WS Max WS - TR030_03_0
- WS Max WS - TR030_01_5
- WS Max WS - TR030_01_0
- WS Max WS - TR030_00_5
- Ground
- Levee
- Bank Sta

Studio Scandicci Torrenti Greve-Vingone
River = Fosso Stagno Reach = Stagno RS = 33 SG0034

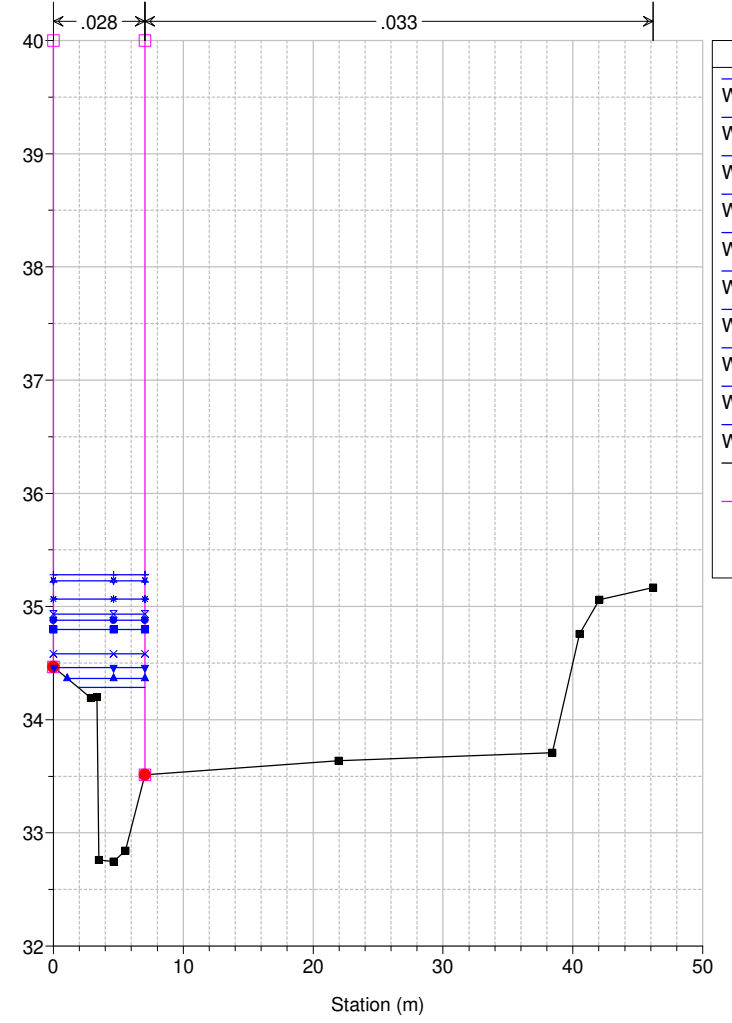

Legend

- WS Max WS - TR030_18_0
- WS Max WS - TR030_24_0
- WS Max WS - TR030_36_0
- WS Max WS - TR030_12_0
- WS Max WS - TR030_09_0
- WS Max WS - TR030_06_0
- WS Max WS - TR030_03_0
- WS Max WS - TR030_01_5
- WS Max WS - TR030_01_0
- WS Max WS - TR030_00_5
- Ground
- Levee
- Bank Sta

Studio Scandicci Torrenti Greve-Vingone
River = Fosso Stagno Reach = Stagno RS = 32 SG0035

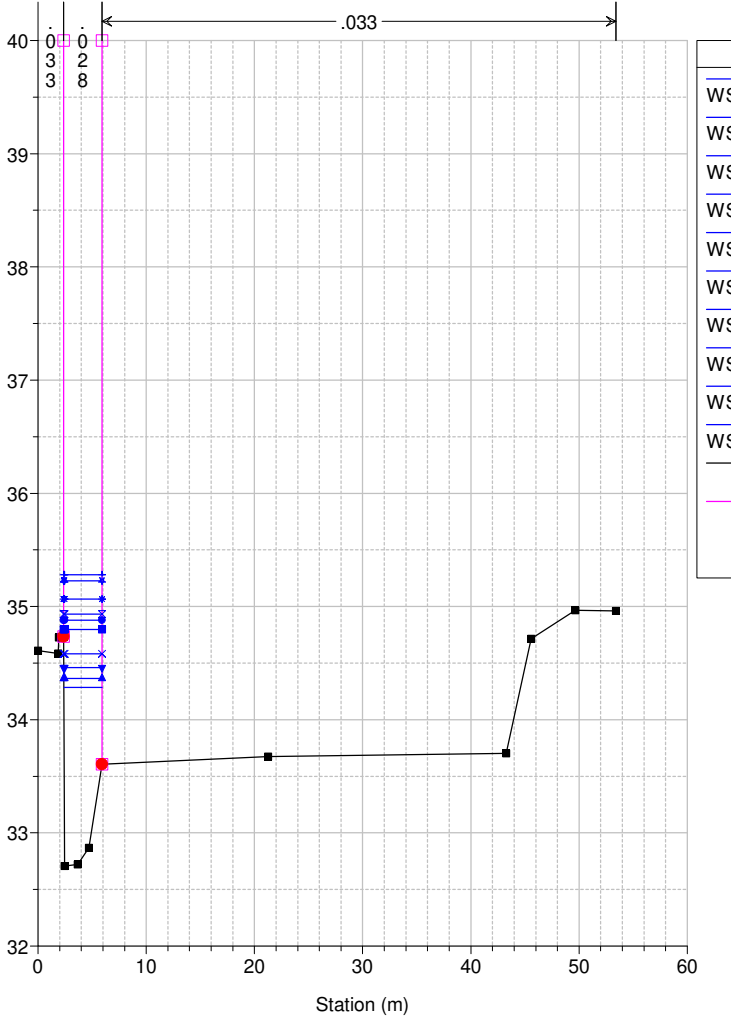

Legend

- WS Max WS - TR030_18_0
- WS Max WS - TR030_24_0
- WS Max WS - TR030_36_0
- WS Max WS - TR030_12_0
- WS Max WS - TR030_09_0
- WS Max WS - TR030_06_0
- WS Max WS - TR030_03_0
- WS Max WS - TR030_01_5
- WS Max WS - TR030_01_0
- WS Max WS - TR030_00_5
- Ground
- Levee
- Bank Sta

Studio Scandicci Torrenti Greve-Vingone
River = Fosso Stagno Reach = Stagno RS = 31 SG0036

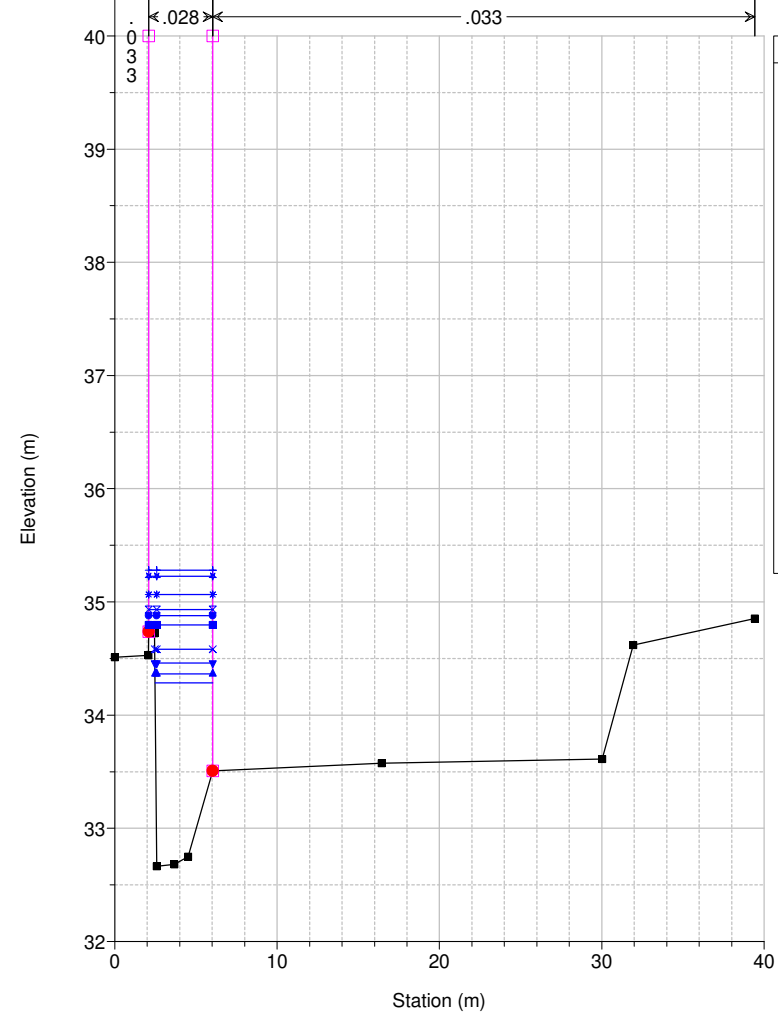

Legend

- WS Max WS - TR030_18_0
- WS Max WS - TR030_24_0
- WS Max WS - TR030_36_0
- WS Max WS - TR030_12_0
- WS Max WS - TR030_09_0
- WS Max WS - TR030_06_0
- WS Max WS - TR030_03_0
- WS Max WS - TR030_01_5
- WS Max WS - TR030_01_0
- WS Max WS - TR030_00_5
- Ground
- Levee
- Bank Sta

Studio Scandicci Torrenti Greve-Vingone
River = Fosso Stagno Reach = Stagno RS = 30 SG0037

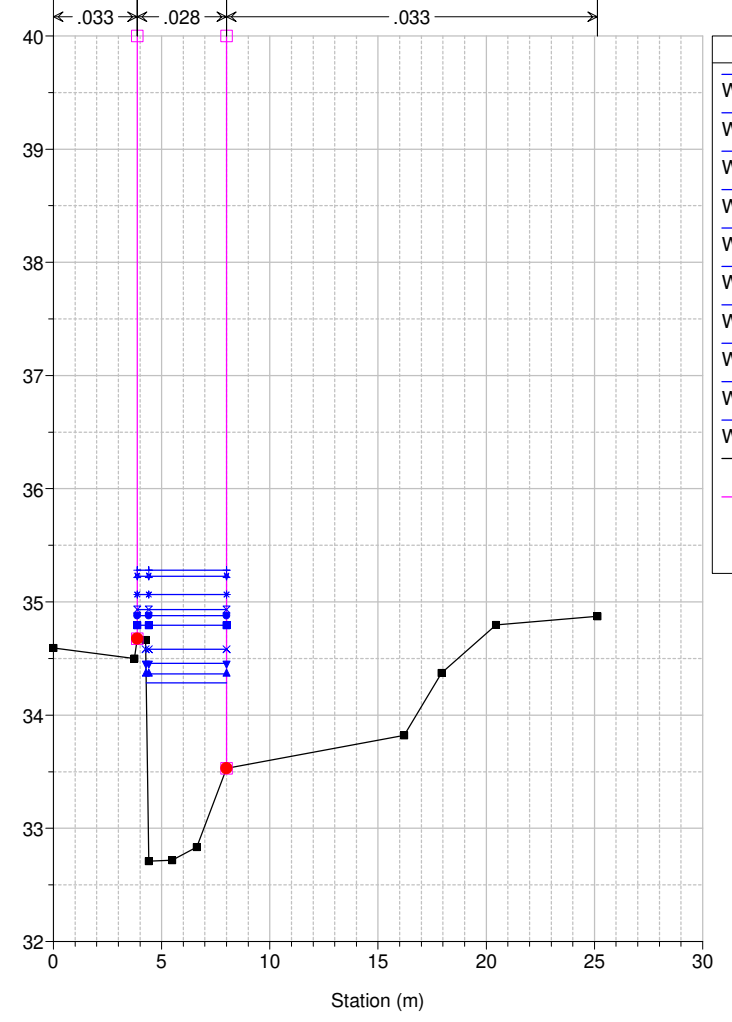

Legend

- WS Max WS - TR030_18_0
- WS Max WS - TR030_24_0
- WS Max WS - TR030_36_0
- WS Max WS - TR030_12_0
- WS Max WS - TR030_09_0
- WS Max WS - TR030_06_0
- WS Max WS - TR030_03_0
- WS Max WS - TR030_01_5
- WS Max WS - TR030_01_0
- WS Max WS - TR030_00_5
- Ground
- Levee
- Bank Sta

Studio Scandicci Torrenti Greve-Vingone
River = Fosso Stagno Reach = Stagno RS = 29 SG0038_A

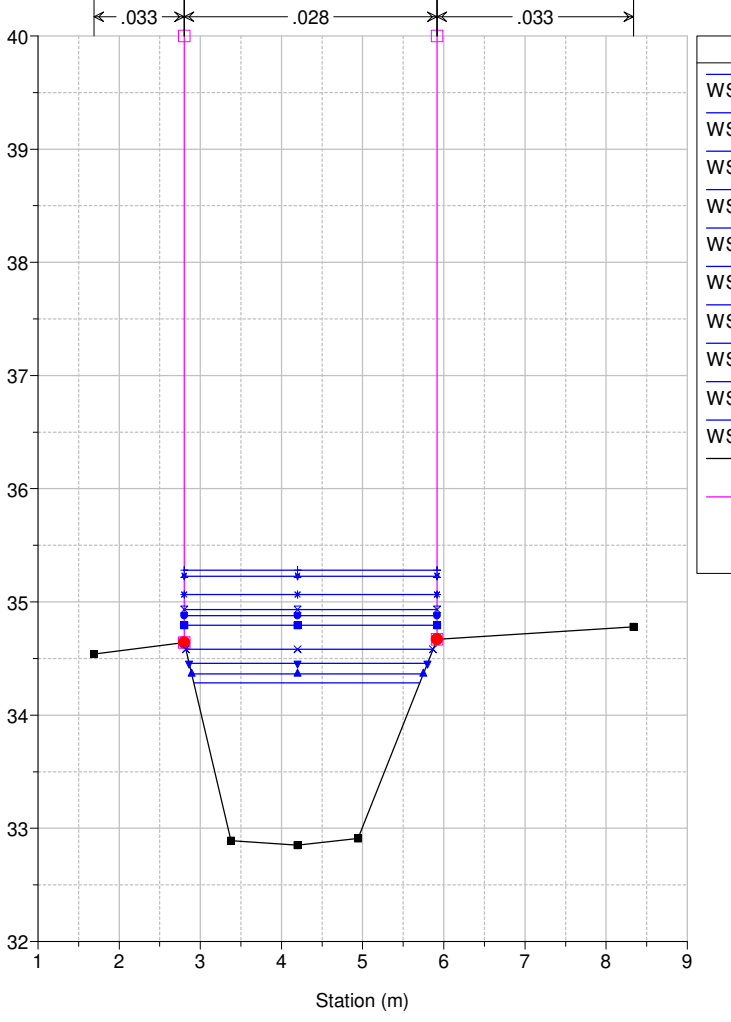

Legend

- WS Max WS - TR030_18_0
- WS Max WS - TR030_24_0
- WS Max WS - TR030_36_0
- WS Max WS - TR030_12_0
- WS Max WS - TR030_09_0
- WS Max WS - TR030_06_0
- WS Max WS - TR030_03_0
- WS Max WS - TR030_01_5
- WS Max WS - TR030_01_0
- WS Max WS - TR030_00_5
- Ground
- Levee
- Bank Sta

Studio Scandicci Torrenti Greve-Vingone
River = Fosso Stagno Reach = Stagno RS = 28 SG0038_B

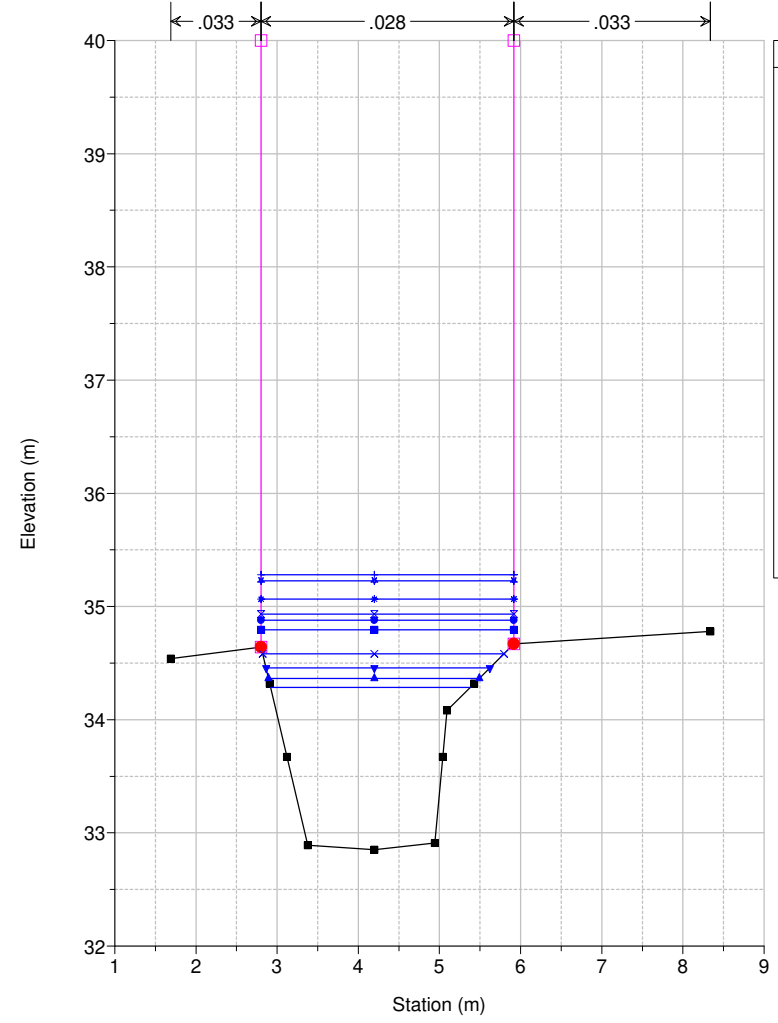

Legend

- WS Max WS - TR030_18_0
- WS Max WS - TR030_24_0
- WS Max WS - TR030_36_0
- WS Max WS - TR030_12_0
- WS Max WS - TR030_09_0
- WS Max WS - TR030_06_0
- WS Max WS - TR030_03_0
- WS Max WS - TR030_01_5
- WS Max WS - TR030_01_0
- WS Max WS - TR030_00_5
- Ground
- Levee
- Bank Sta

Studio Scandicci Torrenti Greve-Vingone
River = Fosso Stagno Reach = Stagno RS = 27.5 BR

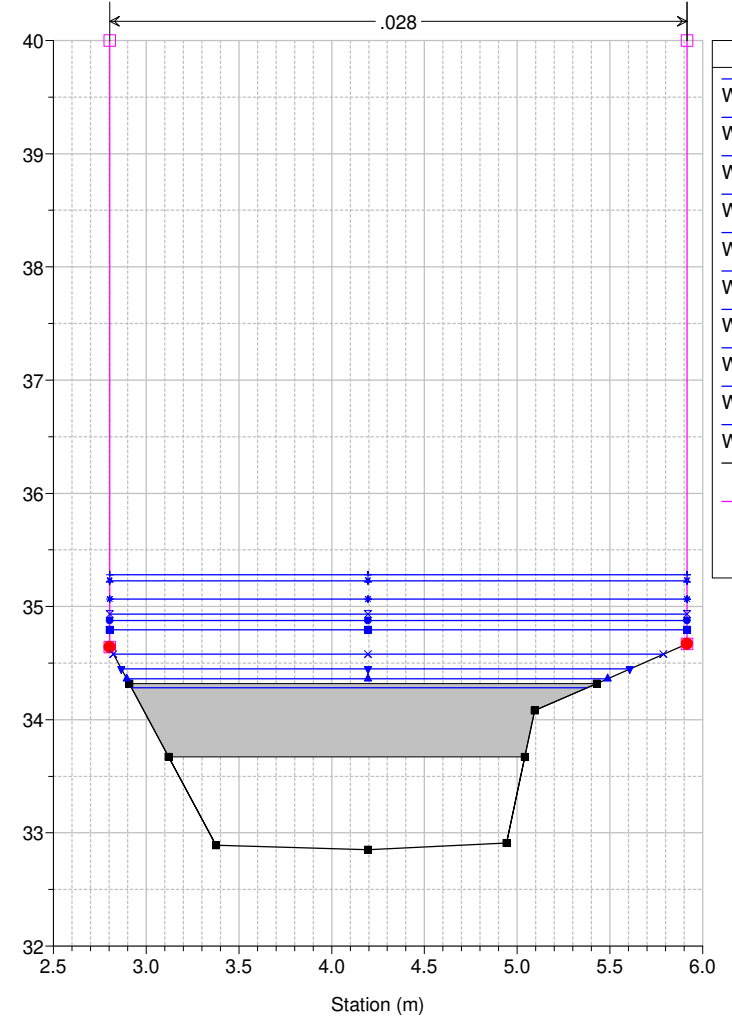

Legend

- WS Max WS - TR030_18_0
- WS Max WS - TR030_24_0
- WS Max WS - TR030_36_0
- WS Max WS - TR030_12_0
- WS Max WS - TR030_09_0
- WS Max WS - TR030_06_0
- WS Max WS - TR030_03_0
- WS Max WS - TR030_01_5
- WS Max WS - TR030_01_0
- WS Max WS - TR030_00_5
- Ground
- Levee
- Bank Sta

Studio Scandicci Torrenti Greve-Vingone
River = Fosso Stagno Reach = Stagno RS = 27.5 BR

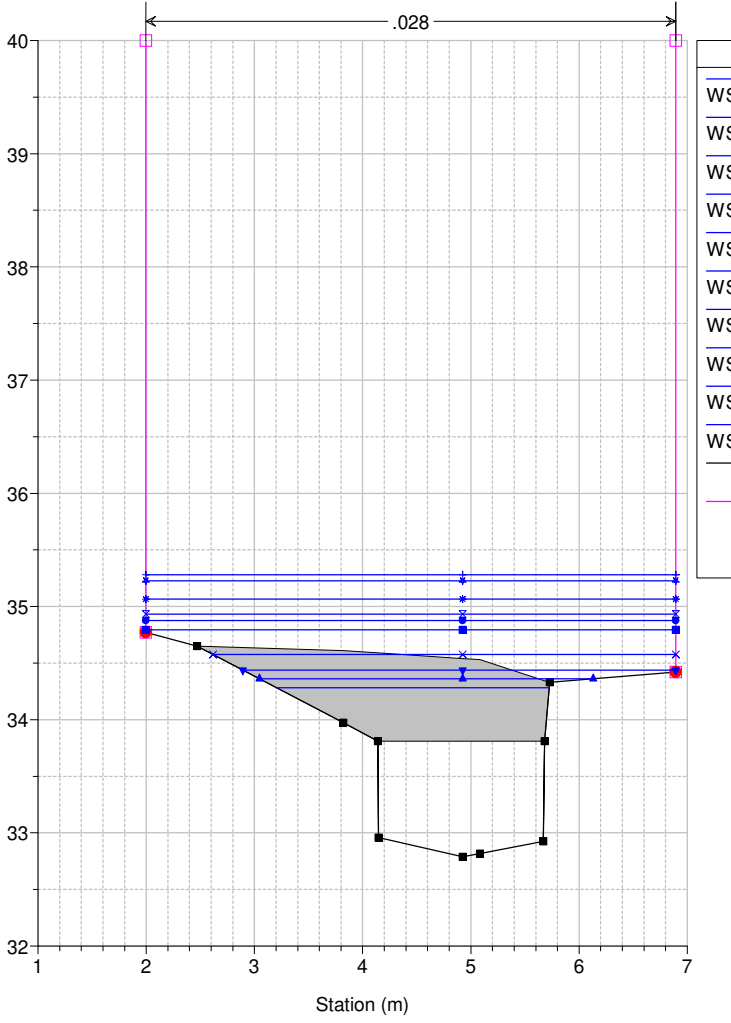

Legend

- WS Max WS - TR030_18_0
- WS Max WS - TR030_24_0
- WS Max WS - TR030_36_0
- WS Max WS - TR030_12_0
- WS Max WS - TR030_09_0
- WS Max WS - TR030_06_0
- WS Max WS - TR030_03_0
- WS Max WS - TR030_01_5
- WS Max WS - TR030_01_0
- WS Max WS - TR030_00_5
- Ground
- Levee
- Bank Sta

Studio Scandicci Torrenti Greve-Vingone
River = Fosso Stagno Reach = Stagno RS = 27 SG0038_C

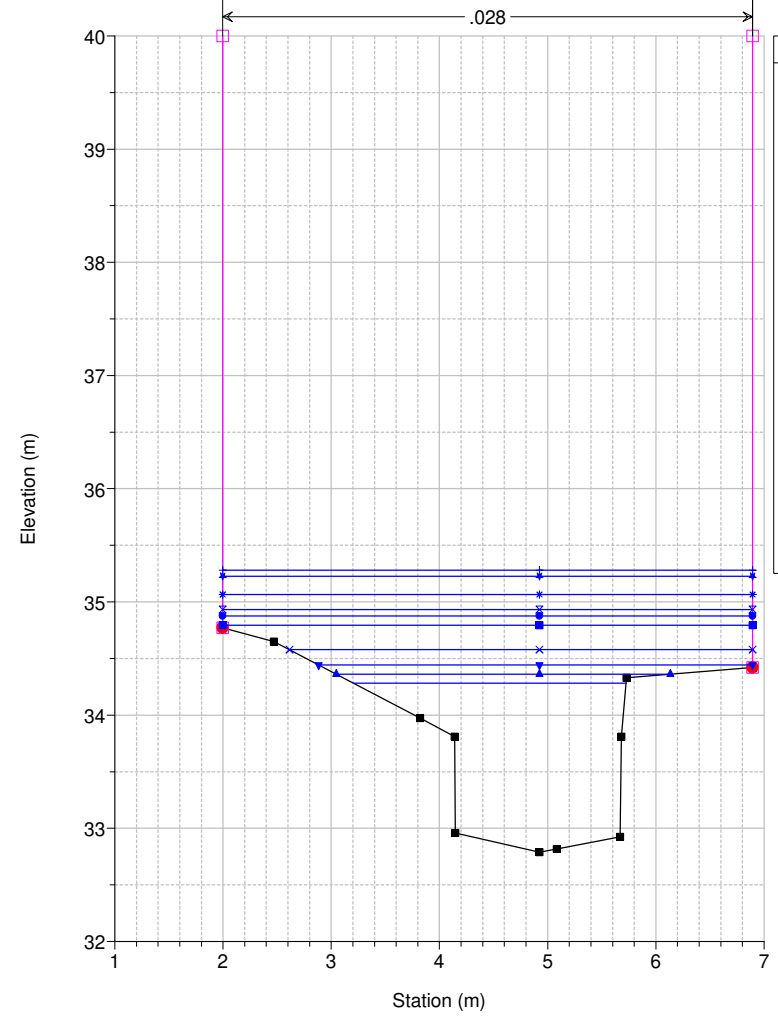

Legend

- WS Max WS - TR030_18_0
- WS Max WS - TR030_24_0
- WS Max WS - TR030_36_0
- WS Max WS - TR030_12_0
- WS Max WS - TR030_09_0
- WS Max WS - TR030_06_0
- WS Max WS - TR030_03_0
- WS Max WS - TR030_01_5
- WS Max WS - TR030_01_0
- WS Max WS - TR030_00_5
- Ground
- Levee
- Bank Sta

Studio Scandicci Torrenti Greve-Vingone
River = Fosso Stagno Reach = Stagno RS = 26 SG0038_D

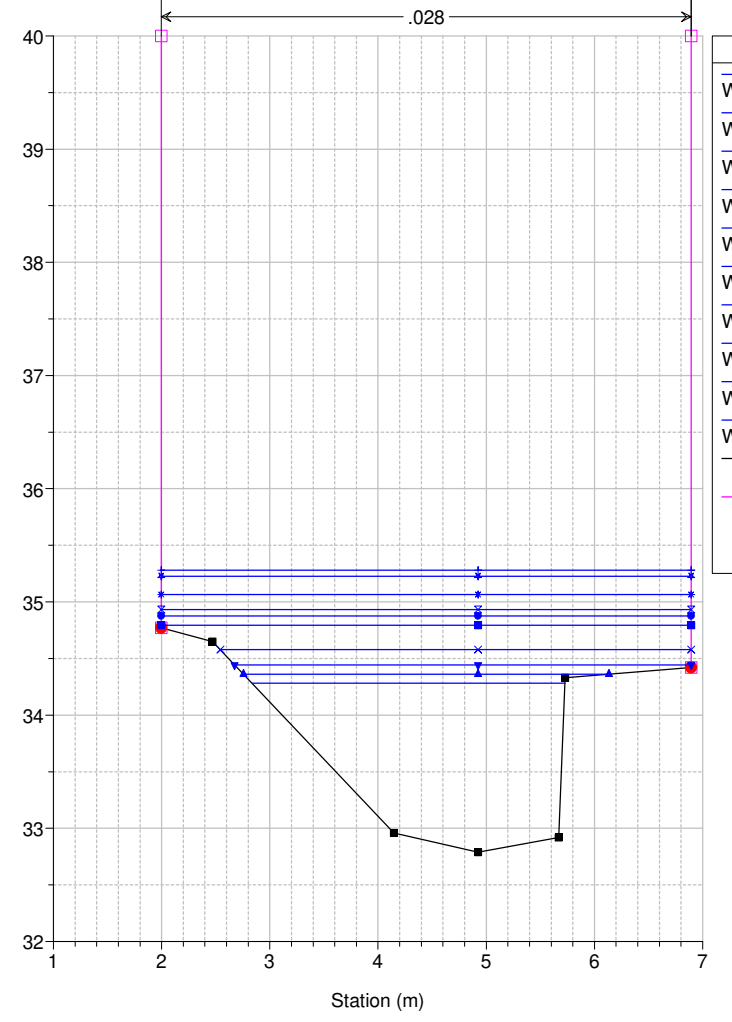

Legend

- WS Max WS - TR030_18_0
- WS Max WS - TR030_24_0
- WS Max WS - TR030_36_0
- WS Max WS - TR030_12_0
- WS Max WS - TR030_09_0
- WS Max WS - TR030_06_0
- WS Max WS - TR030_03_0
- WS Max WS - TR030_01_5
- WS Max WS - TR030_01_0
- WS Max WS - TR030_00_5
- Ground
- Levee
- Bank Sta

Studio Scandicci Torrenti Greve-Vingone
River = Fosso Stagno Reach = Stagno RS = 25 SG0039_A

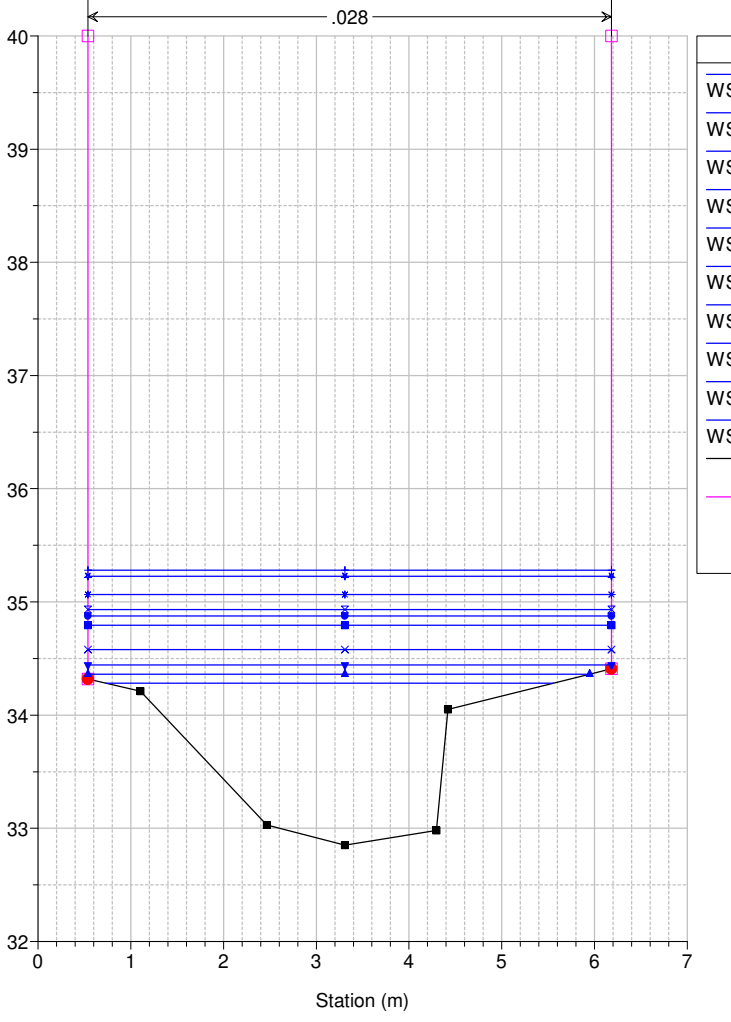

Legend

- WS Max WS - TR030_18_0
- WS Max WS - TR030_24_0
- WS Max WS - TR030_36_0
- WS Max WS - TR030_12_0
- WS Max WS - TR030_09_0
- WS Max WS - TR030_06_0
- WS Max WS - TR030_03_0
- WS Max WS - TR030_01_5
- WS Max WS - TR030_01_0
- WS Max WS - TR030_00_5
- Ground
- Levee
- Bank Sta

Studio Scandicci Torrenti Greve-Vingone
River = Fosso Stagno Reach = Stagno RS = 24 SG0039_B

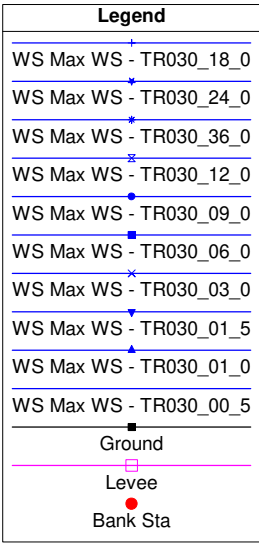
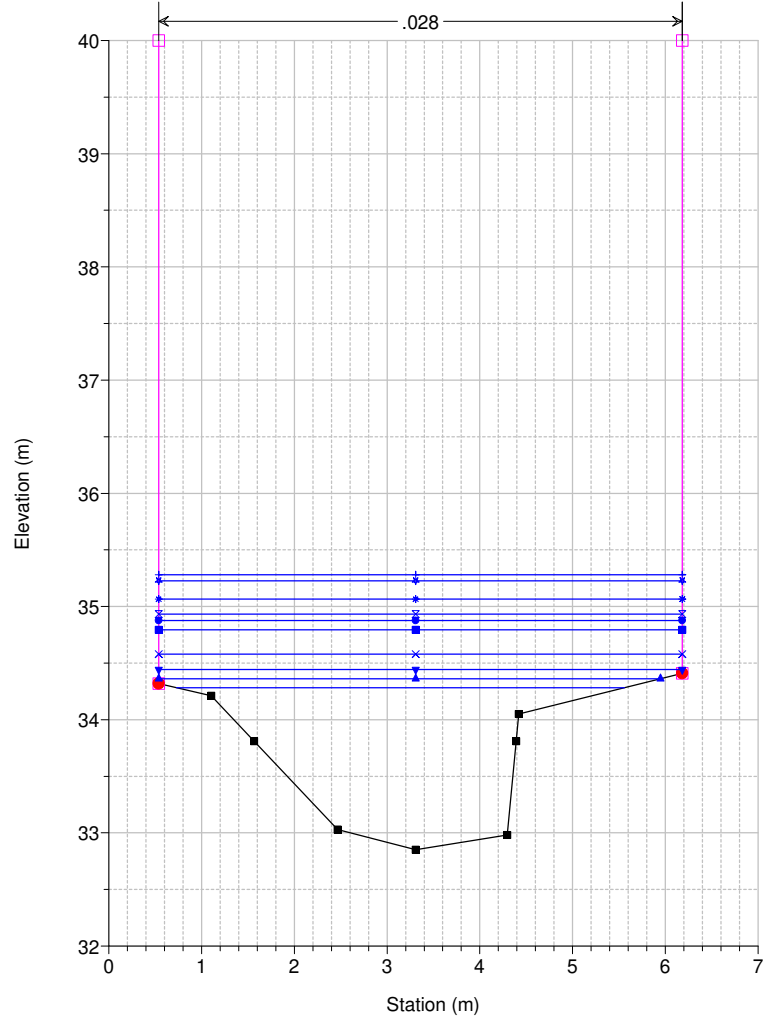

Studio Scandicci Torrenti Greve-Vingone
River = Fosso Stagno Reach = Stagno RS = 23.5 BR

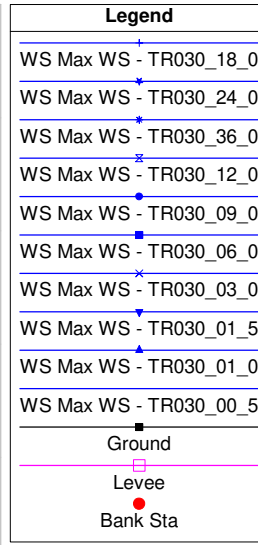
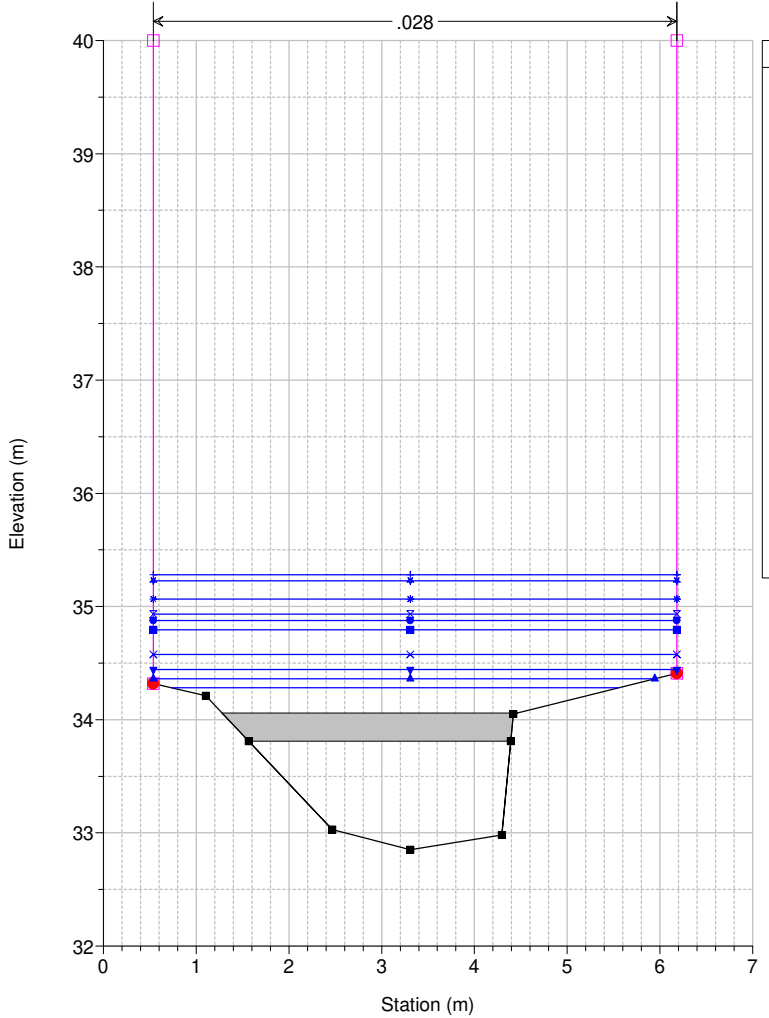

Studio Scandicci Torrenti Greve-Vingone
River = Fosso Stagno Reach = Stagno RS = 23.5 BR

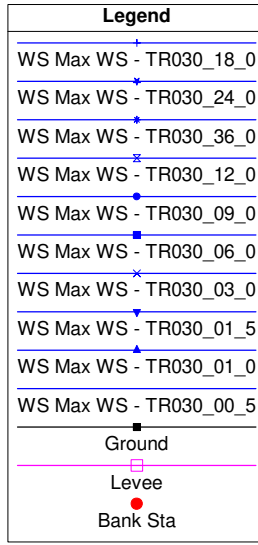
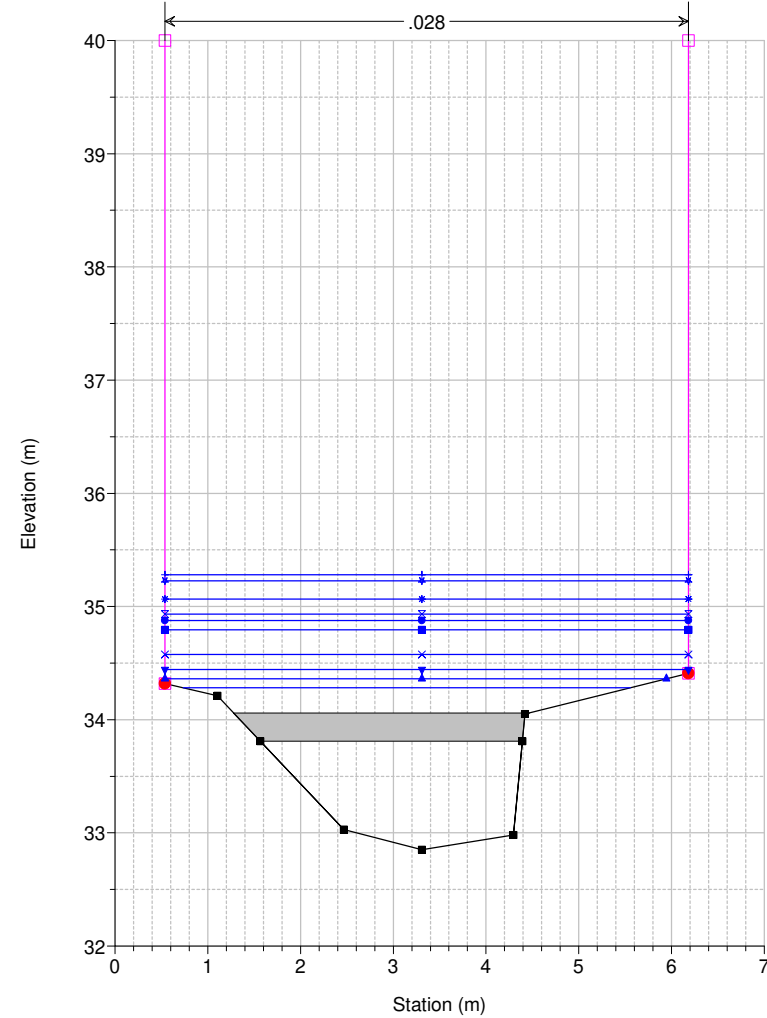

Studio Scandicci Torrenti Greve-Vingone
River = Fosso Stagno Reach = Stagno RS = 23 SG0039_C

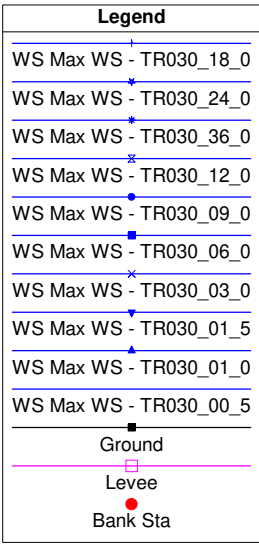
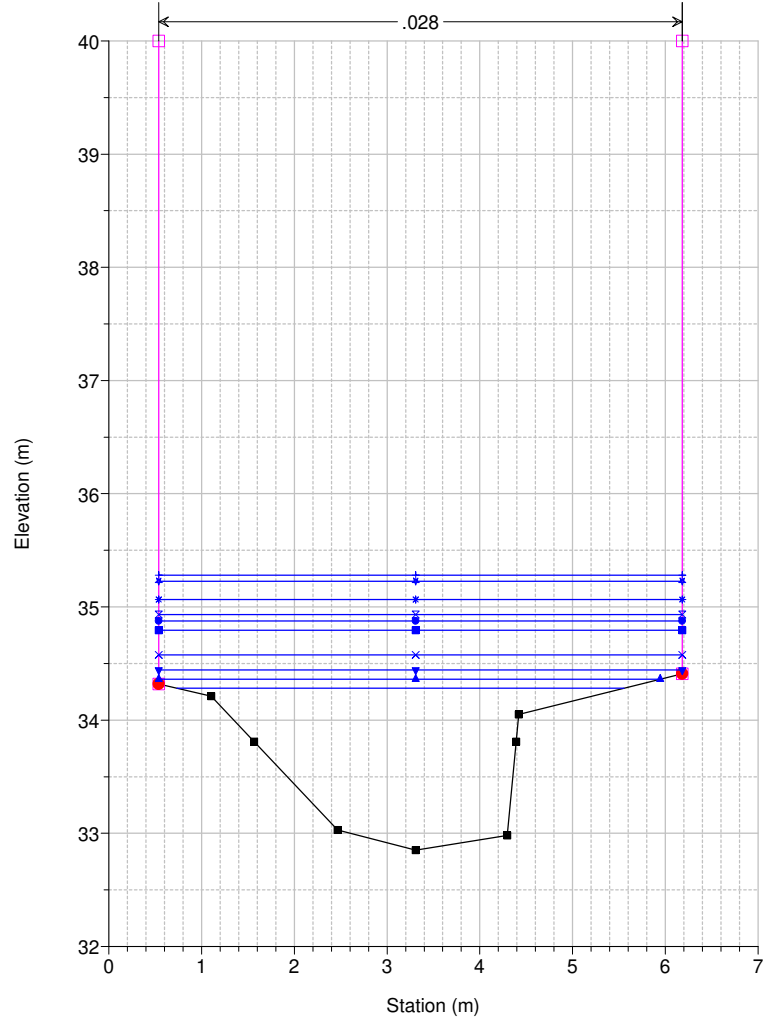

Studio Scandicci Torrenti Greve-Vingone
River = Fosso Stagno Reach = Stagno RS = 22 SG0039_D

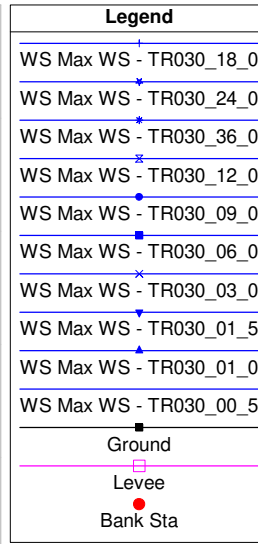
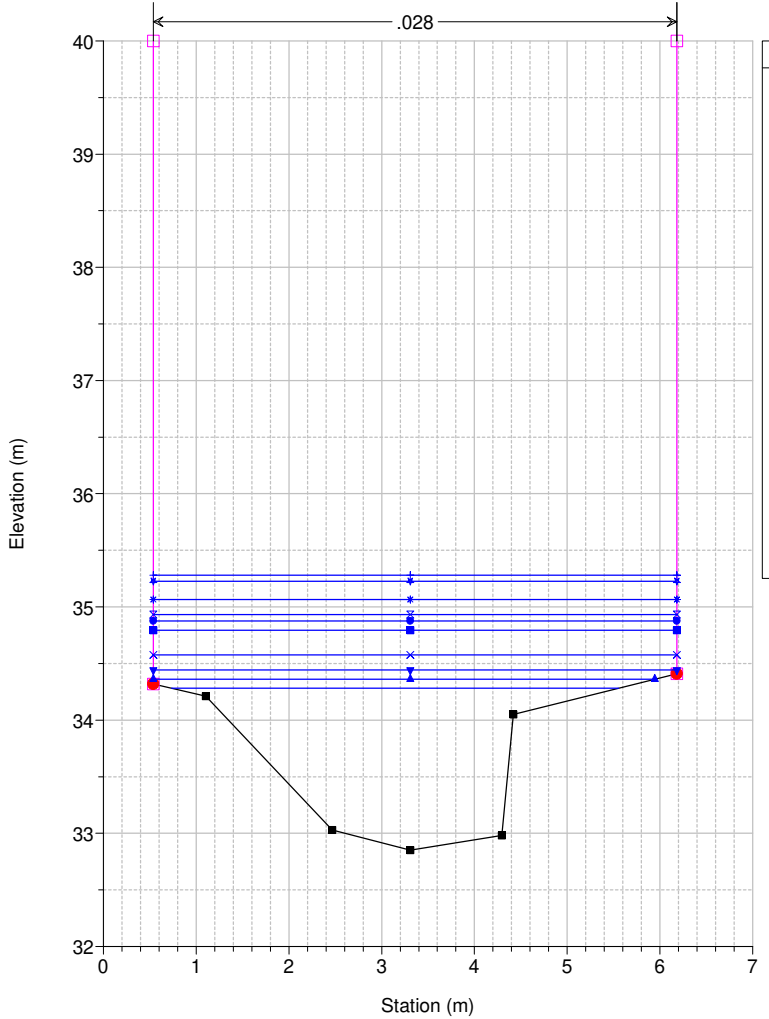

Studio Scandicci Torrenti Greve-Vingone
River = Fosso Stagno Reach = Stagno RS = 21 SG0040_

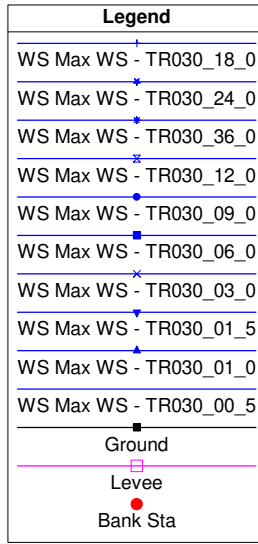
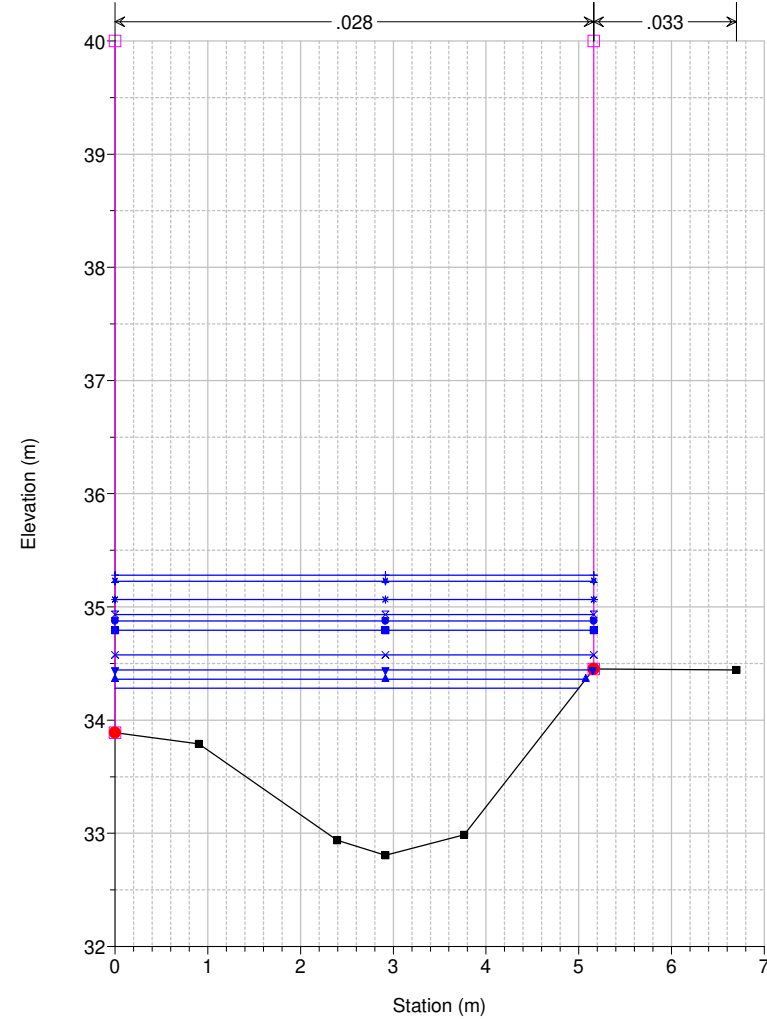

Studio Scandicci Torrenti Greve-Vingone
River = Fosso Stagno Reach = Stagno RS = 20 SG0041__

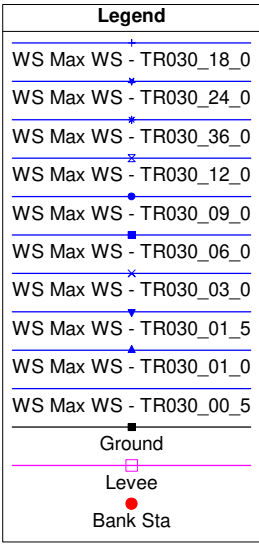
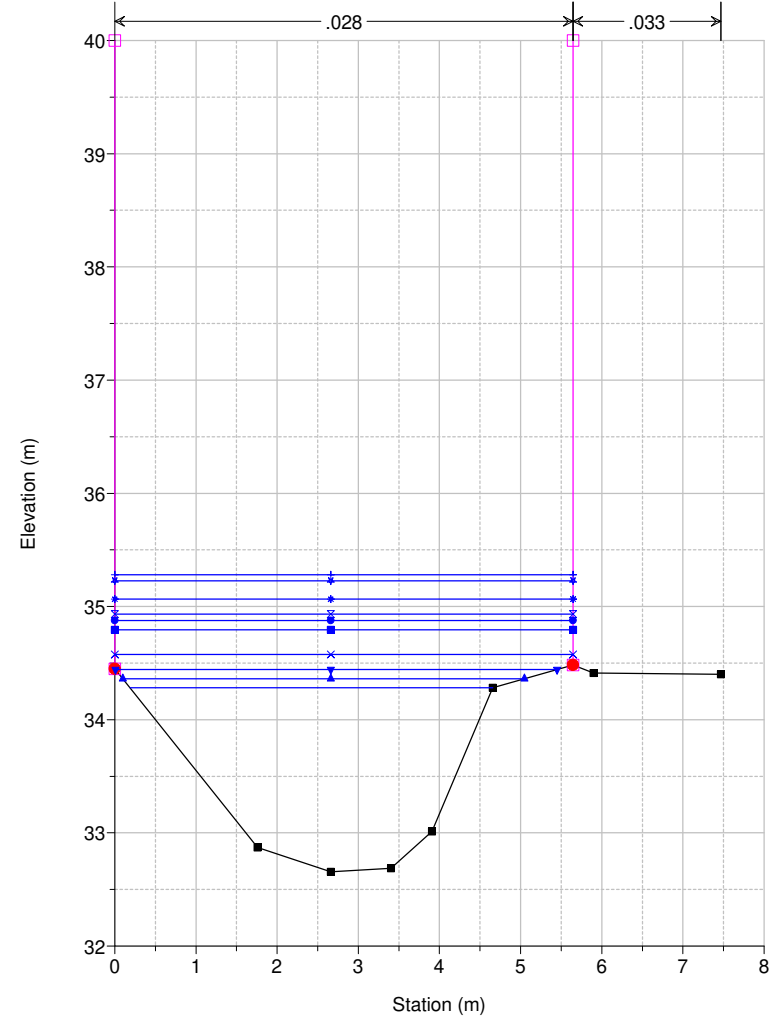

Studio Scandicci Torrenti Greve-Vingone
River = Fosso Stagno Reach = Stagno RS = 19 SG0042__

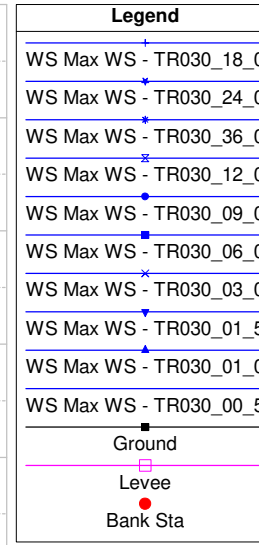
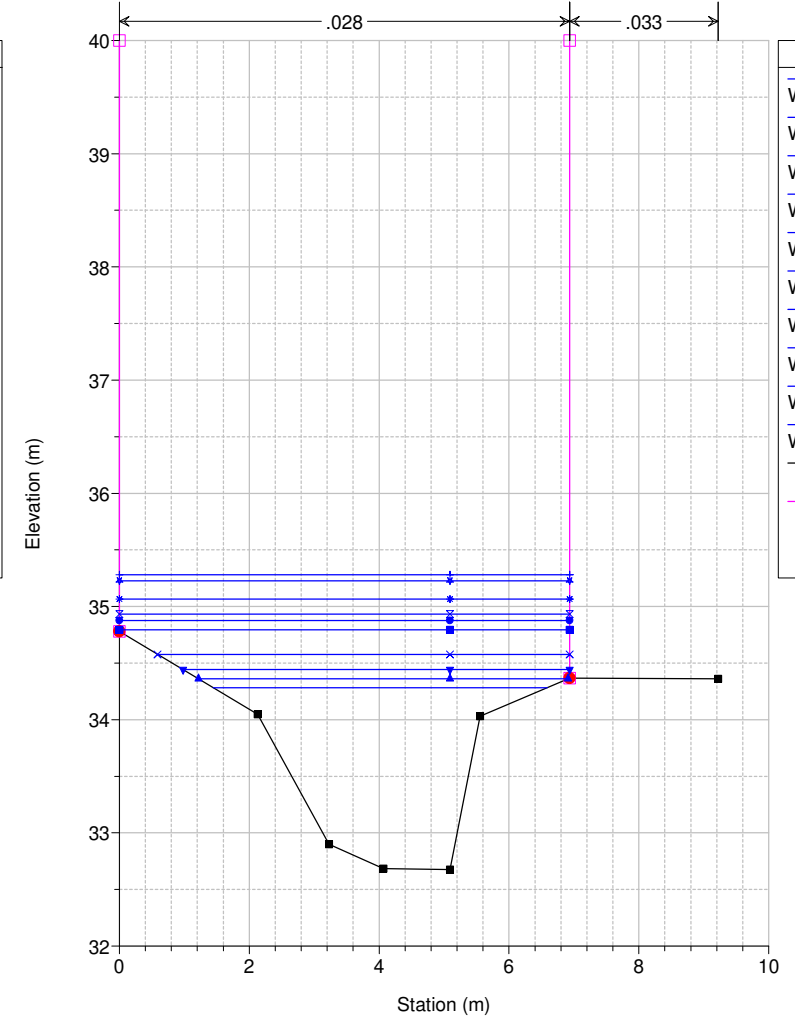

Studio Scandicci Torrenti Greve-Vingone
River = Fosso Stagno Reach = Stagno RS = 18 SG0043__

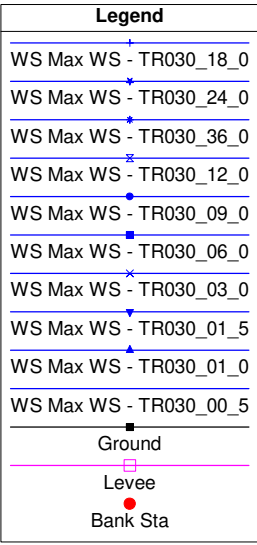
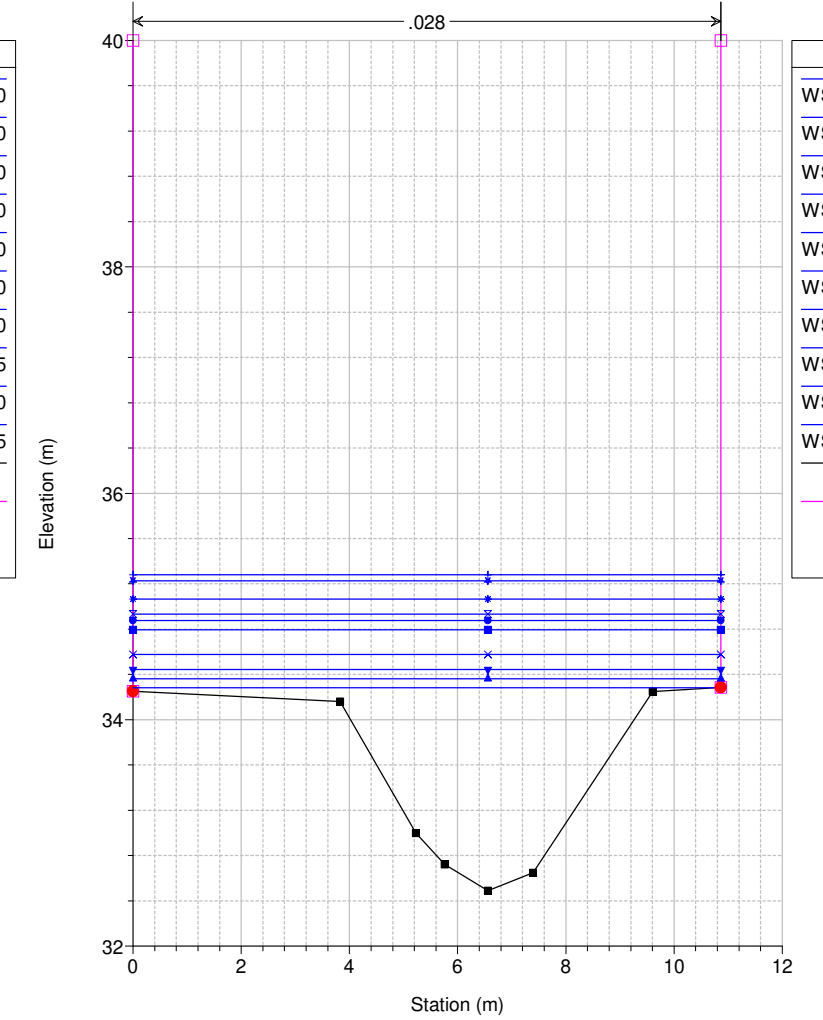

Studio Scandicci Torrenti Greve-Vingone
River = Fosso Stagno Reach = Stagno RS = 17 SG0044__

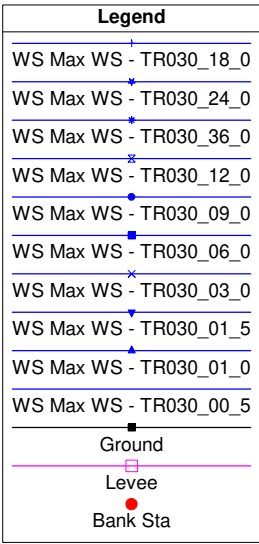
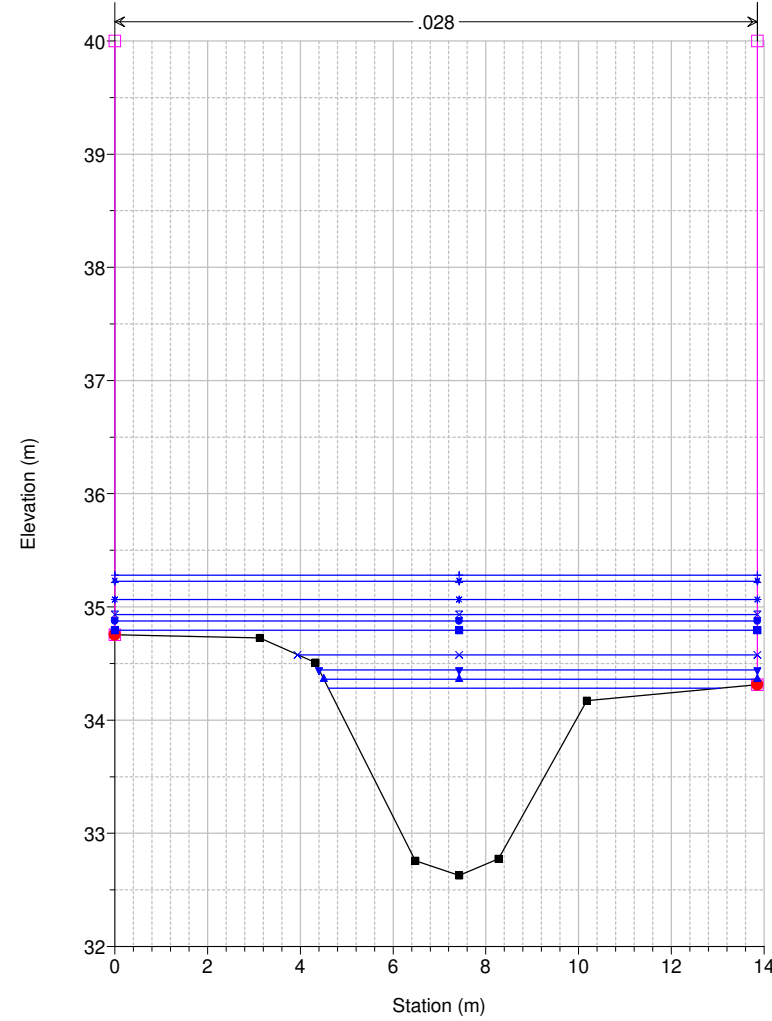

Studio Scandicci Torrenti Greve-Vingone
River = Fosso Stagno Reach = Stagno RS = 16 SG0045__

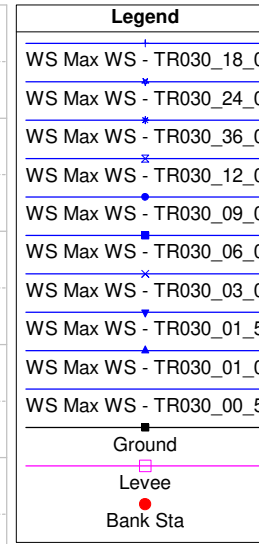
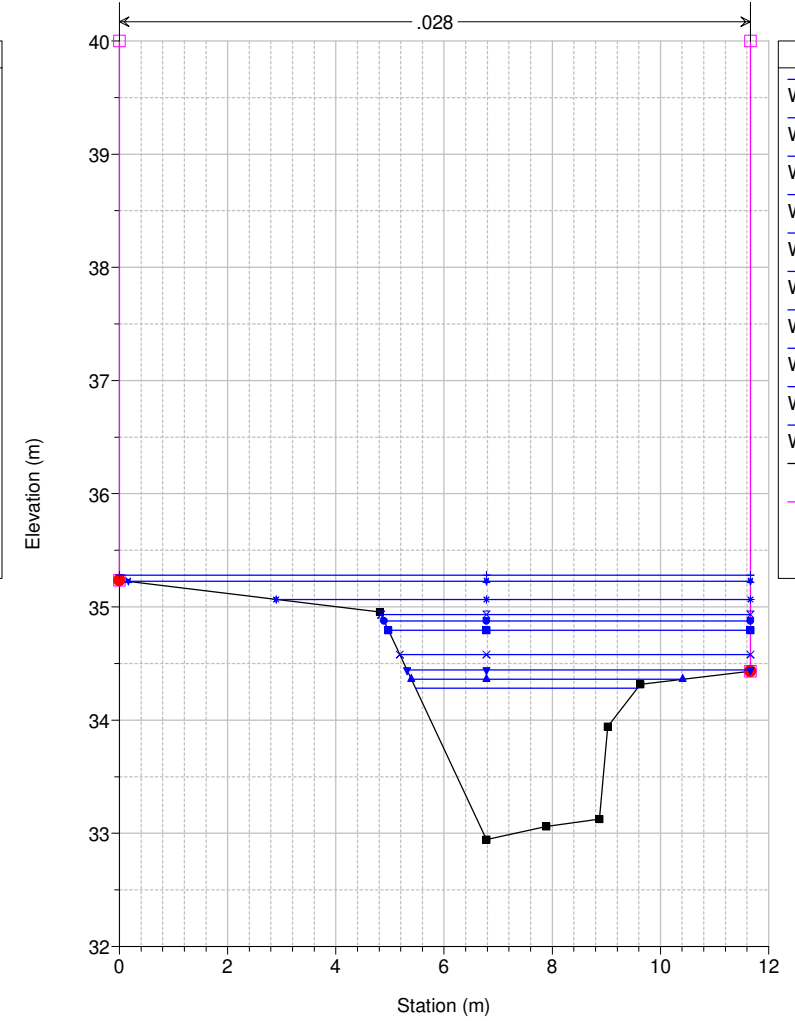

Studio Scandicci Torrenti Greve-Vingone
River = Fosso Stagno Reach = Stagno RS = 15 SG0046_A

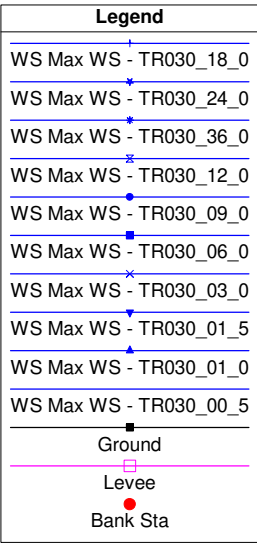
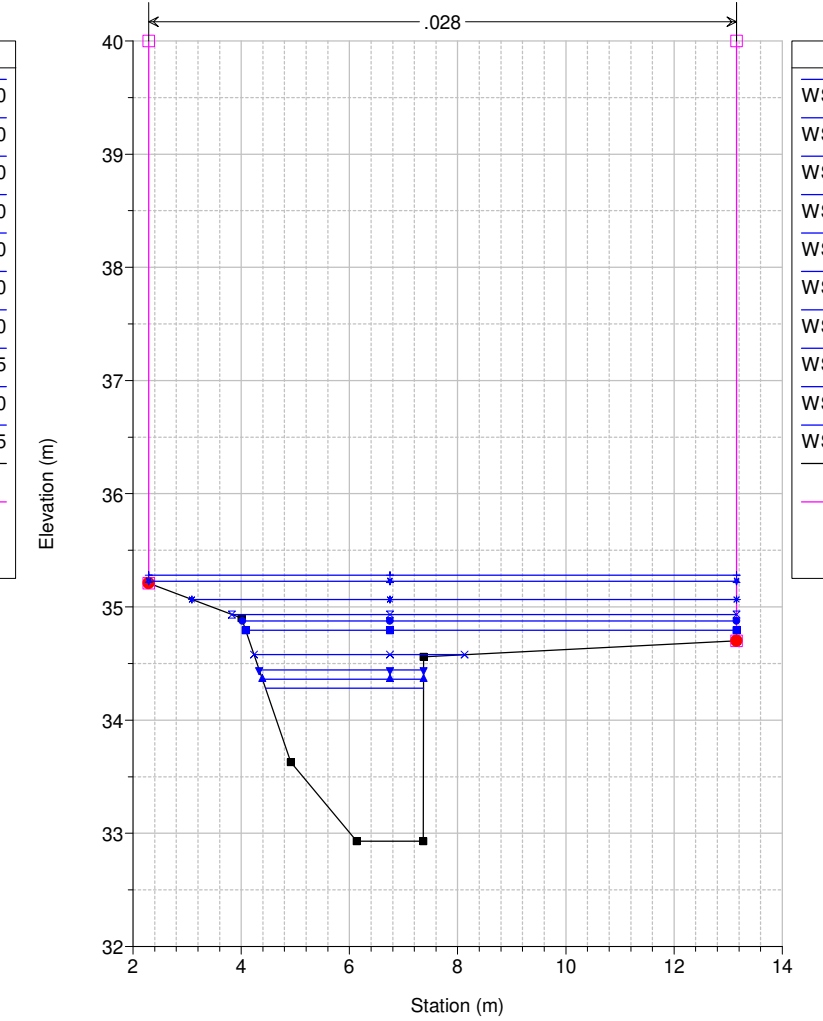

Studio Scandicci Torrenti Greve-Vingone
River = Fosso Stagno Reach = Stagno RS = 14 SG0046_B

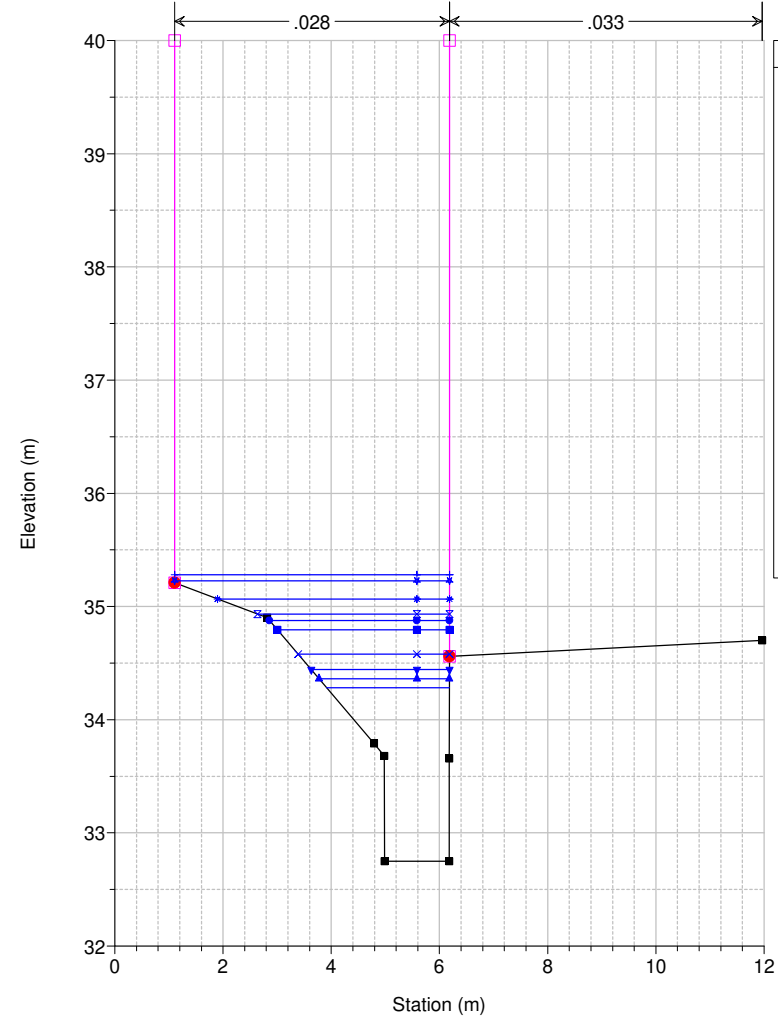

Studio Scandicci Torrenti Greve-Vingone
River = Fosso Stagno Reach = Stagno RS = 13.5 BR

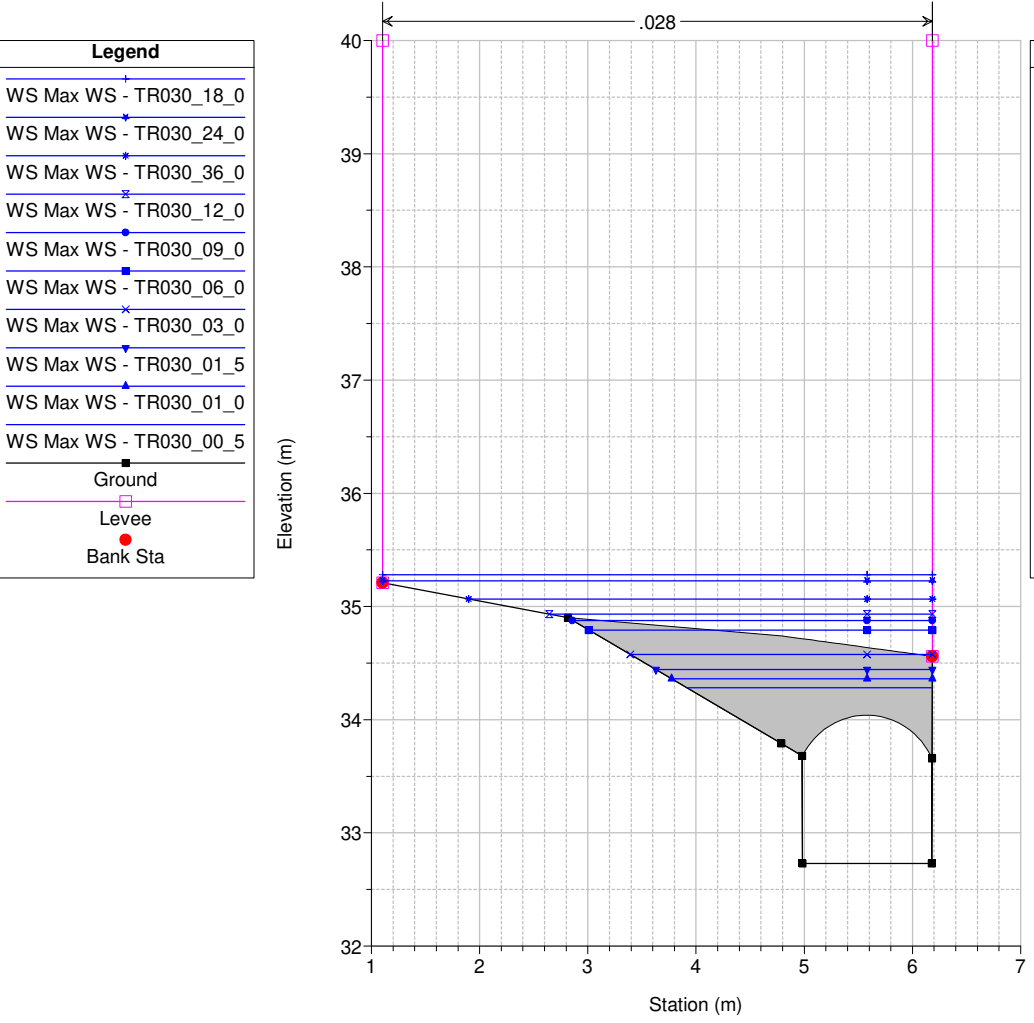

Studio Scandicci Torrenti Greve-Vingone
River = Fosso Stagno Reach = Stagno RS = 13.5 BR

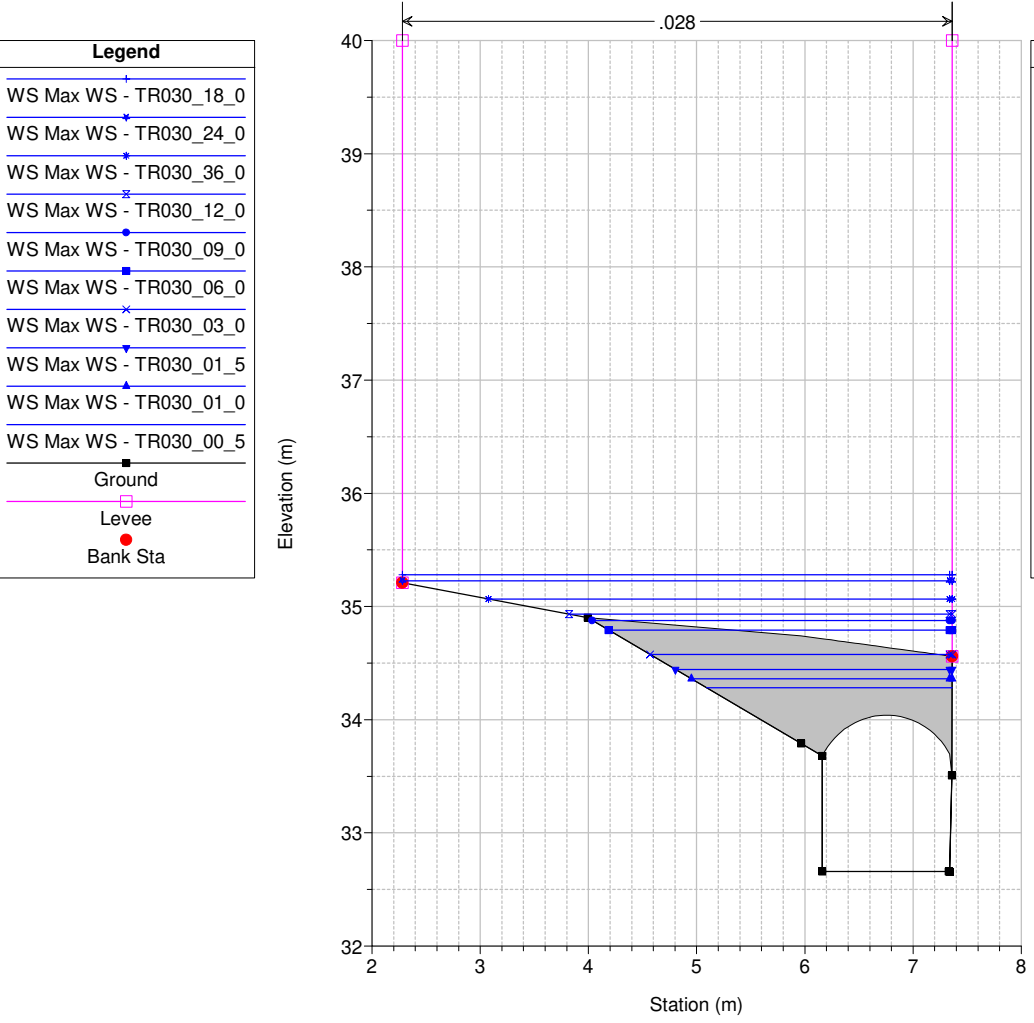

Studio Scandicci Torrenti Greve-Vingone
River = Fosso Stagno Reach = Stagno RS = 13 SG0046_C

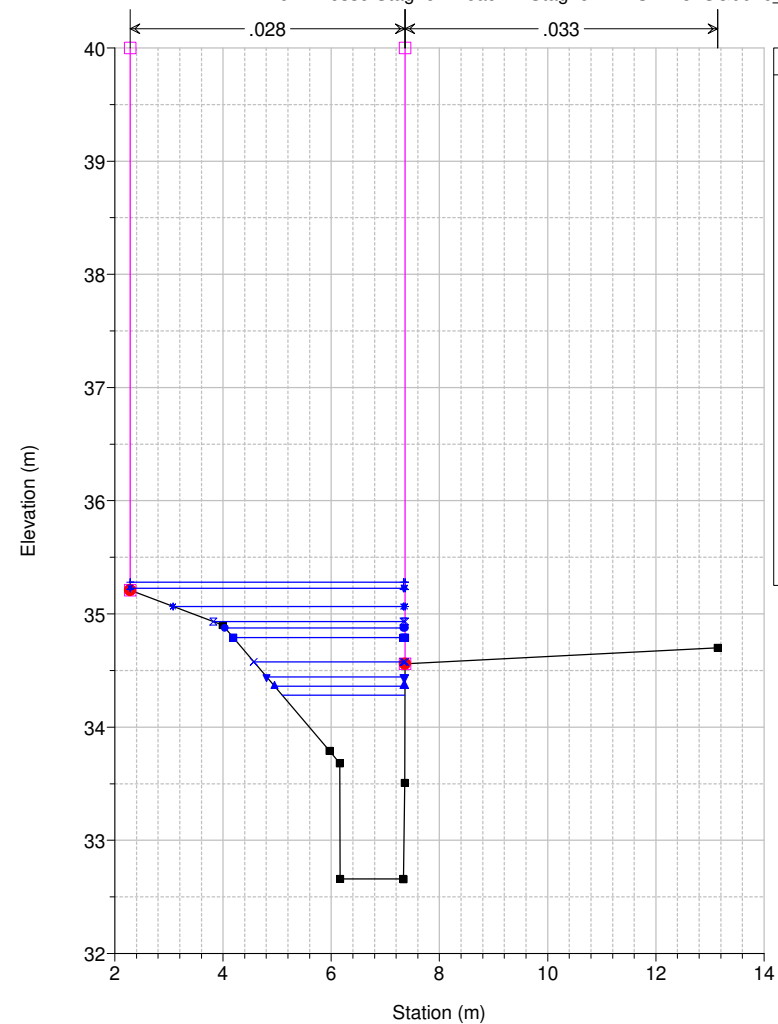

Studio Scandicci Torrenti Greve-Vingone
River = Fosso Stagno Reach = Stagno RS = 12 SG0046_D

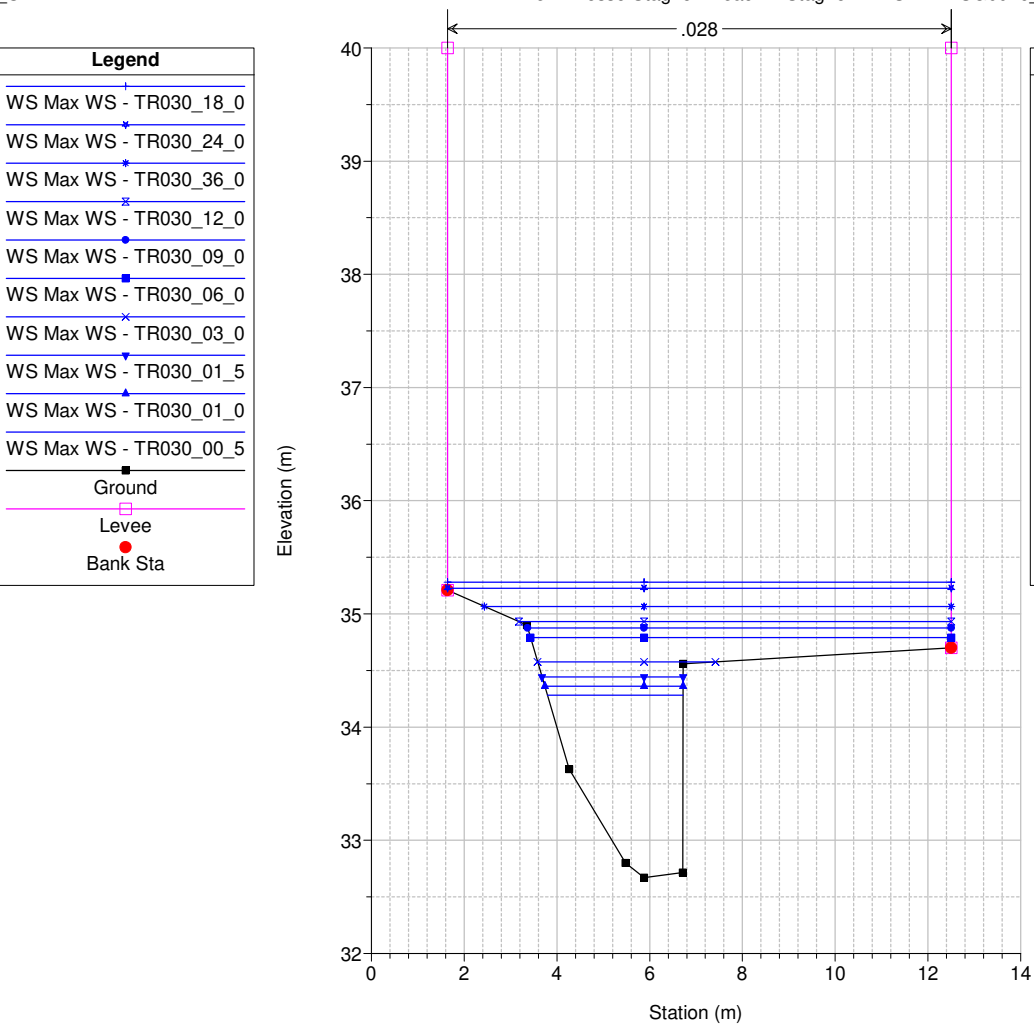

Studio Scandicci Torrenti Greve-Vingone
River = Fosso Stagno Reach = Stagno RS = 11 SG0047_

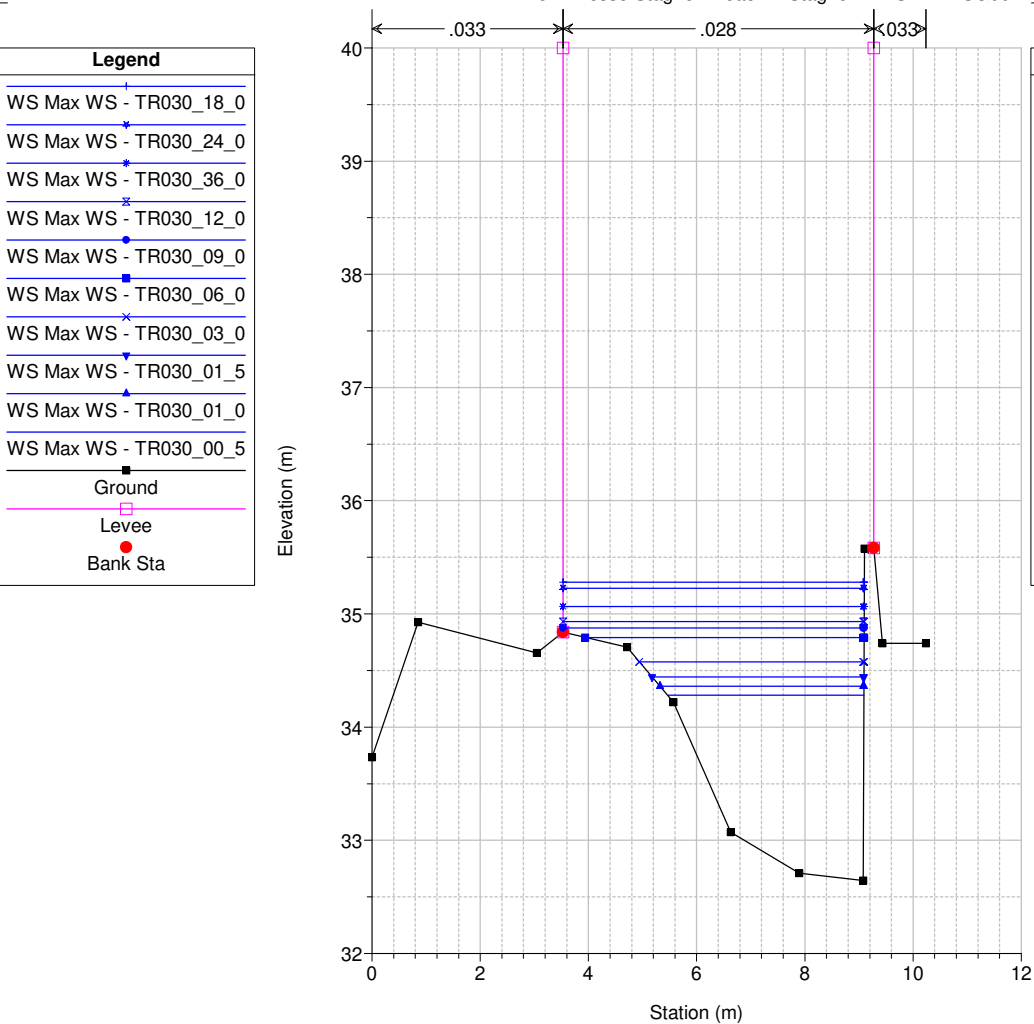

Studio Scandicci Torrenti Greve-Vingone
River = Fosso Stagno Reach = Stagno RS = 10 SG0048_

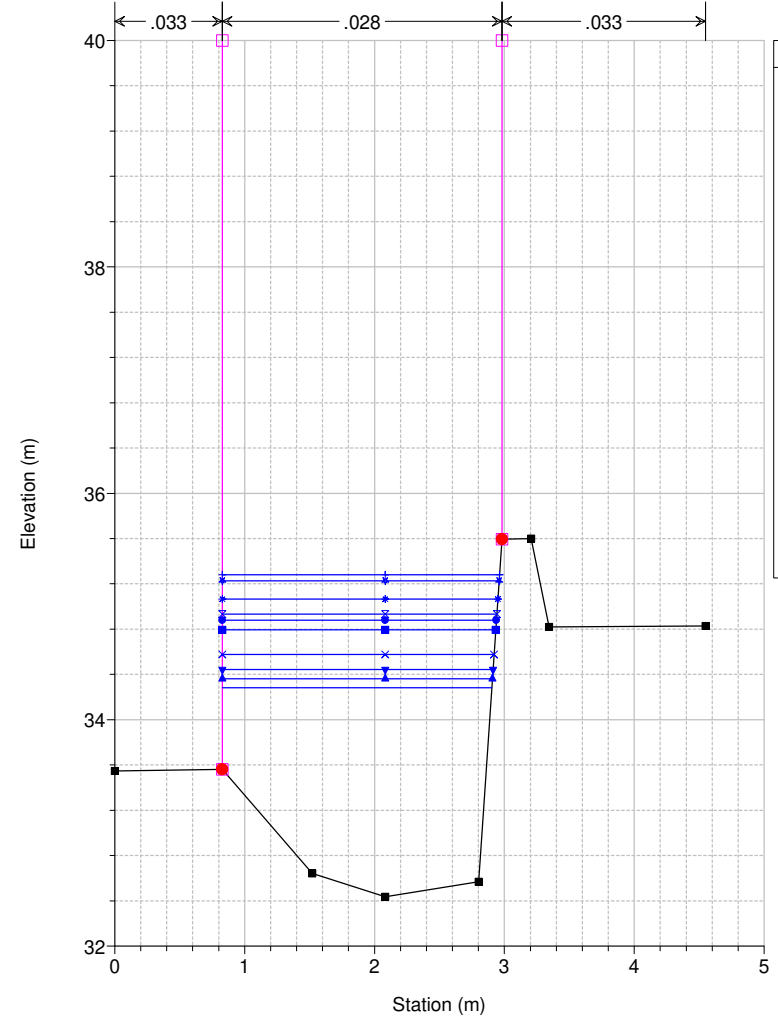

Legend	
WS Max WS - TR030_18_0	+
WS Max WS - TR030_24_0	*
WS Max WS - TR030_36_0	•
WS Max WS - TR030_12_0	•
WS Max WS - TR030_09_0	•
WS Max WS - TR030_06_0	•
WS Max WS - TR030_03_0	x
WS Max WS - TR030_01_5	v
WS Max WS - TR030_01_0	▲
WS Max WS - TR030_00_5	▲
Ground	■
Levee	□
Bank Sta	●

Studio Scandicci Torrenti Greve-Vingone
River = Fosso Stagno Reach = Stagno RS = 9 SG0049_A

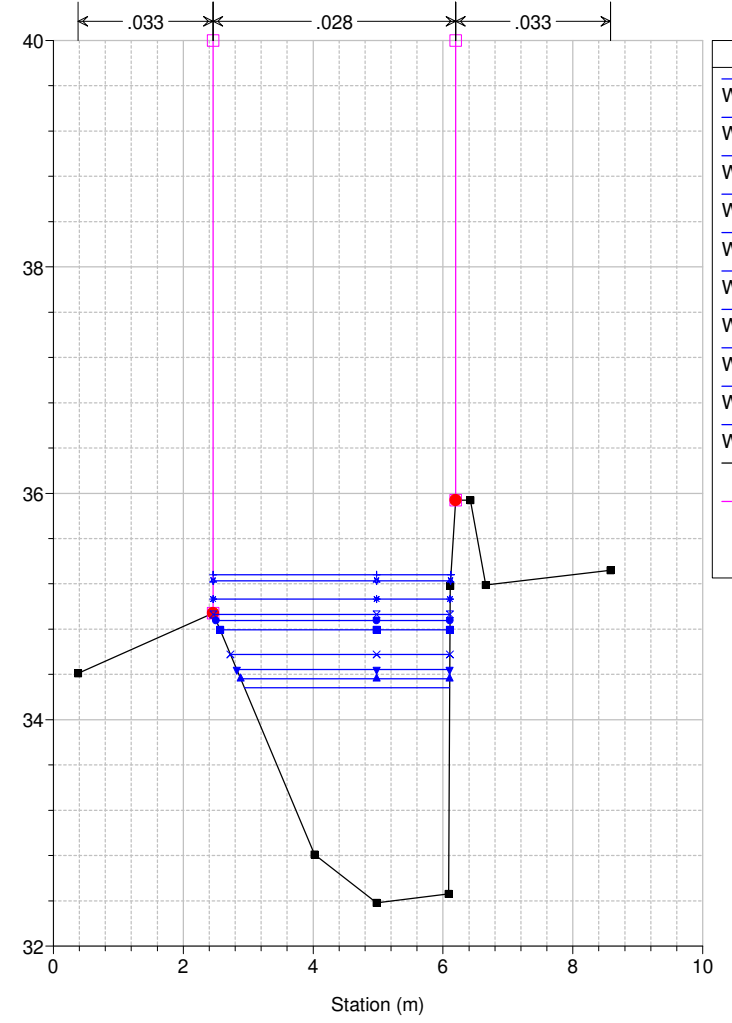

Legend	
WS Max WS - TR030_18_0	+
WS Max WS - TR030_24_0	*
WS Max WS - TR030_36_0	•
WS Max WS - TR030_12_0	•
WS Max WS - TR030_09_0	•
WS Max WS - TR030_06_0	•
WS Max WS - TR030_03_0	x
WS Max WS - TR030_01_5	v
WS Max WS - TR030_01_0	▲
WS Max WS - TR030_00_5	▲
Ground	■
Levee	□
Bank Sta	●

Studio Scandicci Torrenti Greve-Vingone
River = Fosso Stagno Reach = Stagno RS = 8 SG0049_B

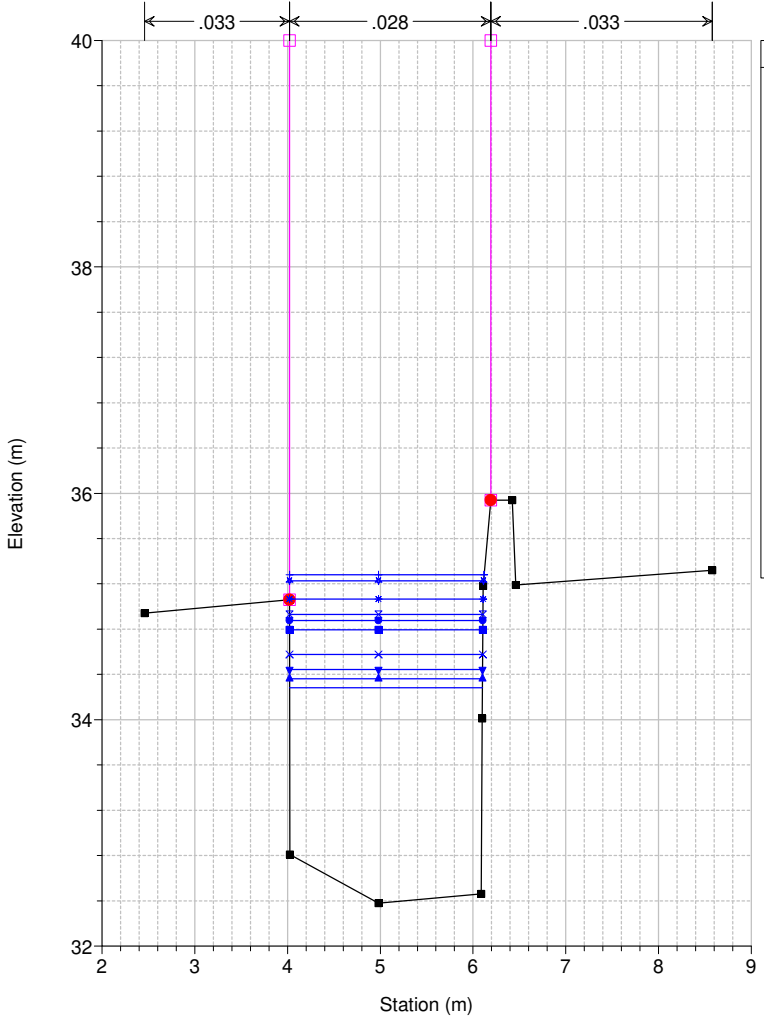

Legend	
WS Max WS - TR030_18_0	+
WS Max WS - TR030_24_0	*
WS Max WS - TR030_36_0	•
WS Max WS - TR030_12_0	•
WS Max WS - TR030_09_0	•
WS Max WS - TR030_06_0	•
WS Max WS - TR030_03_0	x
WS Max WS - TR030_01_5	v
WS Max WS - TR030_01_0	▲
WS Max WS - TR030_00_5	▲
Ground	■
Levee	□
Bank Sta	●

Studio Scandicci Torrenti Greve-Vingone
River = Fosso Stagno Reach = Stagno RS = 7.5 BR

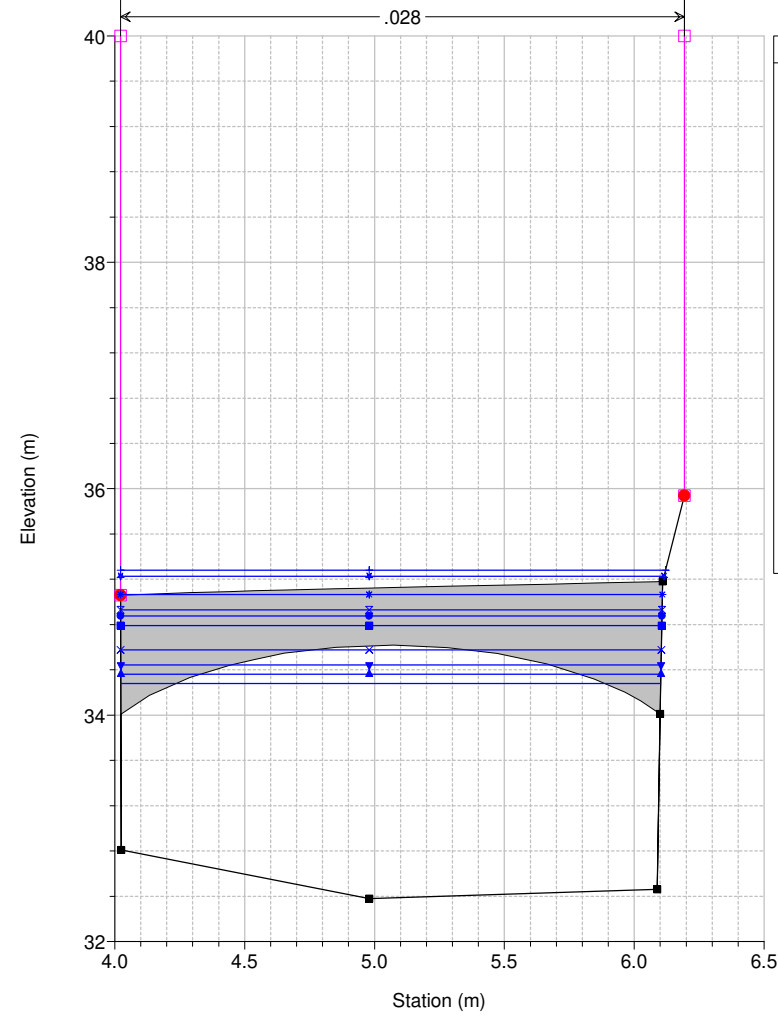

Legend	
WS Max WS - TR030_18_0	+
WS Max WS - TR030_24_0	*
WS Max WS - TR030_36_0	•
WS Max WS - TR030_12_0	•
WS Max WS - TR030_09_0	•
WS Max WS - TR030_06_0	•
WS Max WS - TR030_03_0	x
WS Max WS - TR030_01_5	v
WS Max WS - TR030_01_0	▲
WS Max WS - TR030_00_5	▲
Ground	■
Levee	□
Bank Sta	●

Studio Scandicci Torrenti Greve-Vingone
River = Fosso Stagno Reach = Stagno RS = 7.5 BR

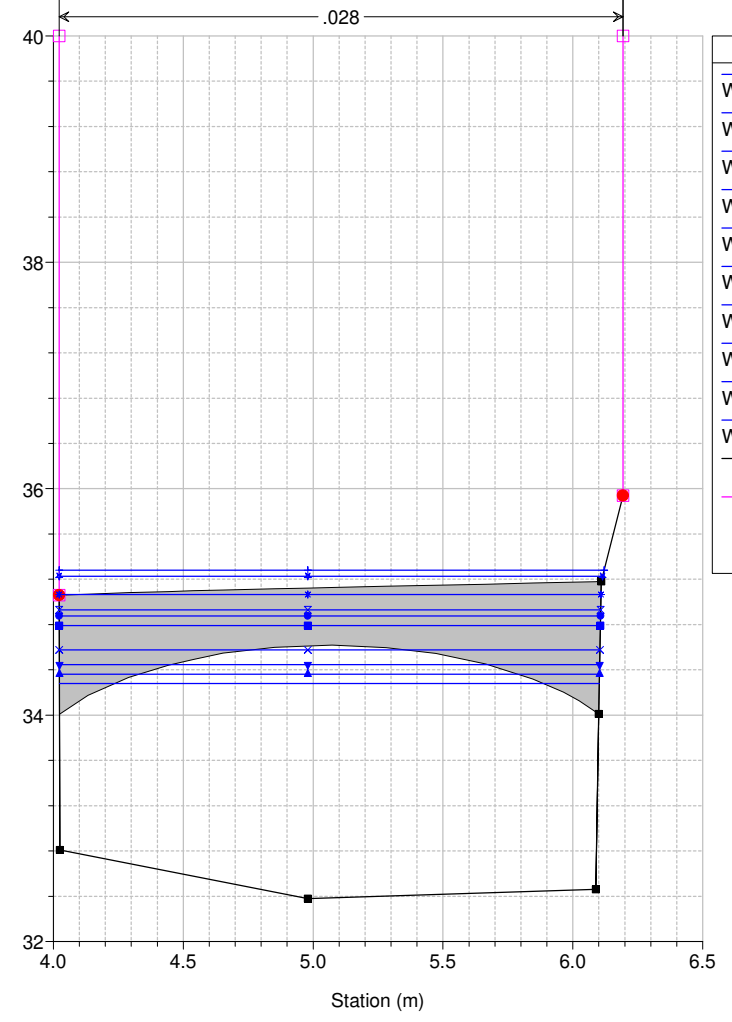

Legend	
WS Max WS - TR030_18_0	+
WS Max WS - TR030_24_0	*
WS Max WS - TR030_36_0	•
WS Max WS - TR030_12_0	•
WS Max WS - TR030_09_0	•
WS Max WS - TR030_06_0	•
WS Max WS - TR030_03_0	x
WS Max WS - TR030_01_5	v
WS Max WS - TR030_01_0	▲
WS Max WS - TR030_00_5	▲
Ground	■
Levee	□
Bank Sta	●

Studio Scandicci Torrenti Greve-Vingone
River = Fosso Stagno Reach = Stagno RS = 7 SG0049_C

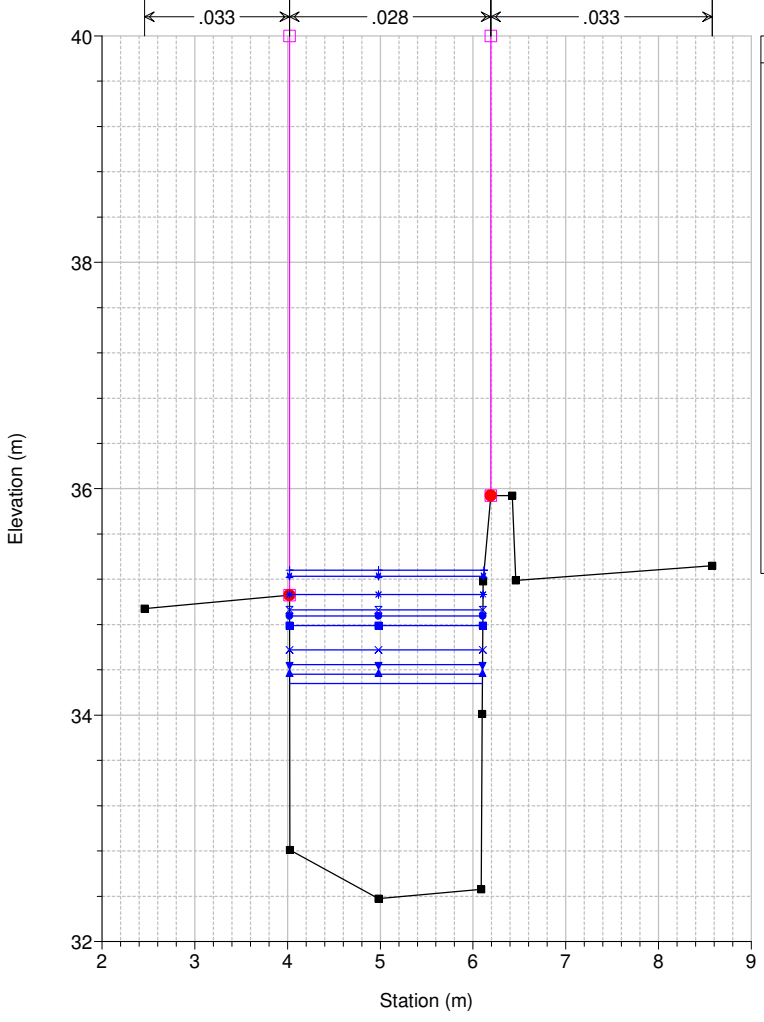

Legend	
WS Max WS - TR030_18_0	+
WS Max WS - TR030_24_0	*
WS Max WS - TR030_36_0	•
WS Max WS - TR030_12_0	•
WS Max WS - TR030_09_0	•
WS Max WS - TR030_06_0	•
WS Max WS - TR030_03_0	x
WS Max WS - TR030_01_5	v
WS Max WS - TR030_01_0	▲
WS Max WS - TR030_00_5	▲
Ground	■
Levee	□
Bank Sta	●

Studio Scandicci Torrenti Greve-Vingone
River = Fosso Stagno Reach = Stagno RS = 6 SG0049_D

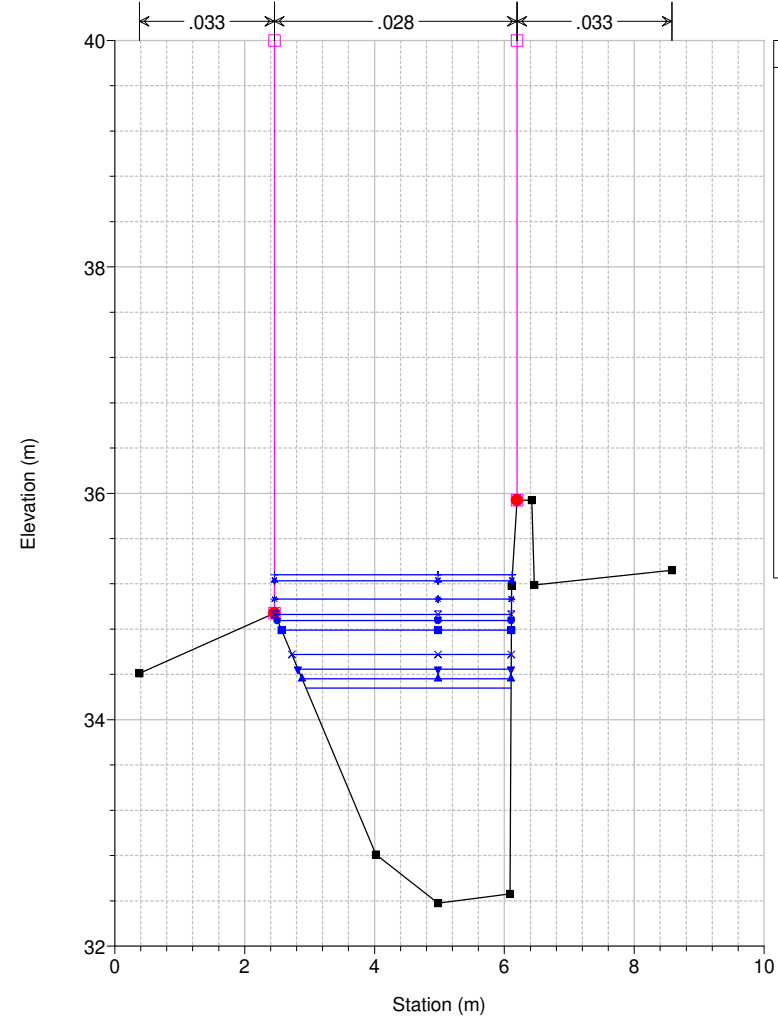

Legend	
WS Max WS - TR030_18_0	+
WS Max WS - TR030_24_0	*
WS Max WS - TR030_36_0	•
WS Max WS - TR030_12_0	x
WS Max WS - TR030_09_0	•
WS Max WS - TR030_06_0	■
WS Max WS - TR030_03_0	x
WS Max WS - TR030_01_5	▼
WS Max WS - TR030_01_0	▲
WS Max WS - TR030_00_5	■
Ground	—
Levee	—
Bank Sta	•

Studio Scandicci Torrenti Greve-Vingone
River = Fosso Stagno Reach = Stagno RS = 5 SG0050_

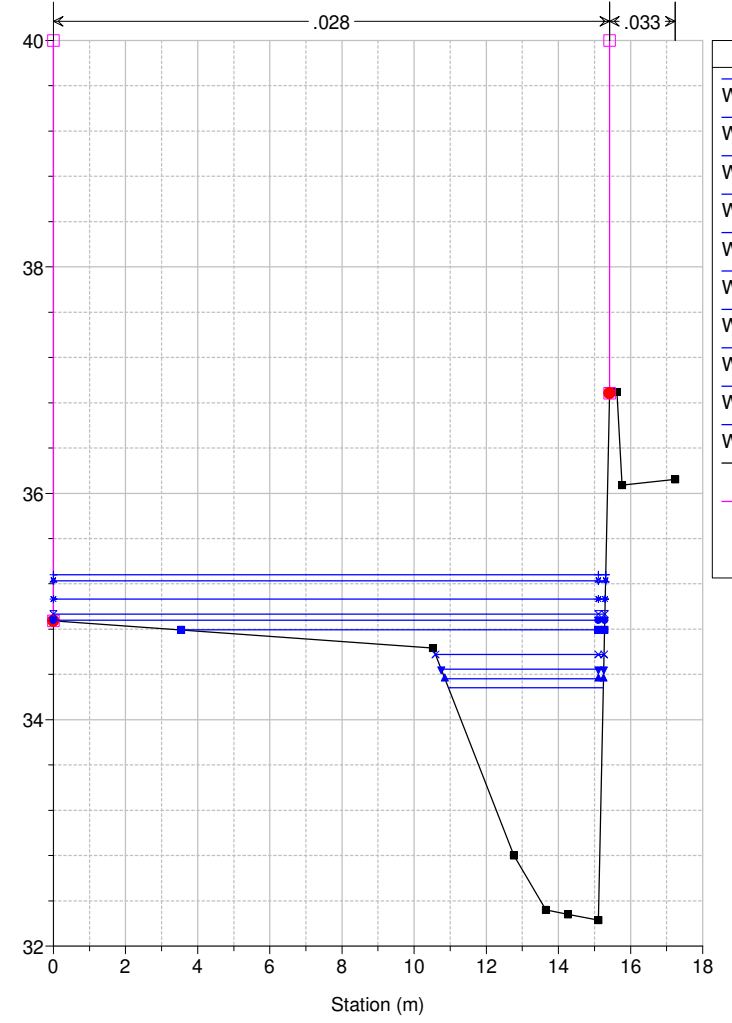

Legend	
WS Max WS - TR030_18_0	+
WS Max WS - TR030_24_0	*
WS Max WS - TR030_36_0	•
WS Max WS - TR030_12_0	x
WS Max WS - TR030_09_0	•
WS Max WS - TR030_06_0	■
WS Max WS - TR030_03_0	x
WS Max WS - TR030_01_5	▼
WS Max WS - TR030_01_0	▲
WS Max WS - TR030_00_5	■
Ground	—
Levee	—
Bank Sta	•

Studio Scandicci Torrenti Greve-Vingone
River = Fosso Stagno Reach = Stagno RS = 4 SG0051_

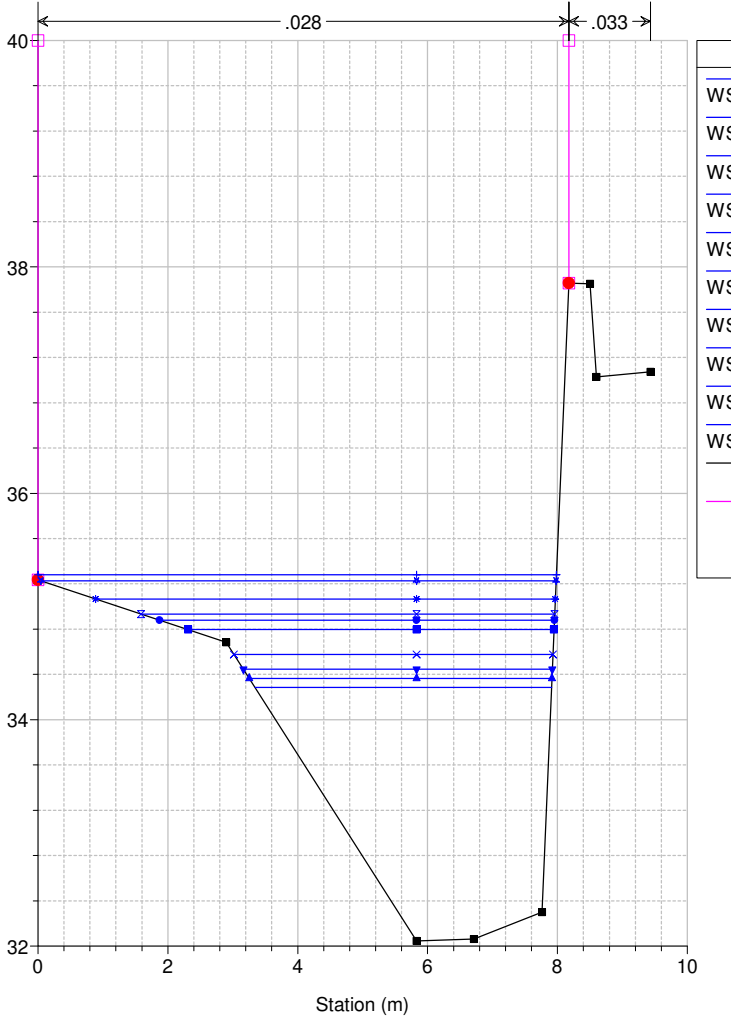

Legend	
WS Max WS - TR030_18_0	+
WS Max WS - TR030_24_0	*
WS Max WS - TR030_36_0	•
WS Max WS - TR030_12_0	x
WS Max WS - TR030_09_0	•
WS Max WS - TR030_06_0	■
WS Max WS - TR030_03_0	x
WS Max WS - TR030_01_5	▼
WS Max WS - TR030_01_0	▲
WS Max WS - TR030_00_5	■
Ground	—
Levee	—
Bank Sta	•

Studio Scandicci Torrenti Greve-Vingone
River = Fosso Stagno Reach = Stagno RS = 3 SG0052_A

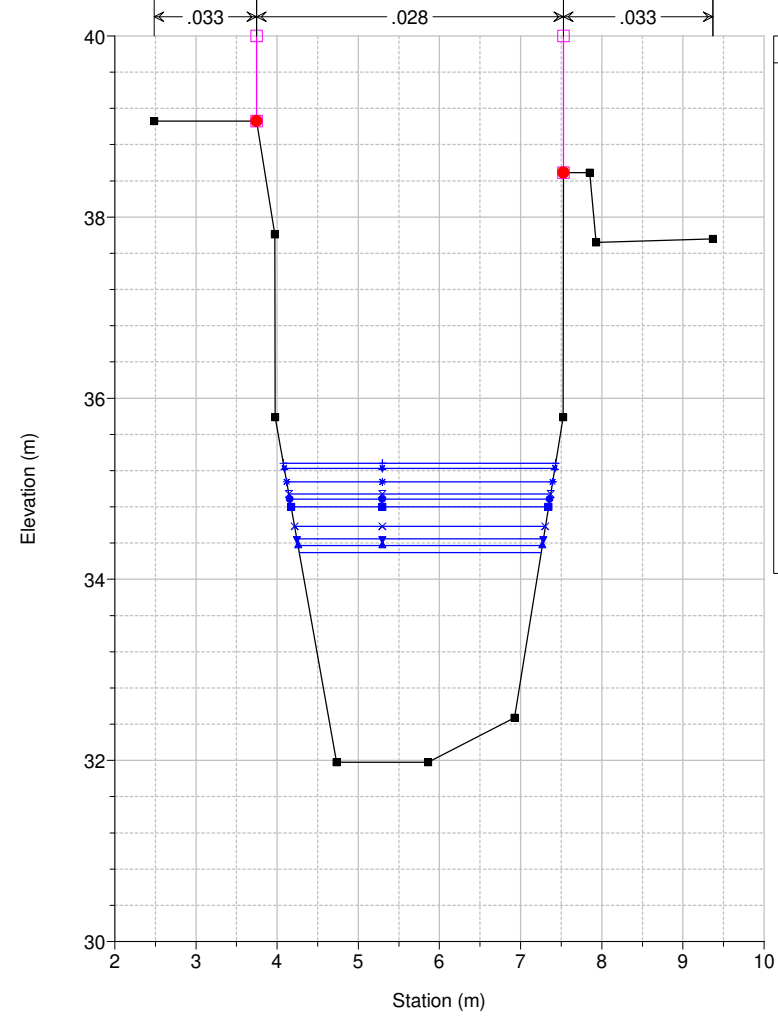

Legend	
WS Max WS - TR030_18_0	+
WS Max WS - TR030_24_0	*
WS Max WS - TR030_36_0	•
WS Max WS - TR030_12_0	x
WS Max WS - TR030_09_0	•
WS Max WS - TR030_06_0	■
WS Max WS - TR030_03_0	x
WS Max WS - TR030_01_5	▼
WS Max WS - TR030_01_0	▲
WS Max WS - TR030_00_5	■
Ground	—
Levee	—
Bank Sta	•

Studio Scandicci Torrenti Greve-Vingone
River = Fosso Stagno Reach = Stagno RS = 2 SG0052_B

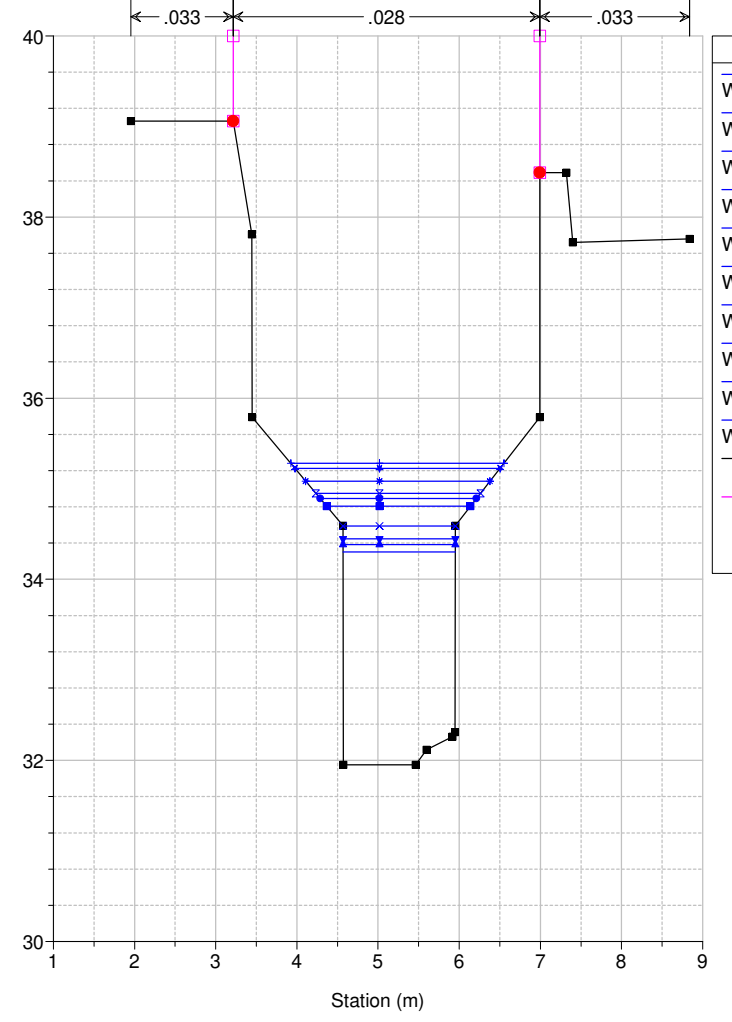

Legend	
WS Max WS - TR030_18_0	+
WS Max WS - TR030_24_0	*
WS Max WS - TR030_36_0	•
WS Max WS - TR030_12_0	x
WS Max WS - TR030_09_0	•
WS Max WS - TR030_06_0	■
WS Max WS - TR030_03_0	x
WS Max WS - TR030_01_5	▼
WS Max WS - TR030_01_0	▲
WS Max WS - TR030_00_5	■
Ground	—
Levee	—
Bank Sta	•

Studio Scandicci Torrenti Greve-Vingone
River = Fosso Stagno Reach = Stagno RS = 1.5 IS

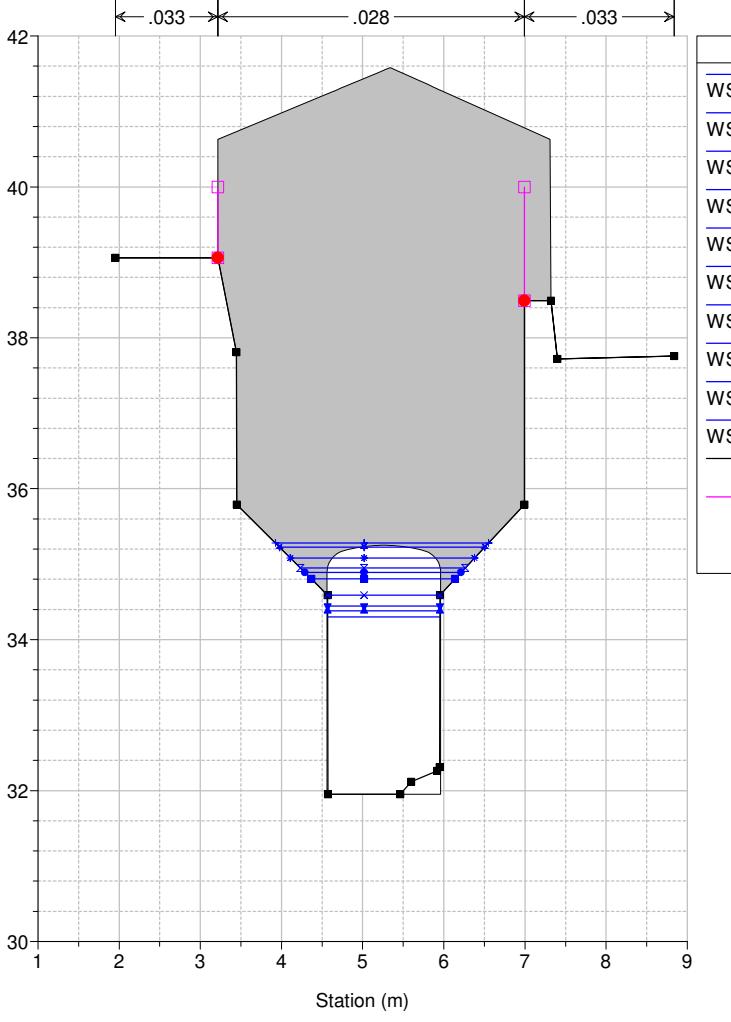

Legend	
WS Max WS - TR030_18_0	+
WS Max WS - TR030_24_0	*
WS Max WS - TR030_36_0	•
WS Max WS - TR030_12_0	x
WS Max WS - TR030_09_0	•
WS Max WS - TR030_06_0	■
WS Max WS - TR030_03_0	x
WS Max WS - TR030_01_5	▼
WS Max WS - TR030_01_0	▲
WS Max WS - TR030_00_5	■
Ground	—
Levee	—
Bank Sta	•

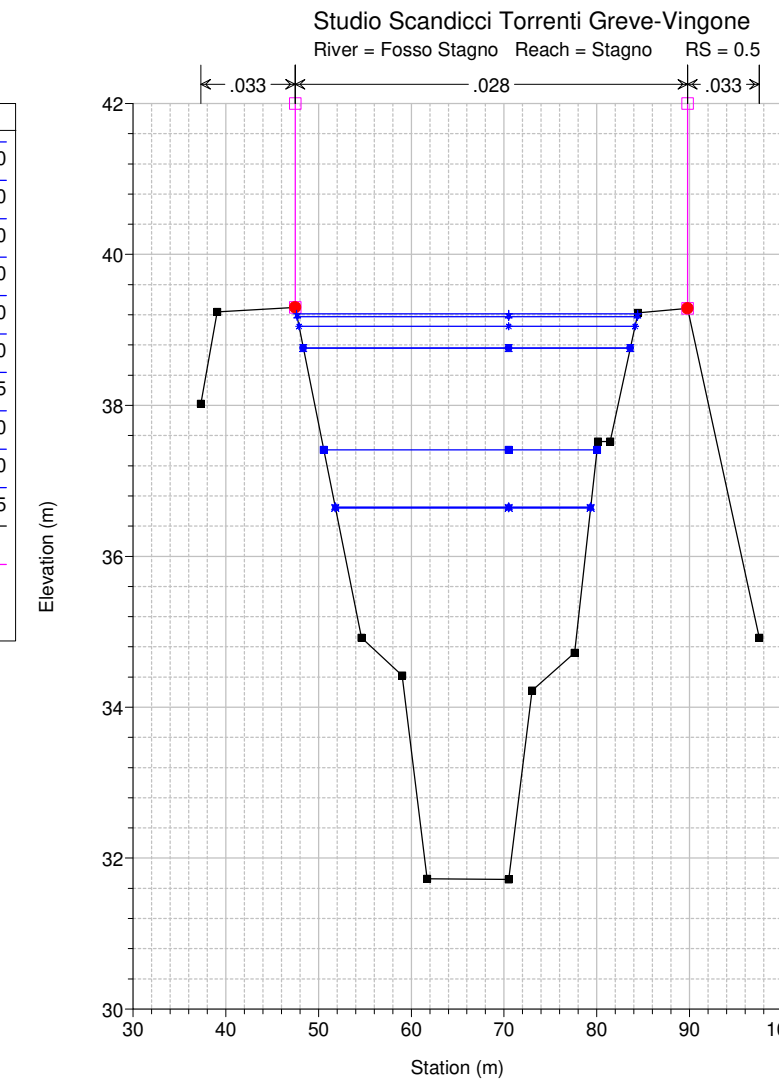
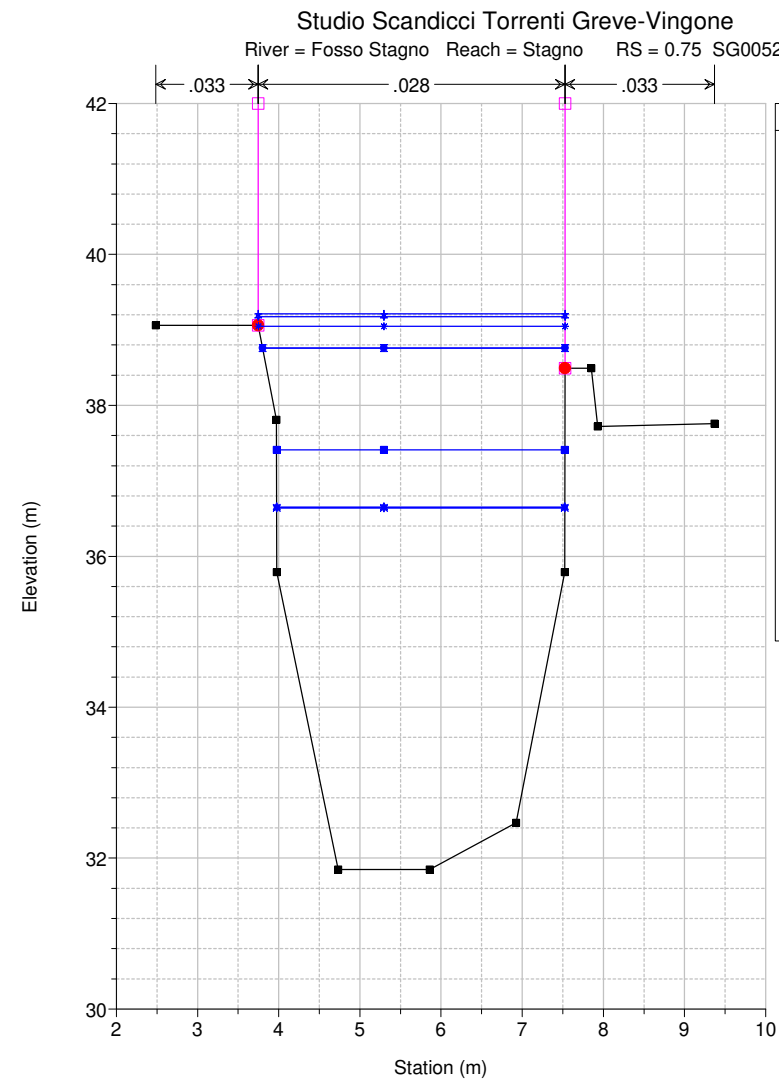
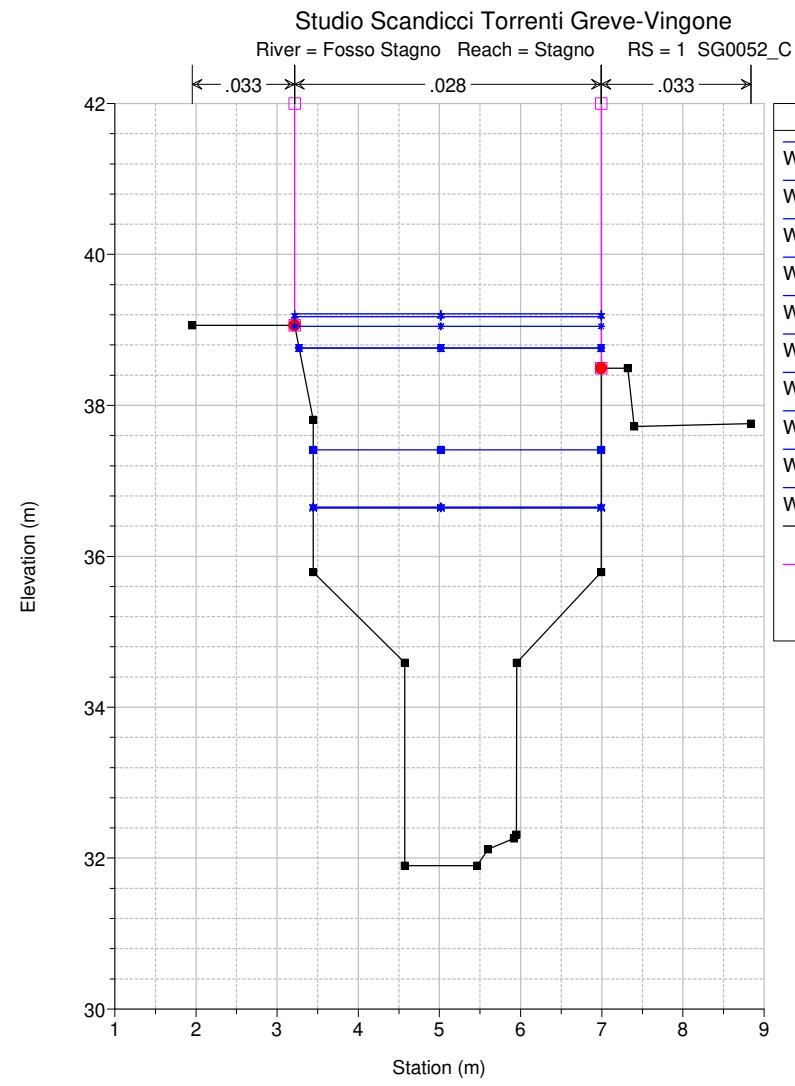

Studio Scandicci Torrenti Greve-Vingone
River = Fosso Stagnolo Reach = Stagnolo RS = 107 ST0001_D

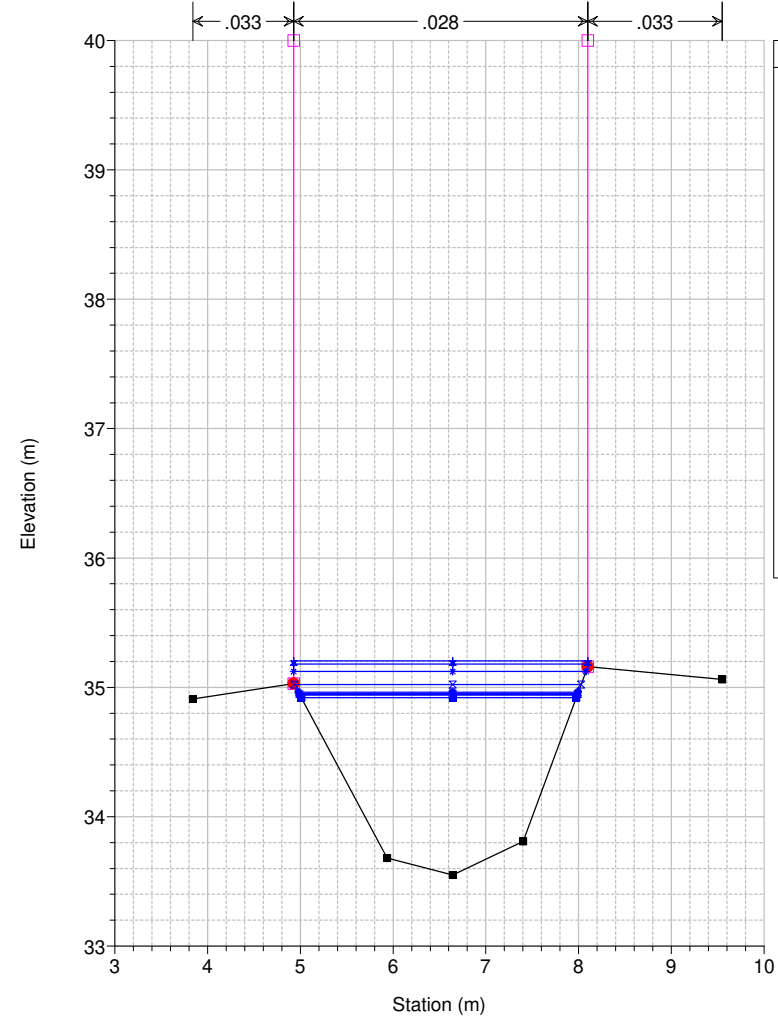

Legend

- WS Max WS - TR030_18_0
- WS Max WS - TR030_24_0
- WS Max WS - TR030_36_0
- WS Max WS - TR030_12_0
- WS Max WS - TR030_09_0
- WS Max WS - TR030_01_0
- WS Max WS - TR030_03_0
- WS Max WS - TR030_01_5
- WS Max WS - TR030_00_5
- WS Max WS - TR030_06_0
- Ground
- Levee
- Bank Sta

Studio Scandicci Torrenti Greve-Vingone
River = Fosso Stagnolo Reach = Stagnolo RS = 106 ST0002_

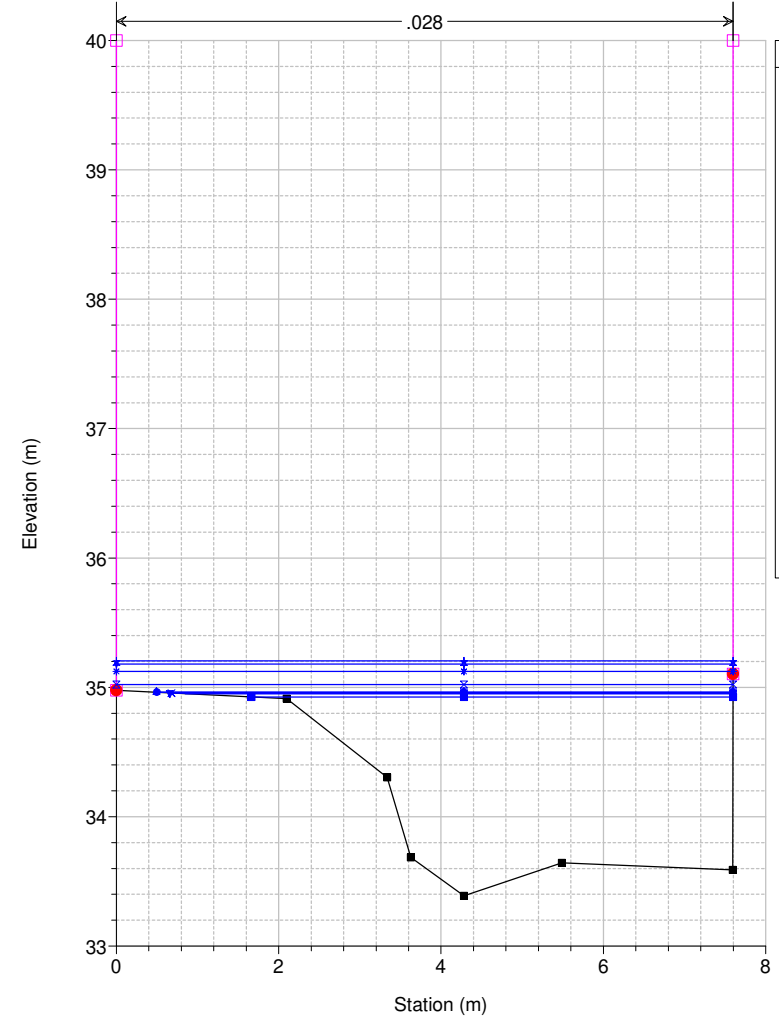

Legend

- WS Max WS - TR030_18_0
- WS Max WS - TR030_24_0
- WS Max WS - TR030_36_0
- WS Max WS - TR030_12_0
- WS Max WS - TR030_09_0
- WS Max WS - TR030_01_0
- WS Max WS - TR030_09_0
- WS Max WS - TR030_01_5
- WS Max WS - TR030_03_0
- WS Max WS - TR030_00_5
- WS Max WS - TR030_06_0
- Ground
- Levee
- Bank Sta

Studio Scandicci Torrenti Greve-Vingone
River = Fosso Stagnolo Reach = Stagnolo RS = 105 ST0003_

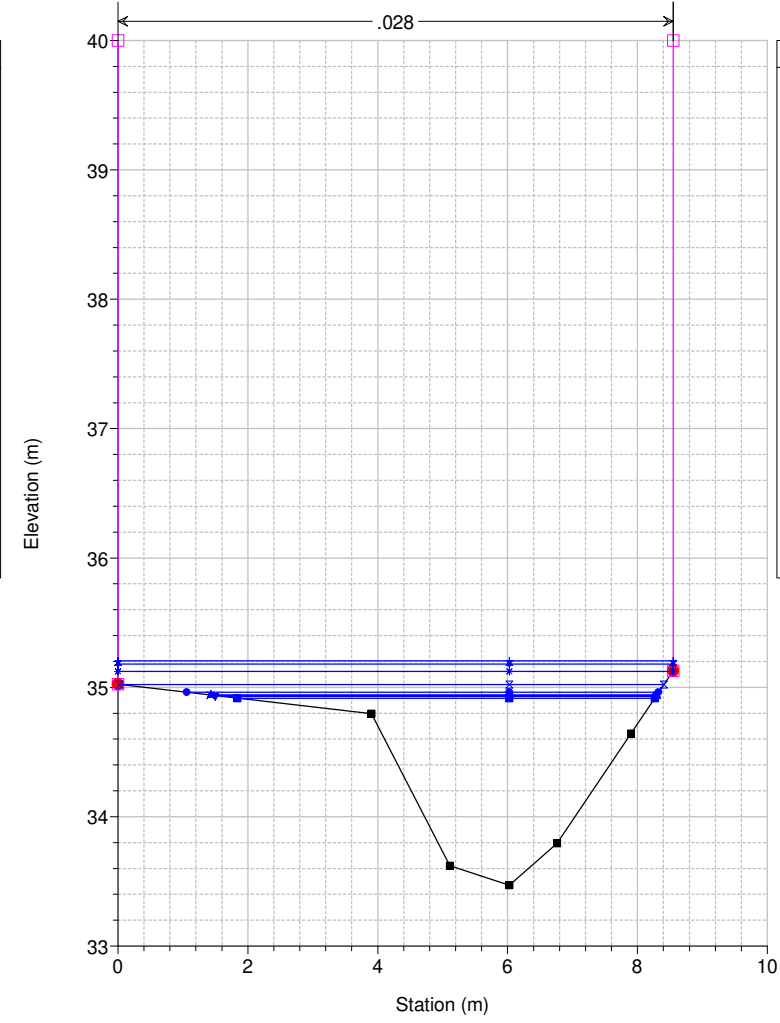

Legend

- WS Max WS - TR030_18_0
- WS Max WS - TR030_24_0
- WS Max WS - TR030_36_0
- WS Max WS - TR030_12_0
- WS Max WS - TR030_09_0
- WS Max WS - TR030_01_0
- WS Max WS - TR030_03_0
- WS Max WS - TR030_01_5
- WS Max WS - TR030_00_5
- WS Max WS - TR030_06_0
- Ground
- Levee
- Bank Sta

Studio Scandicci Torrenti Greve-Vingone
River = Fosso Stagnolo Reach = Stagnolo RS = 104 ST0004_A

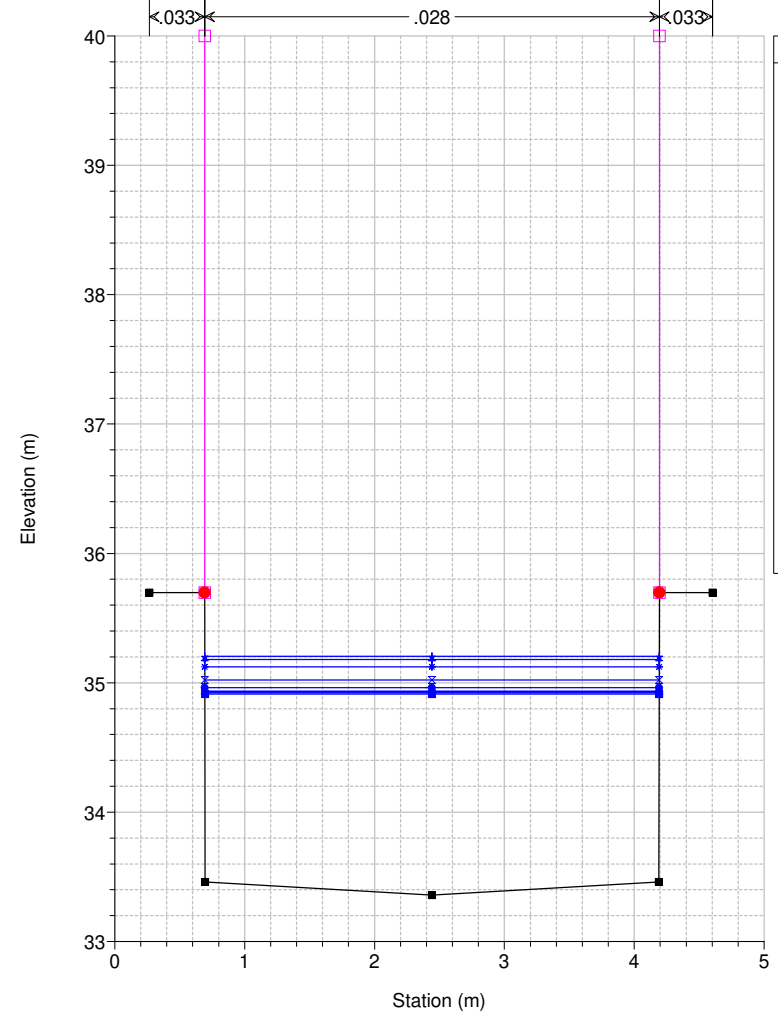

Legend

- WS Max WS - TR030_18_0
- WS Max WS - TR030_24_0
- WS Max WS - TR030_36_0
- WS Max WS - TR030_12_0
- WS Max WS - TR030_09_0
- WS Max WS - TR030_03_0
- WS Max WS - TR030_01_0
- WS Max WS - TR030_01_5
- WS Max WS - TR030_00_5
- WS Max WS - TR030_06_0
- Ground
- Levee
- Bank Sta

Studio Scandicci Torrenti Greve-Vingone
River = Fosso Stagnolo Reach = Stagnolo RS = 103 ST0004_B

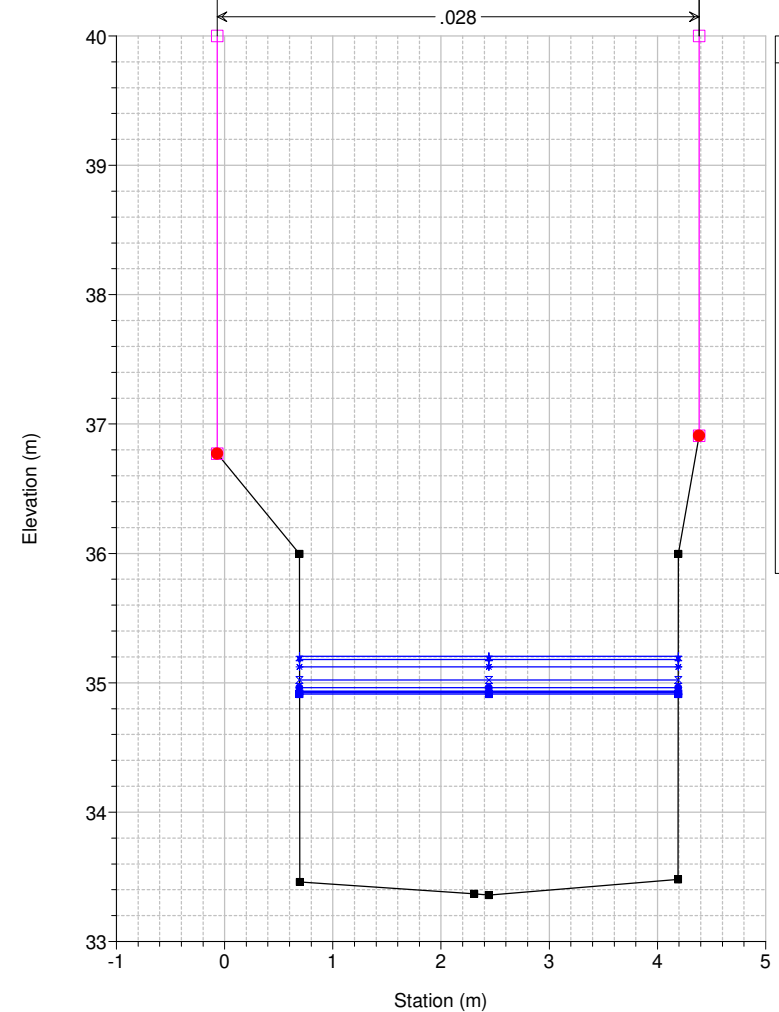

Legend

- WS Max WS - TR030_18_0
- WS Max WS - TR030_24_0
- WS Max WS - TR030_36_0
- WS Max WS - TR030_12_0
- WS Max WS - TR030_09_0
- WS Max WS - TR030_03_0
- WS Max WS - TR030_01_0
- WS Max WS - TR030_01_5
- WS Max WS - TR030_00_5
- WS Max WS - TR030_06_0
- Ground
- Levee
- Bank Sta

Studio Scandicci Torrenti Greve-Vingone
River = Fosso Stagnolo Reach = Stagnolo RS = 102.5 BR

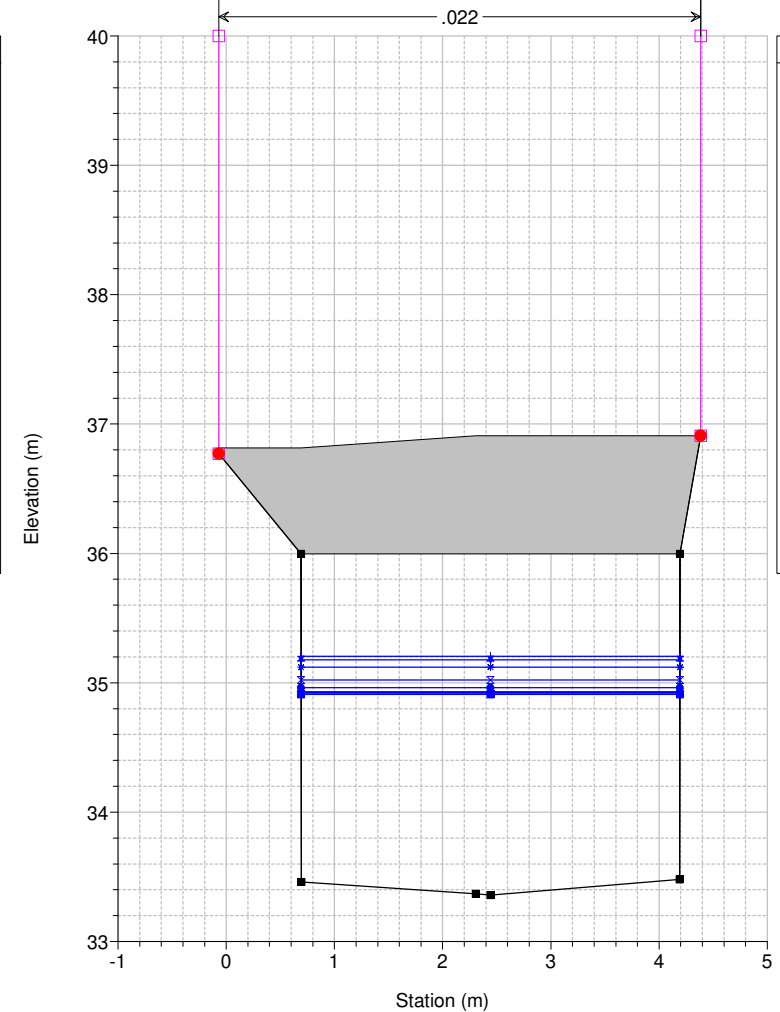

Legend

- WS Max WS - TR030_18_0
- WS Max WS - TR030_24_0
- WS Max WS - TR030_36_0
- WS Max WS - TR030_12_0
- WS Max WS - TR030_09_0
- WS Max WS - TR030_03_0
- WS Max WS - TR030_01_0
- WS Max WS - TR030_01_5
- WS Max WS - TR030_00_5
- WS Max WS - TR030_06_0
- Ground
- Levee
- Bank Sta

Studio Scandicci Torrenti Greve-Vingone
River = Fosso Stagnolo Reach = Stagnolo RS = 102.5 BR

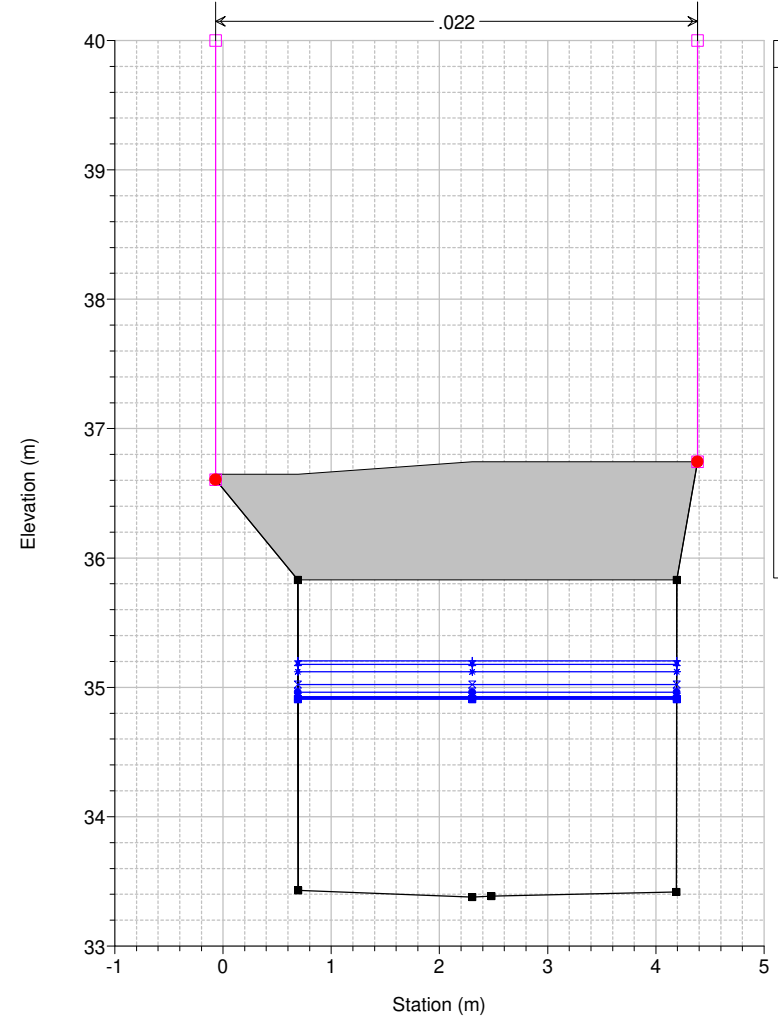

Legend

- WS Max WS - TR030_18_0
- WS Max WS - TR030_24_0
- WS Max WS - TR030_36_0
- WS Max WS - TR030_12_0
- WS Max WS - TR030_09_0
- WS Max WS - TR030_03_0
- WS Max WS - TR030_01_0
- WS Max WS - TR030_01_5
- WS Max WS - TR030_00_5
- WS Max WS - TR030_06_0
- Ground
- Levee
- Bank Sta

Studio Scandicci Torrenti Greve-Vingone
River = Fosso Stagnolo Reach = Stagnolo RS = 102 ST0004_C

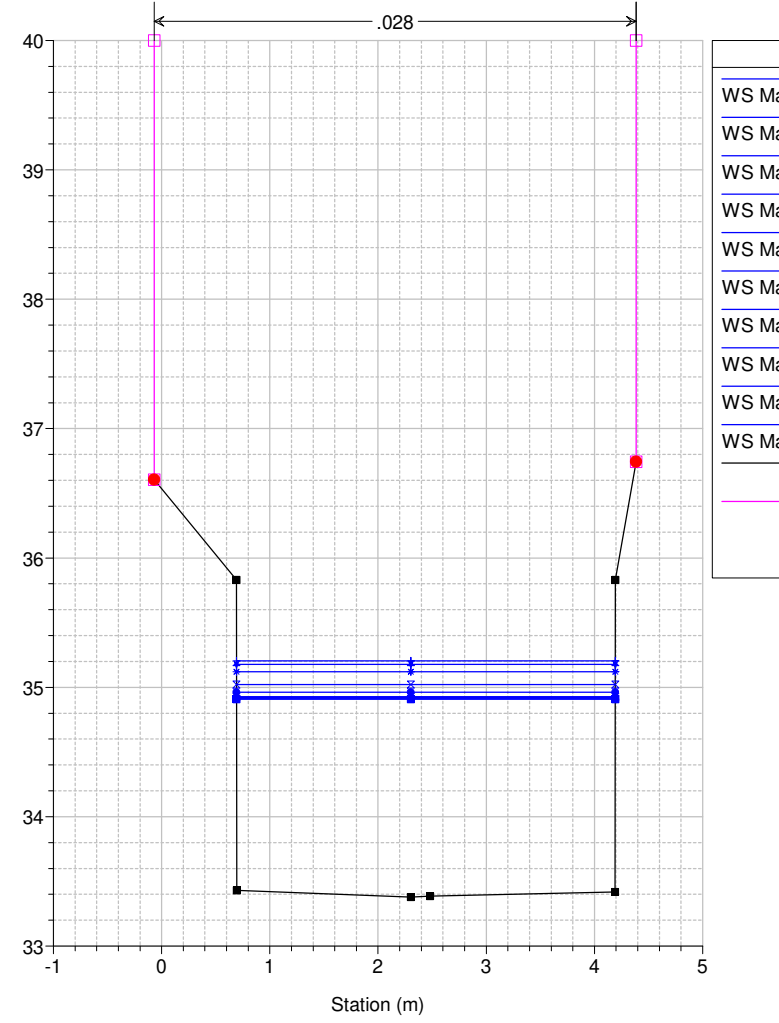

Legend

- WS Max WS - TR030_18_0
- WS Max WS - TR030_24_0
- WS Max WS - TR030_36_0
- WS Max WS - TR030_12_0
- WS Max WS - TR030_09_0
- WS Max WS - TR030_03_0
- WS Max WS - TR030_01_0
- WS Max WS - TR030_01_5
- WS Max WS - TR030_00_5
- WS Max WS - TR030_06_0
- Ground
- Levee
- Bank Sta

Studio Scandicci Torrenti Greve-Vingone
River = Fosso Stagnolo Reach = Stagnolo RS = 101 ST0004_D

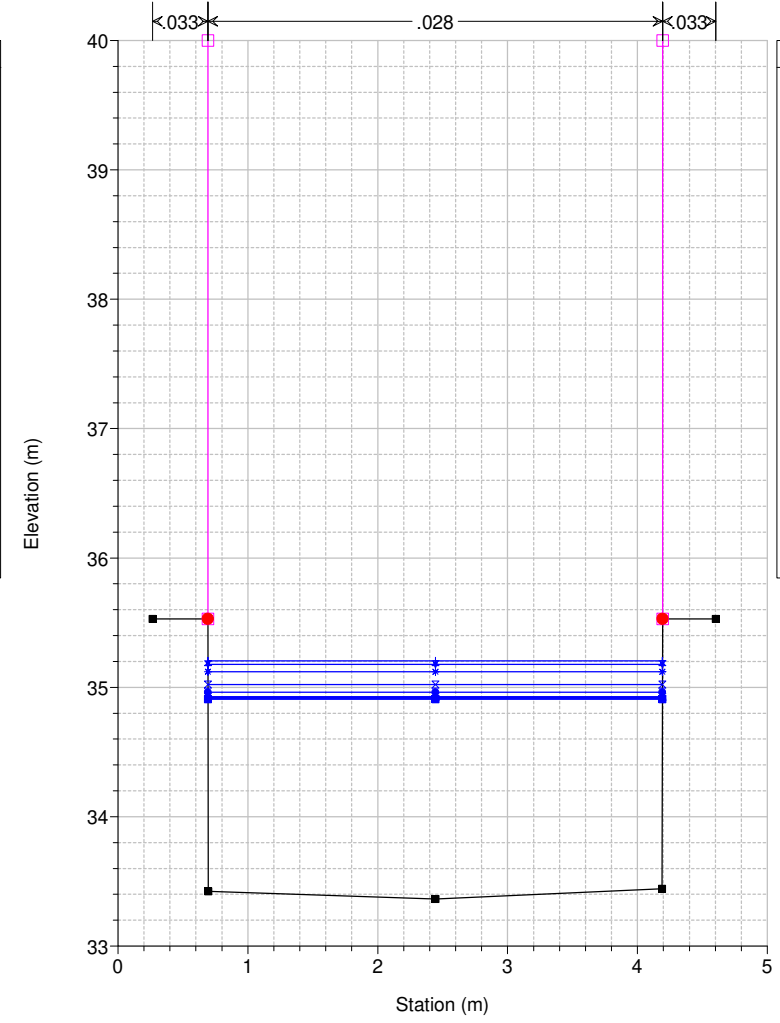

Legend

- WS Max WS - TR030_18_0
- WS Max WS - TR030_24_0
- WS Max WS - TR030_36_0
- WS Max WS - TR030_12_0
- WS Max WS - TR030_09_0
- WS Max WS - TR030_03_0
- WS Max WS - TR030_01_0
- WS Max WS - TR030_01_5
- WS Max WS - TR030_00_5
- WS Max WS - TR030_06_0
- Ground
- Levee
- Bank Sta

Studio Scandicci Torrenti Greve-Vingone
River = Fosso Stagnolo Reach = Stagnolo RS = 100 ST0005_A

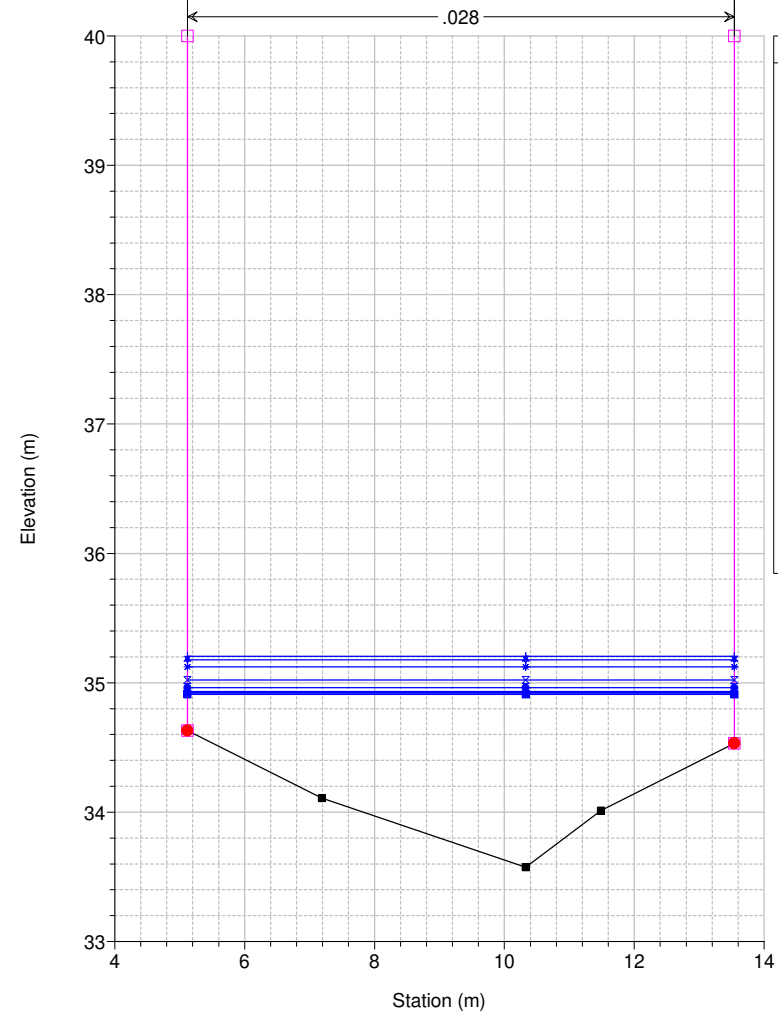

Legend

- WS Max WS - TR030_18_0
- WS Max WS - TR030_24_0
- WS Max WS - TR030_36_0
- WS Max WS - TR030_12_0
- WS Max WS - TR030_09_0
- WS Max WS - TR030_03_0
- WS Max WS - TR030_01_0
- WS Max WS - TR030_01_5
- WS Max WS - TR030_00_5
- WS Max WS - TR030_06_0
- Ground
- Levee
- Bank Sta

Studio Scandicci Torrenti Greve-Vingone
River = Fosso Stagnolo Reach = Stagnolo RS = 99 ST0005_B

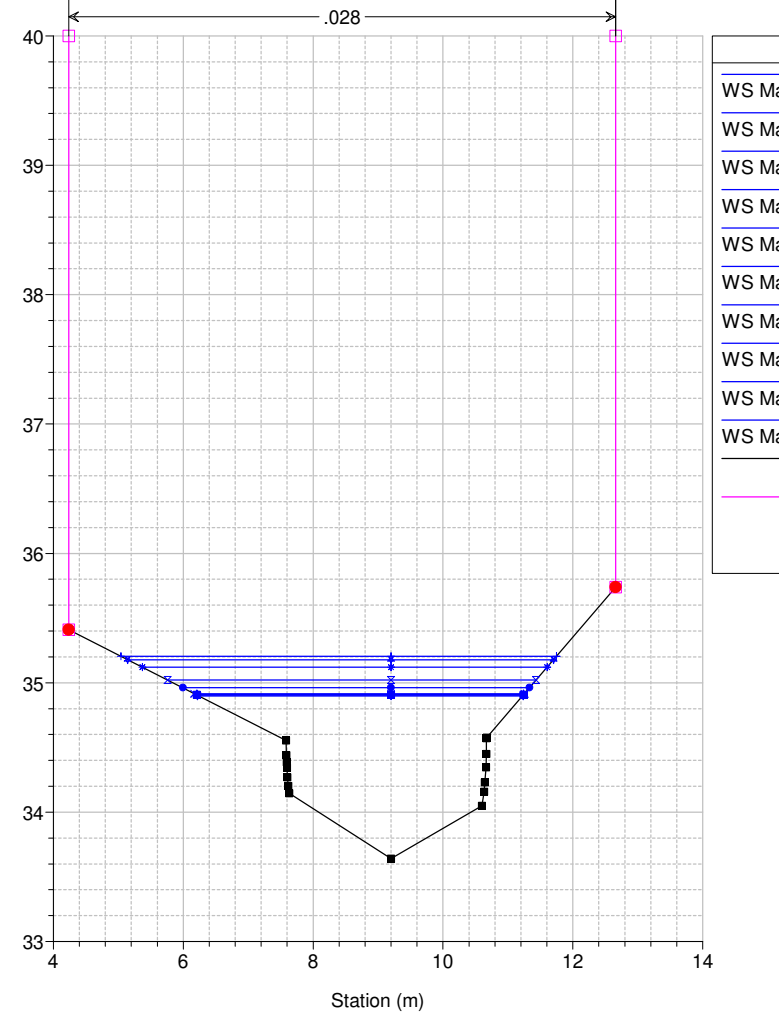

Legend

- WS Max WS - TR030_18_0
- WS Max WS - TR030_24_0
- WS Max WS - TR030_36_0
- WS Max WS - TR030_12_0
- WS Max WS - TR030_09_0
- WS Max WS - TR030_03_0
- WS Max WS - TR030_06_0
- WS Max WS - TR030_01_0
- WS Max WS - TR030_01_5
- WS Max WS - TR030_00_5
- Ground
- Levee
- Bank Sta

Studio Scandicci Torrenti Greve-Vingone
River = Fosso Stagnolo Reach = Stagnolo RS = 98.5 BR

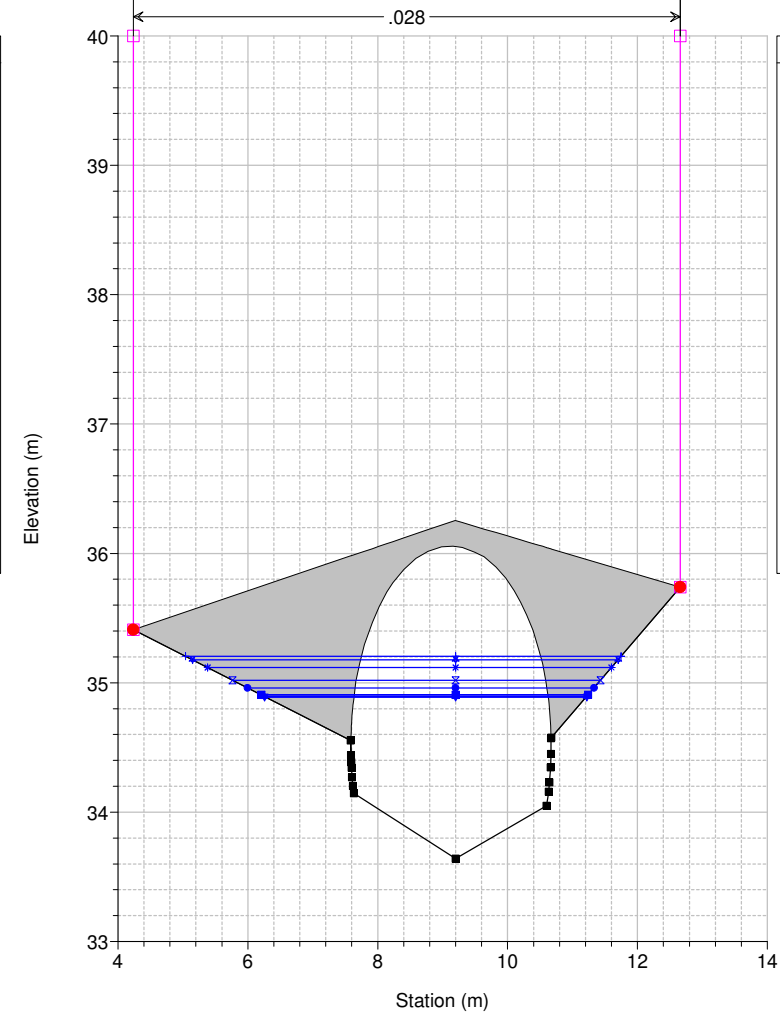

Legend

- WS Max WS - TR030_18_0
- WS Max WS - TR030_24_0
- WS Max WS - TR030_36_0
- WS Max WS - TR030_12_0
- WS Max WS - TR030_09_0
- WS Max WS - TR030_03_0
- WS Max WS - TR030_06_0
- WS Max WS - TR030_01_0
- WS Max WS - TR030_01_5
- WS Max WS - TR030_00_5
- Ground
- Levee
- Bank Sta

Studio Scandicci Torrenti Greve-Vingone
River = Fosso Stagnolo Reach = Stagnolo RS = 98.5 BR

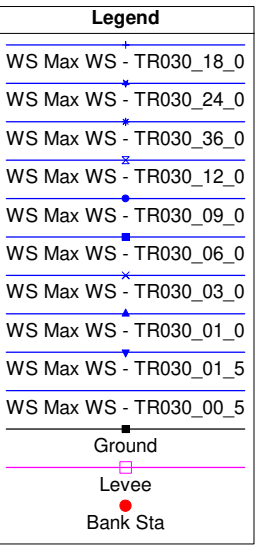
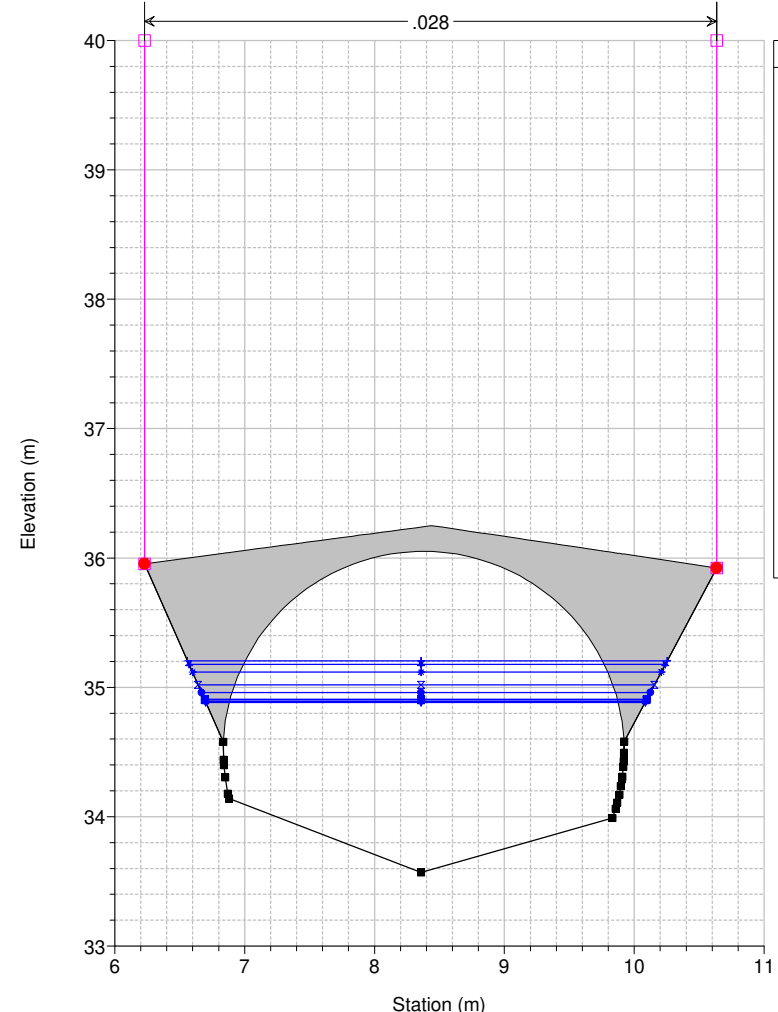

Studio Scandicci Torrenti Greve-Vingone
River = Fosso Stagnolo Reach = Stagnolo RS = 98 ST0005_C

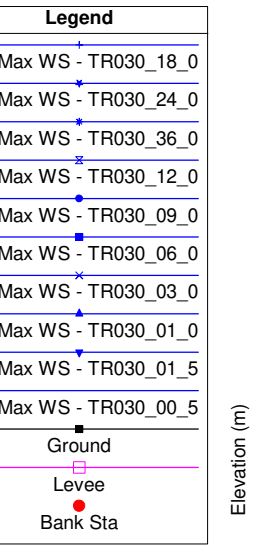
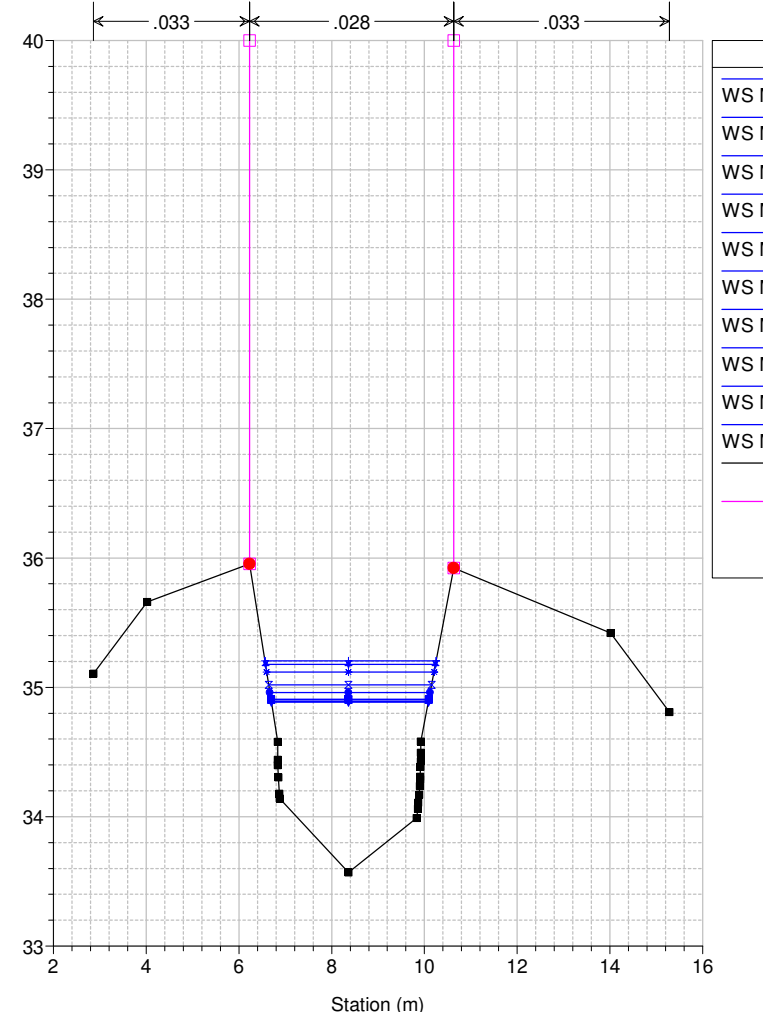

Studio Scandicci Torrenti Greve-Vingone
River = Fosso Stagnolo Reach = Stagnolo RS = 97 ST0005_D

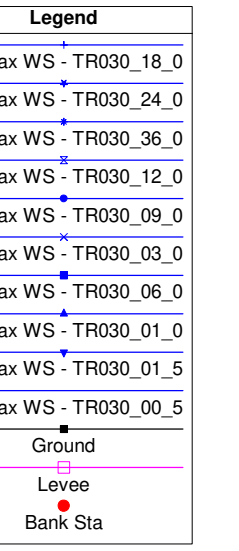
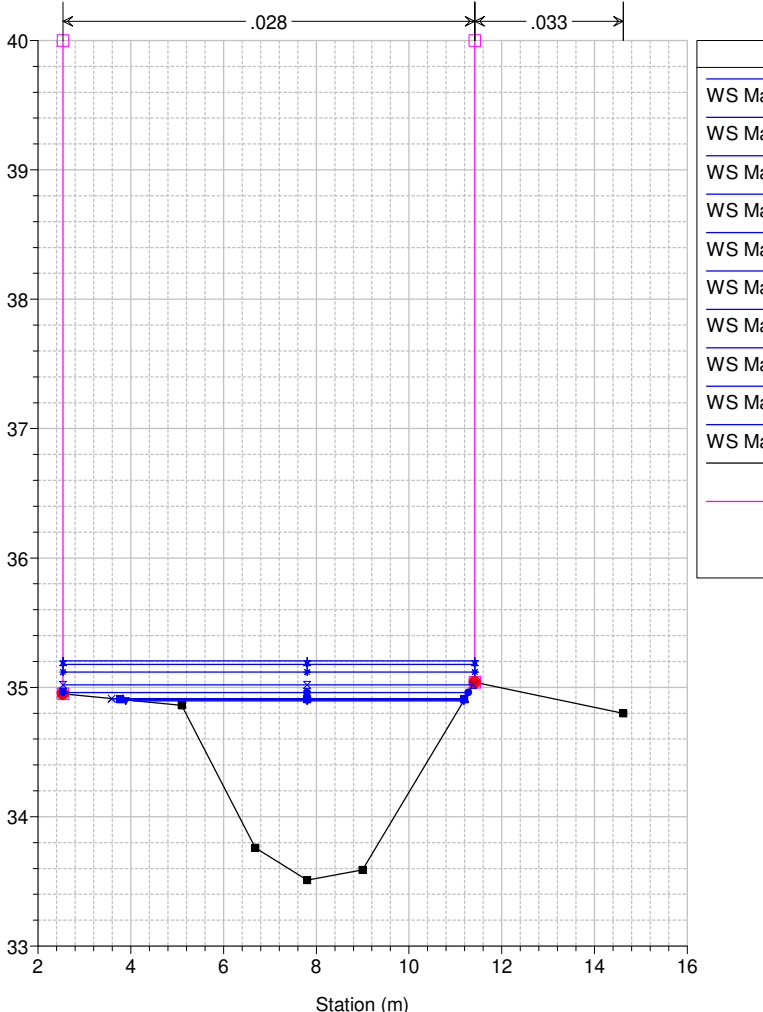

Studio Scandicci Torrenti Greve-Vingone
River = Fosso Stagnolo Reach = Stagnolo RS = 96 ST0006_

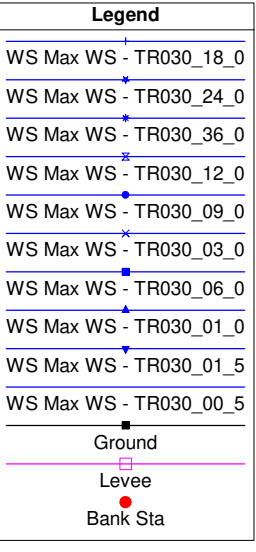
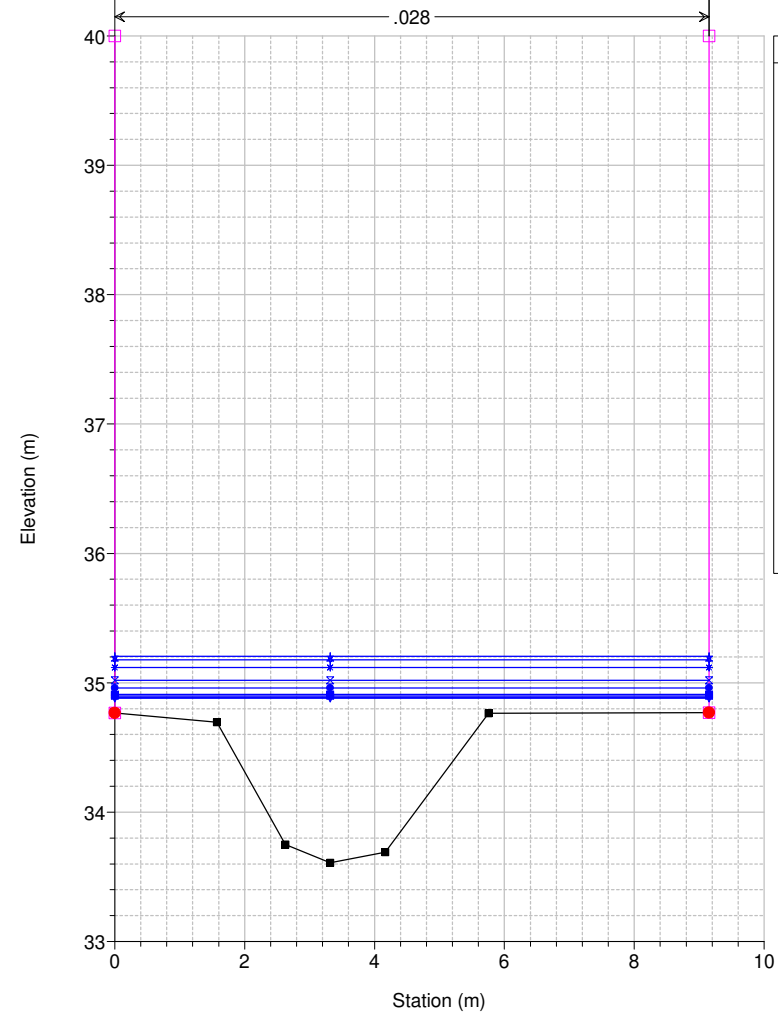

Studio Scandicci Torrenti Greve-Vingone
River = Fosso Stagnolo Reach = Stagnolo RS = 95 ST0007_

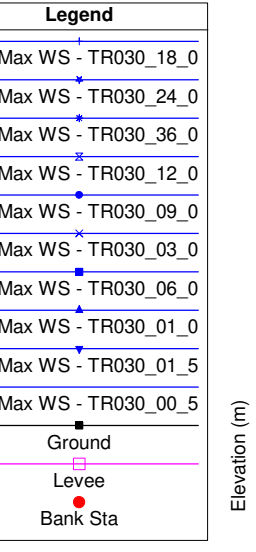
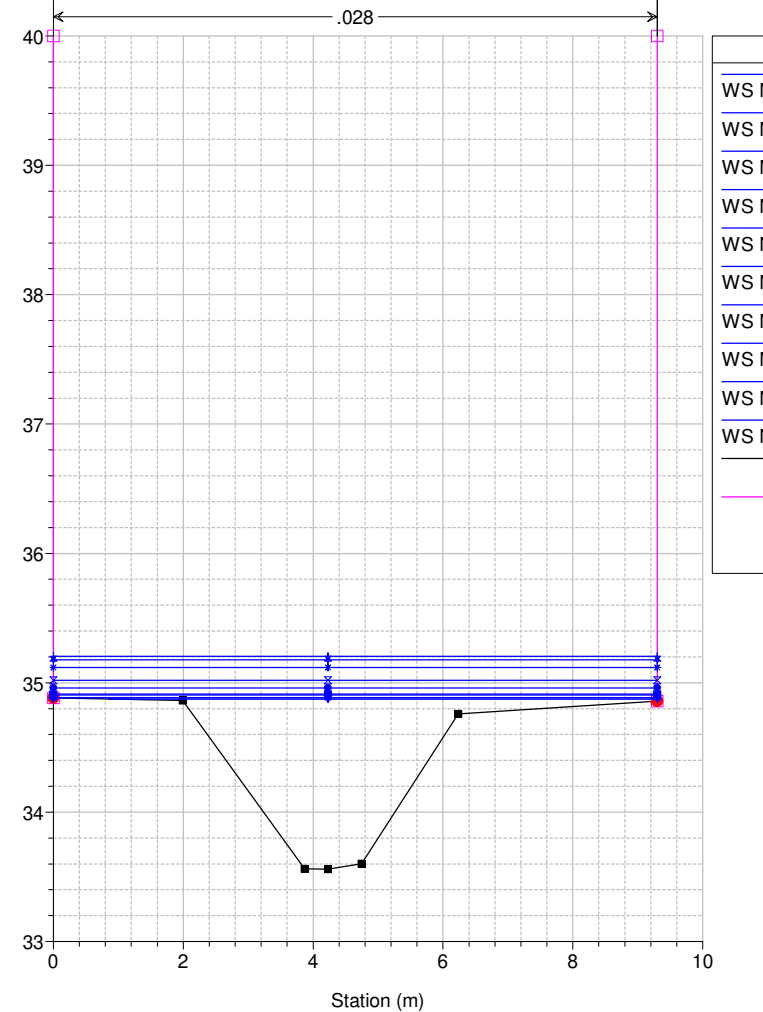

Studio Scandicci Torrenti Greve-Vingone
River = Fosso Stagnolo Reach = Stagnolo RS = 94 ST0008_A

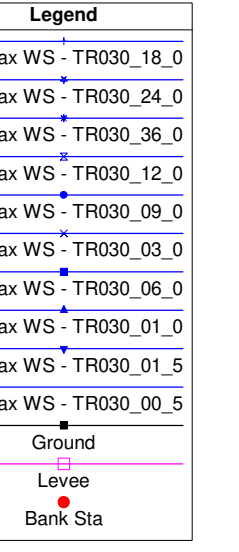
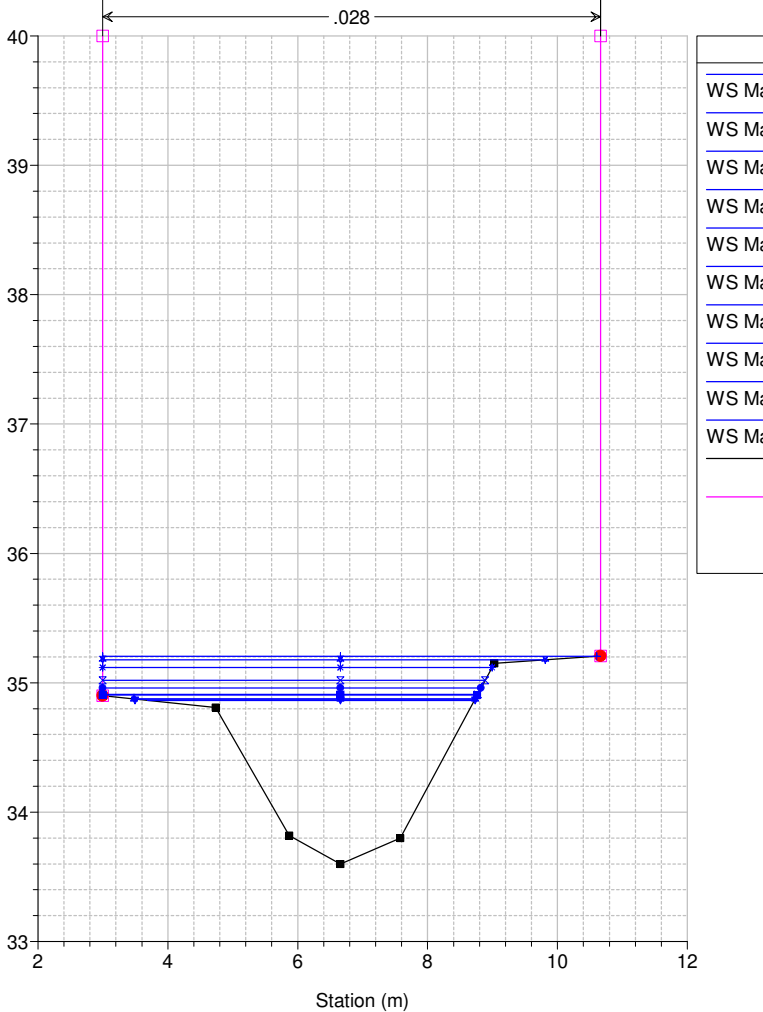

Studio Scandicci Torrenti Greve-Vingone
River = Fosso Stagnolo Reach = Stagnolo RS = 93 ST0008_B

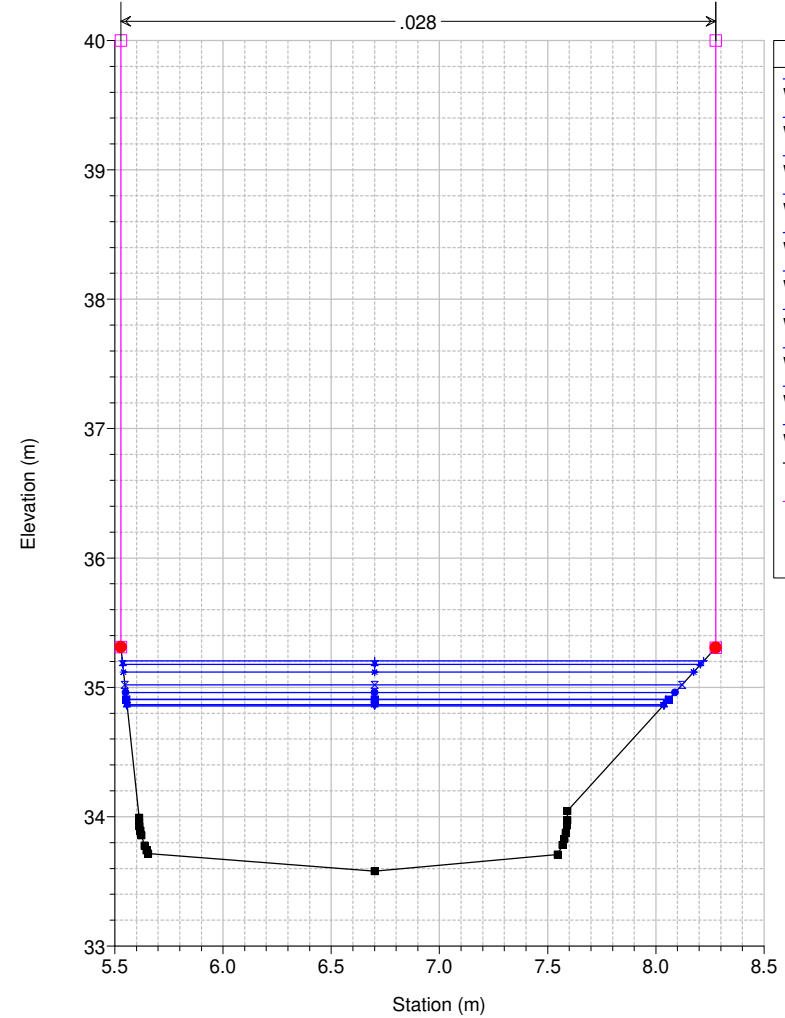

Legend	
WS Max WS - TR030_18_0	+
WS Max WS - TR030_24_0	*
WS Max WS - TR030_36_0	x
WS Max WS - TR030_12_0	•
WS Max WS - TR030_09_0	•
WS Max WS - TR030_03_0	x
WS Max WS - TR030_06_0	•
WS Max WS - TR030_01_0	•
WS Max WS - TR030_01_5	•
WS Max WS - TR030_00_5	•
Ground	■
Levee	□
Bank Sta	●

Studio Scandicci Torrenti Greve-Vingone
River = Fosso Stagnolo Reach = Stagnolo RS = 92.5 BR

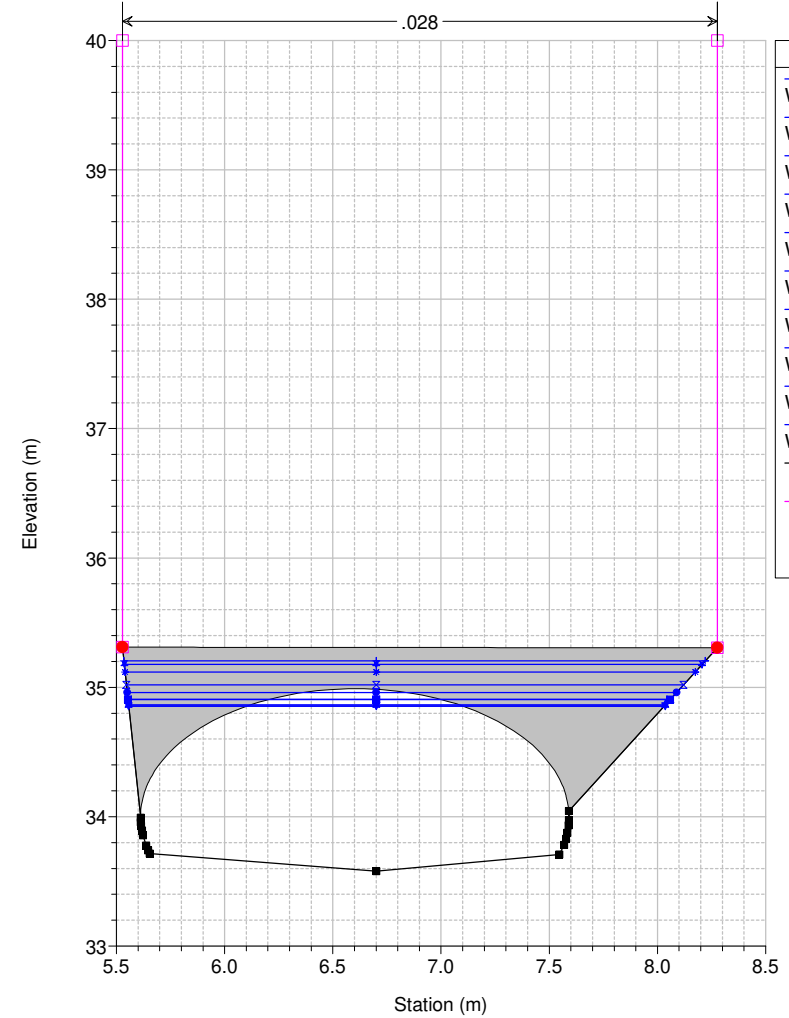

Legend	
WS Max WS - TR030_18_0	+
WS Max WS - TR030_24_0	*
WS Max WS - TR030_36_0	x
WS Max WS - TR030_12_0	•
WS Max WS - TR030_09_0	•
WS Max WS - TR030_03_0	x
WS Max WS - TR030_06_0	•
WS Max WS - TR030_01_0	•
WS Max WS - TR030_01_5	•
WS Max WS - TR030_00_5	•
Ground	■
Levee	□
Bank Sta	●

Studio Scandicci Torrenti Greve-Vingone
River = Fosso Stagnolo Reach = Stagnolo RS = 92.5 BR

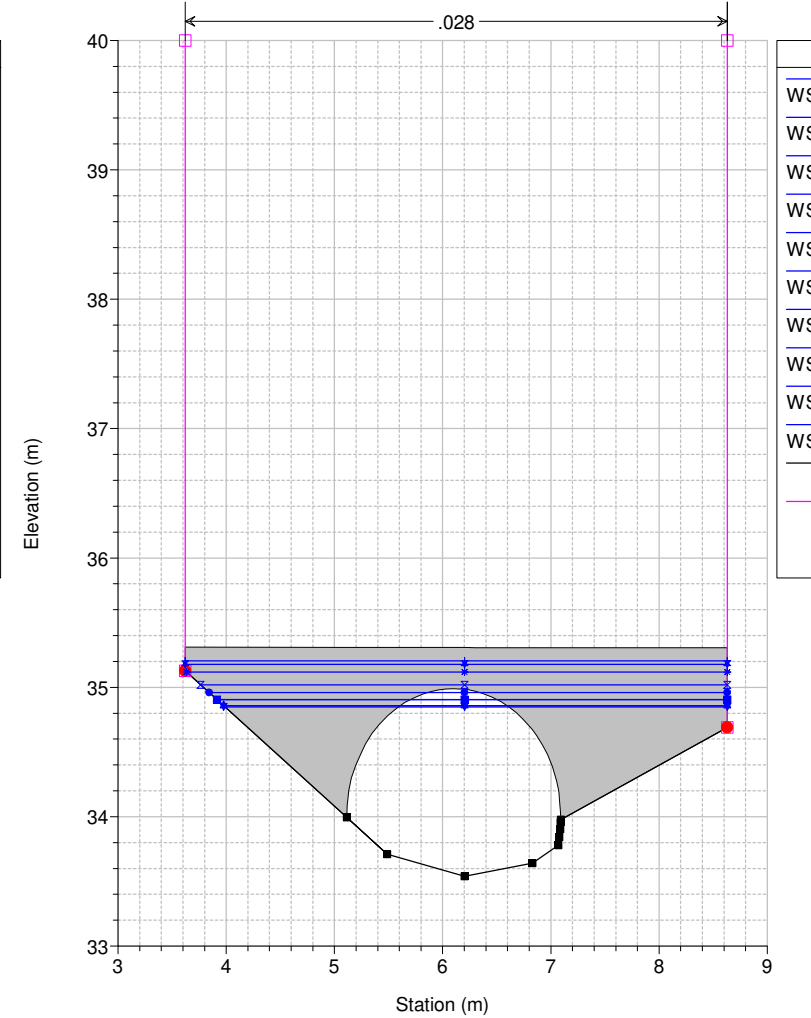

Legend	
WS Max WS - TR030_18_0	+
WS Max WS - TR030_24_0	*
WS Max WS - TR030_36_0	x
WS Max WS - TR030_12_0	•
WS Max WS - TR030_09_0	•
WS Max WS - TR030_03_0	x
WS Max WS - TR030_06_0	•
WS Max WS - TR030_01_5	•
WS Max WS - TR030_01_0	•
WS Max WS - TR030_00_5	•
Ground	■
Levee	□
Bank Sta	●

Studio Scandicci Torrenti Greve-Vingone
River = Fosso Stagnolo Reach = Stagnolo RS = 92 ST0008_C

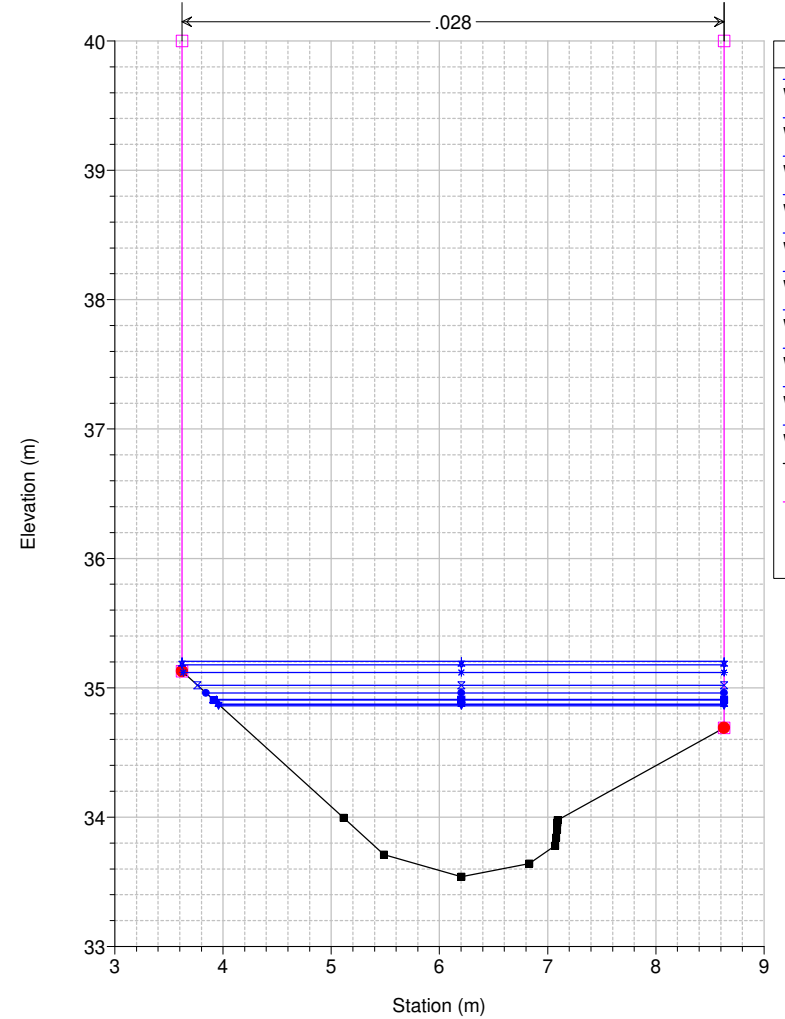

Legend	
WS Max WS - TR030_18_0	+
WS Max WS - TR030_24_0	*
WS Max WS - TR030_36_0	x
WS Max WS - TR030_12_0	•
WS Max WS - TR030_09_0	•
WS Max WS - TR030_03_0	x
WS Max WS - TR030_06_0	•
WS Max WS - TR030_01_0	•
WS Max WS - TR030_01_5	•
WS Max WS - TR030_00_5	•
Ground	■
Levee	□
Bank Sta	●

Studio Scandicci Torrenti Greve-Vingone
River = Fosso Stagnolo Reach = Stagnolo RS = 91 ST0008_D

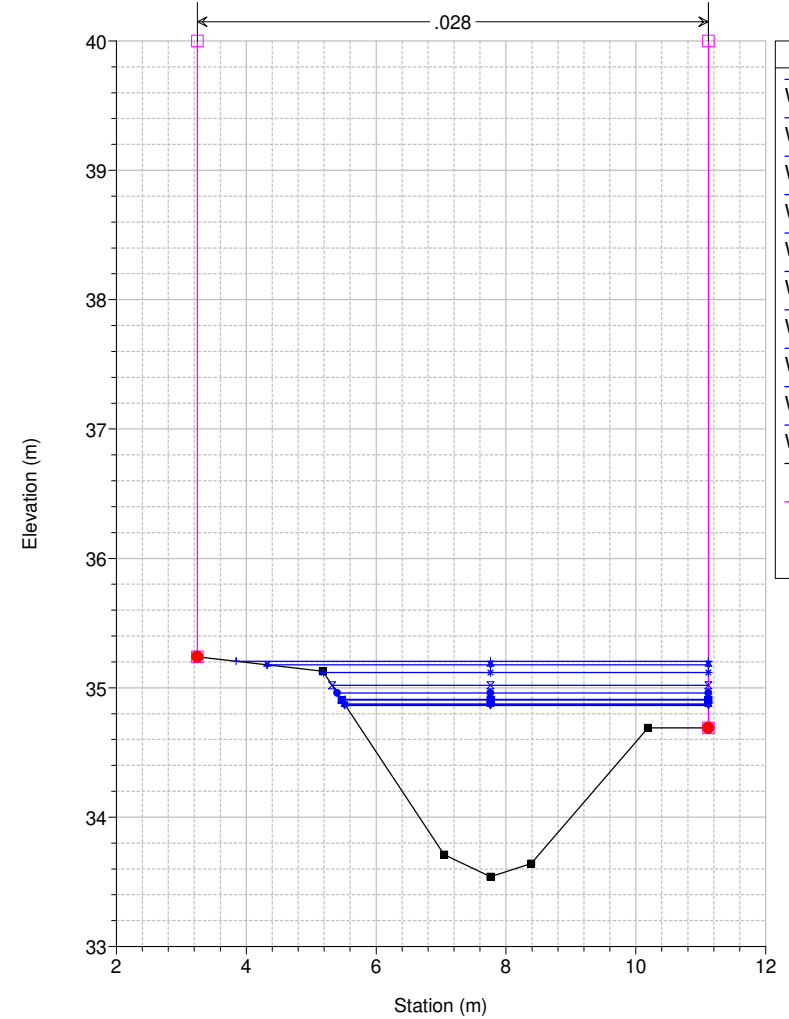

Legend	
WS Max WS - TR030_18_0	+
WS Max WS - TR030_24_0	*
WS Max WS - TR030_36_0	x
WS Max WS - TR030_12_0	•
WS Max WS - TR030_09_0	•
WS Max WS - TR030_03_0	x
WS Max WS - TR030_06_0	•
WS Max WS - TR030_01_0	•
WS Max WS - TR030_01_5	•
WS Max WS - TR030_00_5	•
Ground	■
Levee	□
Bank Sta	●

Studio Scandicci Torrenti Greve-Vingone
River = Fosso Stagnolo Reach = Stagnolo RS = 90 ST0009_

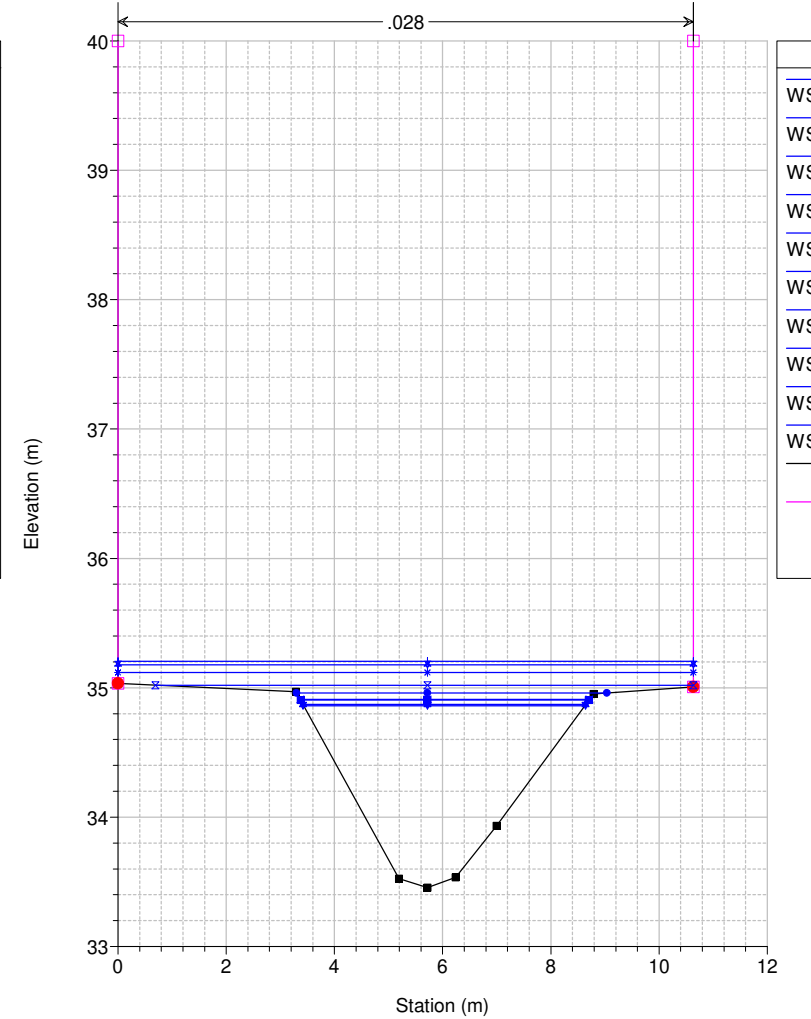

Legend	
WS Max WS - TR030_18_0	+
WS Max WS - TR030_24_0	*
WS Max WS - TR030_36_0	x
WS Max WS - TR030_12_0	•
WS Max WS - TR030_09_0	•
WS Max WS - TR030_03_0	x
WS Max WS - TR030_06_0	•
WS Max WS - TR030_01_0	•
WS Max WS - TR030_01_5	•
WS Max WS - TR030_00_5	•
Ground	■
Levee	□
Bank Sta	●

Studio Scandicci Torrenti Greve-Vingone
River = Fosso Stagnolo Reach = Stagnolo RS = 89 ST0010_

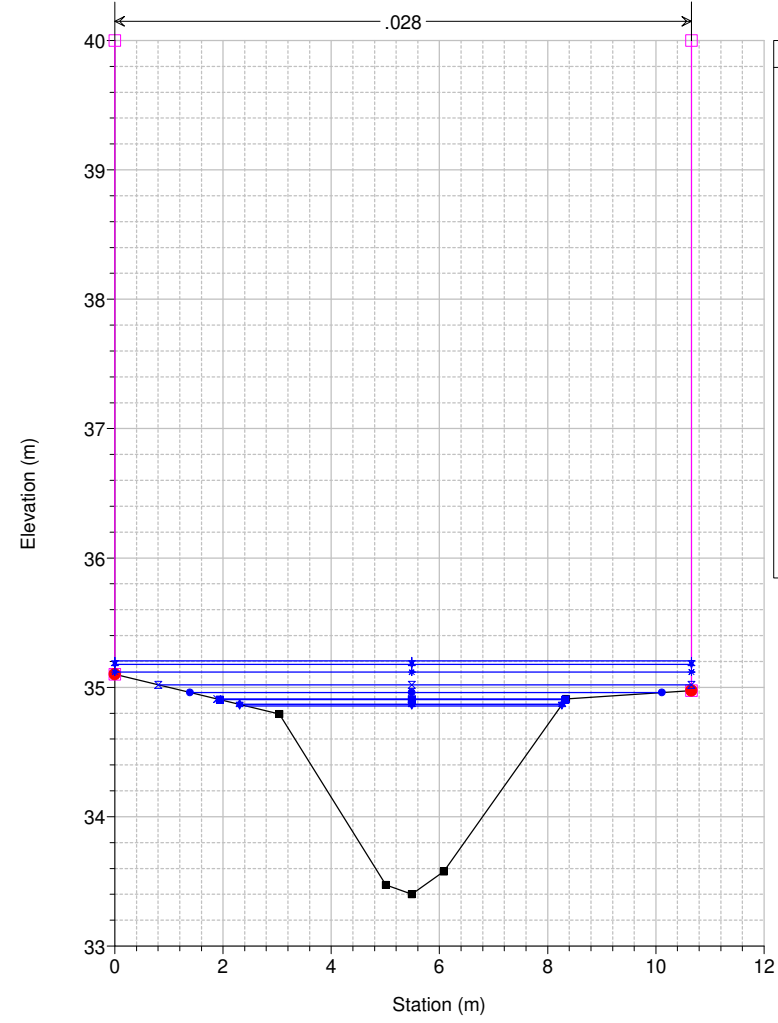

Legend

- WS Max WS - TR030_18_0
- WS Max WS - TR030_24_0
- WS Max WS - TR030_36_0
- WS Max WS - TR030_12_0
- WS Max WS - TR030_09_0
- WS Max WS - TR030_03_0
- WS Max WS - TR030_06_0
- WS Max WS - TR030_01_0
- WS Max WS - TR030_01_5
- WS Max WS - TR030_00_5
- Ground
- Levee
- Bank Sta

Studio Scandicci Torrenti Greve-Vingone
River = Fosso Stagnolo Reach = Stagnolo RS = 88 ST0011_A

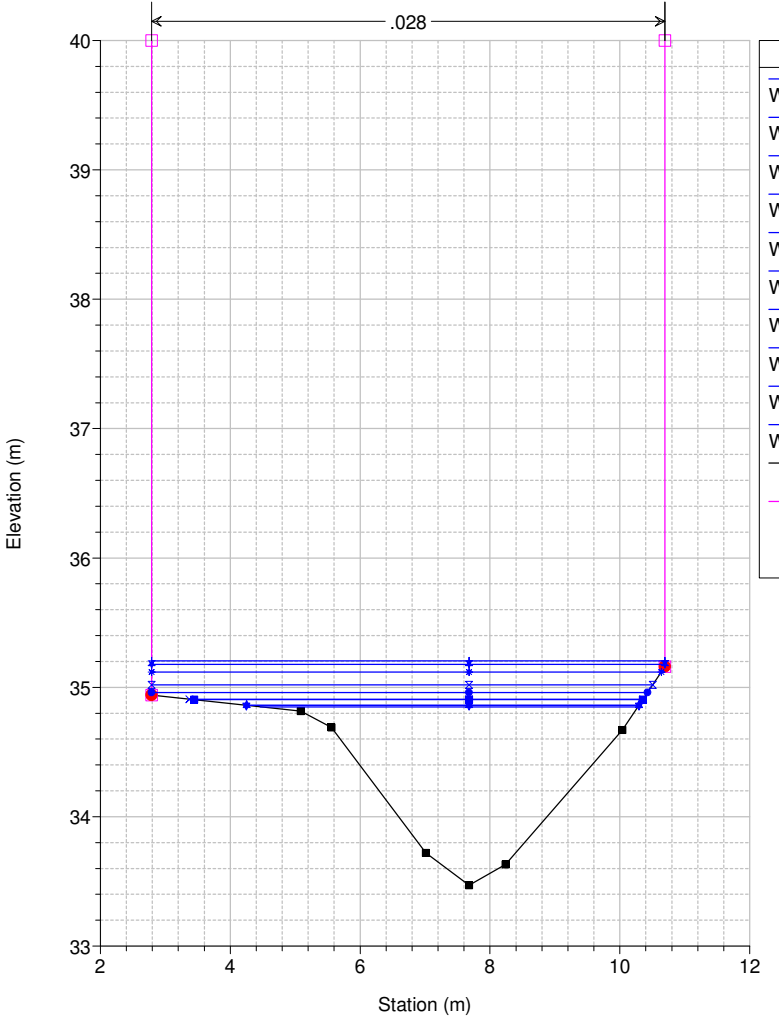

Legend

- WS Max WS - TR030_18_0
- WS Max WS - TR030_24_0
- WS Max WS - TR030_36_0
- WS Max WS - TR030_12_0
- WS Max WS - TR030_09_0
- WS Max WS - TR030_03_0
- WS Max WS - TR030_06_0
- WS Max WS - TR030_01_5
- WS Max WS - TR030_01_0
- WS Max WS - TR030_00_5
- Ground
- Levee
- Bank Sta

Studio Scandicci Torrenti Greve-Vingone
River = Fosso Stagnolo Reach = Stagnolo RS = 87 ST0011_B

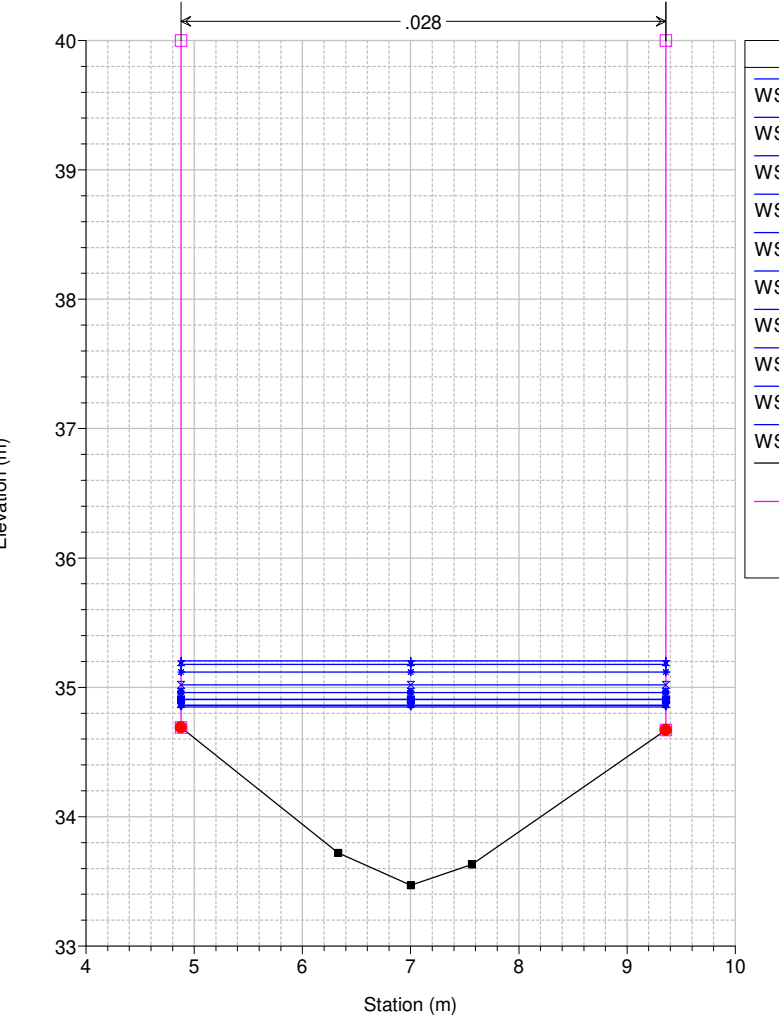

Legend

- WS Max WS - TR030_18_0
- WS Max WS - TR030_24_0
- WS Max WS - TR030_36_0
- WS Max WS - TR030_12_0
- WS Max WS - TR030_09_0
- WS Max WS - TR030_03_0
- WS Max WS - TR030_06_0
- WS Max WS - TR030_01_0
- WS Max WS - TR030_01_5
- WS Max WS - TR030_00_5
- Ground
- Levee
- Bank Sta

Studio Scandicci Torrenti Greve-Vingone
River = Fosso Stagnolo Reach = Stagnolo RS = 86.5 BR

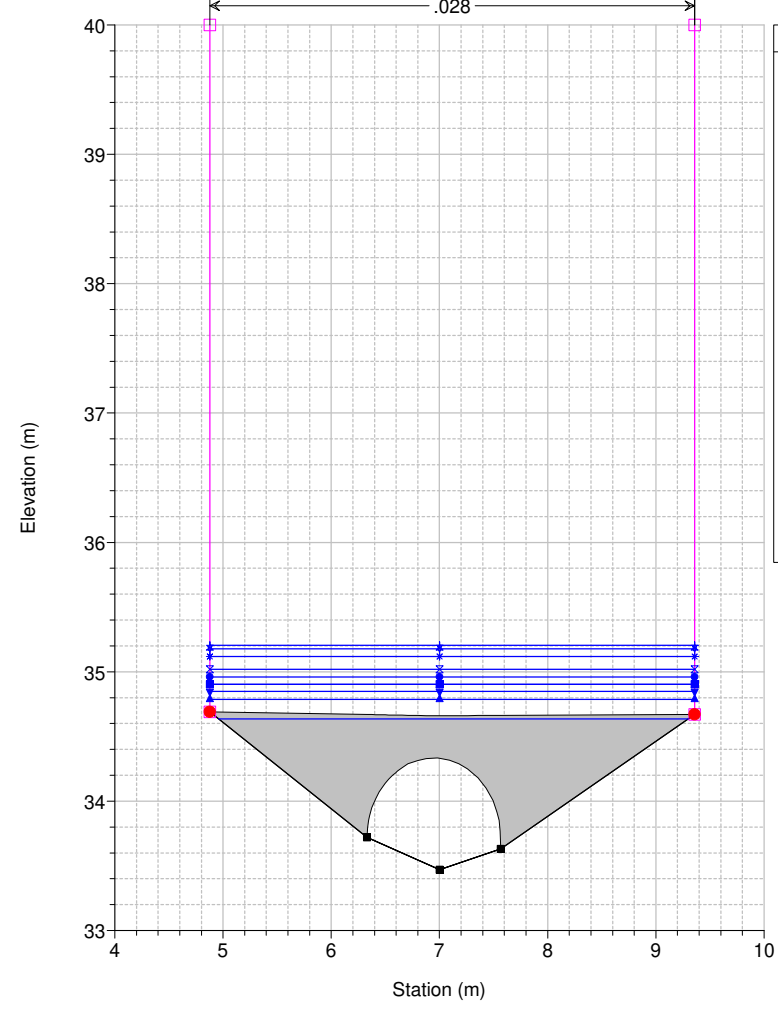

Legend

- WS Max WS - TR030_18_0
- WS Max WS - TR030_24_0
- WS Max WS - TR030_36_0
- WS Max WS - TR030_12_0
- WS Max WS - TR030_09_0
- WS Max WS - TR030_03_0
- WS Max WS - TR030_06_0
- WS Max WS - TR030_01_5
- WS Max WS - TR030_01_0
- WS Max WS - TR030_00_5
- Ground
- Levee
- Bank Sta

Studio Scandicci Torrenti Greve-Vingone
River = Fosso Stagnolo Reach = Stagnolo RS = 86.5 BR

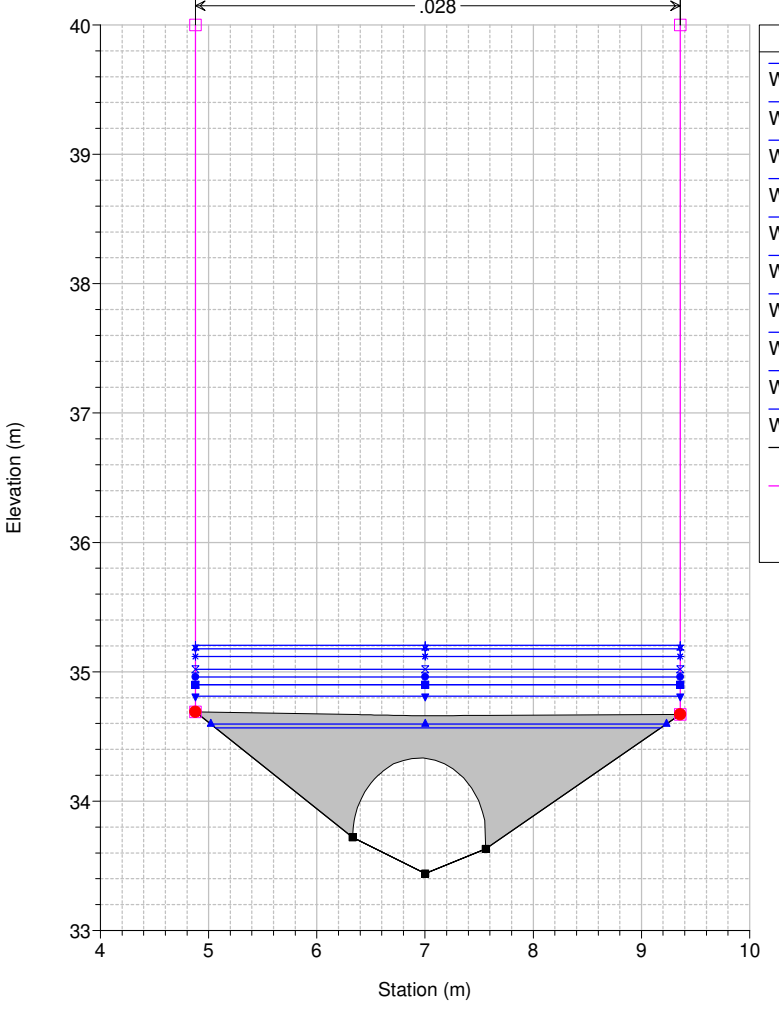

Legend

- WS Max WS - TR030_18_0
- WS Max WS - TR030_24_0
- WS Max WS - TR030_36_0
- WS Max WS - TR030_12_0
- WS Max WS - TR030_09_0
- WS Max WS - TR030_06_0
- WS Max WS - TR030_03_0
- WS Max WS - TR030_01_5
- WS Max WS - TR030_01_0
- WS Max WS - TR030_00_5
- Ground
- Levee
- Bank Sta

Studio Scandicci Torrenti Greve-Vingone
River = Fosso Stagnolo Reach = Stagnolo RS = 86 ST0011_C

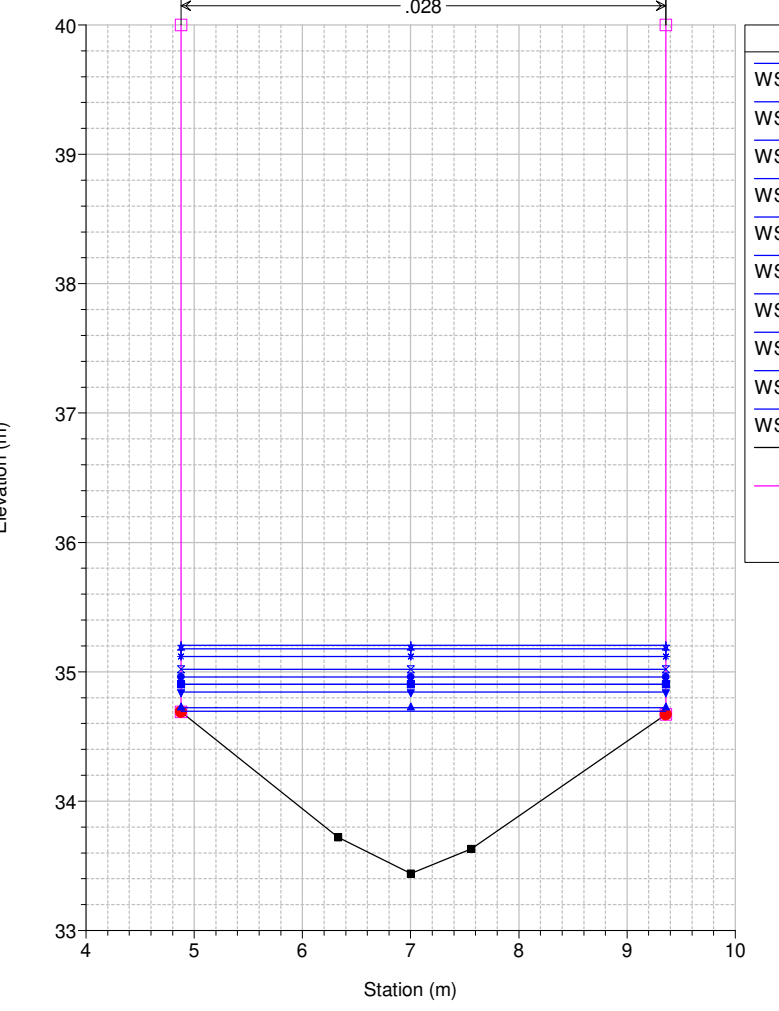

Legend

- WS Max WS - TR030_18_0
- WS Max WS - TR030_24_0
- WS Max WS - TR030_36_0
- WS Max WS - TR030_12_0
- WS Max WS - TR030_09_0
- WS Max WS - TR030_03_0
- WS Max WS - TR030_06_0
- WS Max WS - TR030_01_5
- WS Max WS - TR030_01_0
- WS Max WS - TR030_00_5
- Ground
- Levee
- Bank Sta

Studio Scandicci Torrenti Greve-Vingone
River = Fosso Stagnolo Reach = Stagnolo RS = 85 ST0011_D

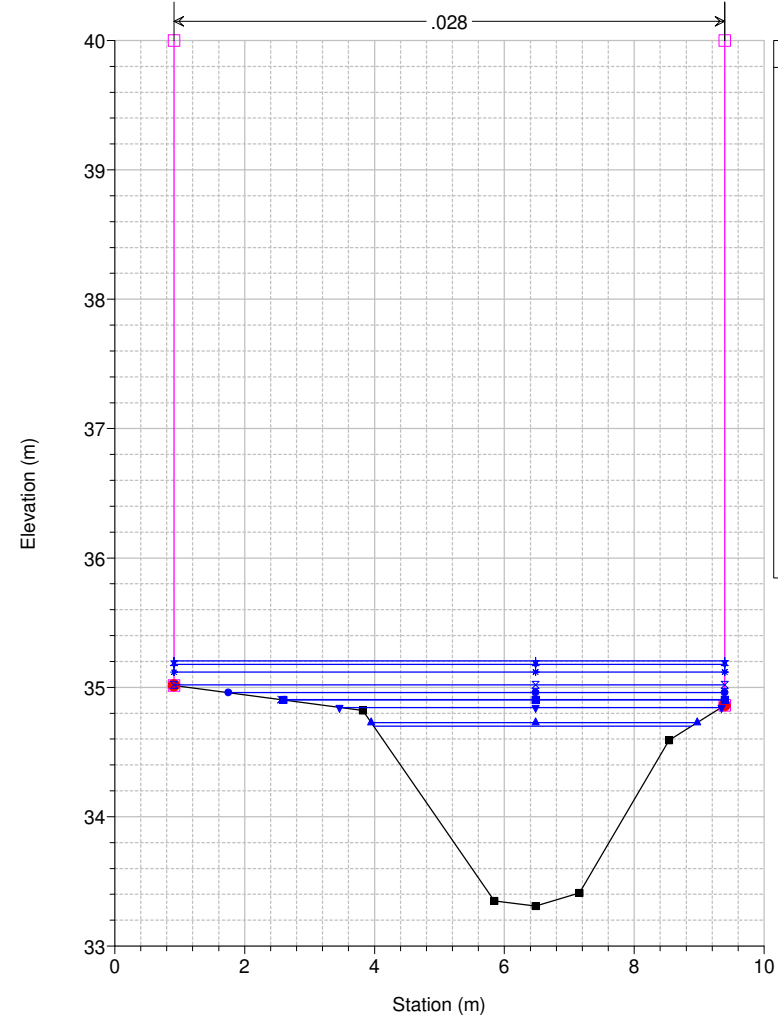

Legend

- WS Max WS - TR030_18_0
- WS Max WS - TR030_24_0
- WS Max WS - TR030_36_0
- WS Max WS - TR030_12_0
- WS Max WS - TR030_09_0
- WS Max WS - TR030_03_0
- WS Max WS - TR030_06_0
- WS Max WS - TR030_01_5
- WS Max WS - TR030_01_0
- WS Max WS - TR030_00_5
- Ground
- Levee
- Bank Sta

Studio Scandicci Torrenti Greve-Vingone
River = Fosso Stagnolo Reach = Stagnolo RS = 84 ST0012_

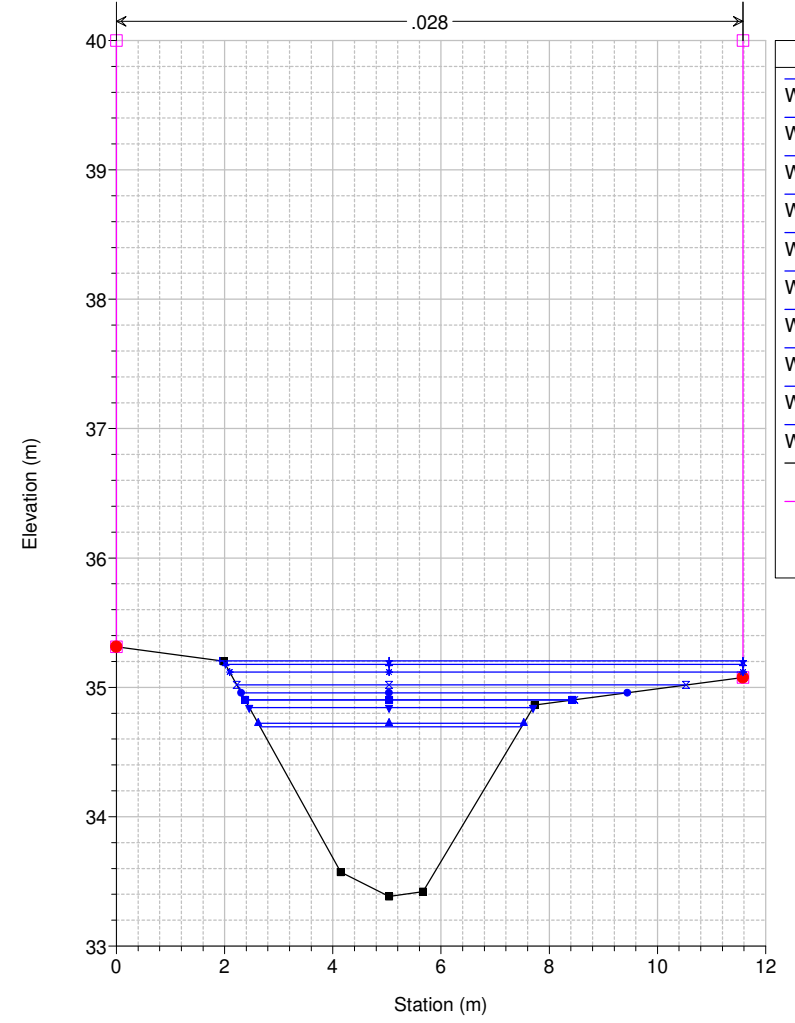

Legend

- WS Max WS - TR030_18_0
- WS Max WS - TR030_24_0
- WS Max WS - TR030_36_0
- WS Max WS - TR030_12_0
- WS Max WS - TR030_09_0
- WS Max WS - TR030_03_0
- WS Max WS - TR030_06_0
- WS Max WS - TR030_01_5
- WS Max WS - TR030_01_0
- WS Max WS - TR030_00_5
- Ground
- Levee
- Bank Sta

Studio Scandicci Torrenti Greve-Vingone
River = Fosso Stagnolo Reach = Stagnolo RS = 83 ST0013_

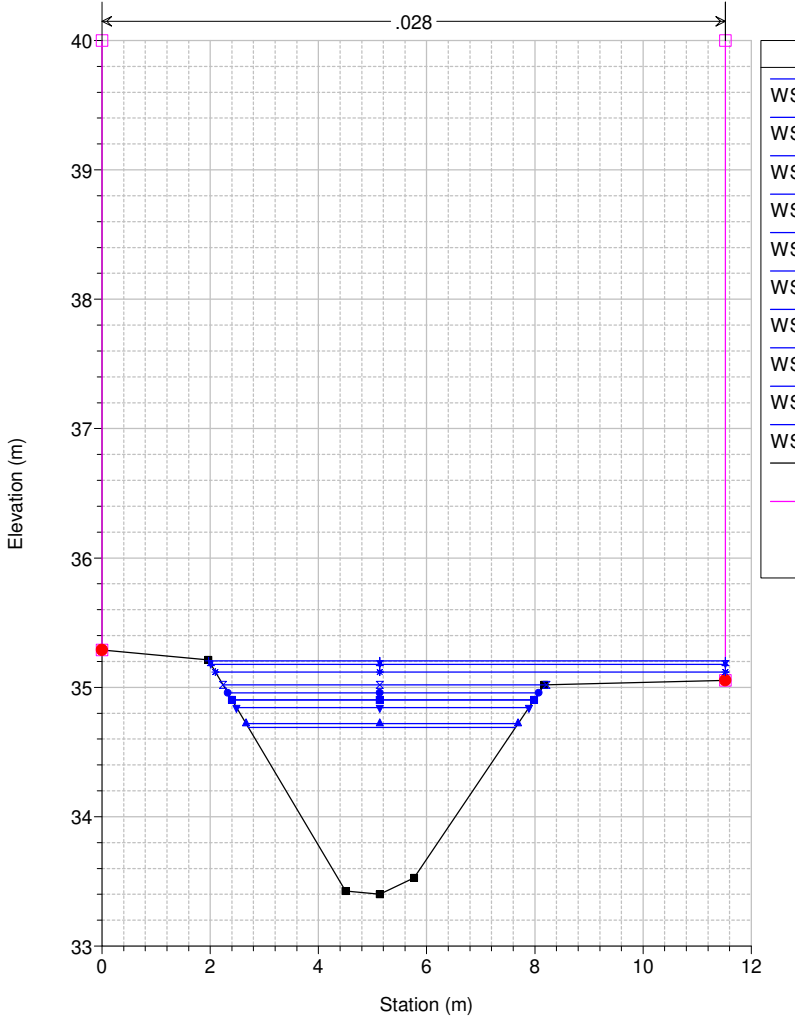

Legend

- WS Max WS - TR030_18_0
- WS Max WS - TR030_24_0
- WS Max WS - TR030_36_0
- WS Max WS - TR030_12_0
- WS Max WS - TR030_09_0
- WS Max WS - TR030_03_0
- WS Max WS - TR030_06_0
- WS Max WS - TR030_01_5
- WS Max WS - TR030_01_0
- WS Max WS - TR030_00_5
- Ground
- Levee
- Bank Sta

Studio Scandicci Torrenti Greve-Vingone
River = Fosso Stagnolo Reach = Stagnolo RS = 82 ST0014_

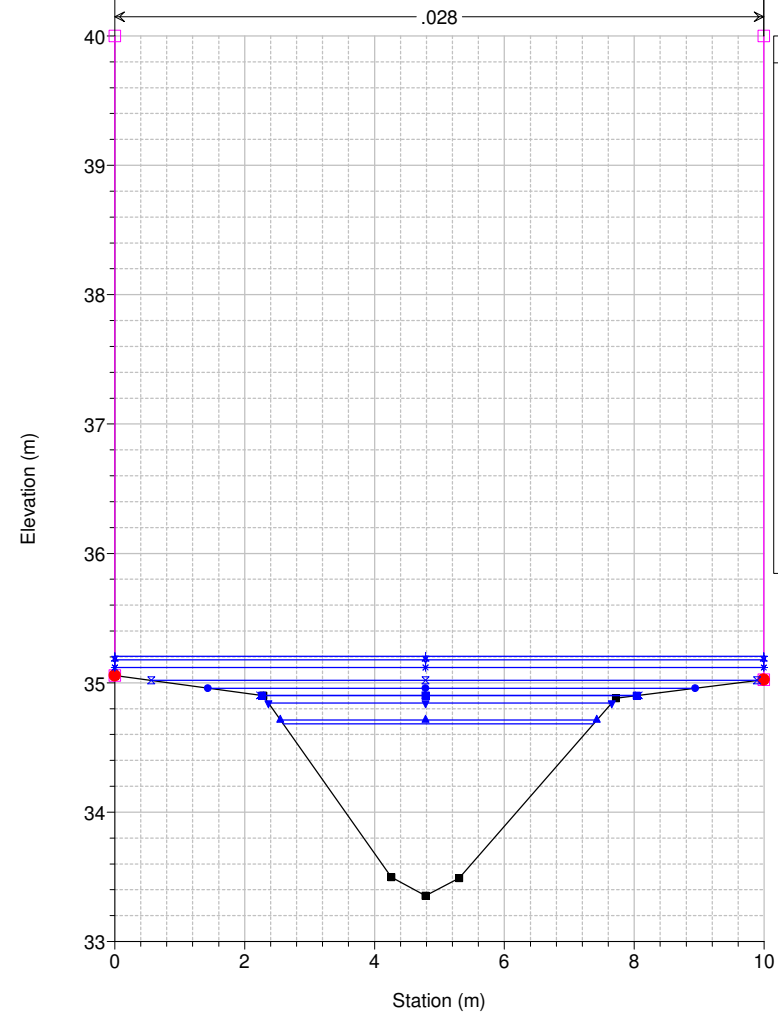

Legend

- WS Max WS - TR030_18_0
- WS Max WS - TR030_24_0
- WS Max WS - TR030_36_0
- WS Max WS - TR030_12_0
- WS Max WS - TR030_09_0
- WS Max WS - TR030_03_0
- WS Max WS - TR030_06_0
- WS Max WS - TR030_01_5
- WS Max WS - TR030_01_0
- WS Max WS - TR030_00_5
- Ground
- Levee
- Bank Sta

Studio Scandicci Torrenti Greve-Vingone
River = Fosso Stagnolo Reach = Stagnolo RS = 81 ST0015_

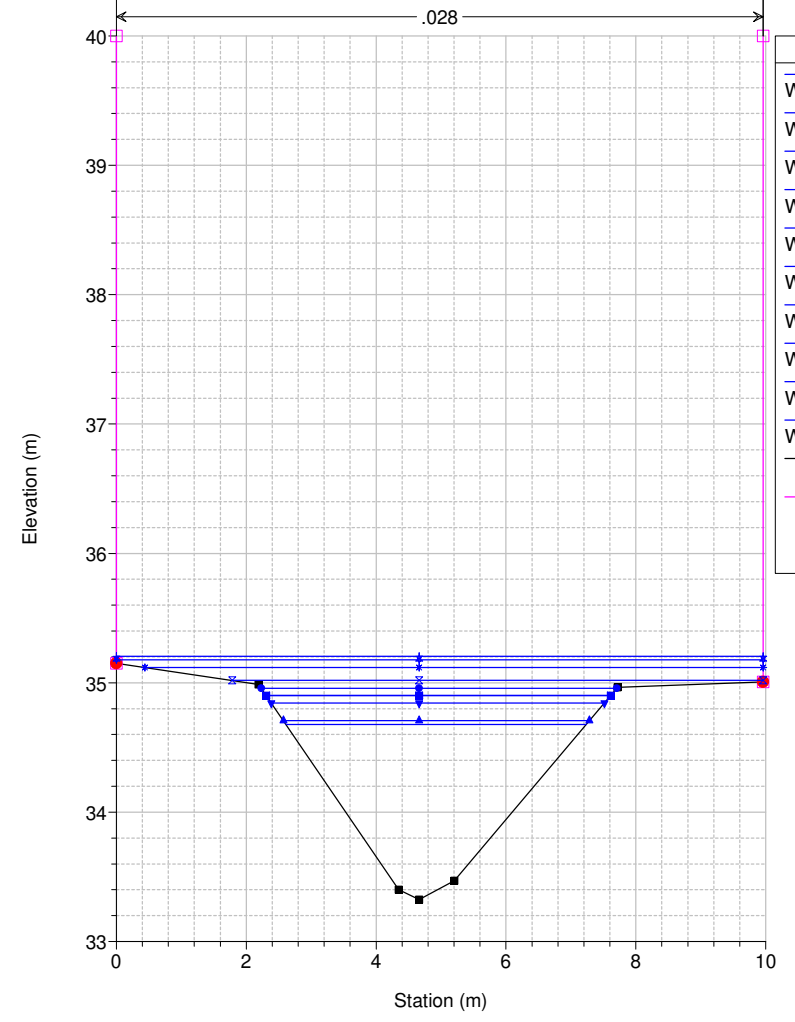

Legend

- WS Max WS - TR030_18_0
- WS Max WS - TR030_24_0
- WS Max WS - TR030_36_0
- WS Max WS - TR030_12_0
- WS Max WS - TR030_09_0
- WS Max WS - TR030_03_0
- WS Max WS - TR030_06_0
- WS Max WS - TR030_01_5
- WS Max WS - TR030_01_0
- WS Max WS - TR030_00_5
- Ground
- Levee
- Bank Sta

Studio Scandicci Torrenti Greve-Vingone
River = Fosso Stagnolo Reach = Stagnolo RS = 80 ST0016_

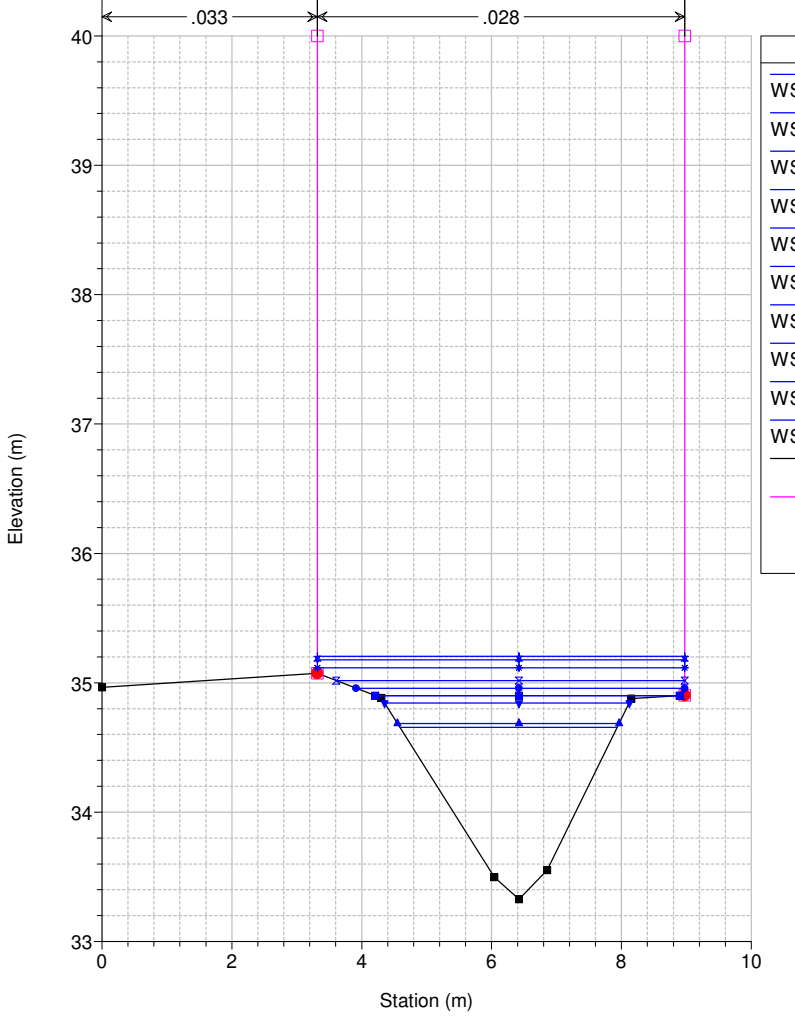

Legend

- WS Max WS - TR030_18_0
- WS Max WS - TR030_24_0
- WS Max WS - TR030_36_0
- WS Max WS - TR030_12_0
- WS Max WS - TR030_09_0
- WS Max WS - TR030_03_0
- WS Max WS - TR030_06_0
- WS Max WS - TR030_01_5
- WS Max WS - TR030_01_0
- WS Max WS - TR030_00_5
- Ground
- Levee
- Bank Sta

Studio Scandicci Torrenti Greve-Vingone
River = Fosso Stagnolo Reach = Stagnolo RS = 79 ST0017__

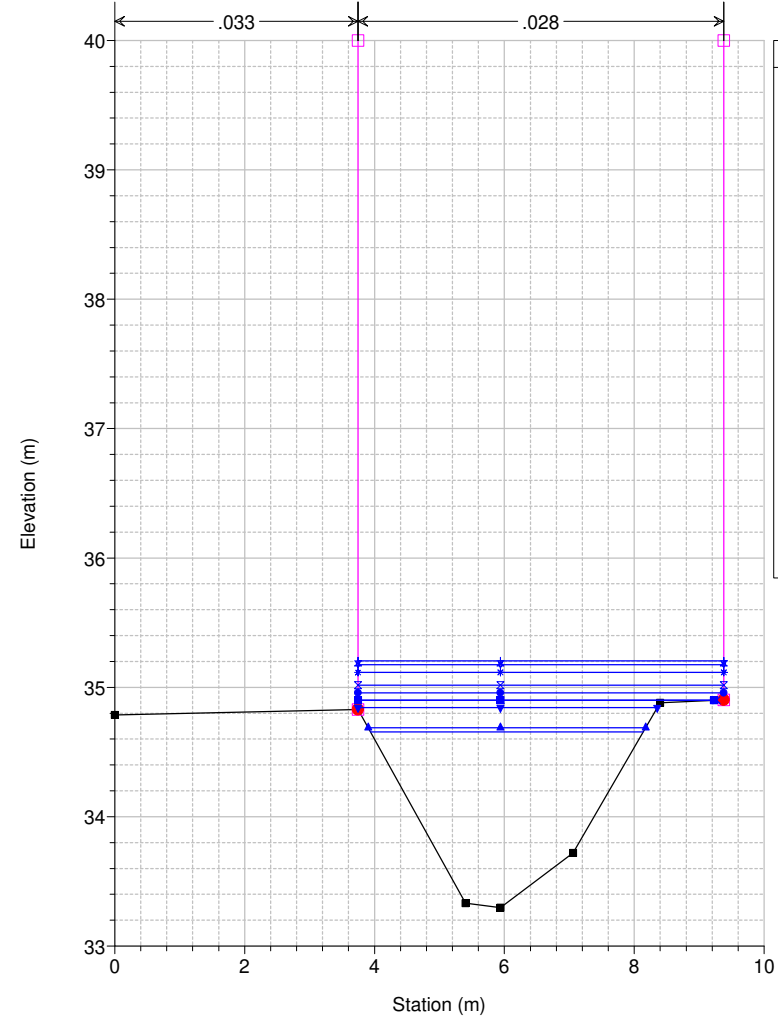

Legend

- WS Max WS - TR030_18_0
- WS Max WS - TR030_24_0
- WS Max WS - TR030_36_0
- WS Max WS - TR030_12_0
- WS Max WS - TR030_09_0
- WS Max WS - TR030_03_0
- WS Max WS - TR030_06_0
- WS Max WS - TR030_01_5
- WS Max WS - TR030_01_0
- WS Max WS - TR030_00_5
- Ground
- Levee
- Bank Sta

Studio Scandicci Torrenti Greve-Vingone
River = Fosso Stagnolo Reach = Stagnolo RS = 78 ST0018__

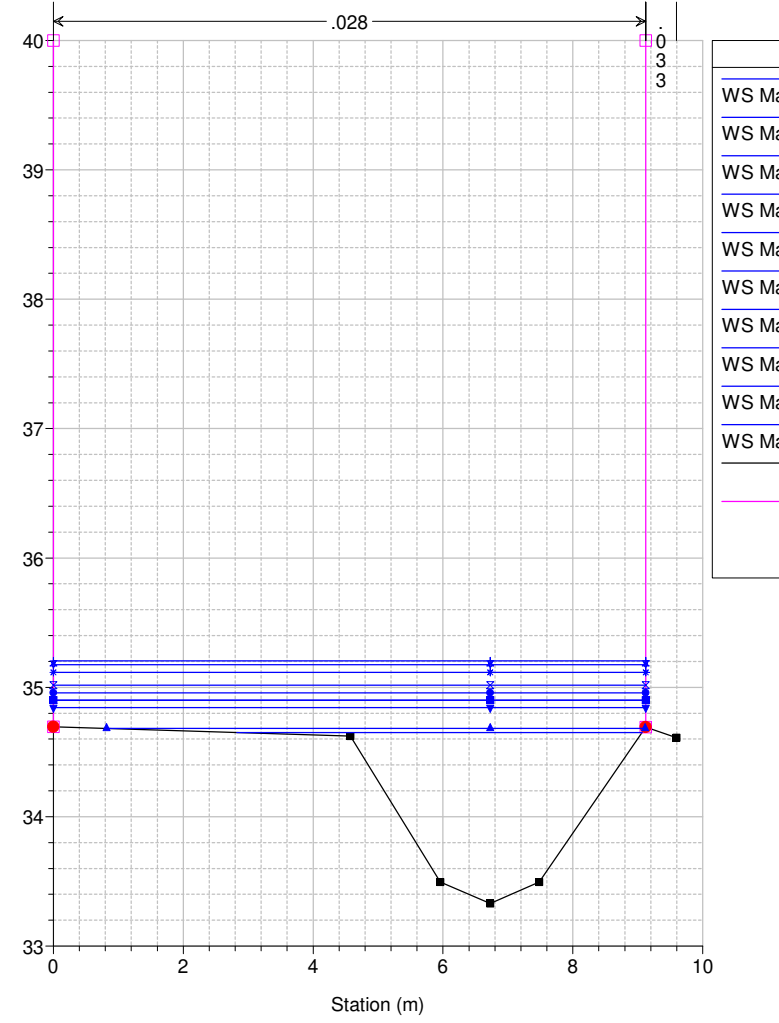

Legend

- WS Max WS - TR030_18_0
- WS Max WS - TR030_24_0
- WS Max WS - TR030_36_0
- WS Max WS - TR030_12_0
- WS Max WS - TR030_09_0
- WS Max WS - TR030_03_0
- WS Max WS - TR030_06_0
- WS Max WS - TR030_01_5
- WS Max WS - TR030_01_0
- WS Max WS - TR030_00_5
- Ground
- Levee
- Bank Sta

Studio Scandicci Torrenti Greve-Vingone
River = Fosso Stagnolo Reach = Stagnolo RS = 77 ST0019_A

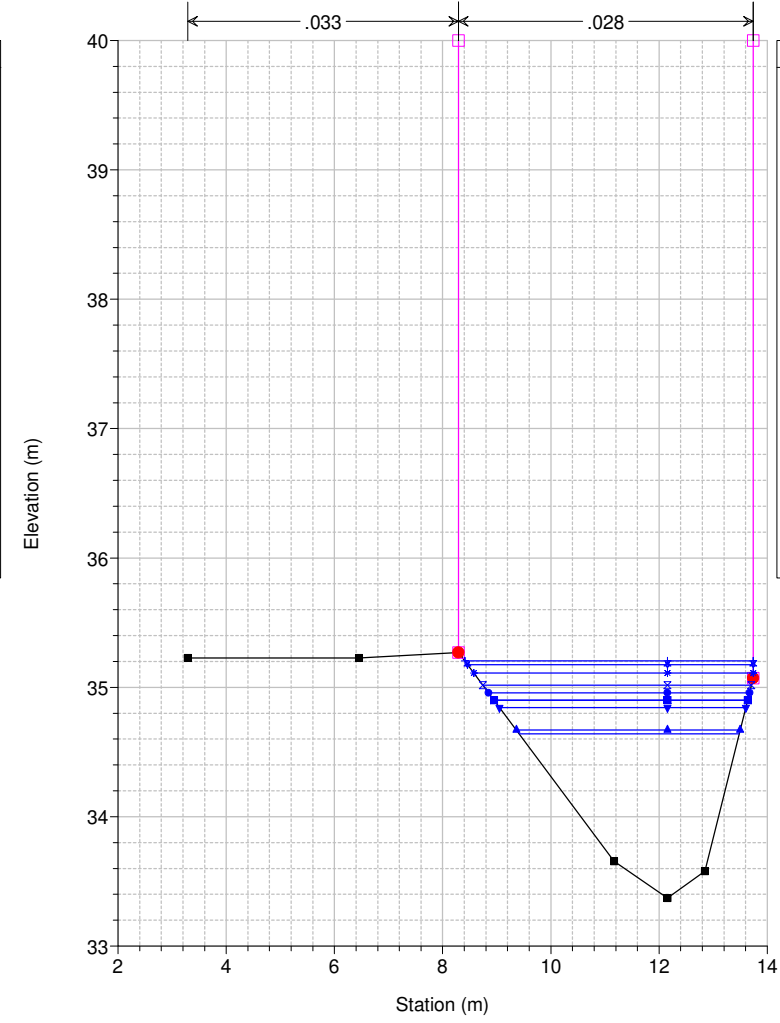

Legend

- WS Max WS - TR030_18_0
- WS Max WS - TR030_24_0
- WS Max WS - TR030_36_0
- WS Max WS - TR030_12_0
- WS Max WS - TR030_09_0
- WS Max WS - TR030_03_0
- WS Max WS - TR030_06_0
- WS Max WS - TR030_01_5
- WS Max WS - TR030_01_0
- WS Max WS - TR030_00_5
- Ground
- Levee
- Bank Sta

Studio Scandicci Torrenti Greve-Vingone
River = Fosso Stagnolo Reach = Stagnolo RS = 76 ST0019_B

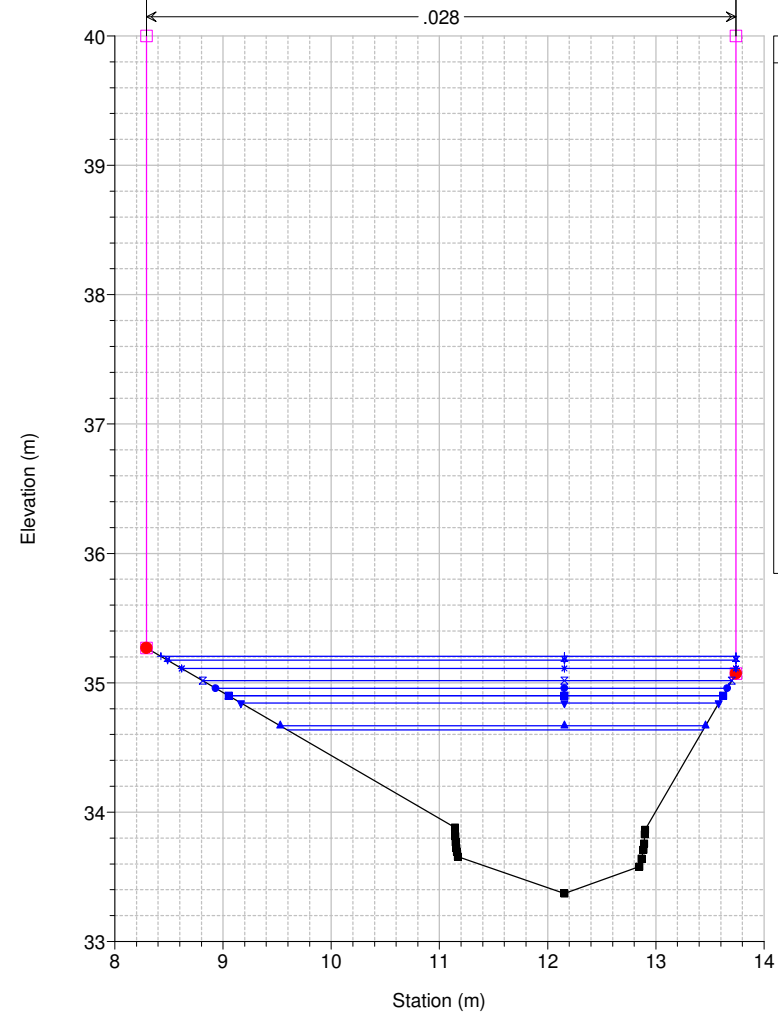

Legend

- WS Max WS - TR030_18_0
- WS Max WS - TR030_24_0
- WS Max WS - TR030_36_0
- WS Max WS - TR030_12_0
- WS Max WS - TR030_09_0
- WS Max WS - TR030_03_0
- WS Max WS - TR030_06_0
- WS Max WS - TR030_01_5
- WS Max WS - TR030_01_0
- WS Max WS - TR030_00_5
- Ground
- Levee
- Bank Sta

Studio Scandicci Torrenti Greve-Vingone
River = Fosso Stagnolo Reach = Stagnolo RS = 75.5 BR

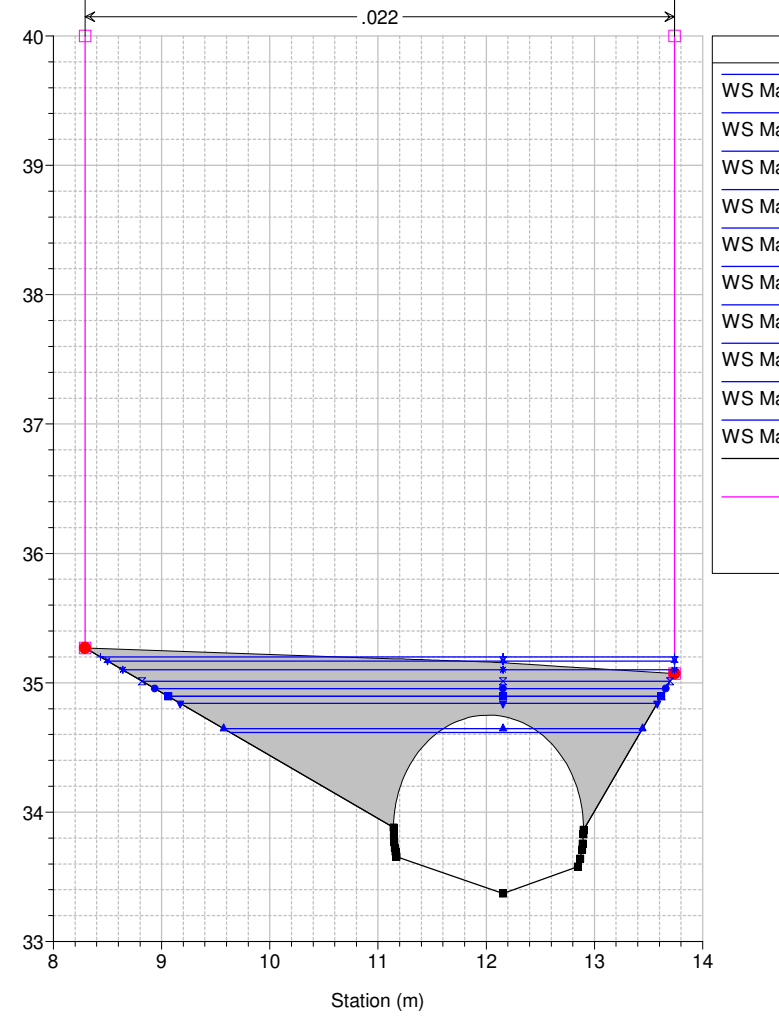

Legend

- WS Max WS - TR030_18_0
- WS Max WS - TR030_24_0
- WS Max WS - TR030_36_0
- WS Max WS - TR030_12_0
- WS Max WS - TR030_09_0
- WS Max WS - TR030_03_0
- WS Max WS - TR030_06_0
- WS Max WS - TR030_01_5
- WS Max WS - TR030_01_0
- WS Max WS - TR030_00_5
- Ground
- Levee
- Bank Sta

Studio Scandicci Torrenti Greve-Vingone
River = Fosso Stagnolo Reach = Stagnolo RS = 75.5 BR

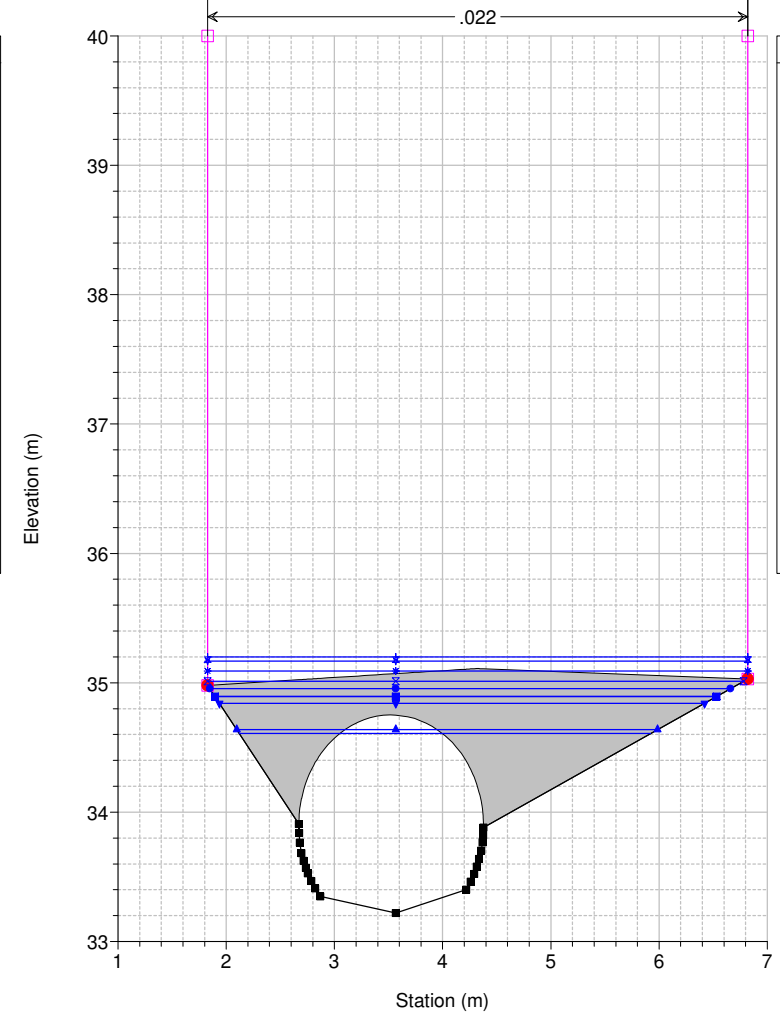

Legend

- WS Max WS - TR030_18_0
- WS Max WS - TR030_24_0
- WS Max WS - TR030_36_0
- WS Max WS - TR030_12_0
- WS Max WS - TR030_09_0
- WS Max WS - TR030_03_0
- WS Max WS - TR030_06_0
- WS Max WS - TR030_01_5
- WS Max WS - TR030_01_0
- WS Max WS - TR030_00_5
- Ground
- Levee
- Bank Sta

Studio Scandicci Torrenti Greve-Vingone
River = Fosso Stagnolo Reach = Stagnolo RS = 75 ST0019_C

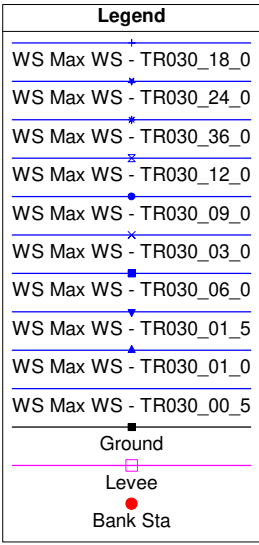
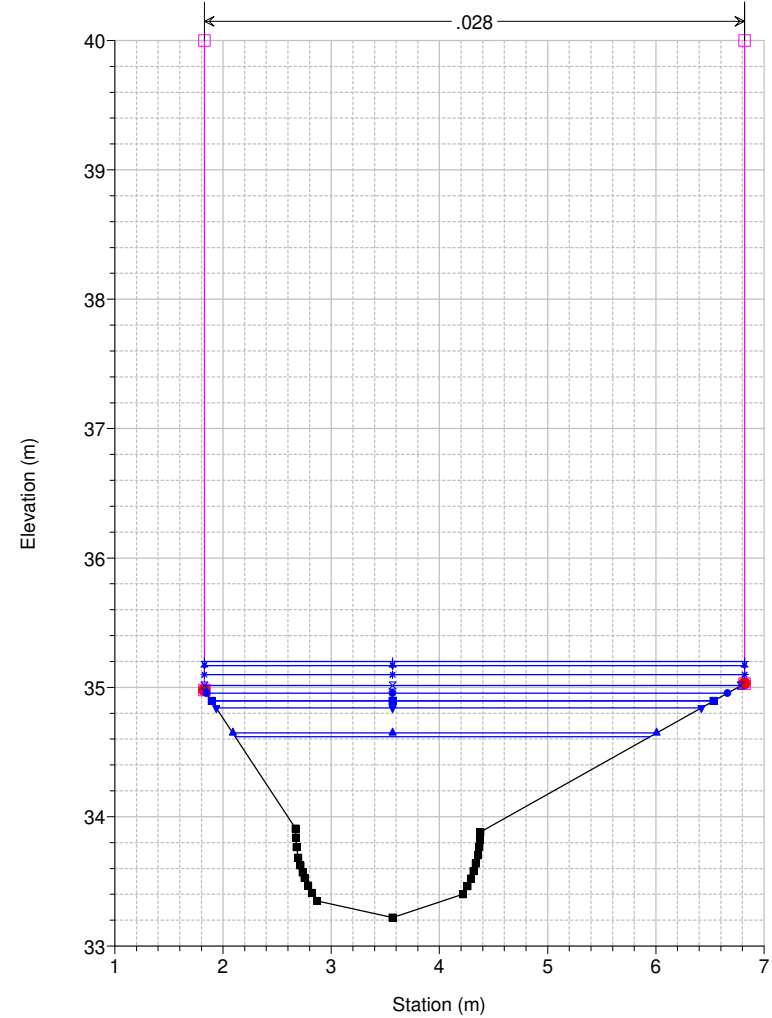

Studio Scandicci Torrenti Greve-Vingone
River = Fosso Stagnolo Reach = Stagnolo RS = 74 ST0019_D

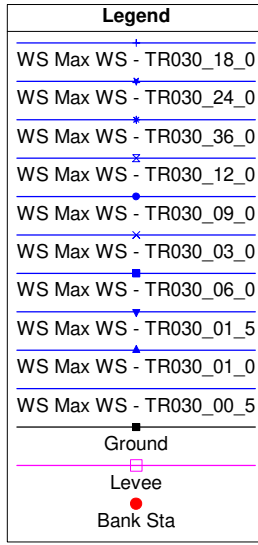
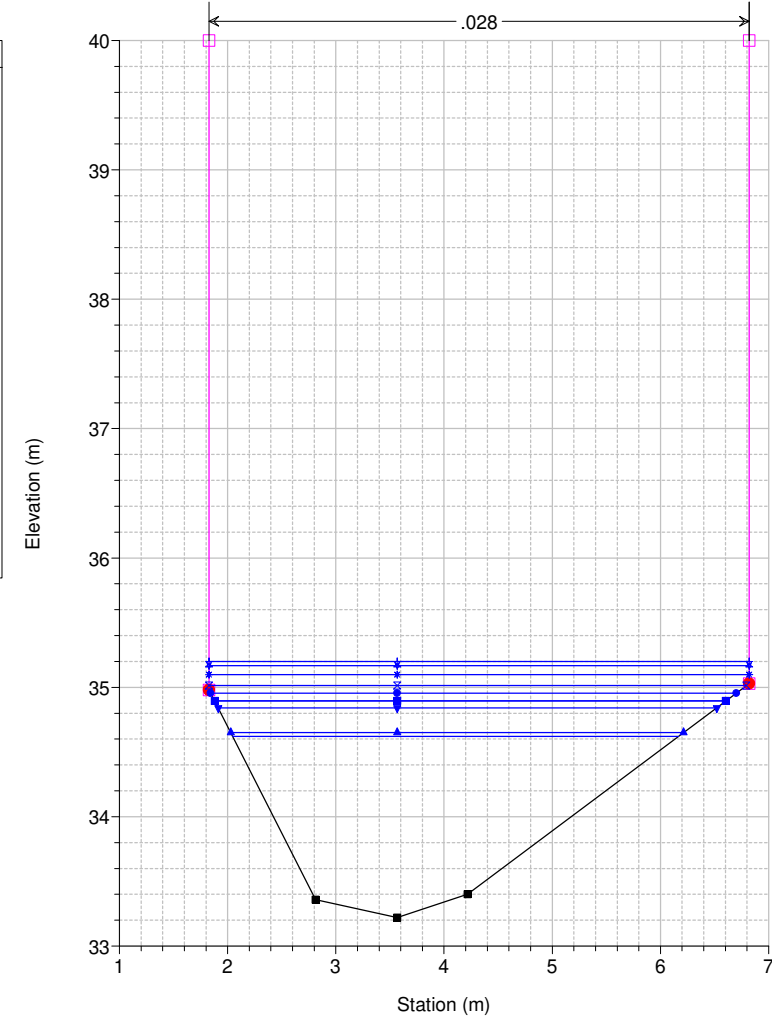

Studio Scandicci Torrenti Greve-Vingone
River = Fosso Stagnolo Reach = Stagnolo RS = 73 ST0020_

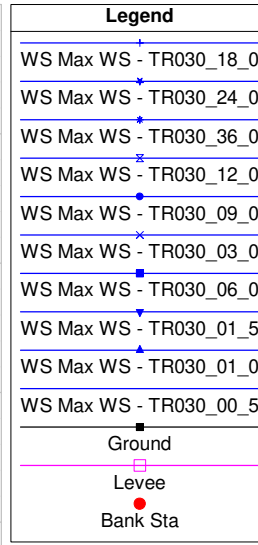
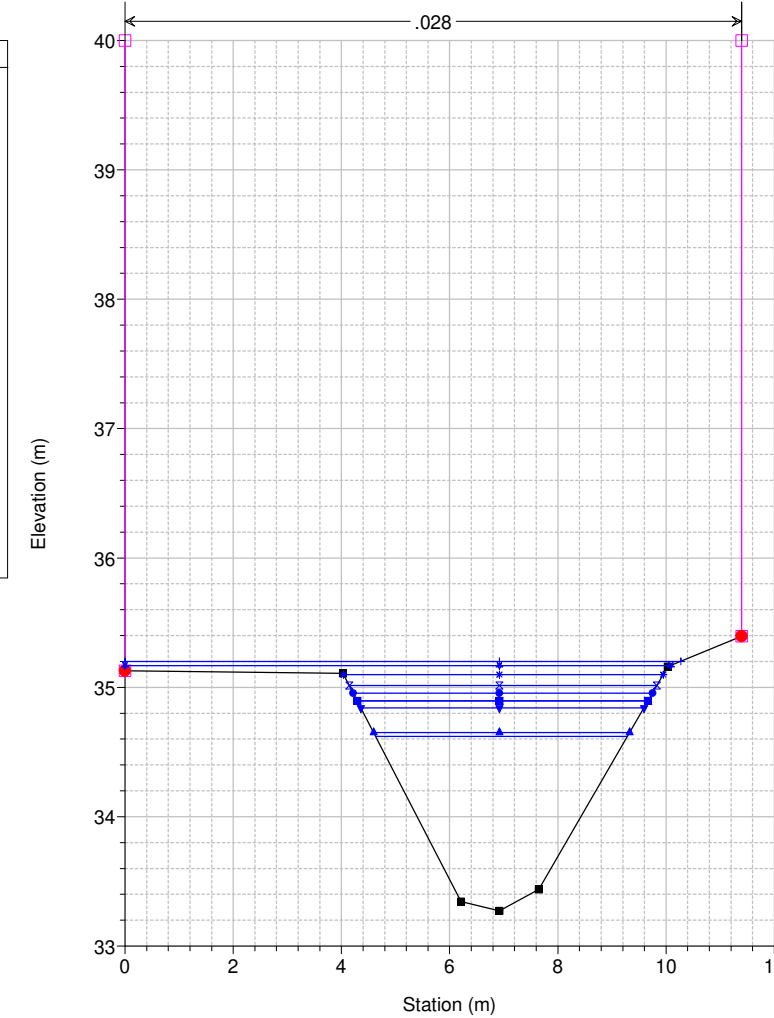

Studio Scandicci Torrenti Greve-Vingone
River = Fosso Stagnolo Reach = Stagnolo RS = 72 ST0021_A

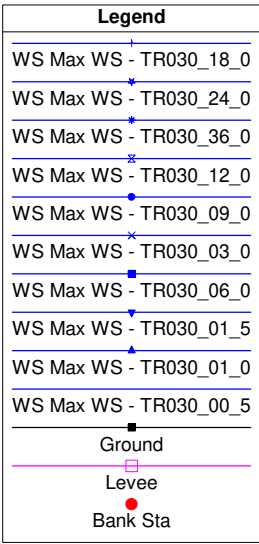
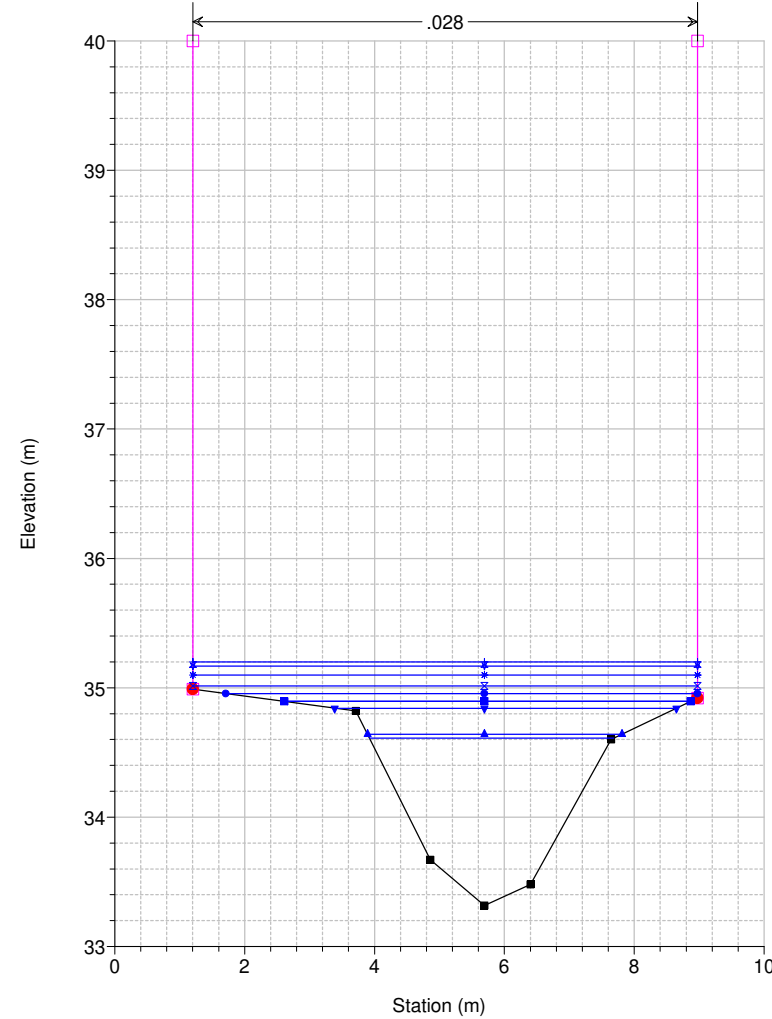

Studio Scandicci Torrenti Greve-Vingone
River = Fosso Stagnolo Reach = Stagnolo RS = 71 ST0021_B

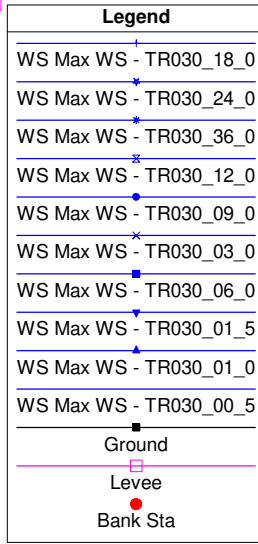
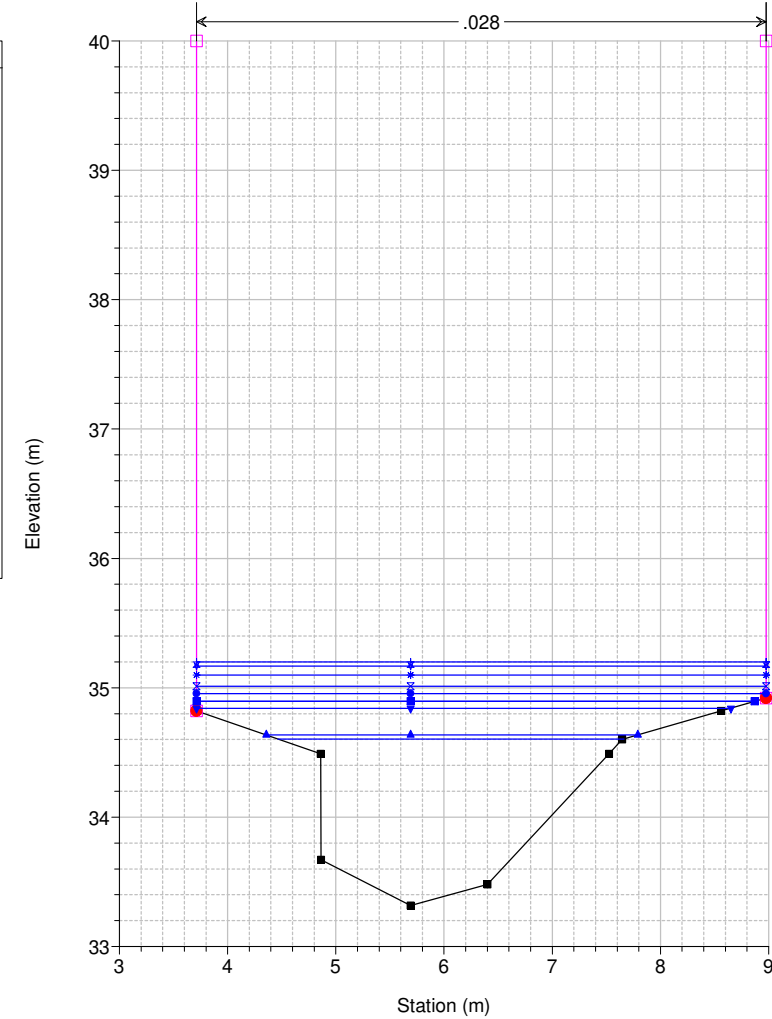

Studio Scandicci Torrenti Greve-Vingone
River = Fosso Stagnolo Reach = Stagnolo RS = 70.5 BR

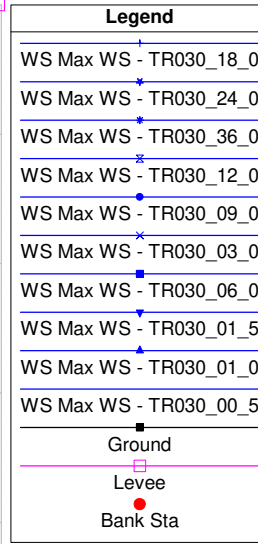
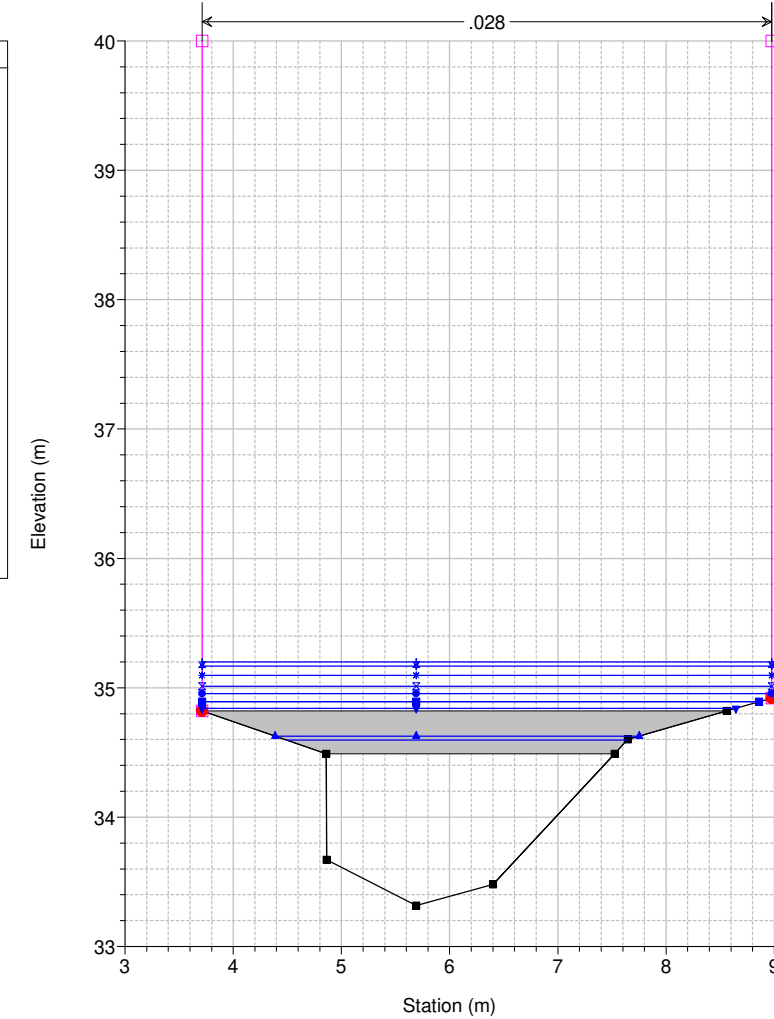

Studio Scandicci Torrenti Greve-Vingone
River = Fosso Stagnolo Reach = Stagnolo RS = 70.5 BR

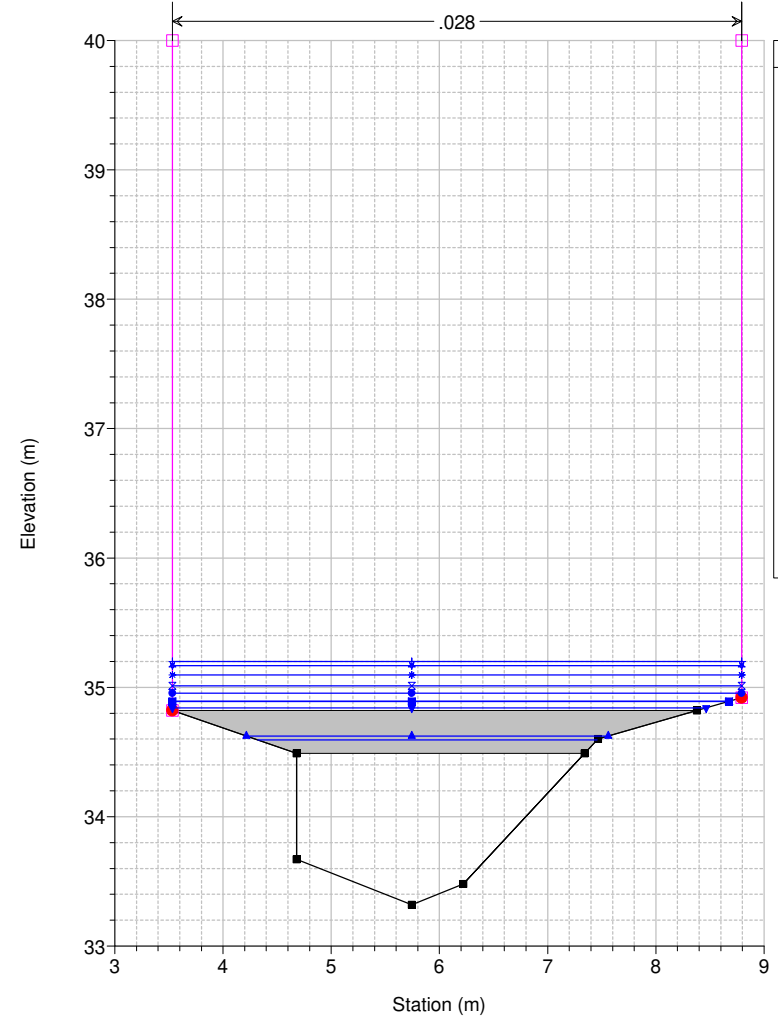

Legend	
WS Max WS - TR030_18_0	+
WS Max WS - TR030_24_0	*
WS Max WS - TR030_36_0	x
WS Max WS - TR030_12_0	.
WS Max WS - TR030_09_0	o
WS Max WS - TR030_03_0	x
WS Max WS - TR030_06_0	■
WS Max WS - TR030_01_5	▼
WS Max WS - TR030_01_0	▲
WS Max WS - TR030_00_5	■
Ground	■
Levee	□
Bank Sta	●

Studio Scandicci Torrenti Greve-Vingone
River = Fosso Stagnolo Reach = Stagnolo RS = 70 ST0021_C

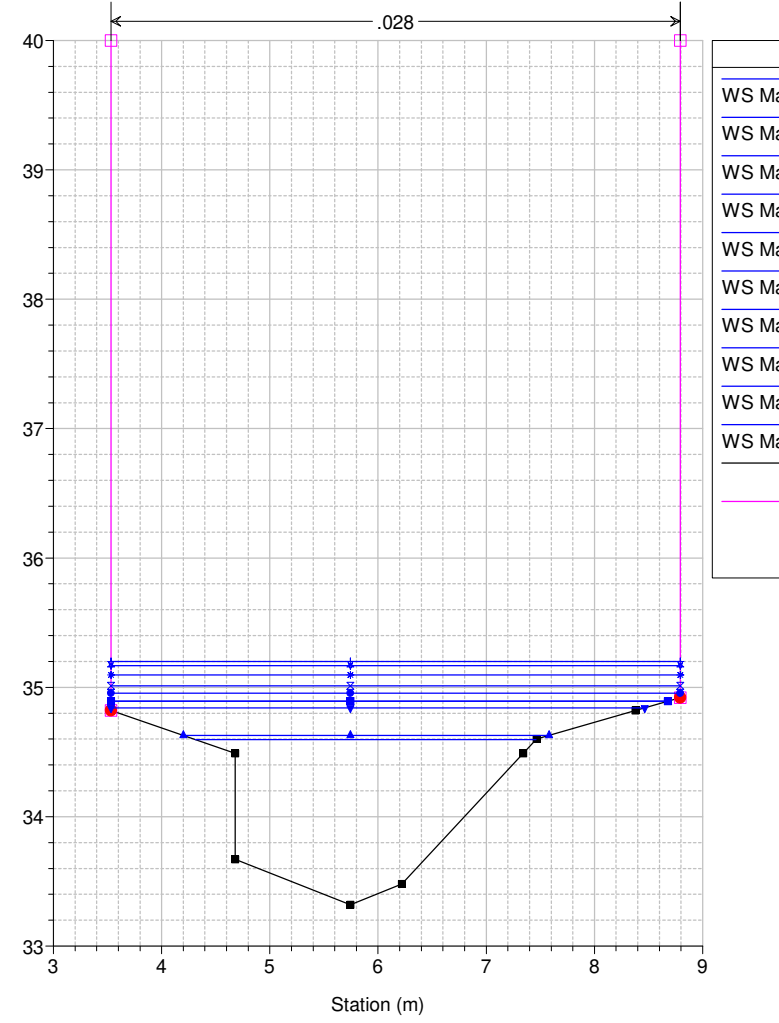

Legend	
WS Max WS - TR030_18_0	+
WS Max WS - TR030_24_0	*
WS Max WS - TR030_36_0	x
WS Max WS - TR030_12_0	.
WS Max WS - TR030_09_0	o
WS Max WS - TR030_03_0	x
WS Max WS - TR030_06_0	■
WS Max WS - TR030_01_5	▼
WS Max WS - TR030_01_0	▲
WS Max WS - TR030_00_5	■
Ground	■
Levee	□
Bank Sta	●

Studio Scandicci Torrenti Greve-Vingone
River = Fosso Stagnolo Reach = Stagnolo RS = 69 ST0021_D

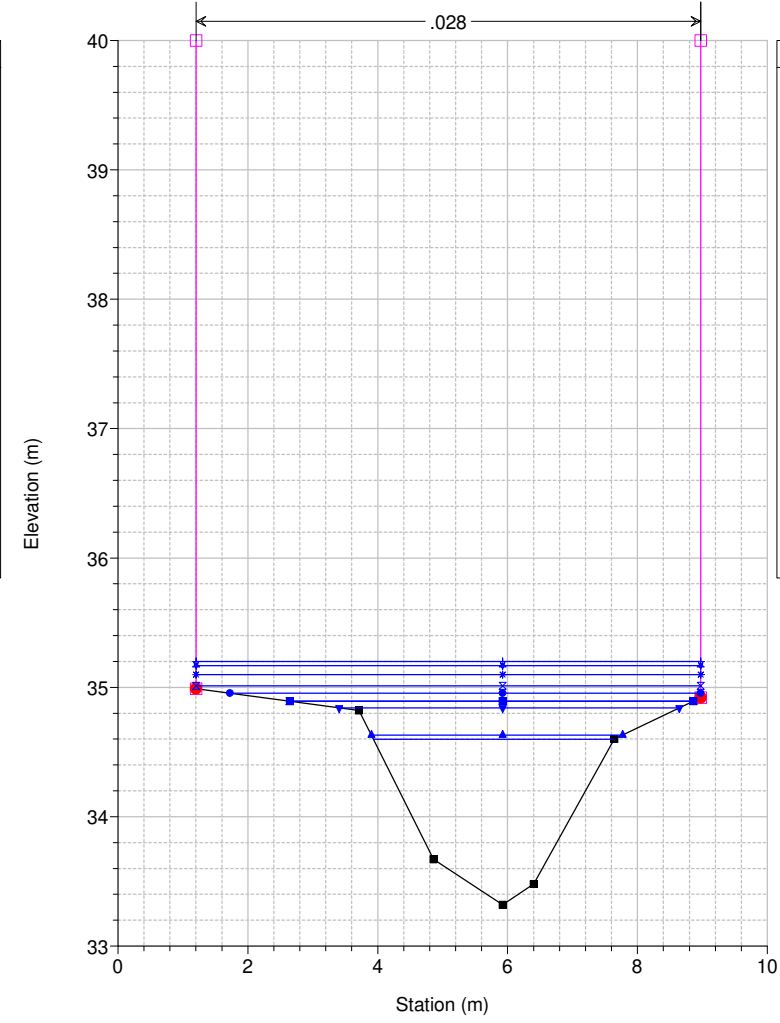

Legend	
WS Max WS - TR030_18_0	+
WS Max WS - TR030_24_0	*
WS Max WS - TR030_36_0	x
WS Max WS - TR030_12_0	.
WS Max WS - TR030_09_0	o
WS Max WS - TR030_03_0	x
WS Max WS - TR030_06_0	■
WS Max WS - TR030_01_5	▼
WS Max WS - TR030_01_0	▲
WS Max WS - TR030_00_5	■
Ground	■
Levee	□
Bank Sta	●

Studio Scandicci Torrenti Greve-Vingone
River = Fosso Stagnolo Reach = Stagnolo RS = 68 ST0022_

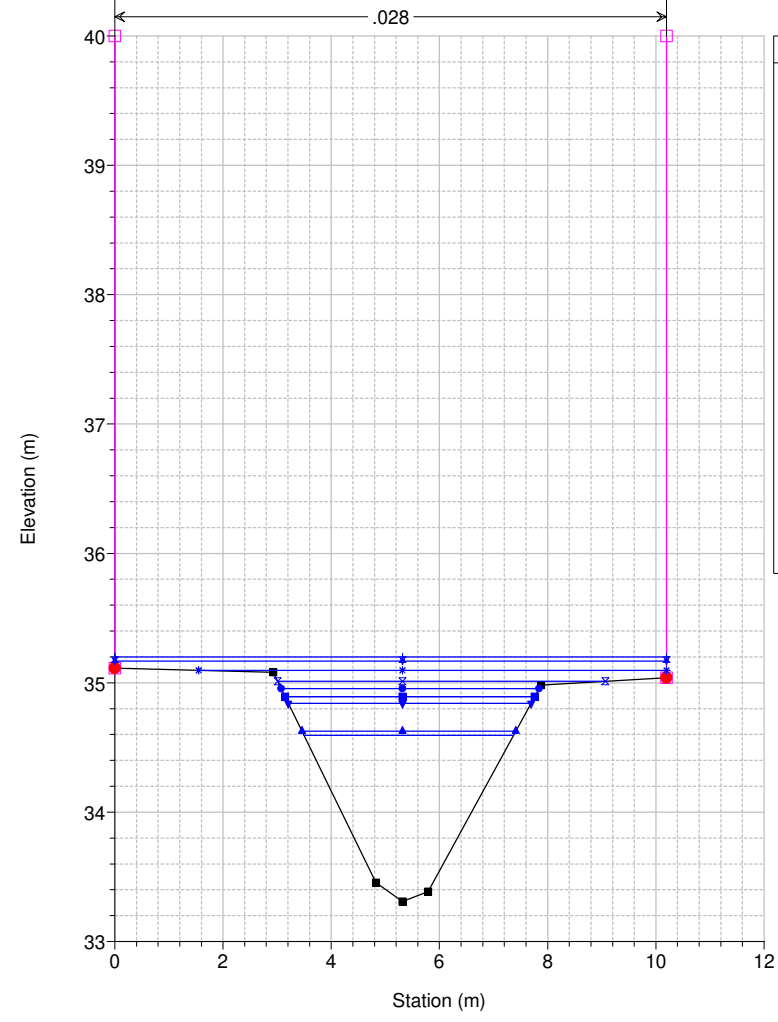

Legend	
WS Max WS - TR030_18_0	+
WS Max WS - TR030_24_0	*
WS Max WS - TR030_36_0	x
WS Max WS - TR030_12_0	.
WS Max WS - TR030_09_0	o
WS Max WS - TR030_03_0	x
WS Max WS - TR030_06_0	■
WS Max WS - TR030_01_5	▼
WS Max WS - TR030_01_0	▲
WS Max WS - TR030_00_5	■
Ground	■
Levee	□
Bank Sta	●

Studio Scandicci Torrenti Greve-Vingone
River = Fosso Stagnolo Reach = Stagnolo RS = 67 ST0023_

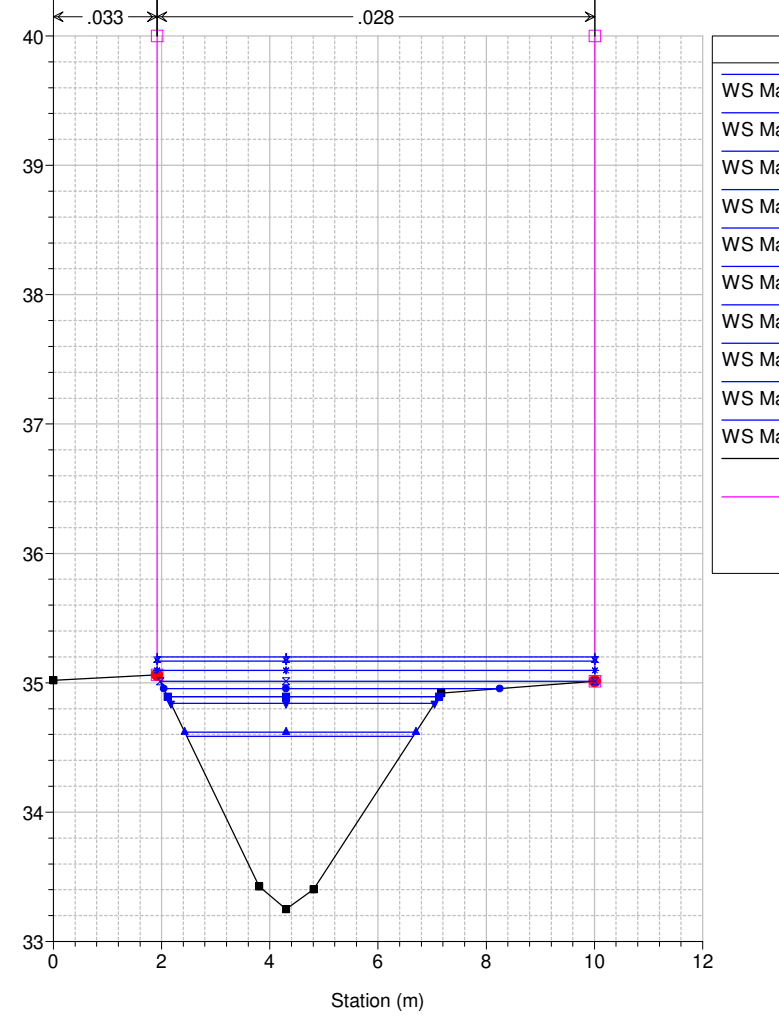

Legend	
WS Max WS - TR030_18_0	+
WS Max WS - TR030_24_0	*
WS Max WS - TR030_36_0	x
WS Max WS - TR030_12_0	.
WS Max WS - TR030_09_0	o
WS Max WS - TR030_03_0	x
WS Max WS - TR030_06_0	■
WS Max WS - TR030_01_5	▼
WS Max WS - TR030_01_0	▲
WS Max WS - TR030_00_5	■
Ground	■
Levee	□
Bank Sta	●

Studio Scandicci Torrenti Greve-Vingone
River = Fosso Stagnolo Reach = Stagnolo RS = 66 ST0024_

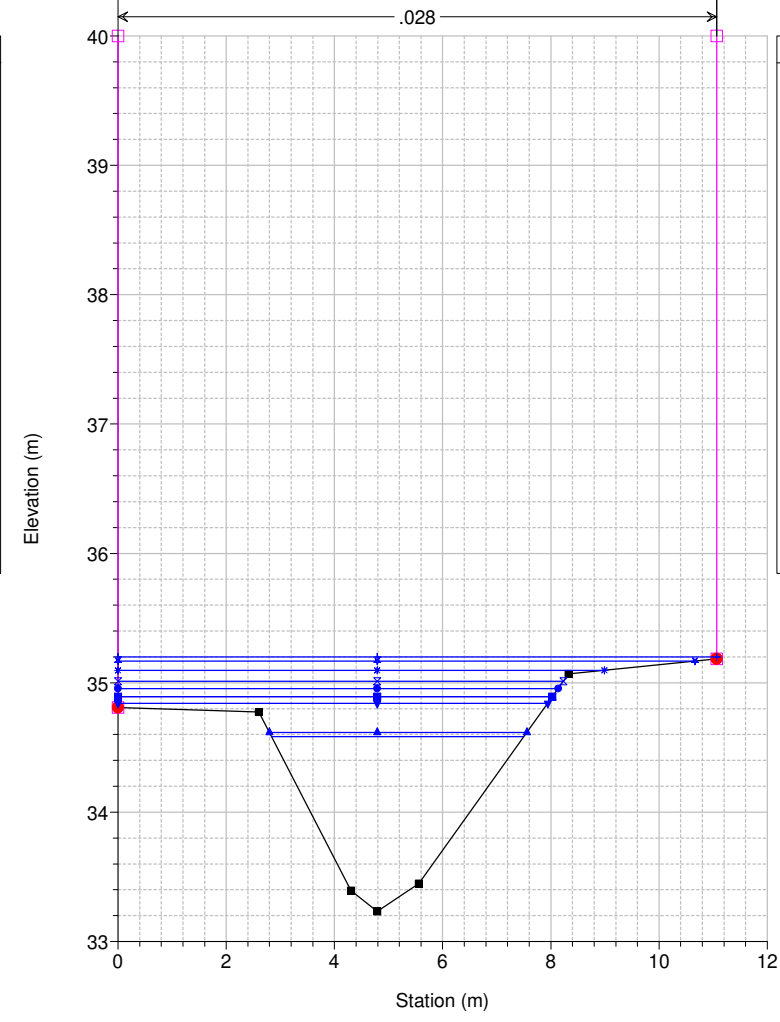

Legend	
WS Max WS - TR030_18_0	+
WS Max WS - TR030_24_0	*
WS Max WS - TR030_36_0	x
WS Max WS - TR030_12_0	.
WS Max WS - TR030_09_0	o
WS Max WS - TR030_03_0	x
WS Max WS - TR030_06_0	■
WS Max WS - TR030_01_5	▼
WS Max WS - TR030_01_0	▲
WS Max WS - TR030_00_5	■
Ground	■
Levee	□
Bank Sta	●

Studio Scandicci Torrenti Greve-Vingone
River = Fosso Stagnolo Reach = Stagnolo RS = 65 ST0025_

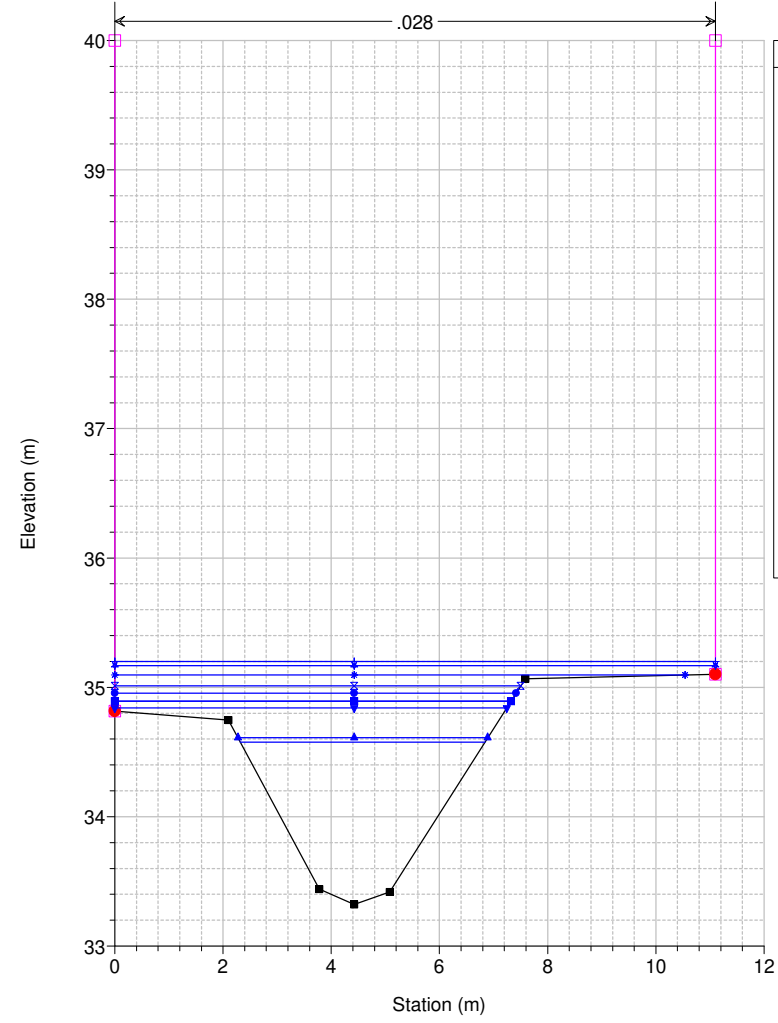

Legend	
WS Max WS - TR030_18_0	+
WS Max WS - TR030_24_0	*
WS Max WS - TR030_36_0	o
WS Max WS - TR030_12_0	x
WS Max WS - TR030_09_0	•
WS Max WS - TR030_03_0	x
WS Max WS - TR030_06_0	■
WS Max WS - TR030_01_5	▼
WS Max WS - TR030_01_0	▲
WS Max WS - TR030_00_5	■
Ground	■
Levee	□
Bank Sta	●

Studio Scandicci Torrenti Greve-Vingone
River = Fosso Stagnolo Reach = Stagnolo RS = 64 ST0026_

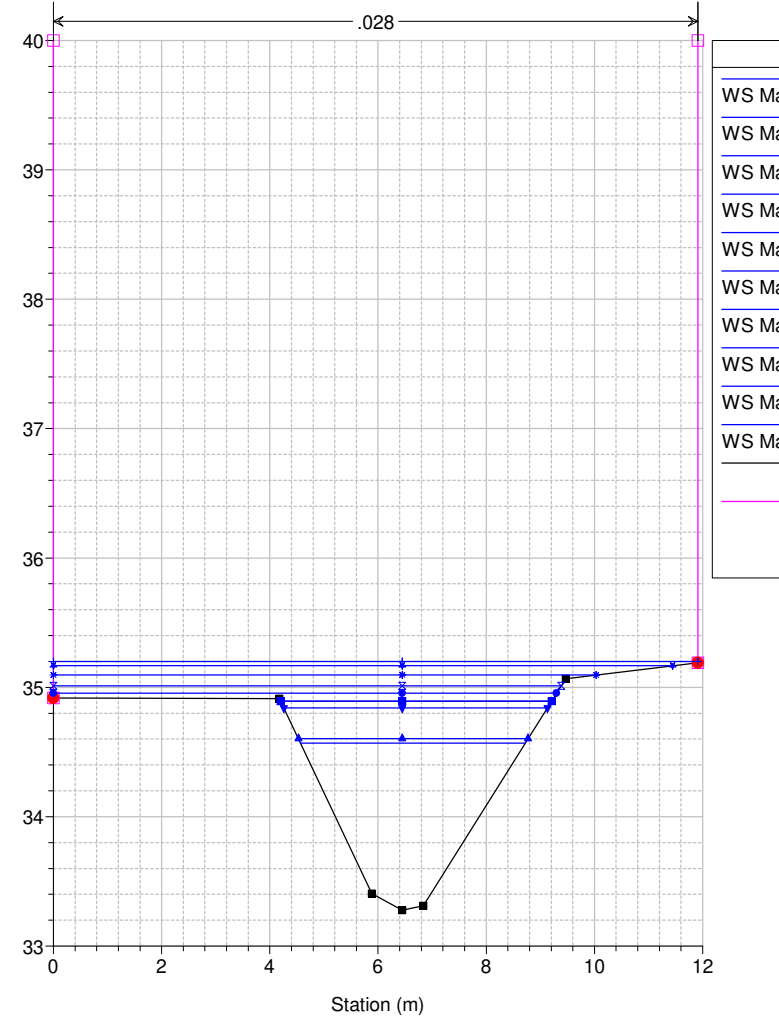

Legend	
WS Max WS - TR030_18_0	+
WS Max WS - TR030_24_0	*
WS Max WS - TR030_36_0	o
WS Max WS - TR030_12_0	x
WS Max WS - TR030_09_0	•
WS Max WS - TR030_03_0	x
WS Max WS - TR030_06_0	■
WS Max WS - TR030_01_5	▼
WS Max WS - TR030_01_0	▲
WS Max WS - TR030_00_5	■
Ground	■
Levee	□
Bank Sta	●

Studio Scandicci Torrenti Greve-Vingone
River = Fosso Stagnolo Reach = Stagnolo RS = 63 ST0027_A

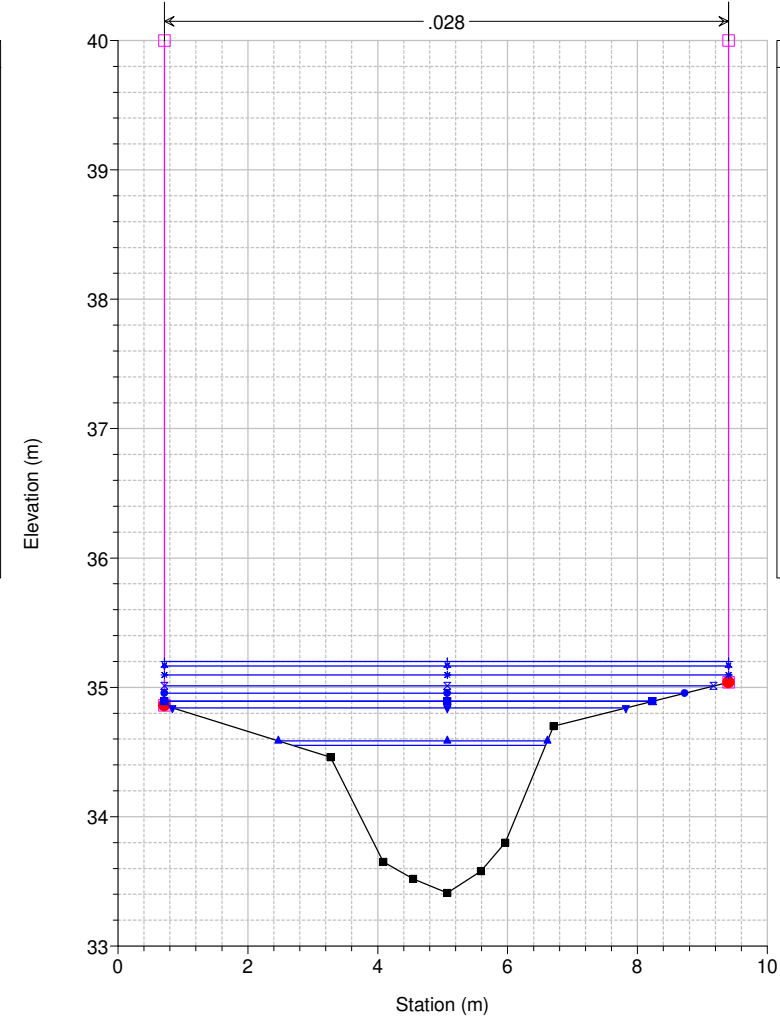

Legend	
WS Max WS - TR030_18_0	+
WS Max WS - TR030_24_0	*
WS Max WS - TR030_36_0	o
WS Max WS - TR030_12_0	x
WS Max WS - TR030_09_0	•
WS Max WS - TR030_03_0	x
WS Max WS - TR030_06_0	■
WS Max WS - TR030_01_5	▼
WS Max WS - TR030_01_0	▲
WS Max WS - TR030_00_5	■
Ground	■
Levee	□
Bank Sta	●

Studio Scandicci Torrenti Greve-Vingone
River = Fosso Stagnolo Reach = Stagnolo RS = 62 ST0027_B

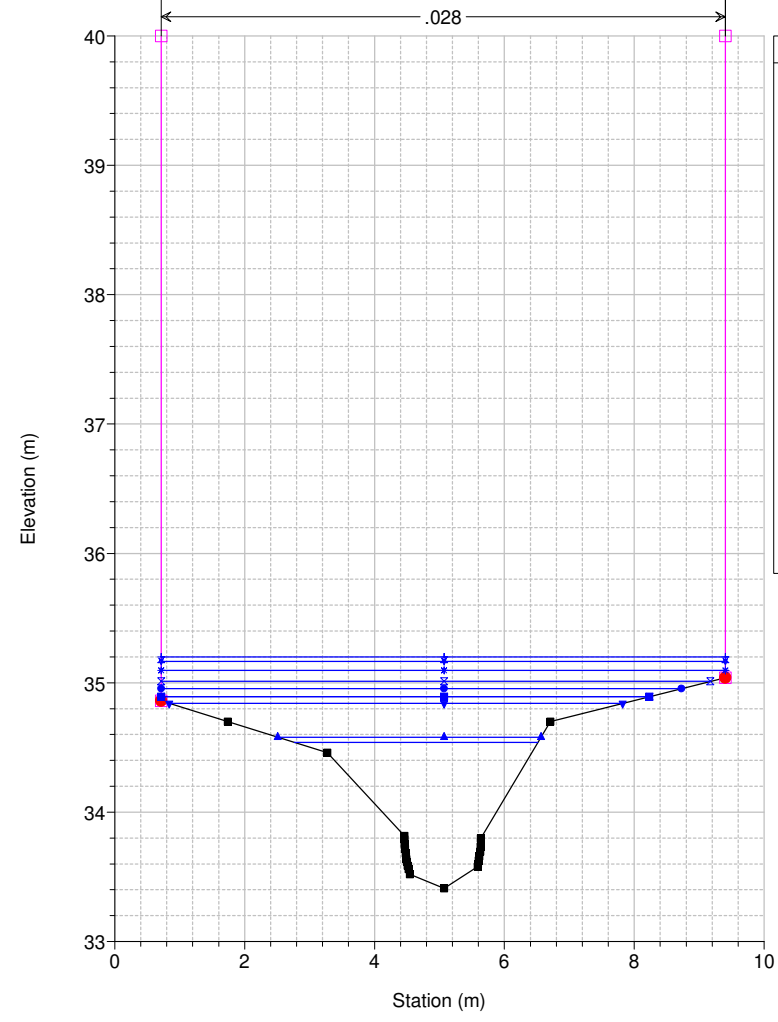

Legend	
WS Max WS - TR030_18_0	+
WS Max WS - TR030_24_0	*
WS Max WS - TR030_36_0	o
WS Max WS - TR030_12_0	x
WS Max WS - TR030_09_0	•
WS Max WS - TR030_03_0	x
WS Max WS - TR030_06_0	■
WS Max WS - TR030_01_5	▼
WS Max WS - TR030_01_0	▲
WS Max WS - TR030_00_5	■
Ground	■
Levee	□
Bank Sta	●

Studio Scandicci Torrenti Greve-Vingone
River = Fosso Stagnolo Reach = Stagnolo RS = 61.5 BR

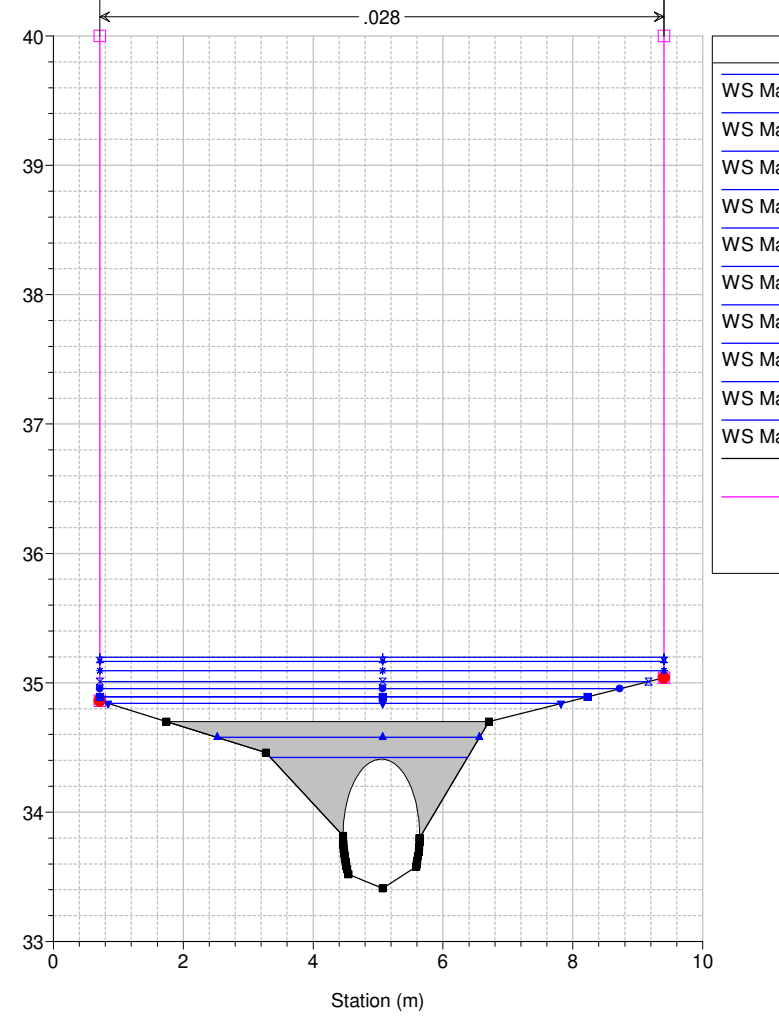

Legend	
WS Max WS - TR030_18_0	+
WS Max WS - TR030_24_0	*
WS Max WS - TR030_36_0	o
WS Max WS - TR030_12_0	x
WS Max WS - TR030_09_0	•
WS Max WS - TR030_03_0	x
WS Max WS - TR030_06_0	■
WS Max WS - TR030_01_5	▼
WS Max WS - TR030_01_0	▲
WS Max WS - TR030_00_5	■
Ground	■
Levee	□
Bank Sta	●

Studio Scandicci Torrenti Greve-Vingone
River = Fosso Stagnolo Reach = Stagnolo RS = 61.5 BR

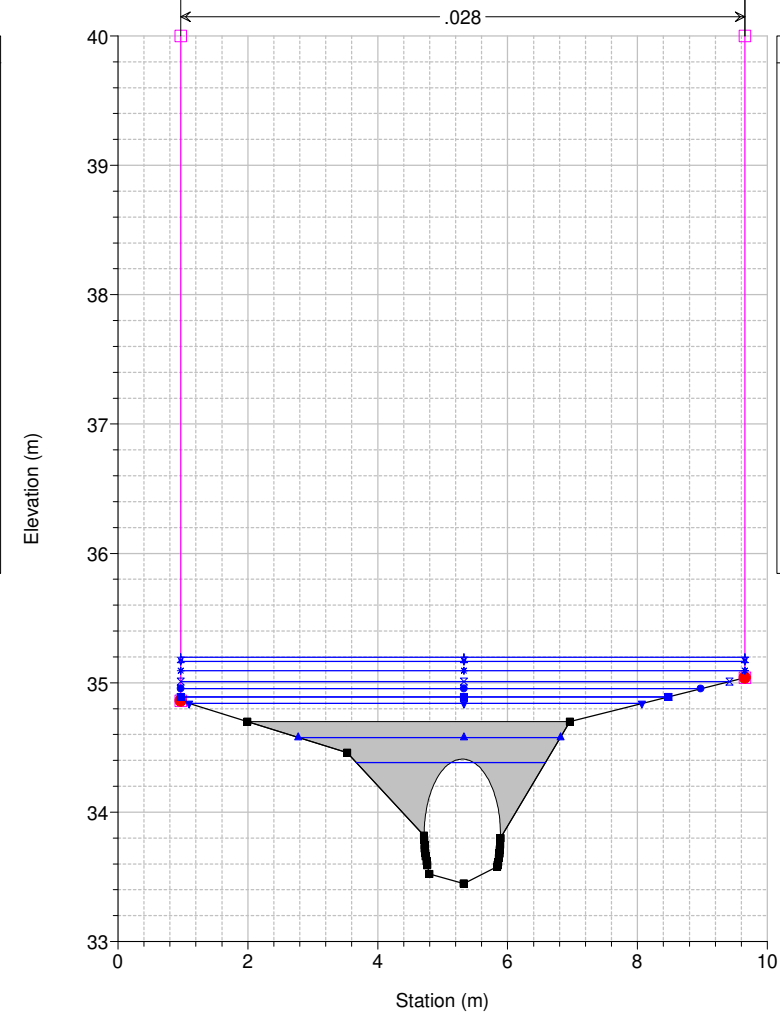

Legend	
WS Max WS - TR030_18_0	+
WS Max WS - TR030_24_0	*
WS Max WS - TR030_36_0	o
WS Max WS - TR030_12_0	x
WS Max WS - TR030_09_0	•
WS Max WS - TR030_03_0	x
WS Max WS - TR030_06_0	■
WS Max WS - TR030_01_5	▼
WS Max WS - TR030_01_0	▲
WS Max WS - TR030_00_5	■
Ground	■
Levee	□
Bank Sta	●

Studio Scandicci Torrenti Greve-Vingone
River = Fosso Stagnolo Reach = Stagnolo RS = 61 ST0027_C

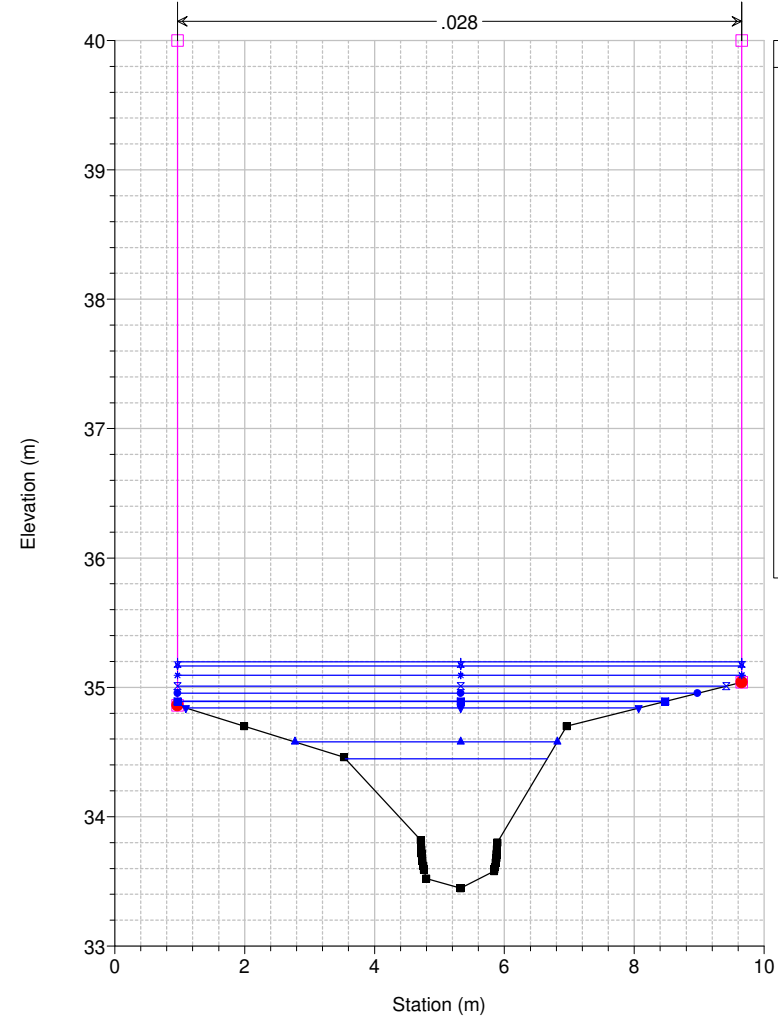

Legend

- WS Max WS - TR030_18_0
- WS Max WS - TR030_24_0
- WS Max WS - TR030_36_0
- WS Max WS - TR030_12_0
- WS Max WS - TR030_09_0
- WS Max WS - TR030_03_0
- WS Max WS - TR030_06_0
- WS Max WS - TR030_01_5
- WS Max WS - TR030_01_0
- WS Max WS - TR030_00_5
- Ground
- Levee
- Bank Sta

Studio Scandicci Torrenti Greve-Vingone
River = Fosso Stagnolo Reach = Stagnolo RS = 60 ST0027_D

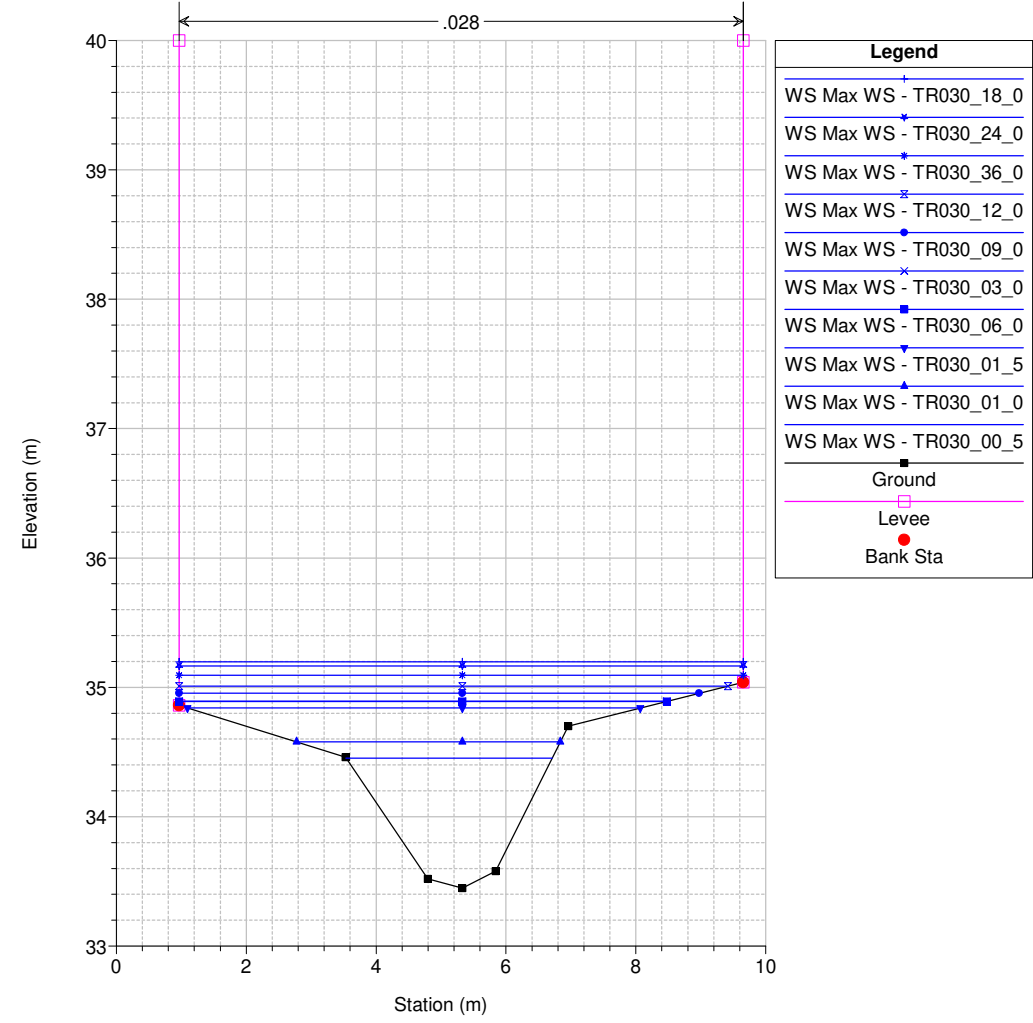

Legend

- WS Max WS - TR030_18_0
- WS Max WS - TR030_24_0
- WS Max WS - TR030_36_0
- WS Max WS - TR030_12_0
- WS Max WS - TR030_09_0
- WS Max WS - TR030_03_0
- WS Max WS - TR030_06_0
- WS Max WS - TR030_01_5
- WS Max WS - TR030_01_0
- WS Max WS - TR030_00_5
- Ground
- Levee
- Bank Sta

Studio Scandicci Torrenti Greve-Vingone
River = Fosso Stagnolo Reach = Stagnolo RS = 59 ST0028__

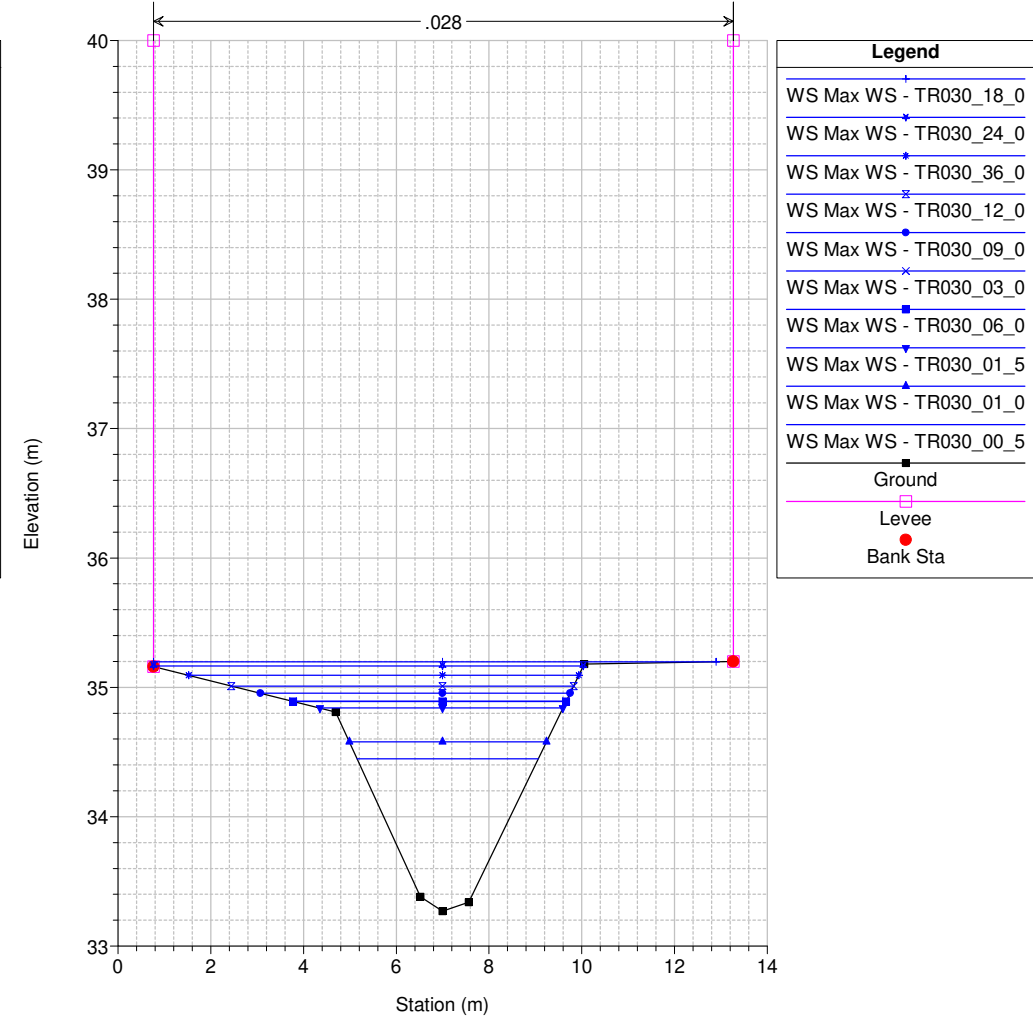

Legend

- WS Max WS - TR030_18_0
- WS Max WS - TR030_24_0
- WS Max WS - TR030_36_0
- WS Max WS - TR030_12_0
- WS Max WS - TR030_09_0
- WS Max WS - TR030_03_0
- WS Max WS - TR030_06_0
- WS Max WS - TR030_01_5
- WS Max WS - TR030_01_0
- WS Max WS - TR030_00_5
- Ground
- Levee
- Bank Sta

Studio Scandicci Torrenti Greve-Vingone
River = Fosso Stagnolo Reach = Stagnolo RS = 58 ST0029__

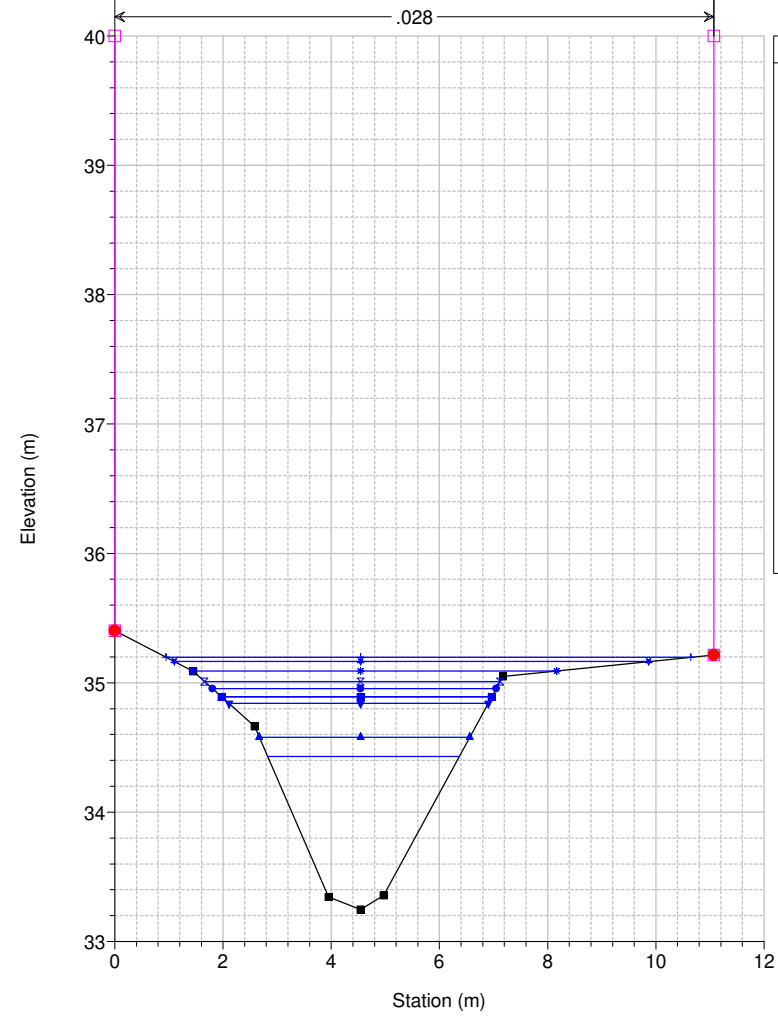

Legend

- WS Max WS - TR030_18_0
- WS Max WS - TR030_24_0
- WS Max WS - TR030_36_0
- WS Max WS - TR030_12_0
- WS Max WS - TR030_09_0
- WS Max WS - TR030_03_0
- WS Max WS - TR030_06_0
- WS Max WS - TR030_01_5
- WS Max WS - TR030_01_0
- WS Max WS - TR030_00_5
- Ground
- Levee
- Bank Sta

Studio Scandicci Torrenti Greve-Vingone
River = Fosso Stagnolo Reach = Stagnolo RS = 57 ST0030__

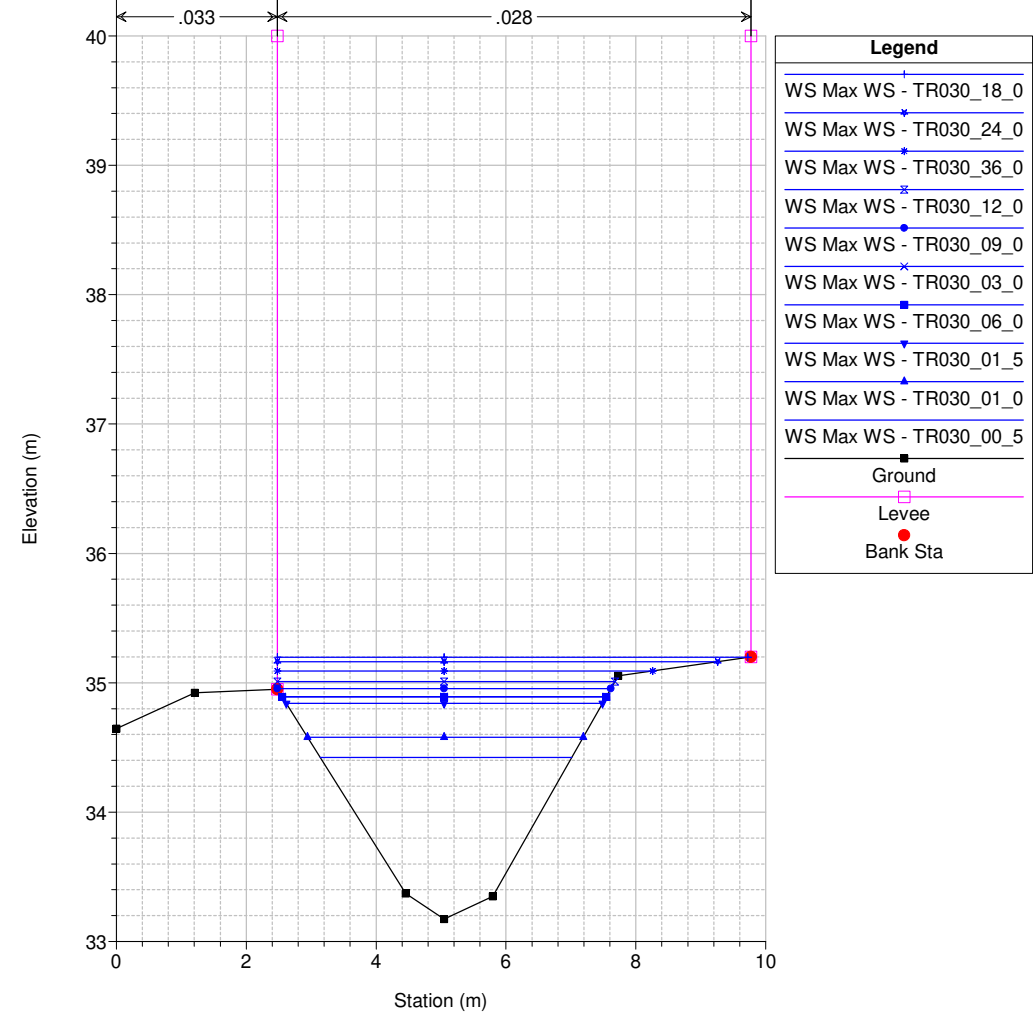

Legend

- WS Max WS - TR030_18_0
- WS Max WS - TR030_24_0
- WS Max WS - TR030_36_0
- WS Max WS - TR030_12_0
- WS Max WS - TR030_09_0
- WS Max WS - TR030_03_0
- WS Max WS - TR030_06_0
- WS Max WS - TR030_01_5
- WS Max WS - TR030_01_0
- WS Max WS - TR030_00_5
- Ground
- Levee
- Bank Sta

Studio Scandicci Torrenti Greve-Vingone
River = Fosso Stagnolo Reach = Stagnolo RS = 56 ST0031__

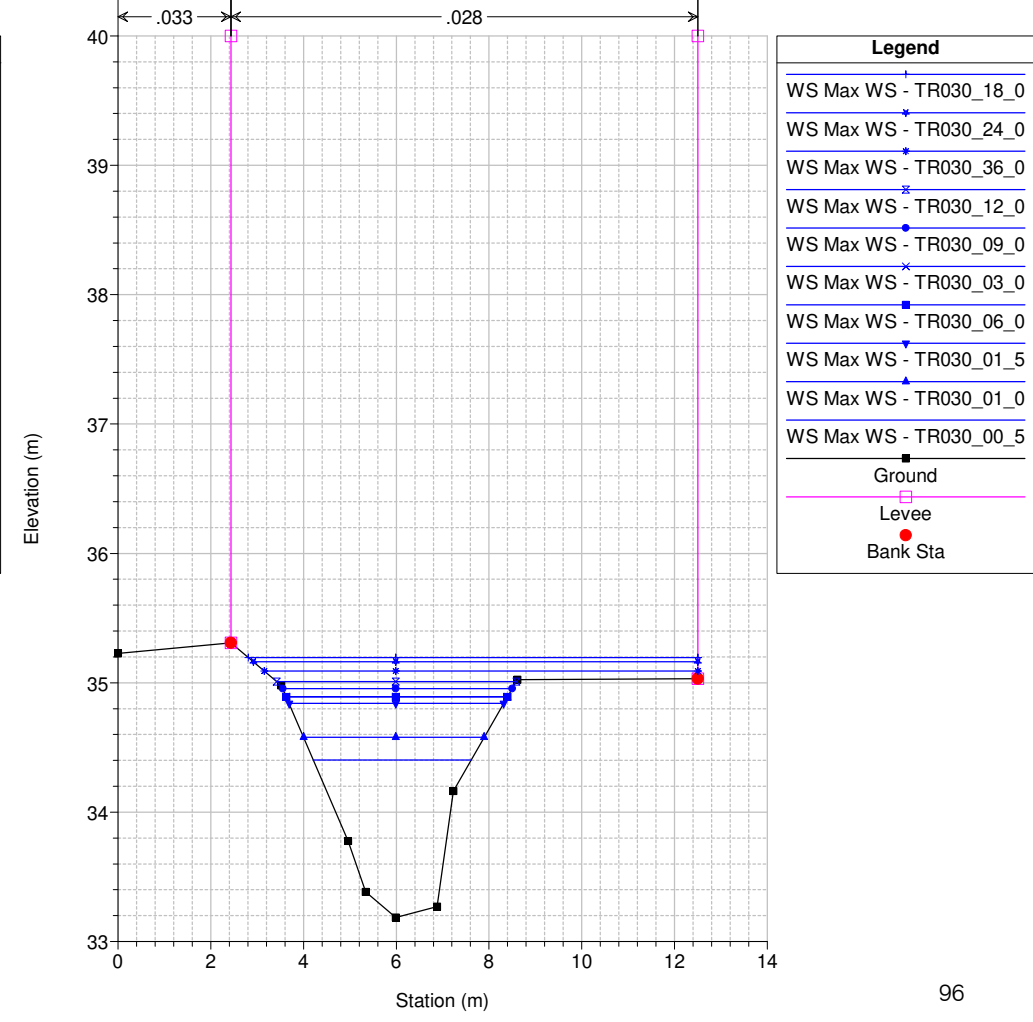

Legend

- WS Max WS - TR030_18_0
- WS Max WS - TR030_24_0
- WS Max WS - TR030_36_0
- WS Max WS - TR030_12_0
- WS Max WS - TR030_09_0
- WS Max WS - TR030_03_0
- WS Max WS - TR030_06_0
- WS Max WS - TR030_01_5
- WS Max WS - TR030_01_0
- WS Max WS - TR030_00_5
- Ground
- Levee
- Bank Sta

Studio Scandicci Torrenti Greve-Vingone
River = Fosso Stagnolo Reach = Stagnolo RS = 55 ST0032__

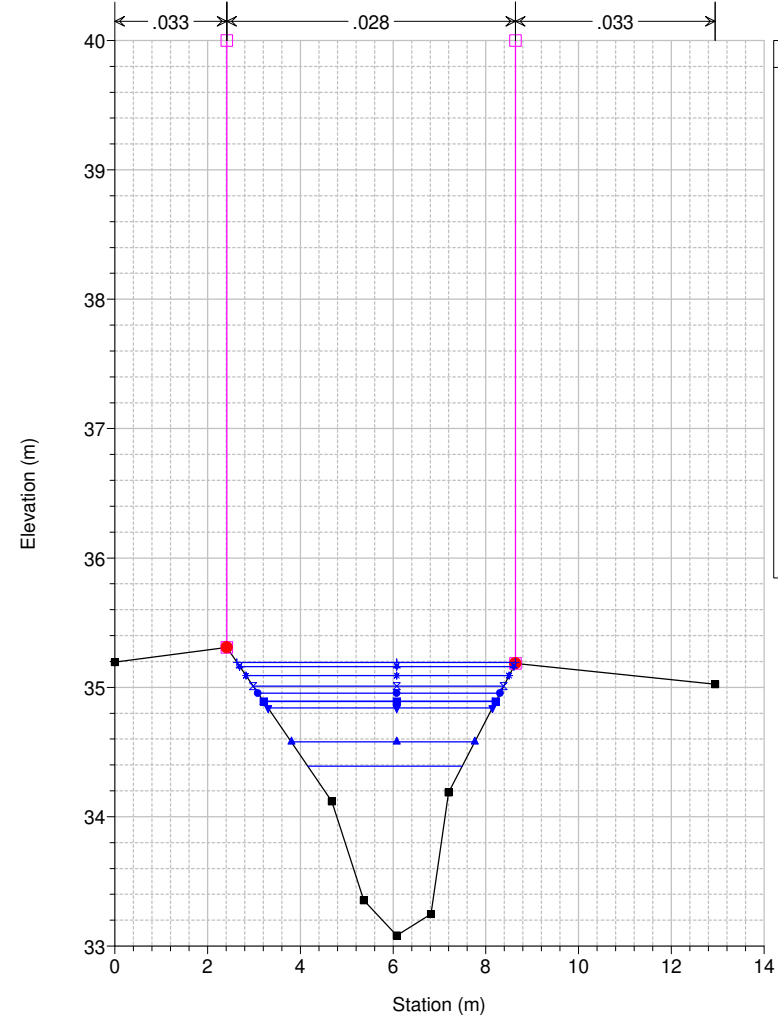

Legend	
WS Max WS - TR030_18_0	+
WS Max WS - TR030_24_0	*
WS Max WS - TR030_36_0	•
WS Max WS - TR030_12_0	x
WS Max WS - TR030_09_0	•
WS Max WS - TR030_03_0	x
WS Max WS - TR030_06_0	■
WS Max WS - TR030_01_5	▼
WS Max WS - TR030_01_0	▲
WS Max WS - TR030_00_5	■
Ground	■
Levee	□
Bank Sta	•

Studio Scandicci Torrenti Greve-Vingone
River = Fosso Stagnolo Reach = Stagnolo RS = 54 ST0033__

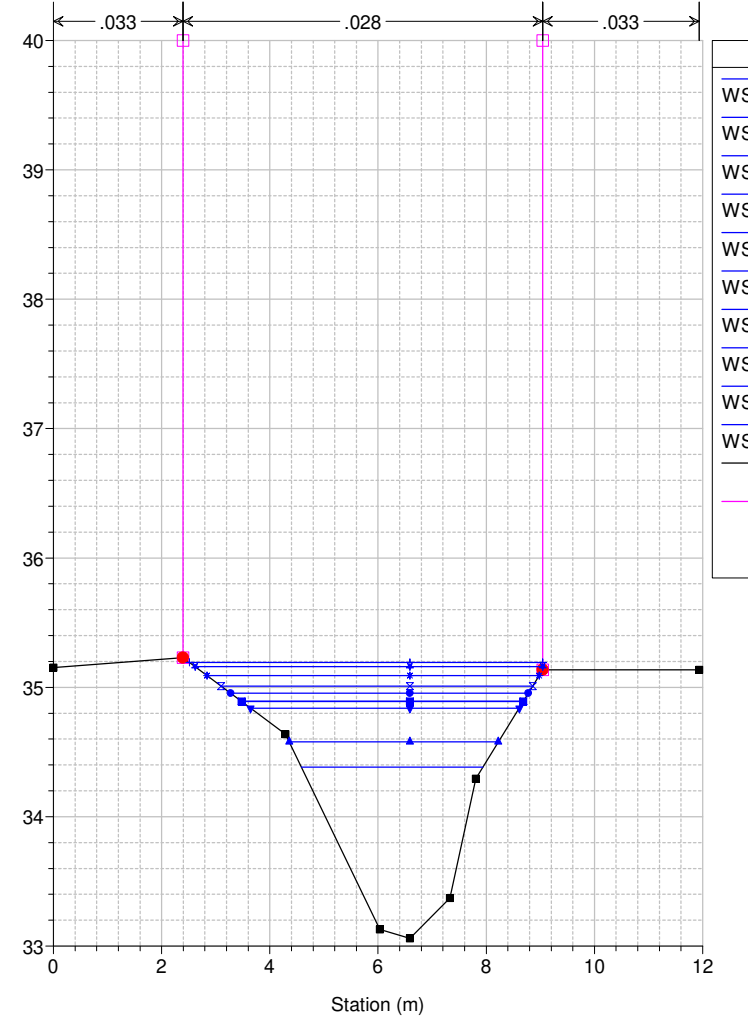

Legend	
WS Max WS - TR030_18_0	+
WS Max WS - TR030_24_0	*
WS Max WS - TR030_36_0	•
WS Max WS - TR030_12_0	x
WS Max WS - TR030_09_0	•
WS Max WS - TR030_03_0	x
WS Max WS - TR030_06_0	■
WS Max WS - TR030_01_5	▼
WS Max WS - TR030_01_0	▲
WS Max WS - TR030_00_5	■
Ground	■
Levee	□
Bank Sta	•

Studio Scandicci Torrenti Greve-Vingone
River = Fosso Stagnolo Reach = Stagnolo RS = 53 ST0034__

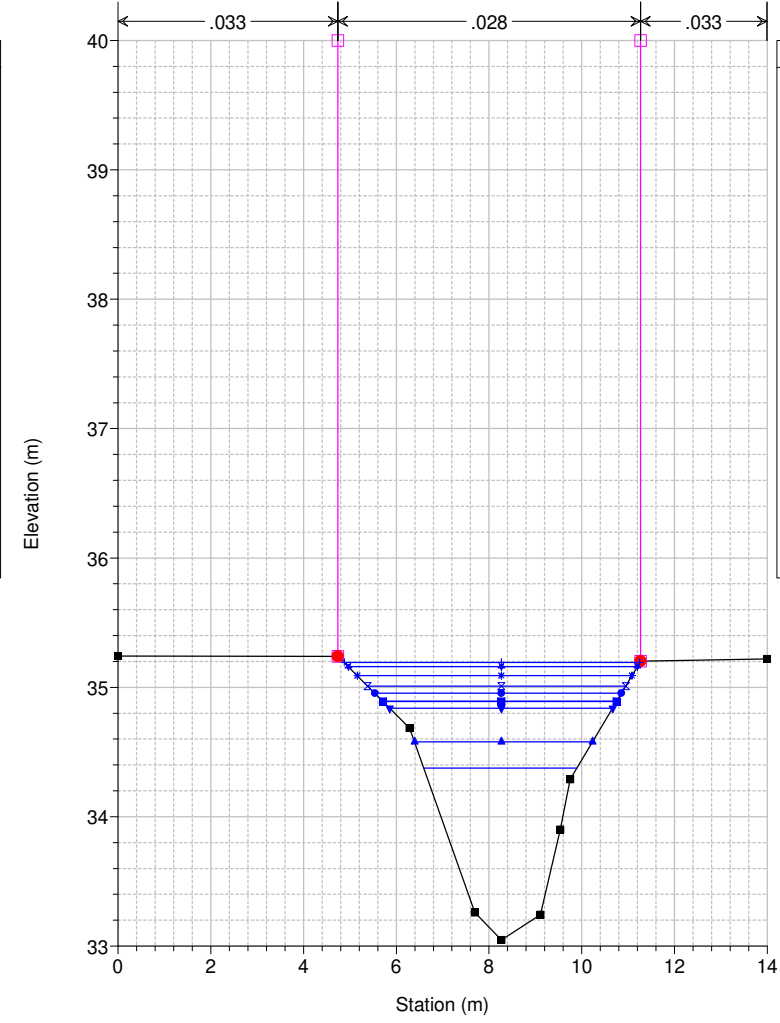

Legend	
WS Max WS - TR030_18_0	+
WS Max WS - TR030_24_0	*
WS Max WS - TR030_36_0	•
WS Max WS - TR030_12_0	x
WS Max WS - TR030_09_0	•
WS Max WS - TR030_03_0	x
WS Max WS - TR030_06_0	■
WS Max WS - TR030_01_5	▼
WS Max WS - TR030_01_0	▲
WS Max WS - TR030_00_5	■
Ground	■
Levee	□
Bank Sta	•

Studio Scandicci Torrenti Greve-Vingone
River = Fosso Stagnolo Reach = Stagnolo RS = 52 ST0035__

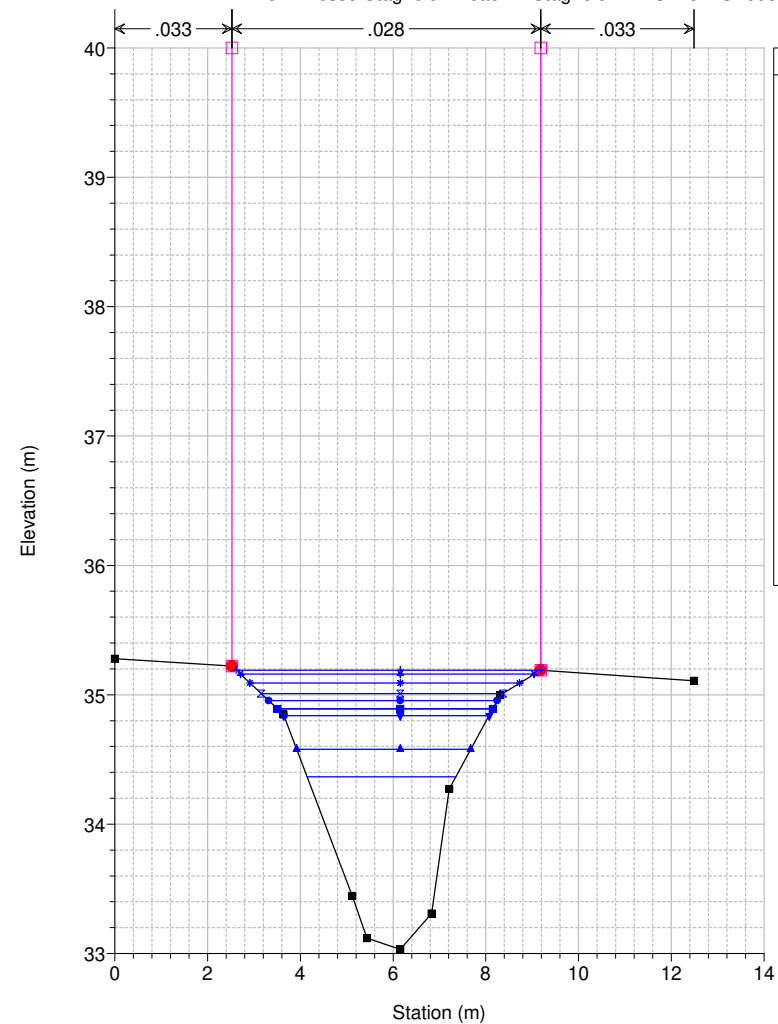

Legend	
WS Max WS - TR030_18_0	+
WS Max WS - TR030_24_0	*
WS Max WS - TR030_36_0	•
WS Max WS - TR030_12_0	x
WS Max WS - TR030_09_0	•
WS Max WS - TR030_03_0	x
WS Max WS - TR030_06_0	■
WS Max WS - TR030_01_5	▼
WS Max WS - TR030_01_0	▲
WS Max WS - TR030_00_5	■
Ground	■
Levee	□
Bank Sta	•

Studio Scandicci Torrenti Greve-Vingone
River = Fosso Stagnolo Reach = Stagnolo RS = 51 ST0036__

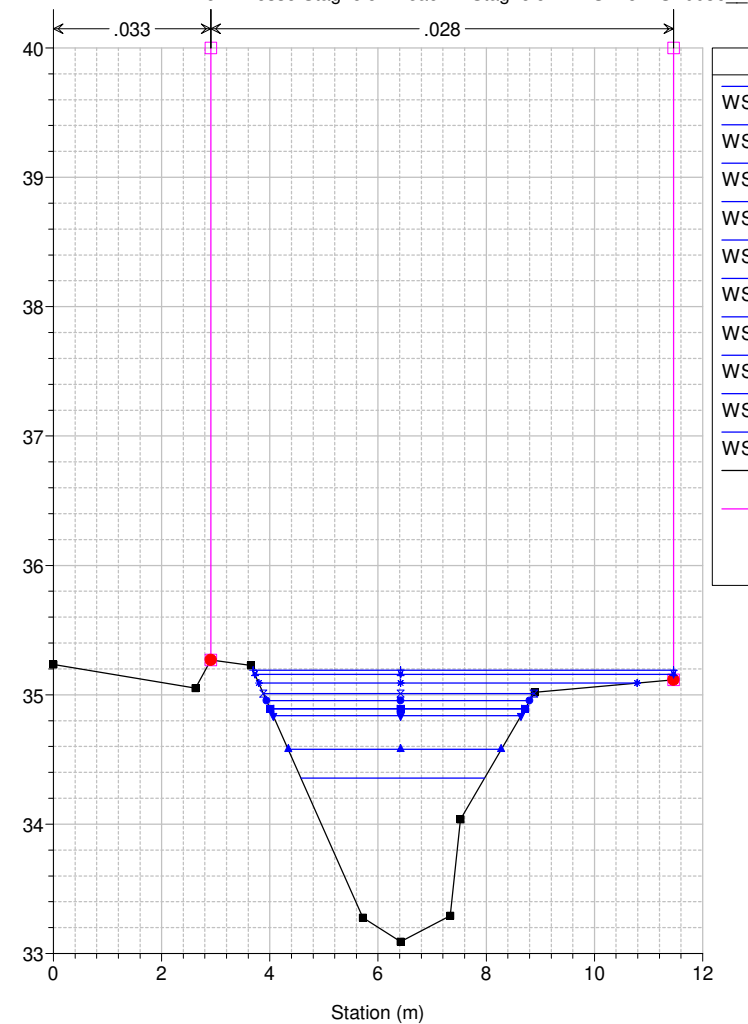

Legend	
WS Max WS - TR030_18_0	+
WS Max WS - TR030_24_0	*
WS Max WS - TR030_36_0	•
WS Max WS - TR030_12_0	x
WS Max WS - TR030_09_0	•
WS Max WS - TR030_03_0	x
WS Max WS - TR030_06_0	■
WS Max WS - TR030_01_5	▼
WS Max WS - TR030_01_0	▲
WS Max WS - TR030_00_5	■
Ground	■
Levee	□
Bank Sta	•

Studio Scandicci Torrenti Greve-Vingone
River = Fosso Stagnolo Reach = Stagnolo RS = 50 ST0037_A

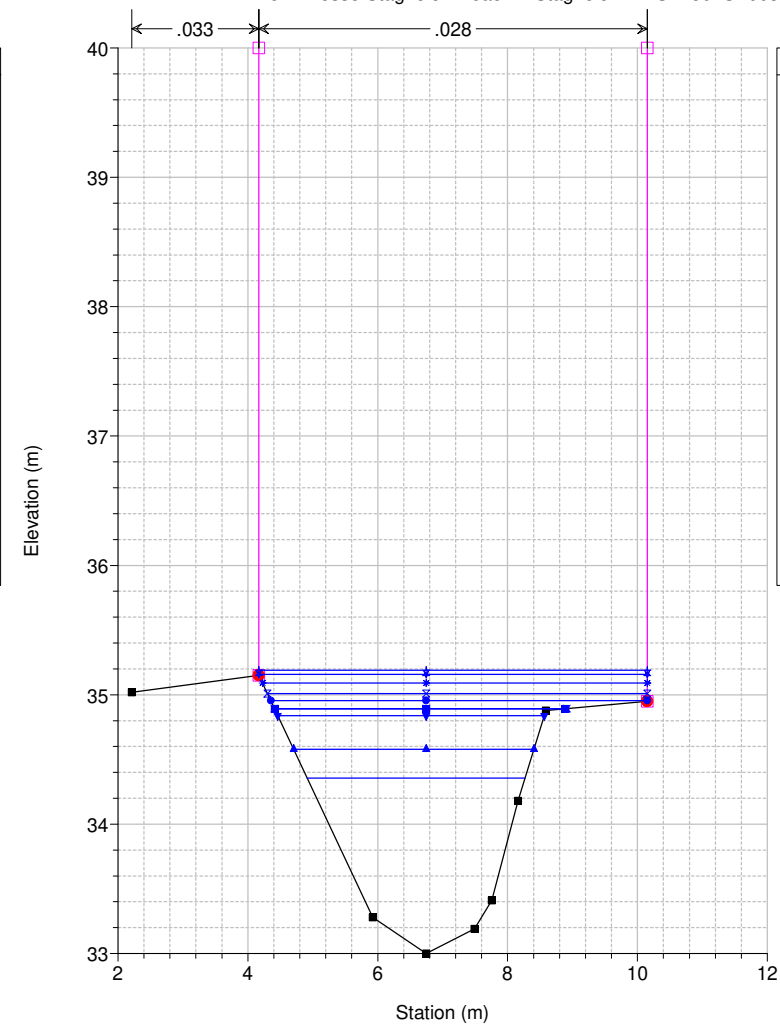

Legend	
WS Max WS - TR030_18_0	+
WS Max WS - TR030_24_0	*
WS Max WS - TR030_36_0	•
WS Max WS - TR030_12_0	x
WS Max WS - TR030_09_0	•
WS Max WS - TR030_03_0	x
WS Max WS - TR030_06_0	■
WS Max WS - TR030_01_5	▼
WS Max WS - TR030_01_0	▲
WS Max WS - TR030_00_5	■
Ground	■
Levee	□
Bank Sta	•

Studio Scandicci Torrenti Greve-Vingone
River = Fosso Stagnolo Reach = Stagnolo RS = 49 ST0037_B

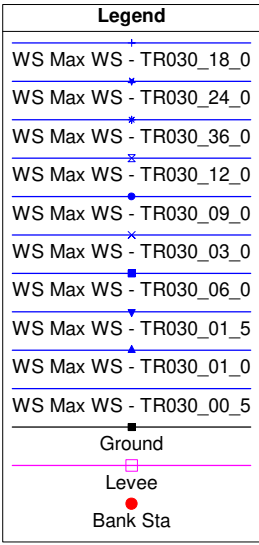
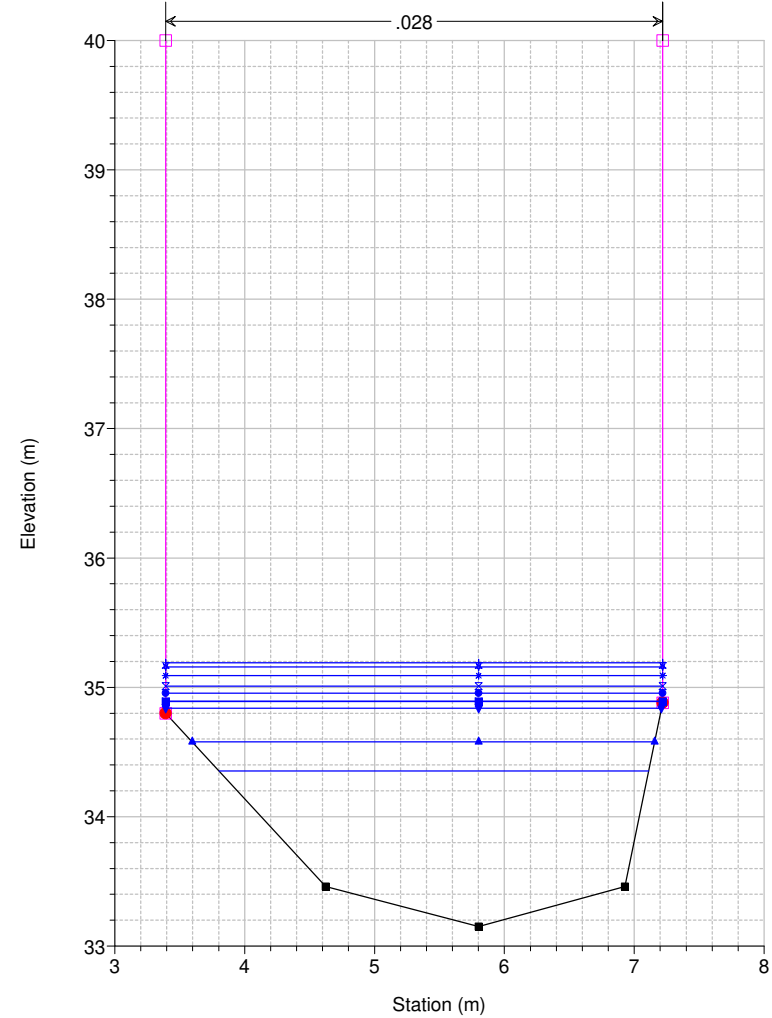

Studio Scandicci Torrenti Greve-Vingone
River = Fosso Stagnolo Reach = Stagnolo RS = 48.5 BR

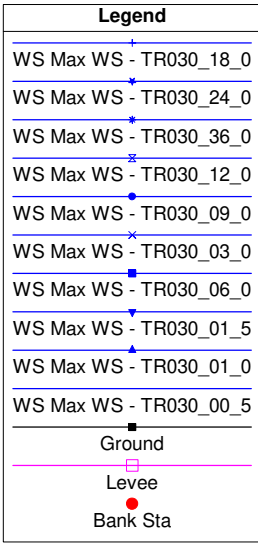
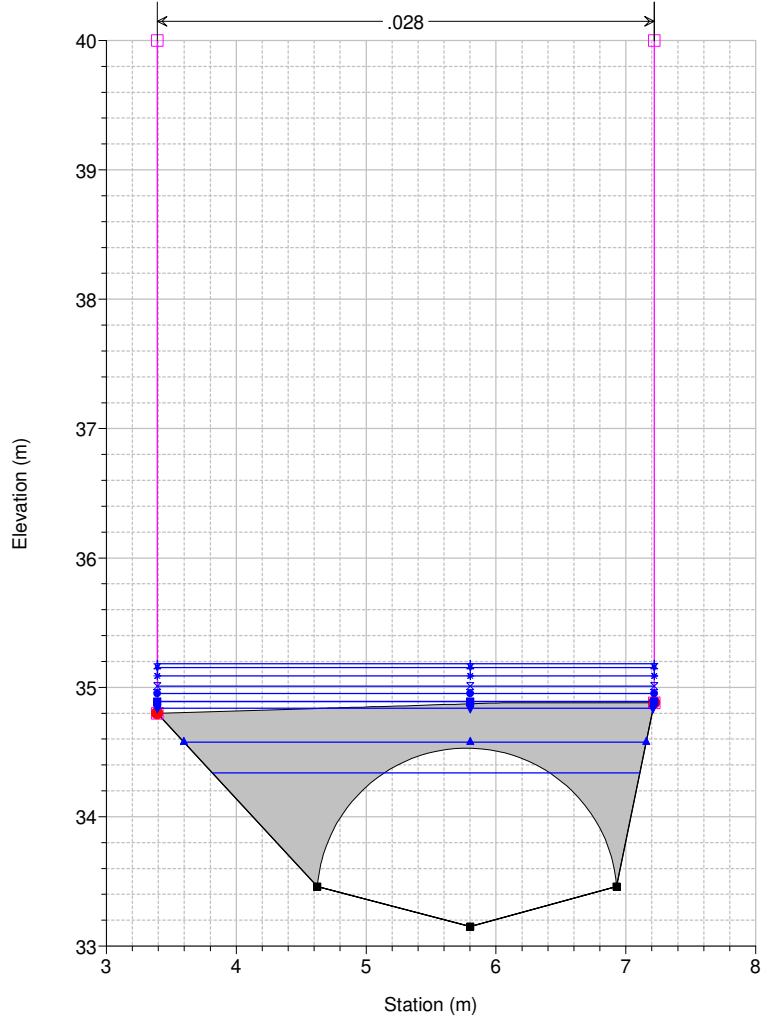

Studio Scandicci Torrenti Greve-Vingone
River = Fosso Stagnolo Reach = Stagnolo RS = 48.5 BR

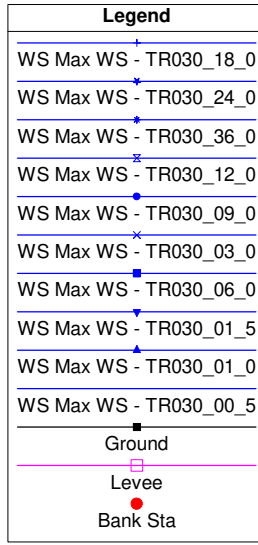
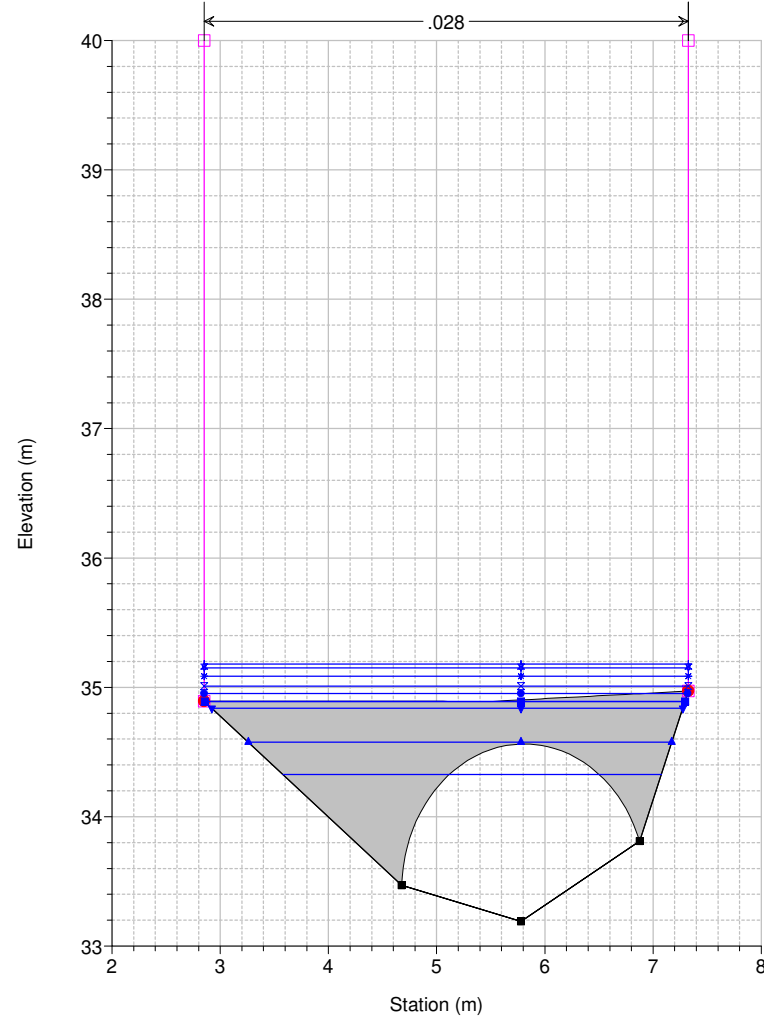

Studio Scandicci Torrenti Greve-Vingone
River = Fosso Stagnolo Reach = Stagnolo RS = 48 ST0037_C

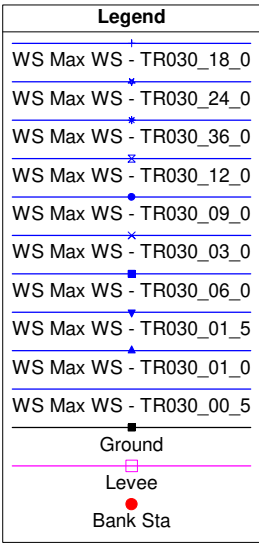
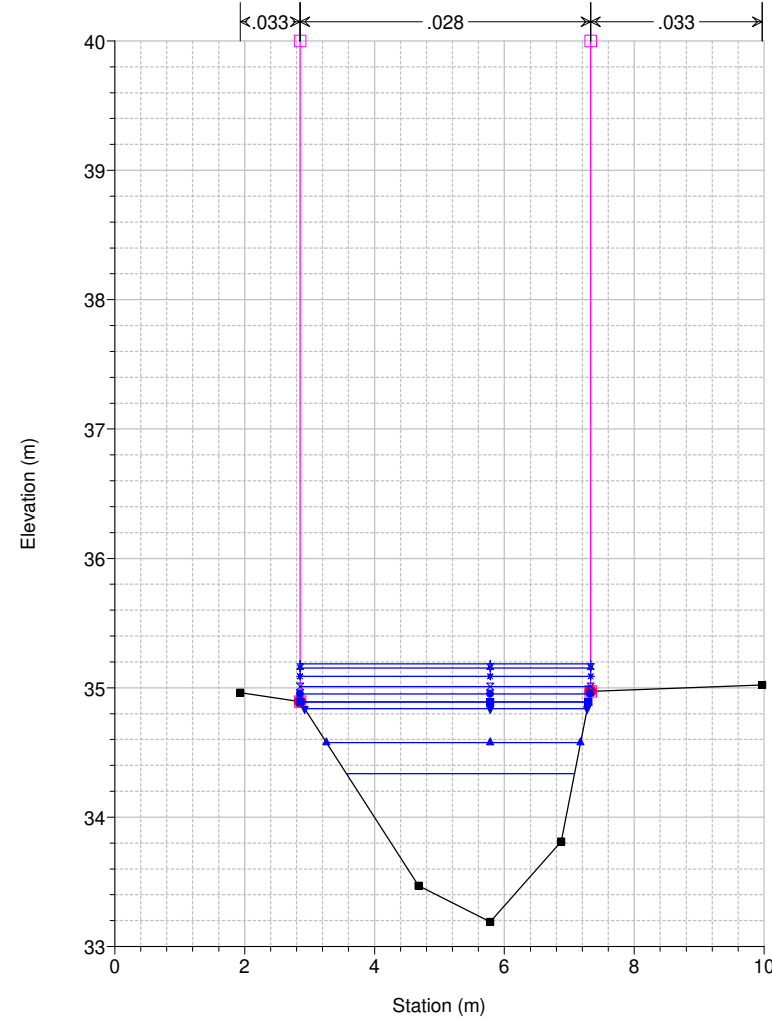

Studio Scandicci Torrenti Greve-Vingone
River = Fosso Stagnolo Reach = Stagnolo RS = 47 ST0037_D

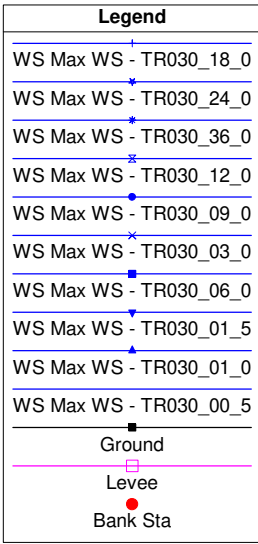
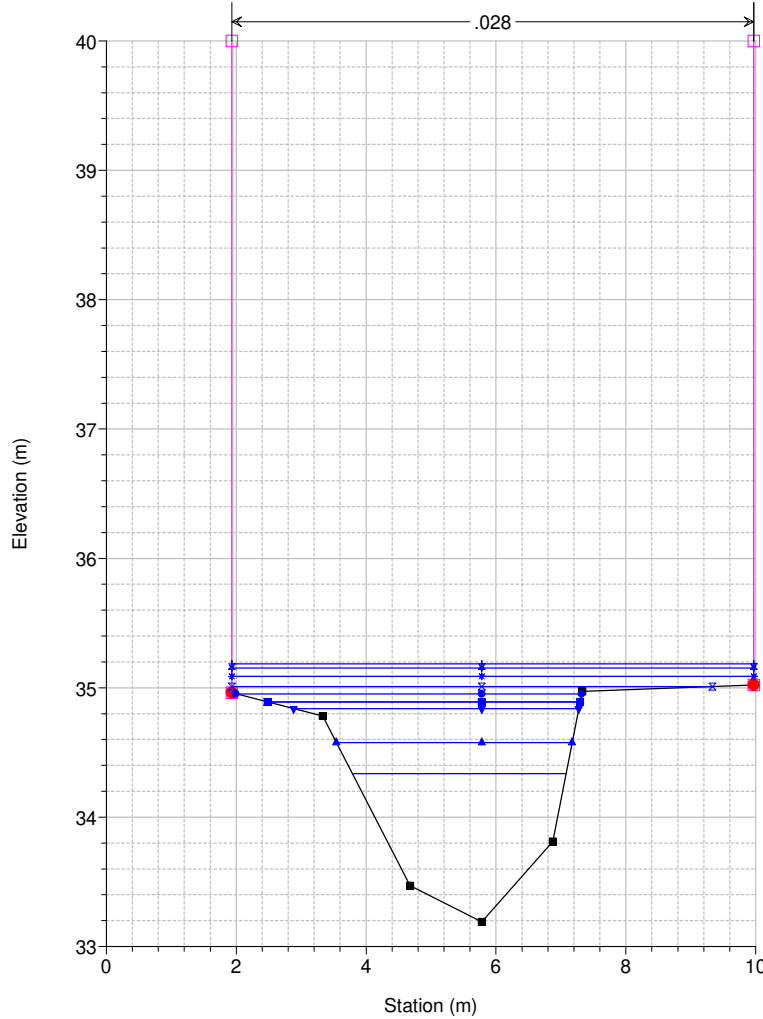

Studio Scandicci Torrenti Greve-Vingone
River = Fosso Stagnolo Reach = Stagnolo RS = 46 ST0038_

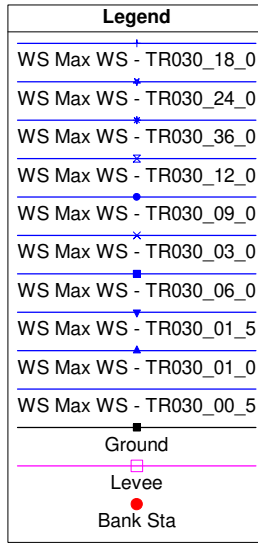
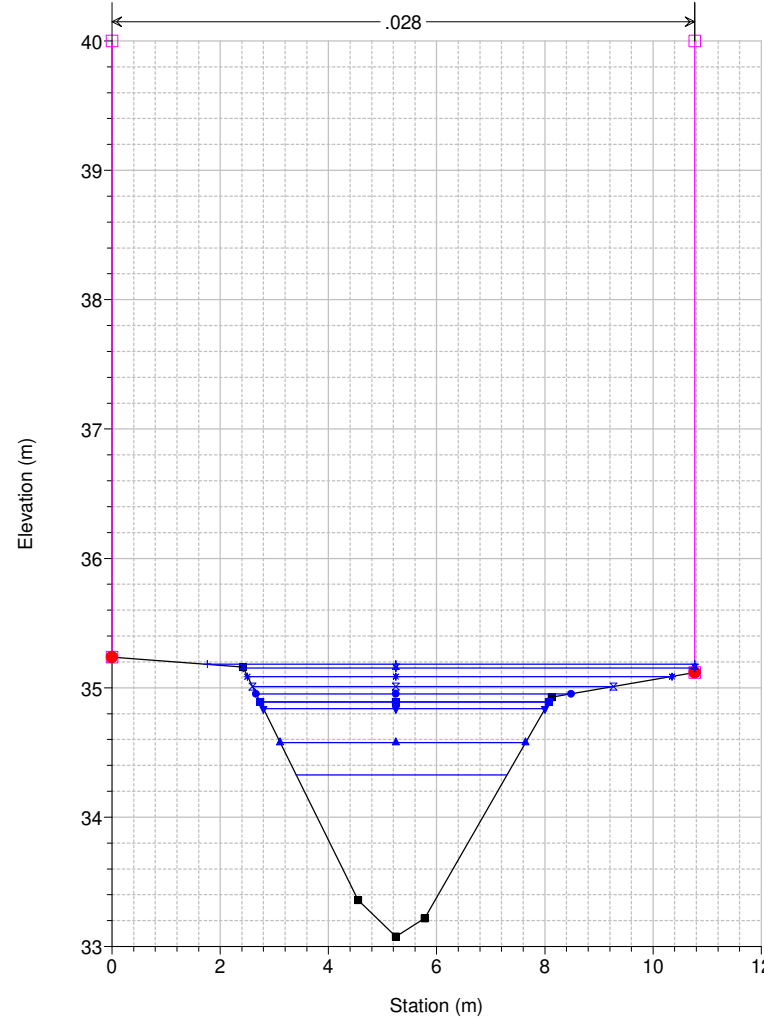

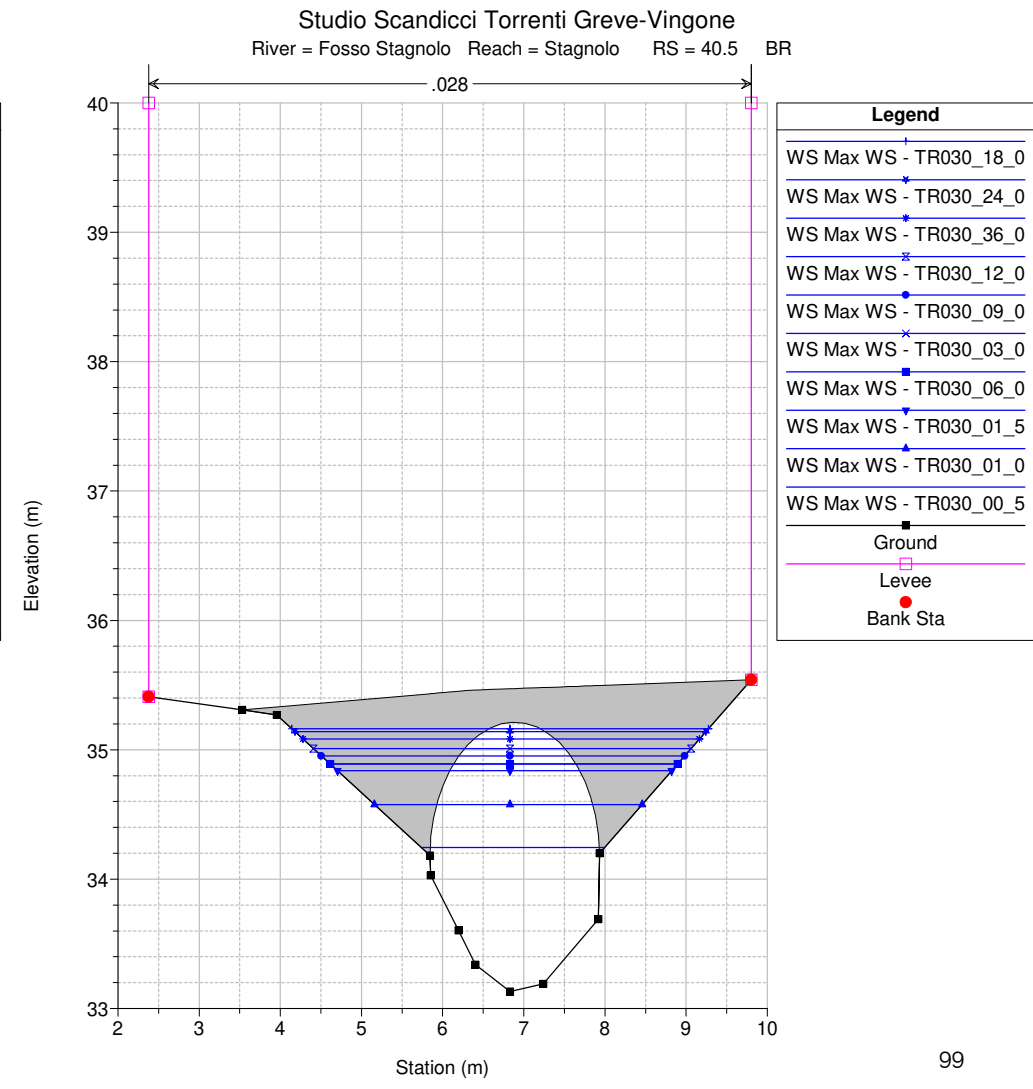
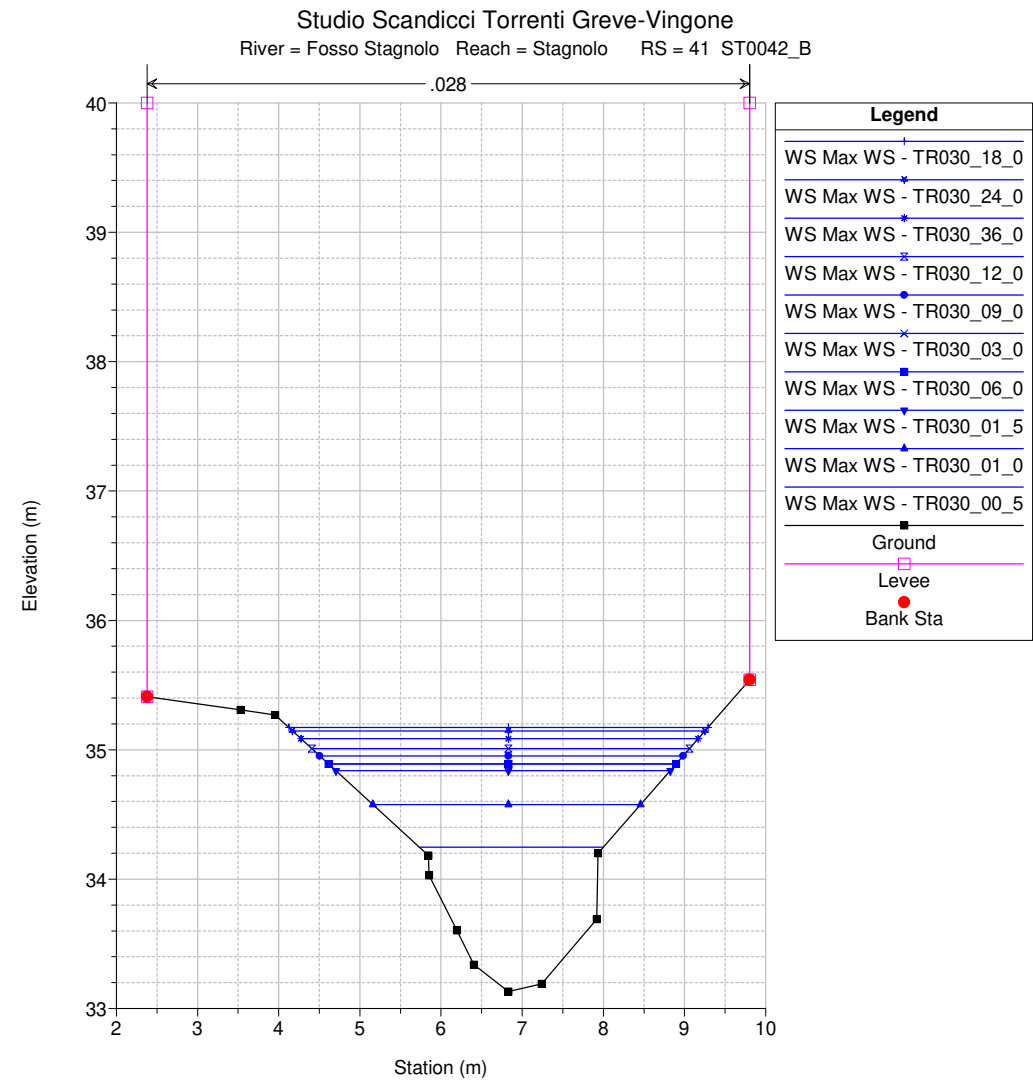
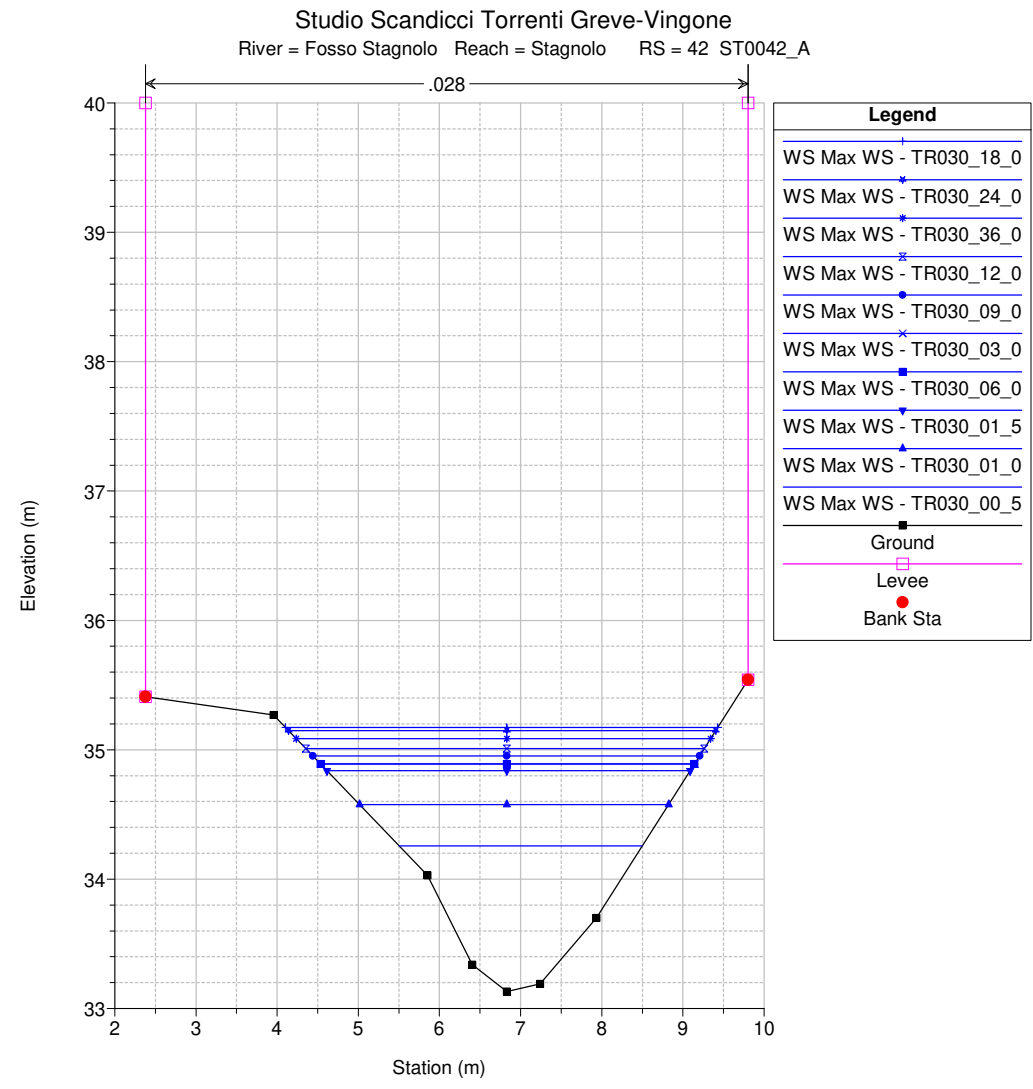
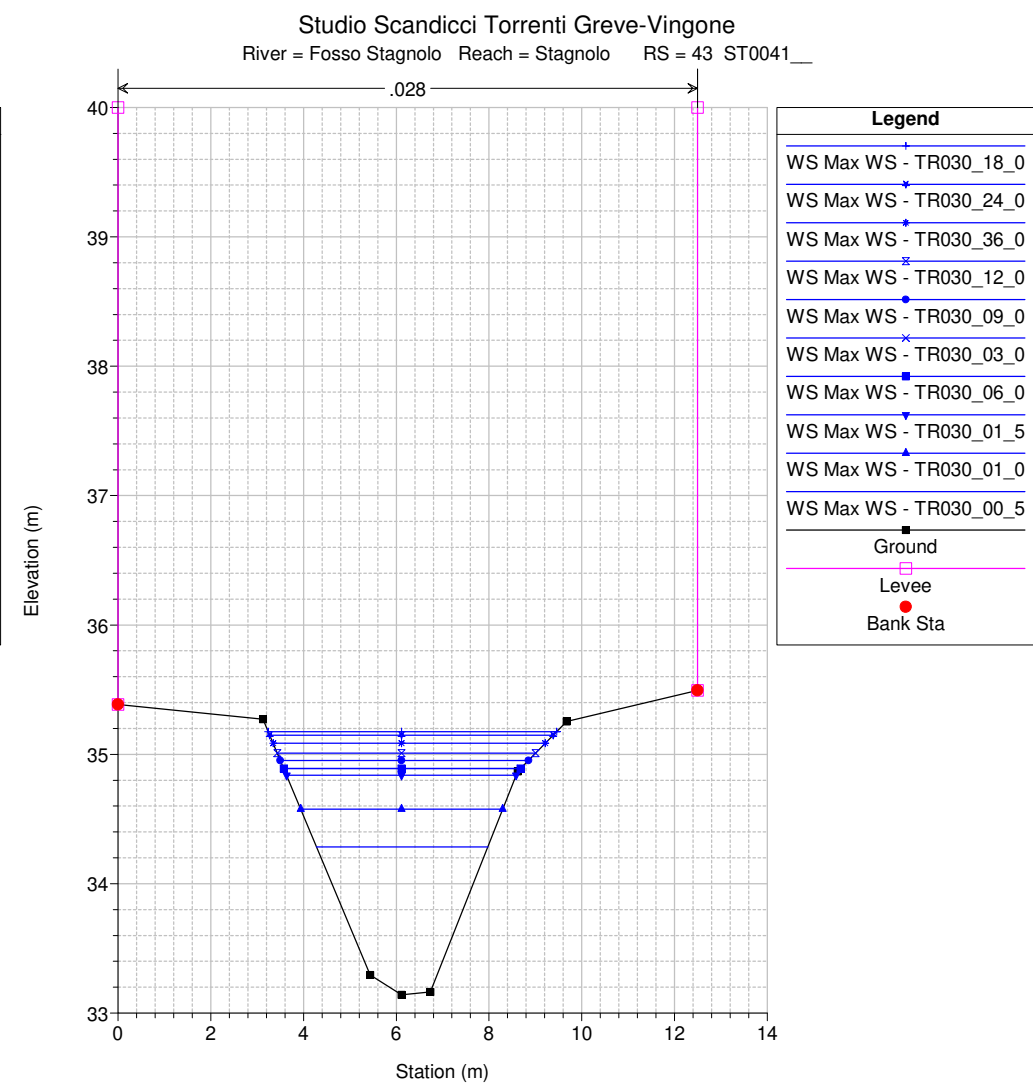
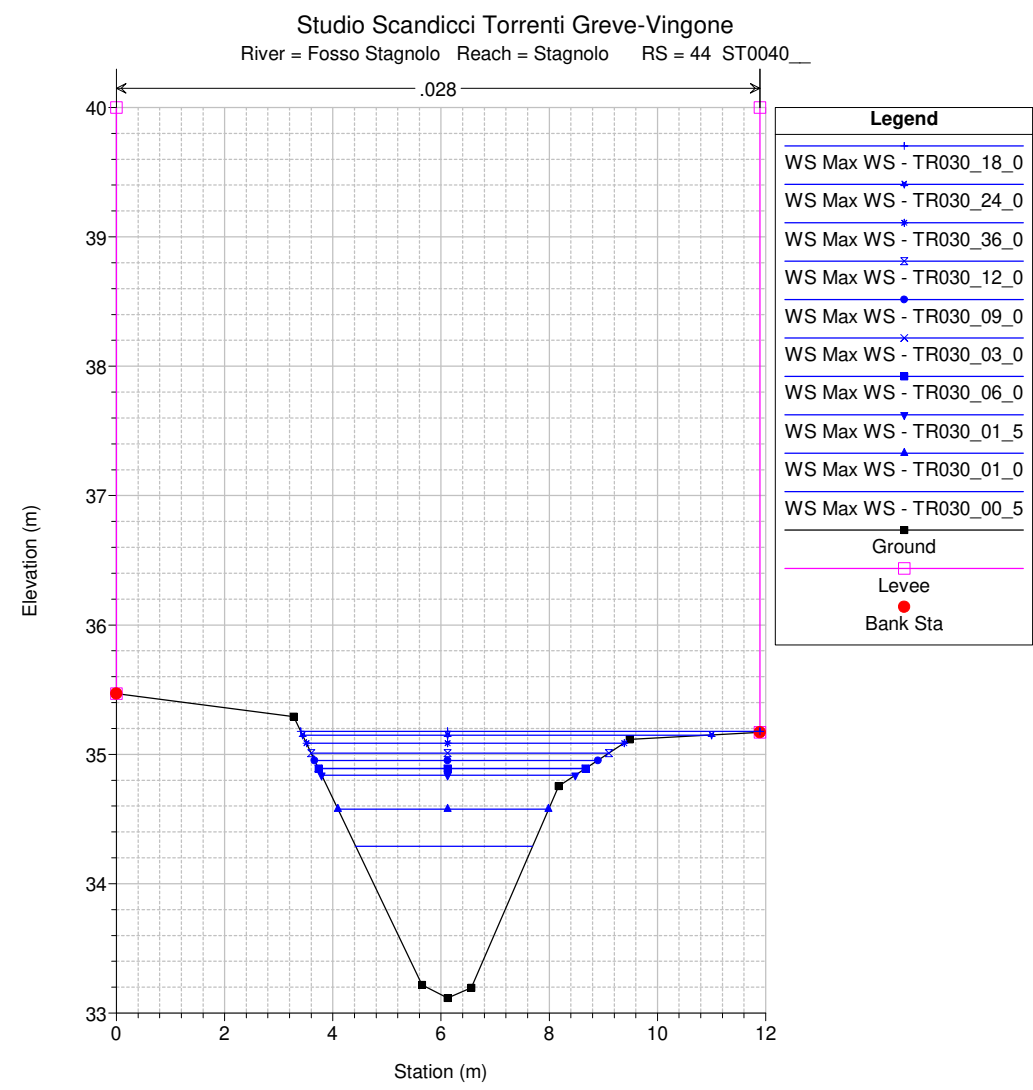
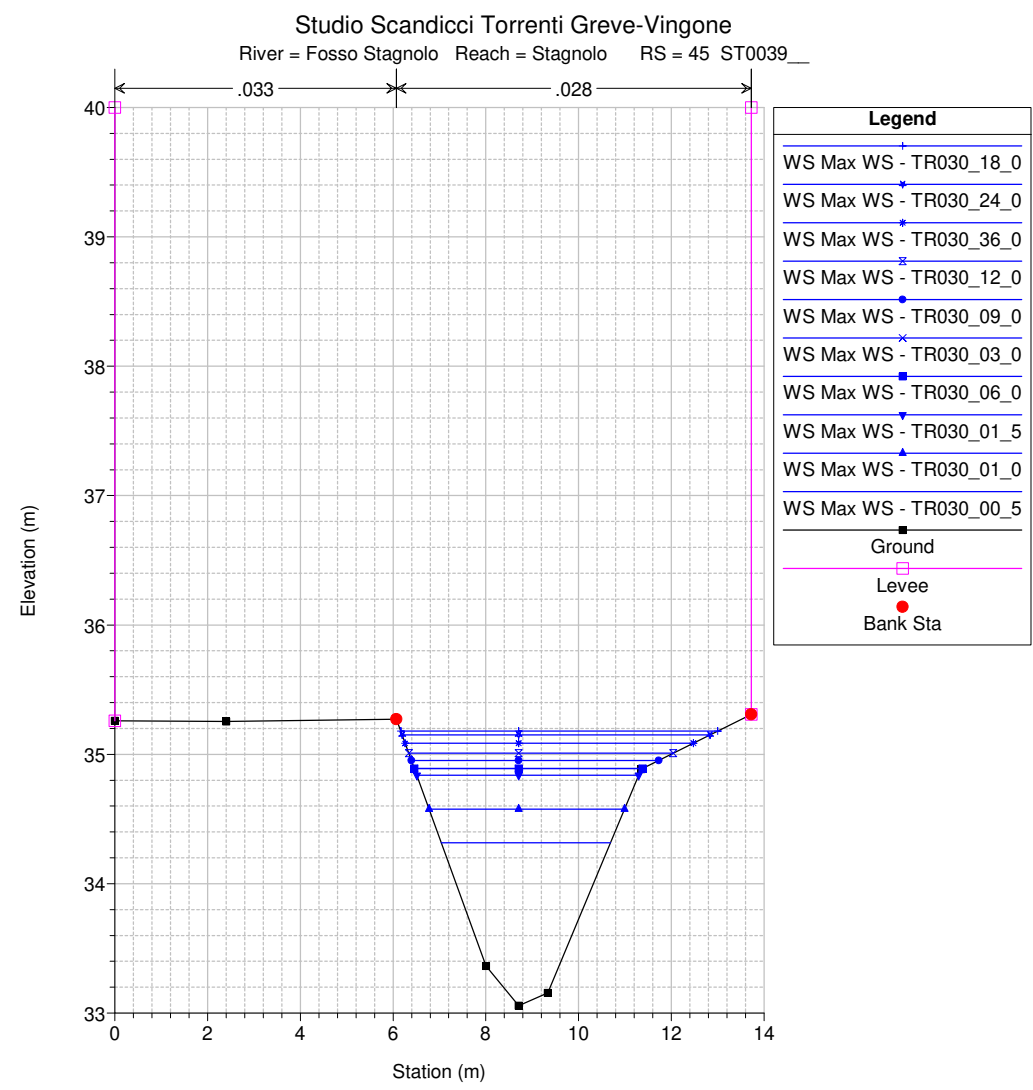

Studio Scandicci Torrenti Greve-Vingone
River = Fosso Stagnolo Reach = Stagnolo RS = 40.5 BR

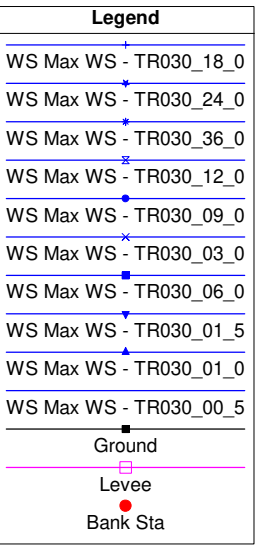
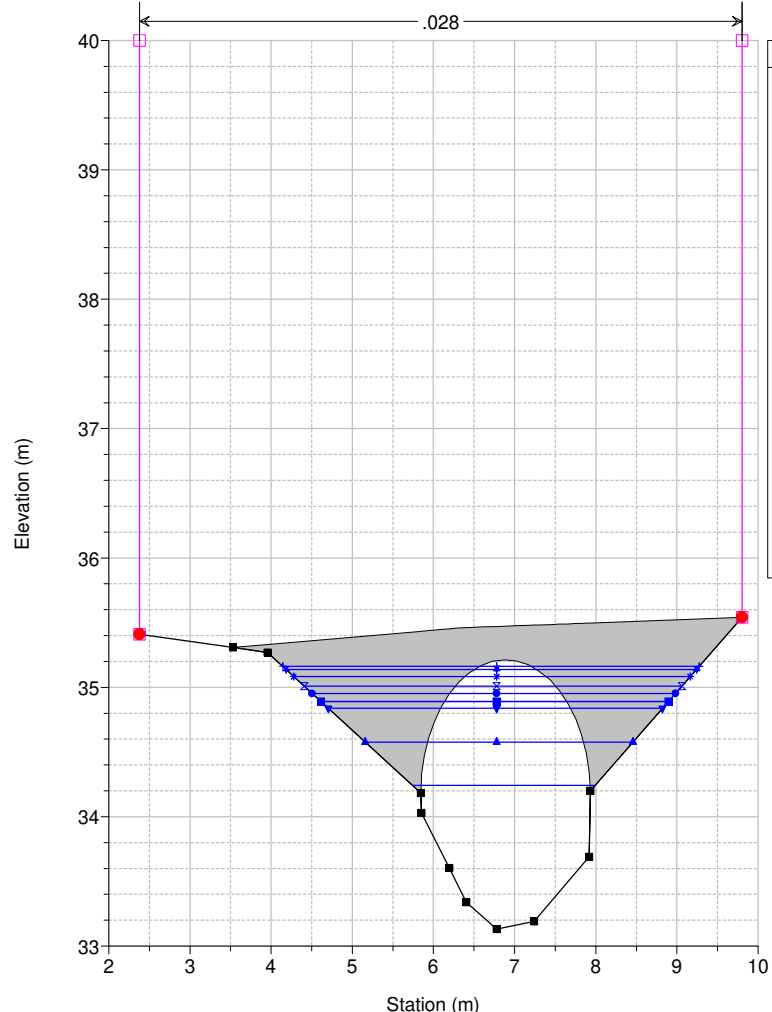

Studio Scandicci Torrenti Greve-Vingone
River = Fosso Stagnolo Reach = Stagnolo RS = 40 ST0042_C

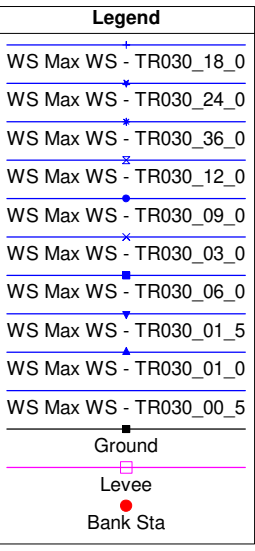
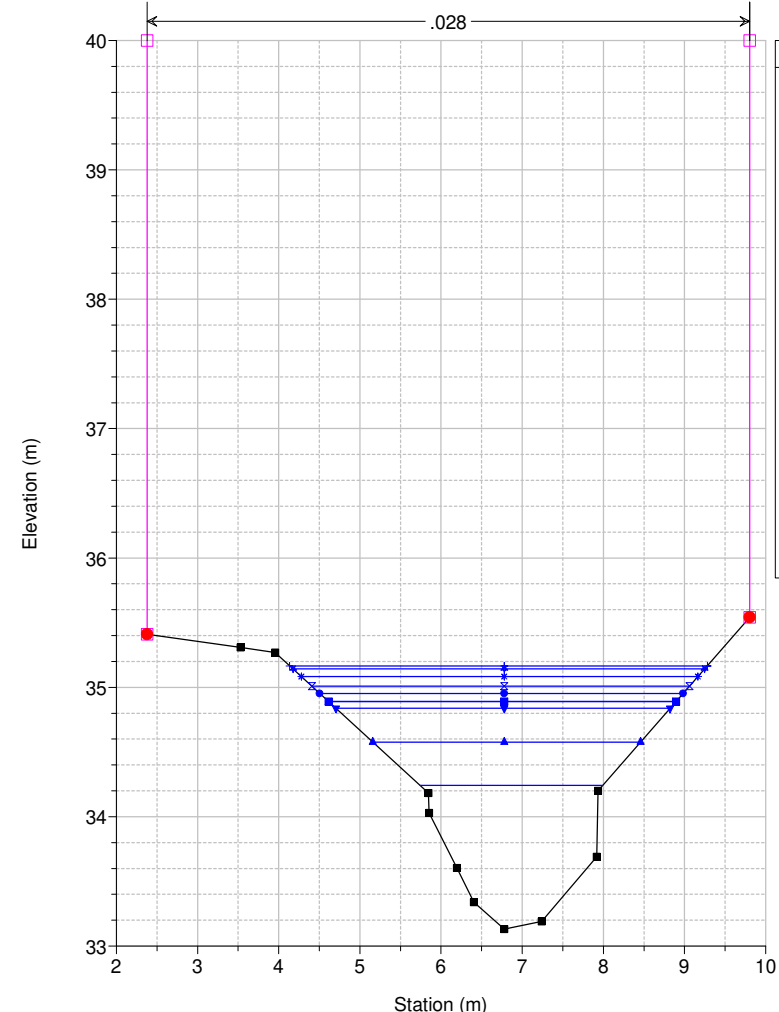

Studio Scandicci Torrenti Greve-Vingone
River = Fosso Stagnolo Reach = Stagnolo RS = 39 ST0042_D

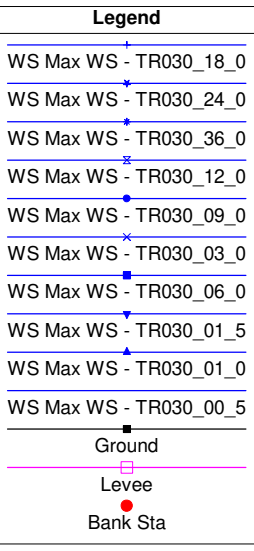
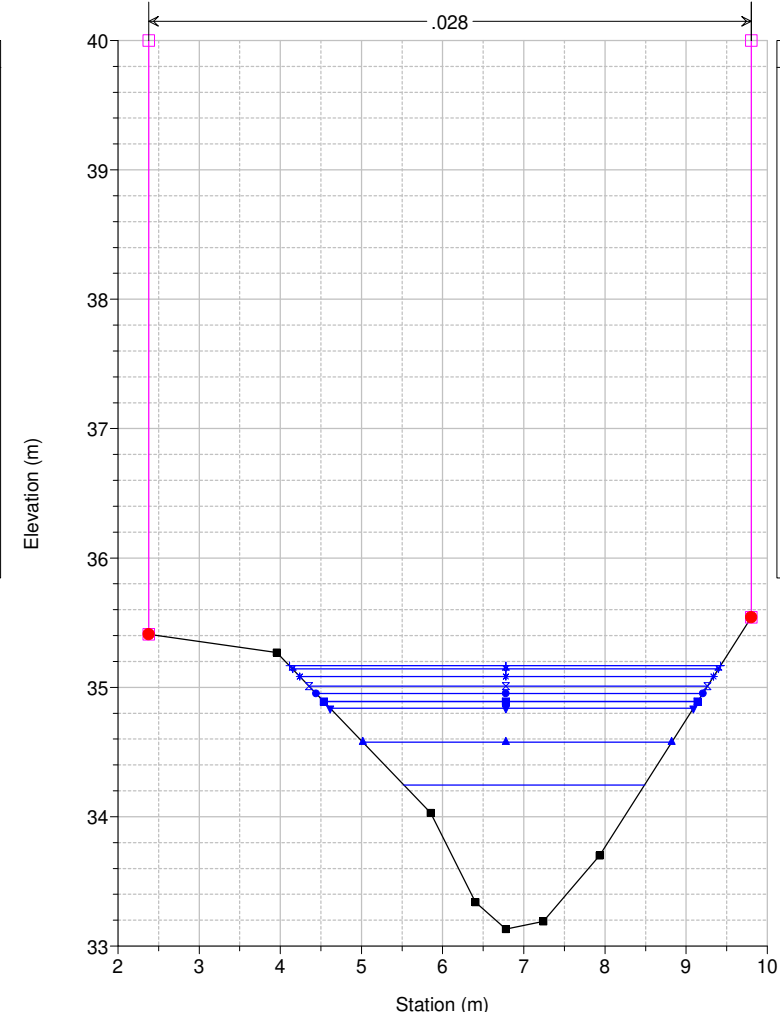

Studio Scandicci Torrenti Greve-Vingone
River = Fosso Stagnolo Reach = Stagnolo RS = 38 ST0043_

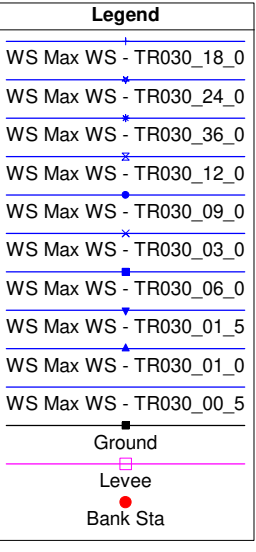
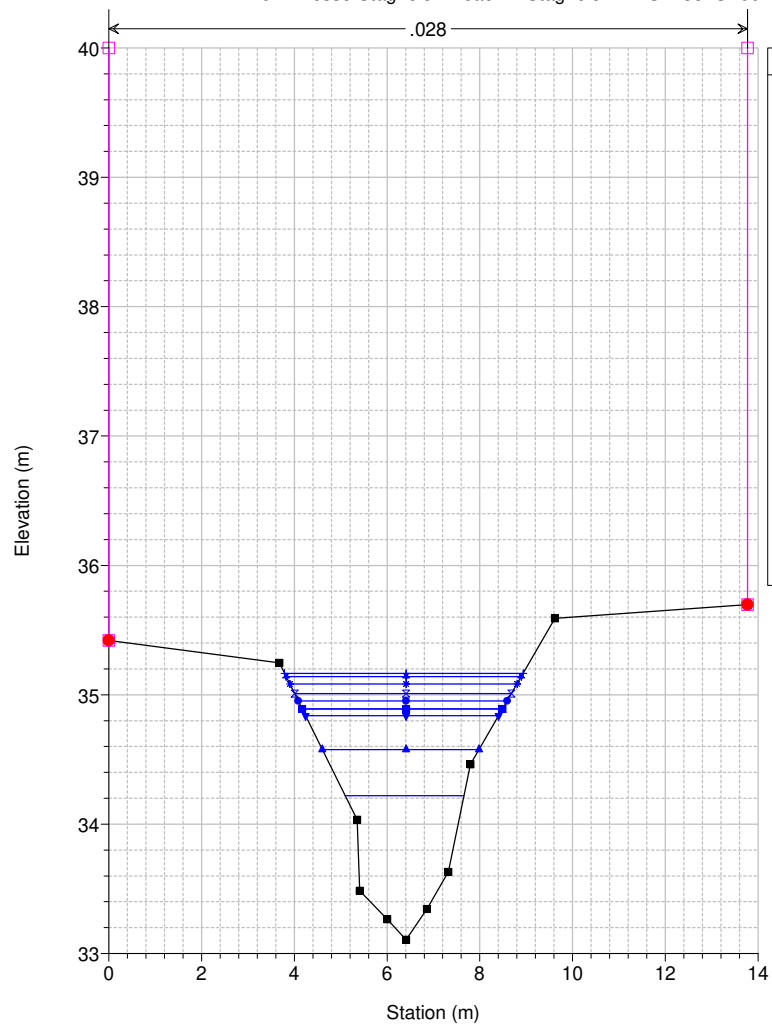

Studio Scandicci Torrenti Greve-Vingone
River = Fosso Stagnolo Reach = Stagnolo RS = 37 ST0044_A

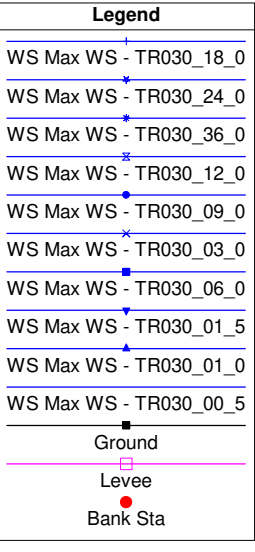
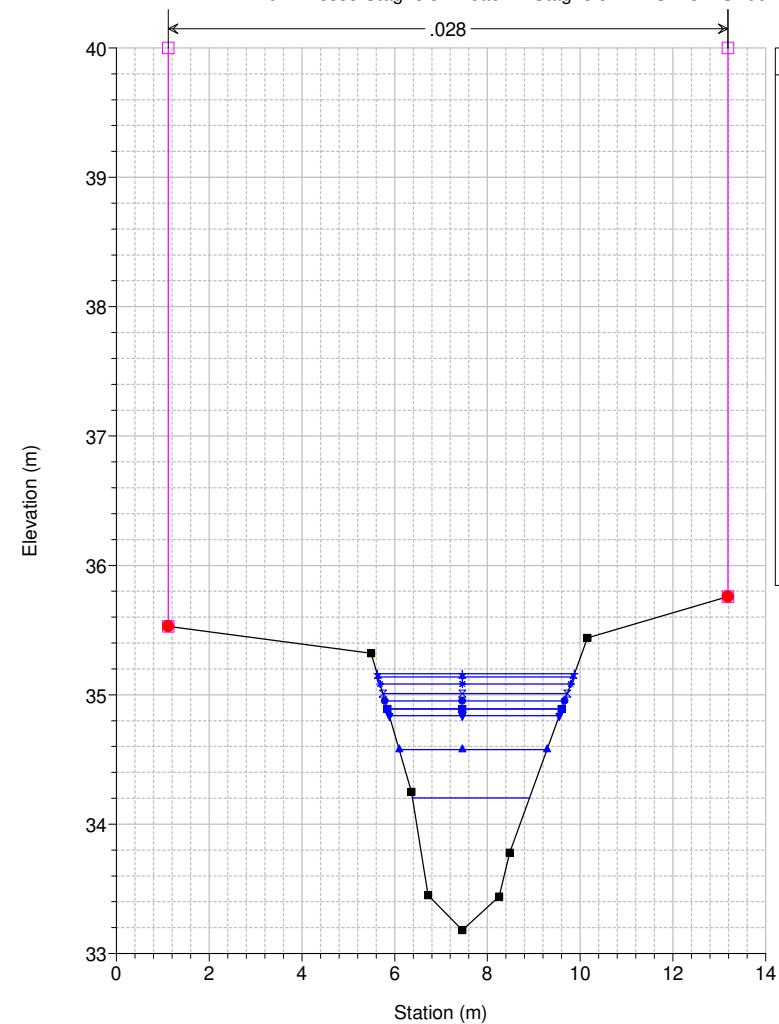

Studio Scandicci Torrenti Greve-Vingone
River = Fosso Stagnolo Reach = Stagnolo RS = 36 ST0044_B

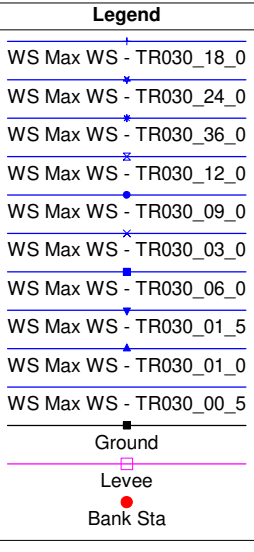
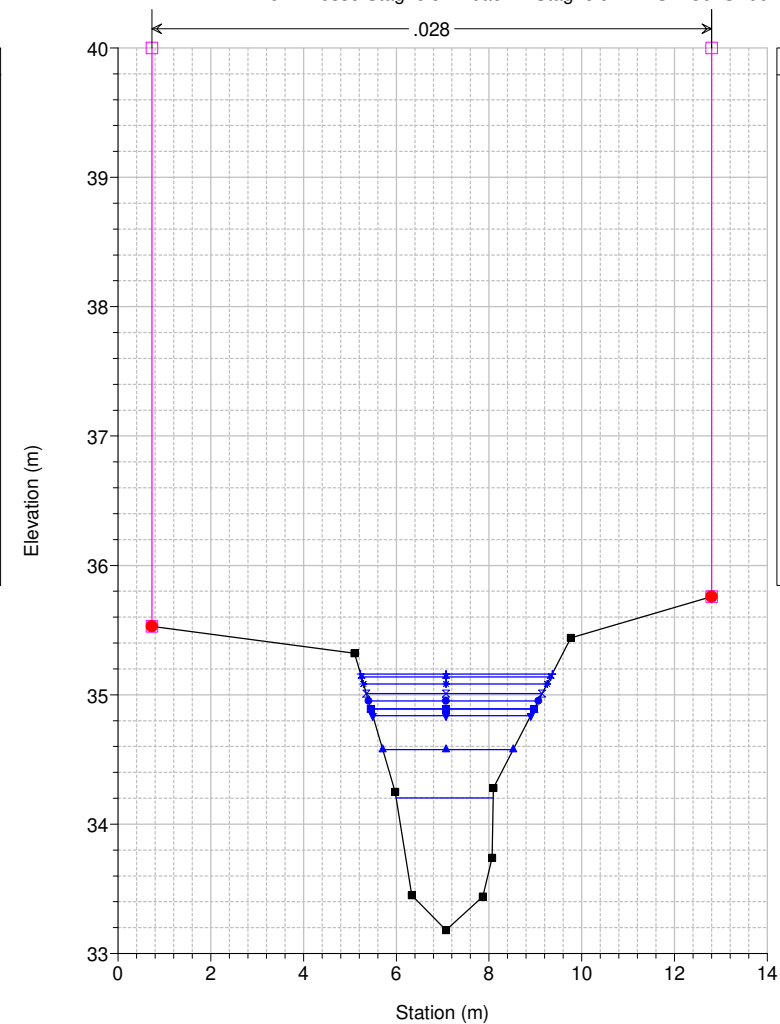

Studio Scandicci Torrenti Greve-Vingone
River = Fosso Stagnolo Reach = Stagnolo RS = 35.5 BR

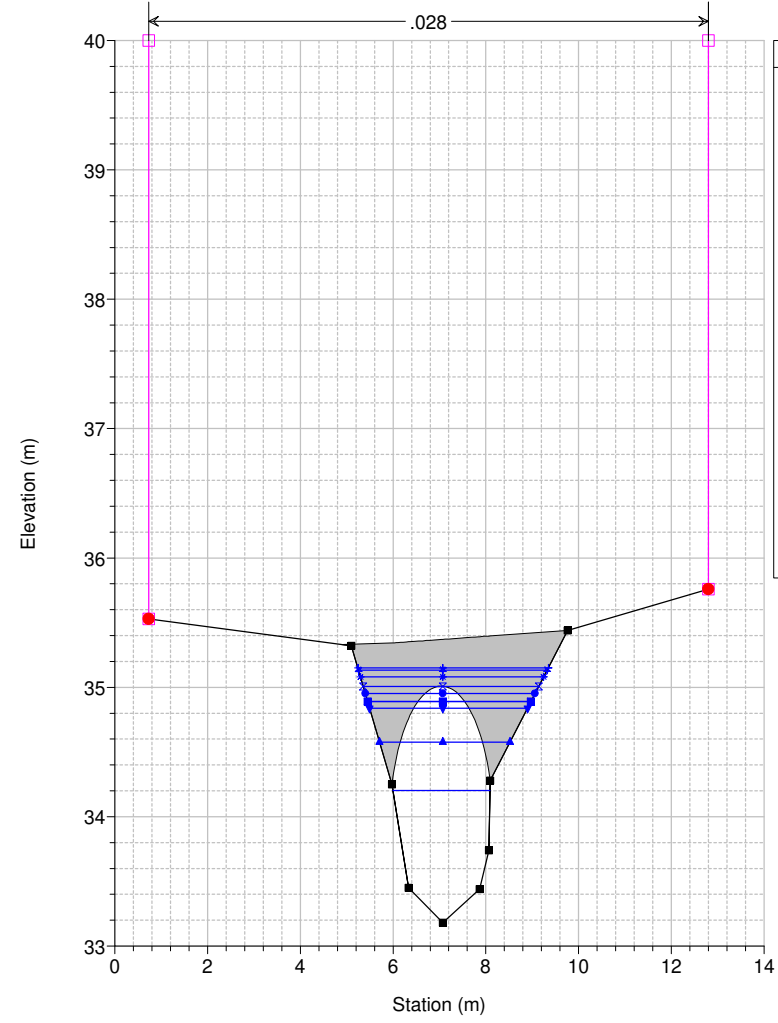

Legend	
WS Max WS - TR030_18_0	+
WS Max WS - TR030_24_0	*
WS Max WS - TR030_36_0	o
WS Max WS - TR030_12_0	x
WS Max WS - TR030_09_0	•
WS Max WS - TR030_03_0	x
WS Max WS - TR030_06_0	■
WS Max WS - TR030_01_5	▼
WS Max WS - TR030_01_0	▲
WS Max WS - TR030_00_5	■
Ground	—
Levee	—□—
Bank Sta	•

Studio Scandicci Torrenti Greve-Vingone
River = Fosso Stagnolo Reach = Stagnolo RS = 35.5 BR

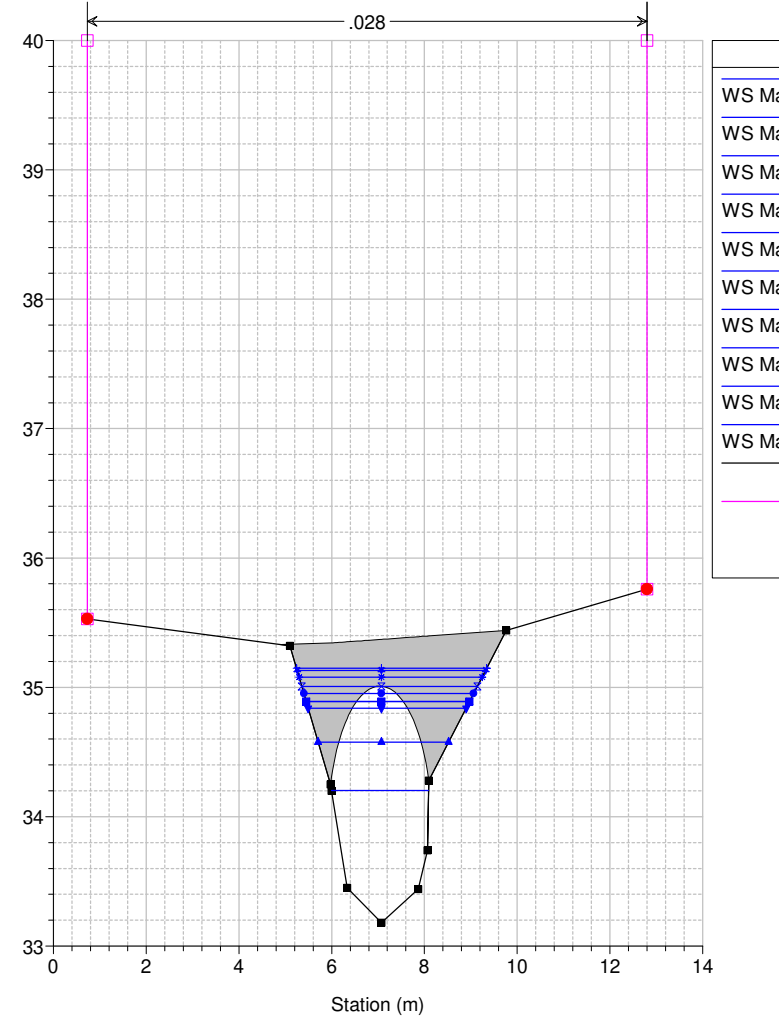

Legend	
WS Max WS - TR030_18_0	+
WS Max WS - TR030_24_0	*
WS Max WS - TR030_36_0	o
WS Max WS - TR030_12_0	x
WS Max WS - TR030_09_0	•
WS Max WS - TR030_03_0	x
WS Max WS - TR030_06_0	■
WS Max WS - TR030_01_5	▼
WS Max WS - TR030_01_0	▲
WS Max WS - TR030_00_5	■
Ground	—
Levee	—□—
Bank Sta	•

Studio Scandicci Torrenti Greve-Vingone
River = Fosso Stagnolo Reach = Stagnolo RS = 35 ST0044_C

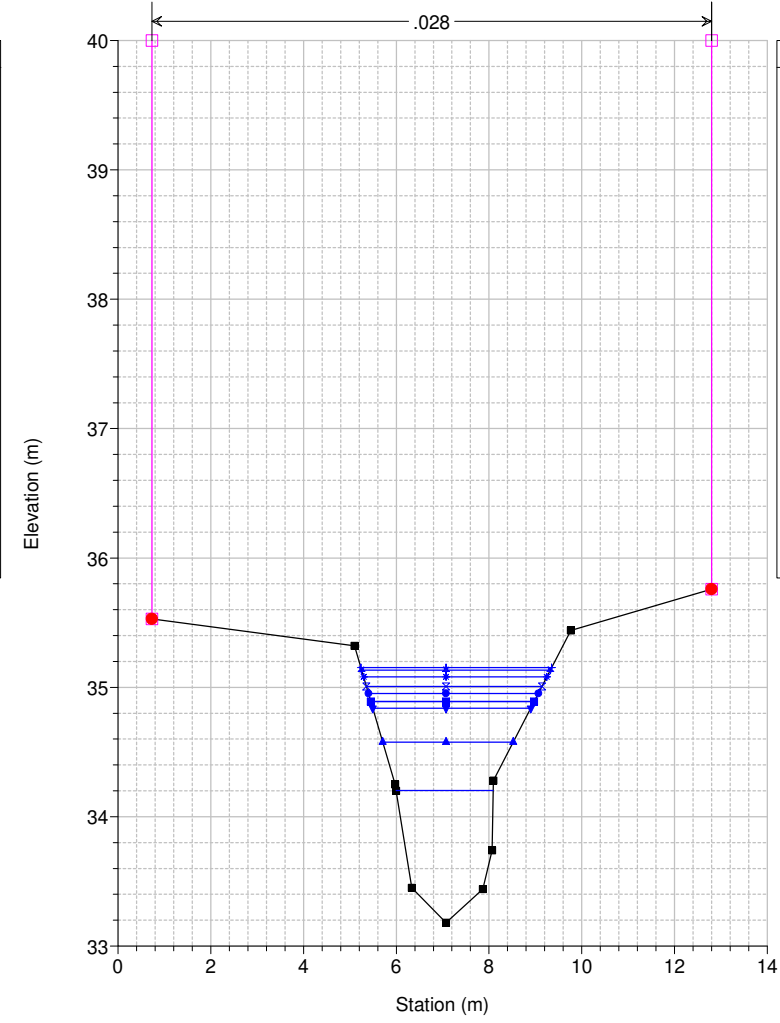

Legend	
WS Max WS - TR030_18_0	+
WS Max WS - TR030_24_0	*
WS Max WS - TR030_36_0	o
WS Max WS - TR030_12_0	x
WS Max WS - TR030_09_0	•
WS Max WS - TR030_03_0	x
WS Max WS - TR030_06_0	■
WS Max WS - TR030_01_5	▼
WS Max WS - TR030_01_0	▲
WS Max WS - TR030_00_5	■
Ground	—
Levee	—□—
Bank Sta	•

Studio Scandicci Torrenti Greve-Vingone
River = Fosso Stagnolo Reach = Stagnolo RS = 34 ST0044_D

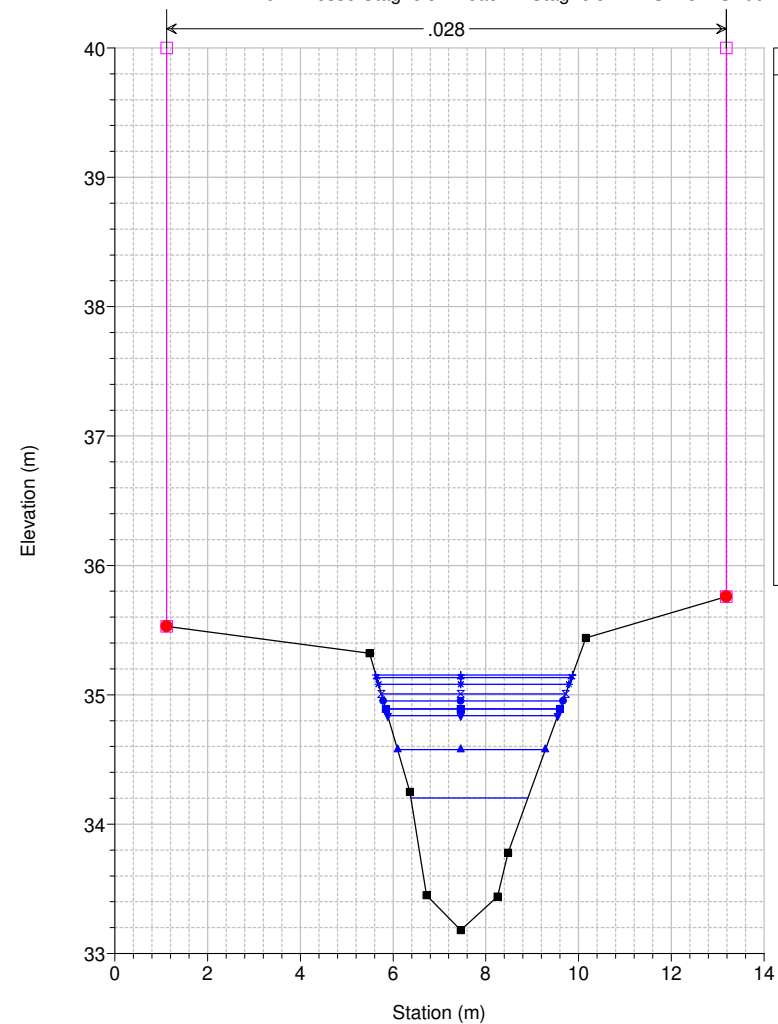

Legend	
WS Max WS - TR030_18_0	+
WS Max WS - TR030_24_0	*
WS Max WS - TR030_36_0	o
WS Max WS - TR030_12_0	x
WS Max WS - TR030_09_0	•
WS Max WS - TR030_03_0	x
WS Max WS - TR030_06_0	■
WS Max WS - TR030_01_5	▼
WS Max WS - TR030_01_0	▲
WS Max WS - TR030_00_5	■
Ground	—
Levee	—□—
Bank Sta	•

Studio Scandicci Torrenti Greve-Vingone
River = Fosso Stagnolo Reach = Stagnolo RS = 33 ST0045_

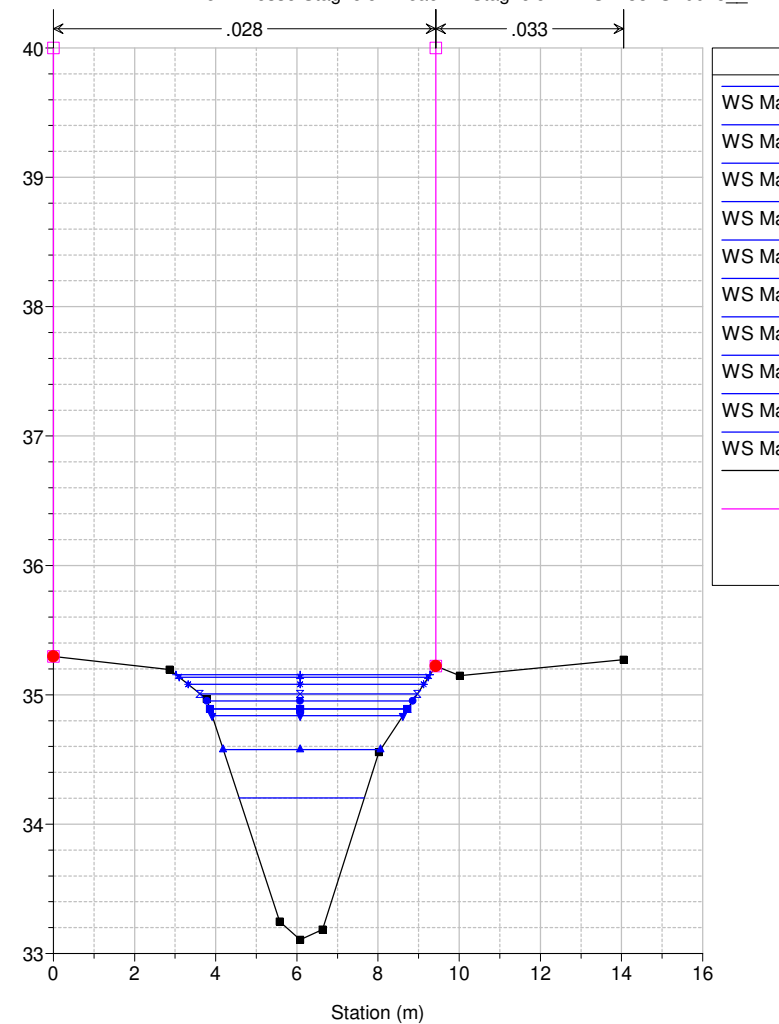

Legend	
WS Max WS - TR030_18_0	+
WS Max WS - TR030_24_0	*
WS Max WS - TR030_36_0	o
WS Max WS - TR030_12_0	x
WS Max WS - TR030_09_0	•
WS Max WS - TR030_03_0	x
WS Max WS - TR030_06_0	■
WS Max WS - TR030_01_5	▼
WS Max WS - TR030_01_0	▲
WS Max WS - TR030_00_5	■
Ground	—
Levee	—□—
Bank Sta	•

Studio Scandicci Torrenti Greve-Vingone
River = Fosso Stagnolo Reach = Stagnolo RS = 32 ST0046_A

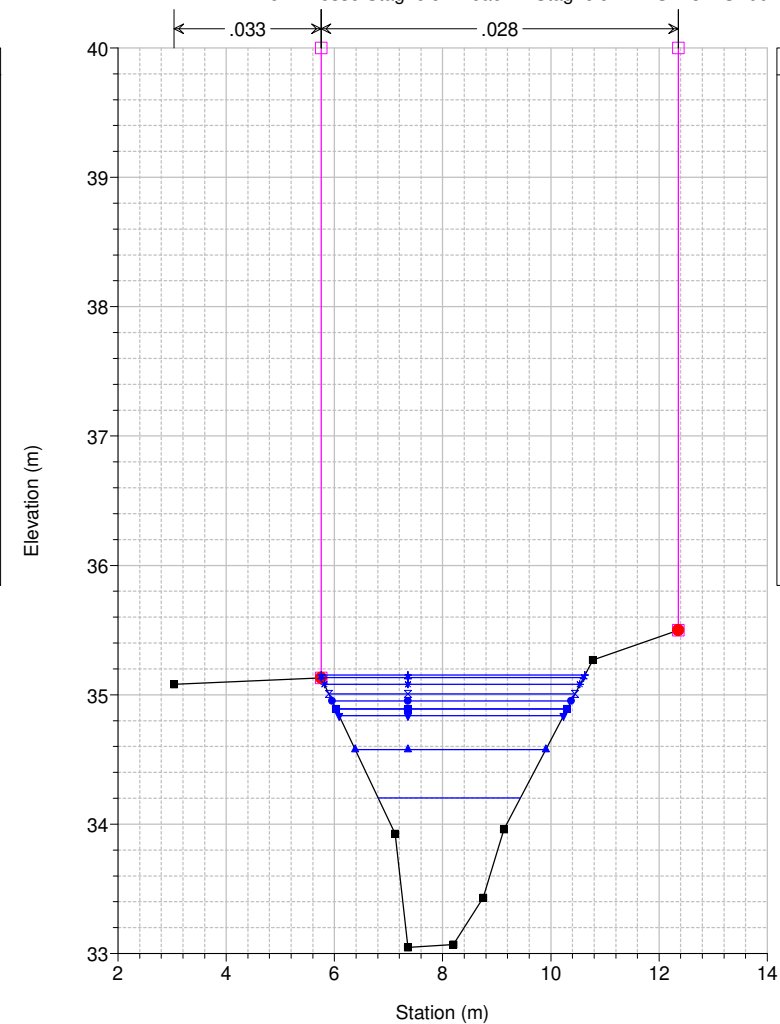

Legend	
WS Max WS - TR030_18_0	+
WS Max WS - TR030_24_0	*
WS Max WS - TR030_36_0	o
WS Max WS - TR030_12_0	x
WS Max WS - TR030_09_0	•
WS Max WS - TR030_03_0	x
WS Max WS - TR030_06_0	■
WS Max WS - TR030_01_5	▼
WS Max WS - TR030_01_0	▲
WS Max WS - TR030_00_5	■
Ground	—
Levee	—□—
Bank Sta	•

Studio Scandicci Torrenti Greve-Vingone
River = Fosso Stagnolo Reach = Stagnolo RS = 31 ST0046_B

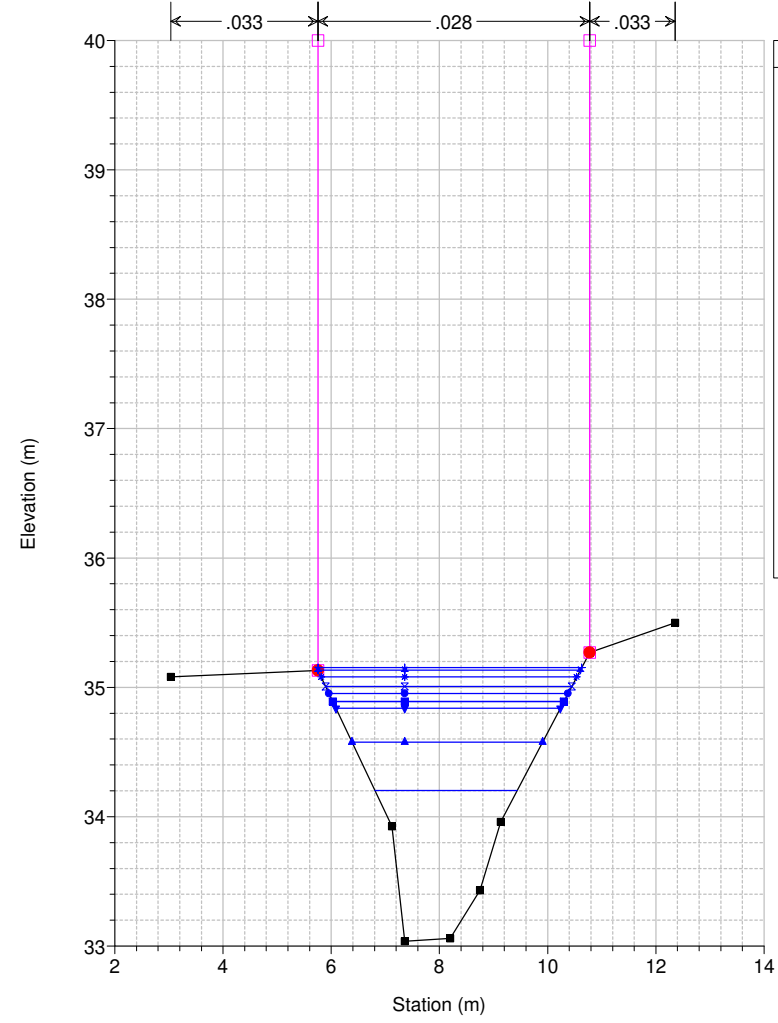

Legend

- WS Max WS - TR030_18_0
- WS Max WS - TR030_24_0
- WS Max WS - TR030_36_0
- WS Max WS - TR030_12_0
- WS Max WS - TR030_09_0
- WS Max WS - TR030_03_0
- WS Max WS - TR030_06_0
- WS Max WS - TR030_01_5
- WS Max WS - TR030_01_0
- WS Max WS - TR030_00_5
- Ground
- Levee
- Bank Sta

Studio Scandicci Torrenti Greve-Vingone
River = Fosso Stagnolo Reach = Stagnolo RS = 30.5 BR

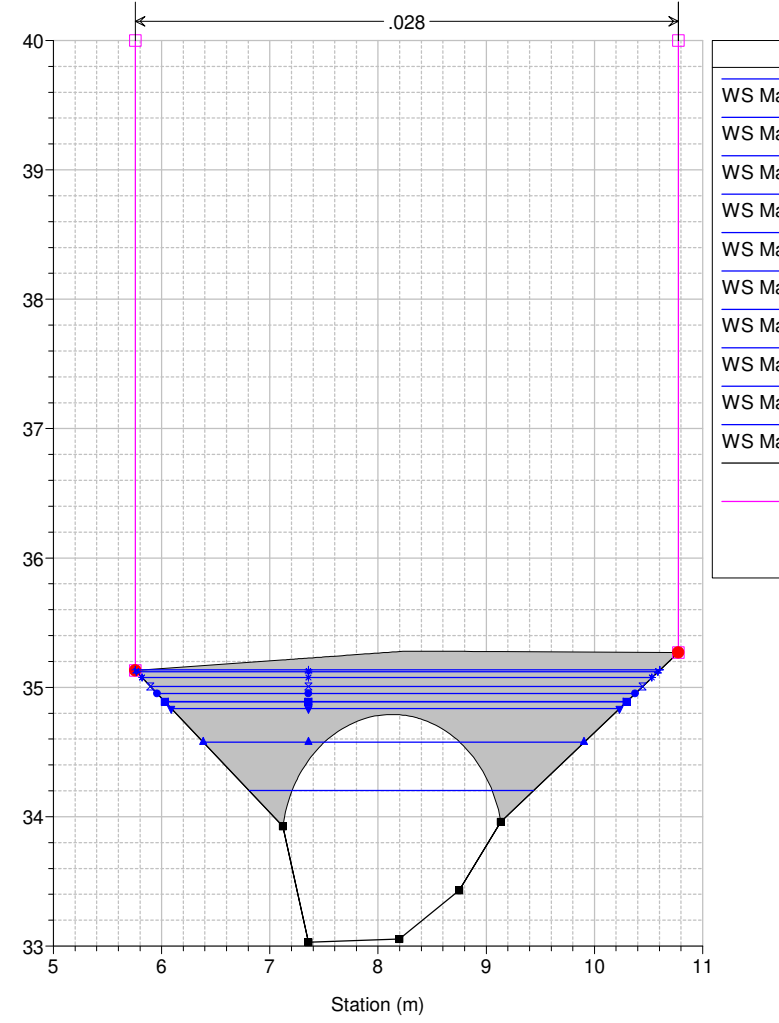

Legend

- WS Max WS - TR030_18_0
- WS Max WS - TR030_24_0
- WS Max WS - TR030_36_0
- WS Max WS - TR030_12_0
- WS Max WS - TR030_09_0
- WS Max WS - TR030_03_0
- WS Max WS - TR030_06_0
- WS Max WS - TR030_01_5
- WS Max WS - TR030_01_0
- WS Max WS - TR030_00_5
- Ground
- Levee
- Bank Sta

Studio Scandicci Torrenti Greve-Vingone
River = Fosso Stagnolo Reach = Stagnolo RS = 30.5 BR

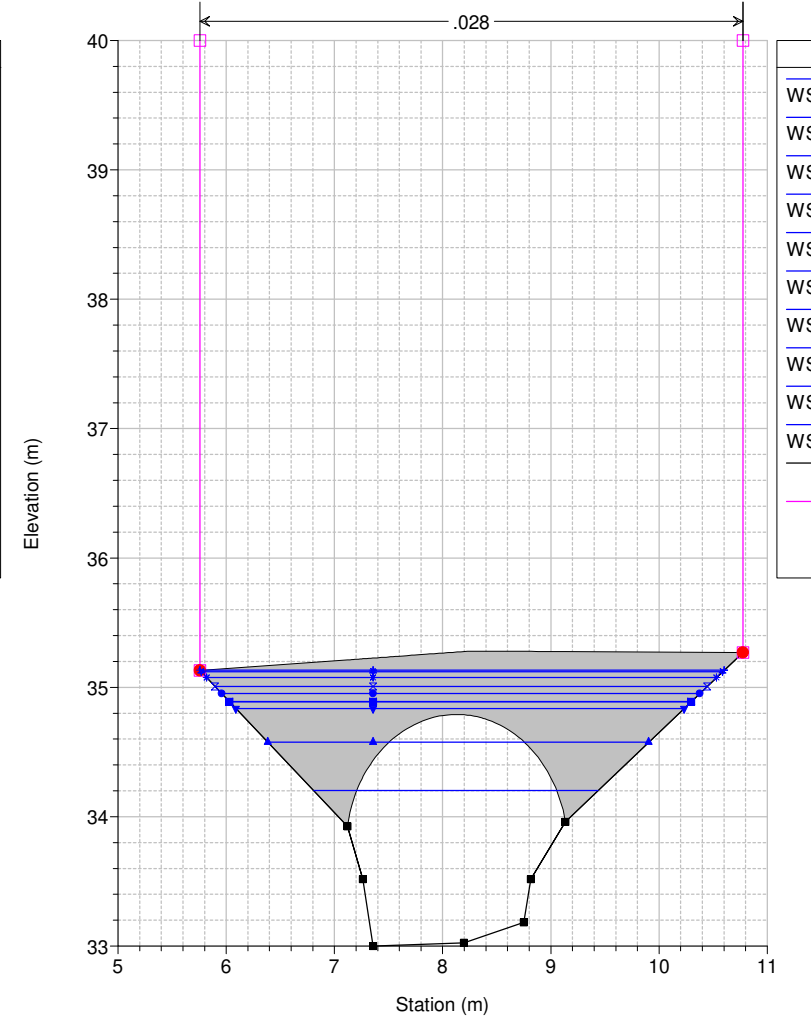

Legend

- WS Max WS - TR030_18_0
- WS Max WS - TR030_24_0
- WS Max WS - TR030_36_0
- WS Max WS - TR030_12_0
- WS Max WS - TR030_09_0
- WS Max WS - TR030_03_0
- WS Max WS - TR030_06_0
- WS Max WS - TR030_01_5
- WS Max WS - TR030_01_0
- WS Max WS - TR030_00_5
- Ground
- Levee
- Bank Sta

Studio Scandicci Torrenti Greve-Vingone
River = Fosso Stagnolo Reach = Stagnolo RS = 30 ST0046_C

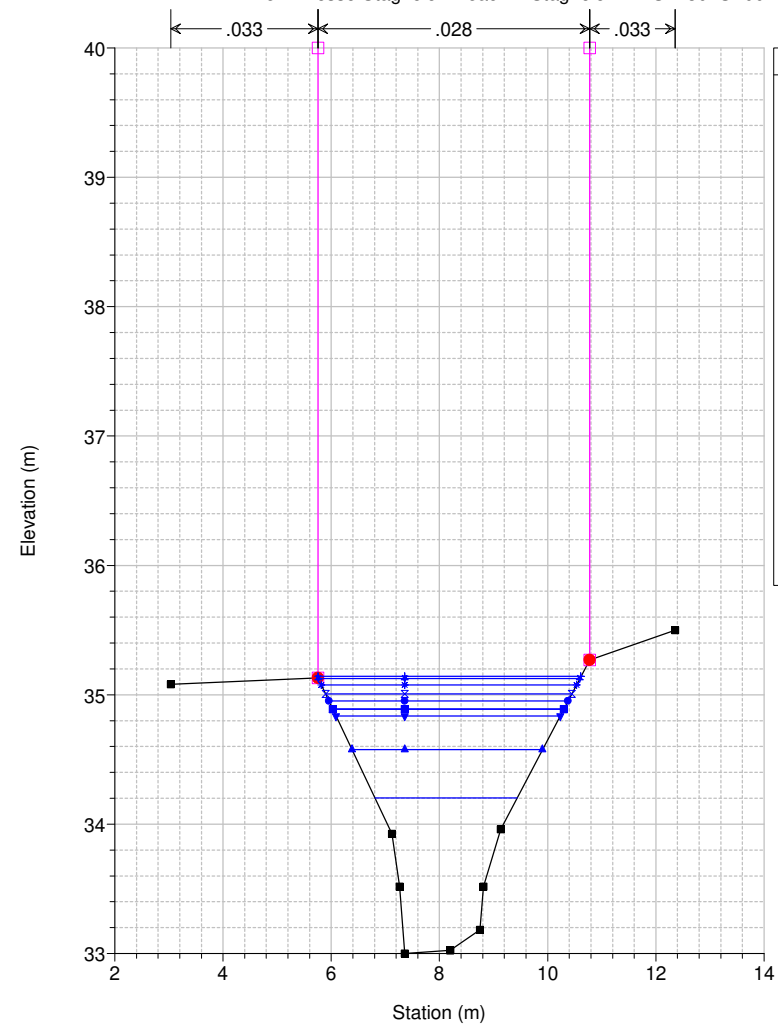

Legend

- WS Max WS - TR030_18_0
- WS Max WS - TR030_24_0
- WS Max WS - TR030_36_0
- WS Max WS - TR030_12_0
- WS Max WS - TR030_09_0
- WS Max WS - TR030_03_0
- WS Max WS - TR030_06_0
- WS Max WS - TR030_01_5
- WS Max WS - TR030_01_0
- WS Max WS - TR030_00_5
- Ground
- Levee
- Bank Sta

Studio Scandicci Torrenti Greve-Vingone
River = Fosso Stagnolo Reach = Stagnolo RS = 29 ST0046_D

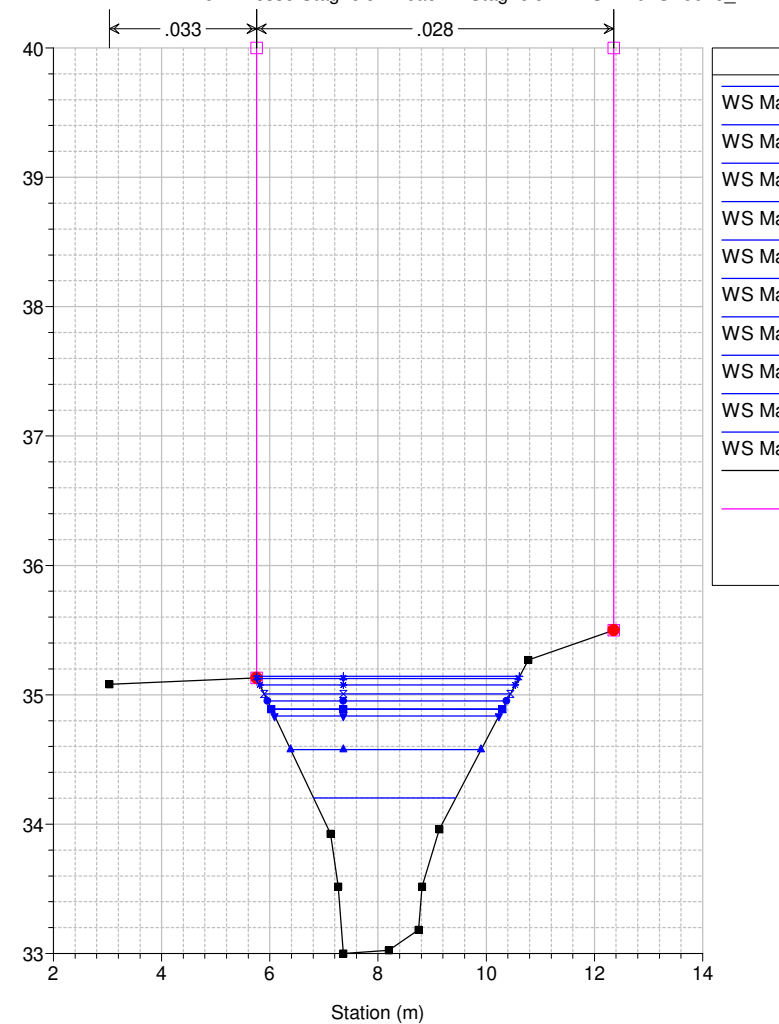

Legend

- WS Max WS - TR030_18_0
- WS Max WS - TR030_24_0
- WS Max WS - TR030_36_0
- WS Max WS - TR030_12_0
- WS Max WS - TR030_09_0
- WS Max WS - TR030_03_0
- WS Max WS - TR030_06_0
- WS Max WS - TR030_01_5
- WS Max WS - TR030_01_0
- WS Max WS - TR030_00_5
- Ground
- Levee
- Bank Sta

Studio Scandicci Torrenti Greve-Vingone
River = Fosso Stagnolo Reach = Stagnolo RS = 28 ST0047_

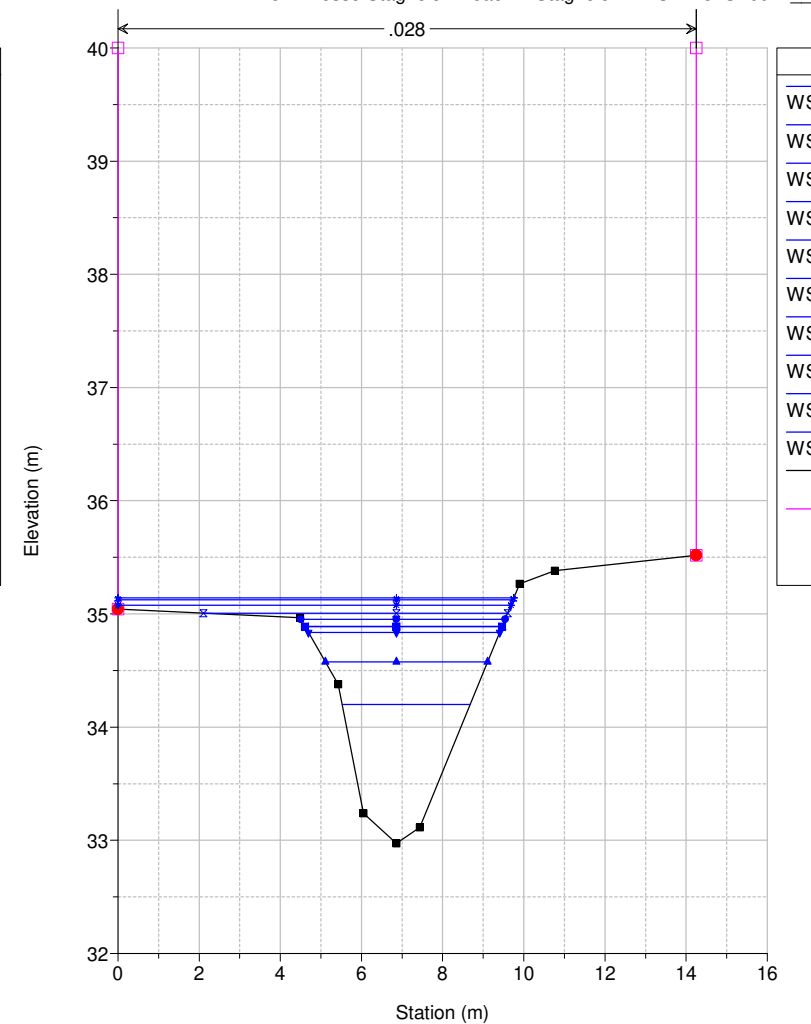

Legend

- WS Max WS - TR030_18_0
- WS Max WS - TR030_24_0
- WS Max WS - TR030_36_0
- WS Max WS - TR030_12_0
- WS Max WS - TR030_09_0
- WS Max WS - TR030_03_0
- WS Max WS - TR030_06_0
- WS Max WS - TR030_01_5
- WS Max WS - TR030_01_0
- WS Max WS - TR030_00_5
- Ground
- Levee
- Bank Sta

Studio Scandicci Torrenti Greve-Vingone
River = Fosso Stagnolo Reach = Stagnolo RS = 27 ST0048__

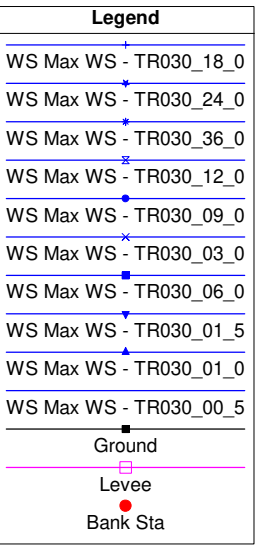
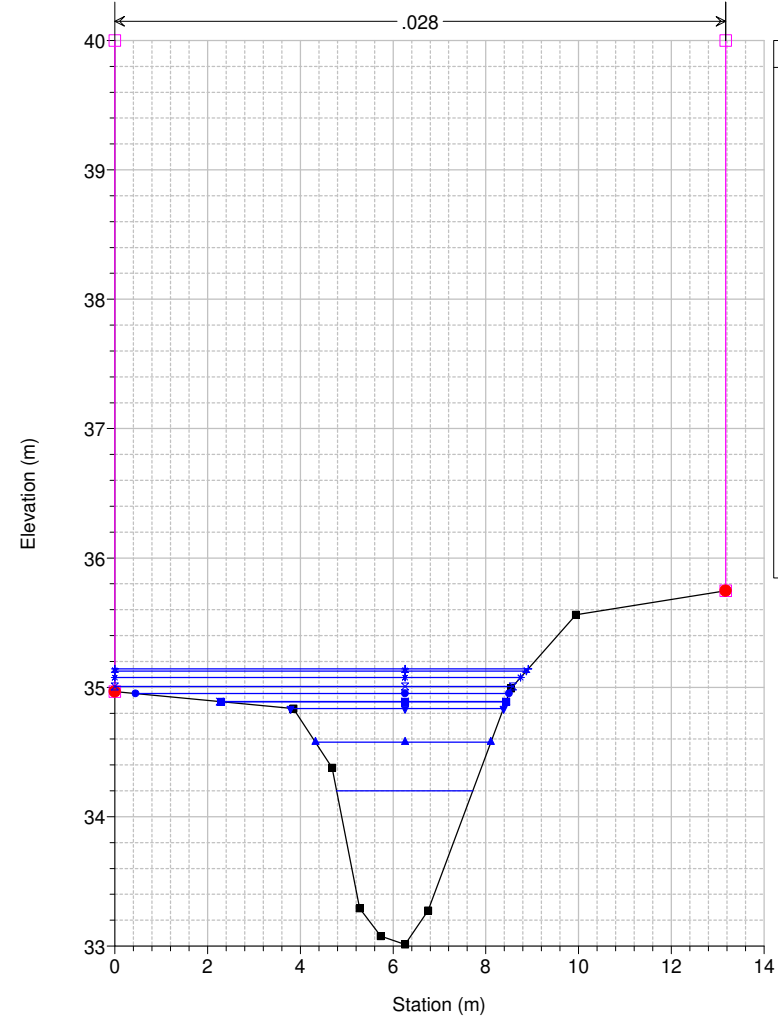

Studio Scandicci Torrenti Greve-Vingone
River = Fosso Stagnolo Reach = Stagnolo RS = 26 ST0049__

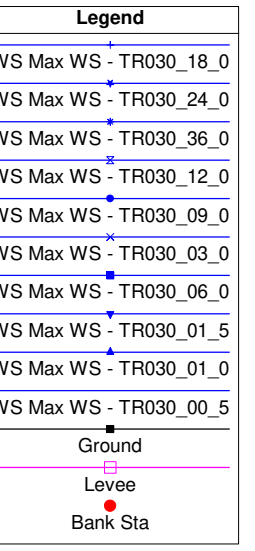
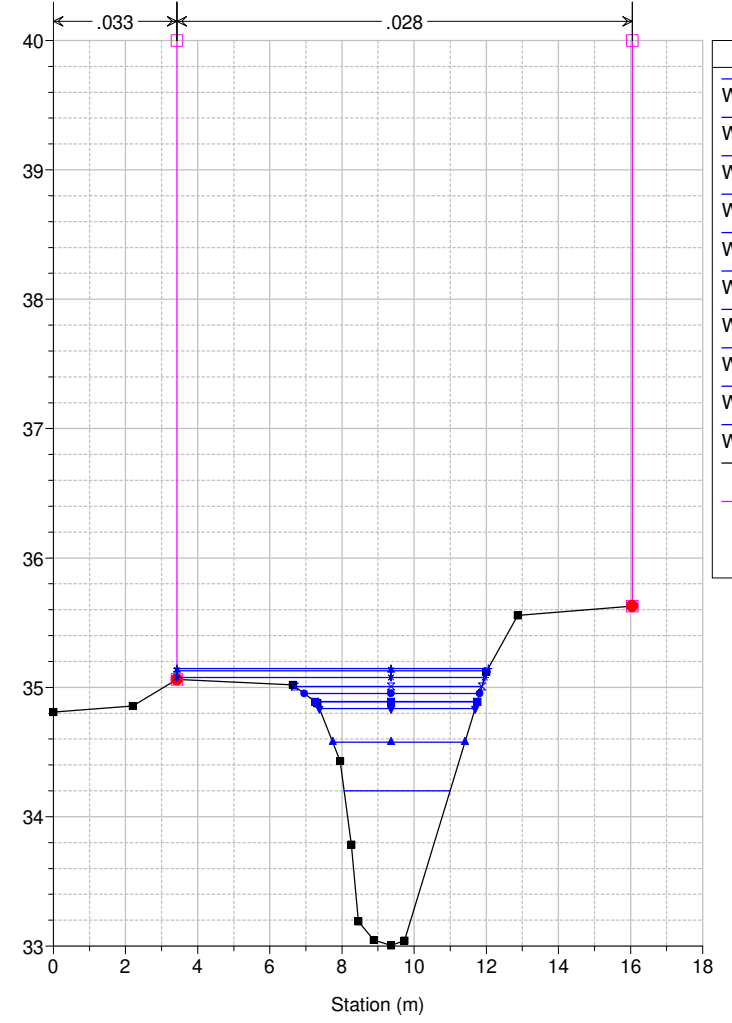

Studio Scandicci Torrenti Greve-Vingone
River = Fosso Stagnolo Reach = Stagnolo RS = 25 ST0050_A

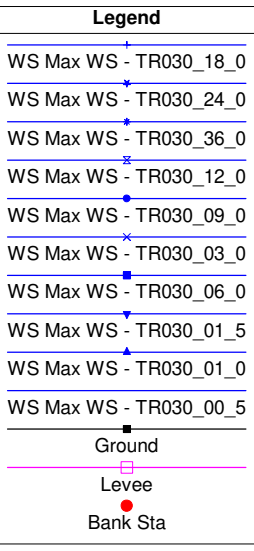
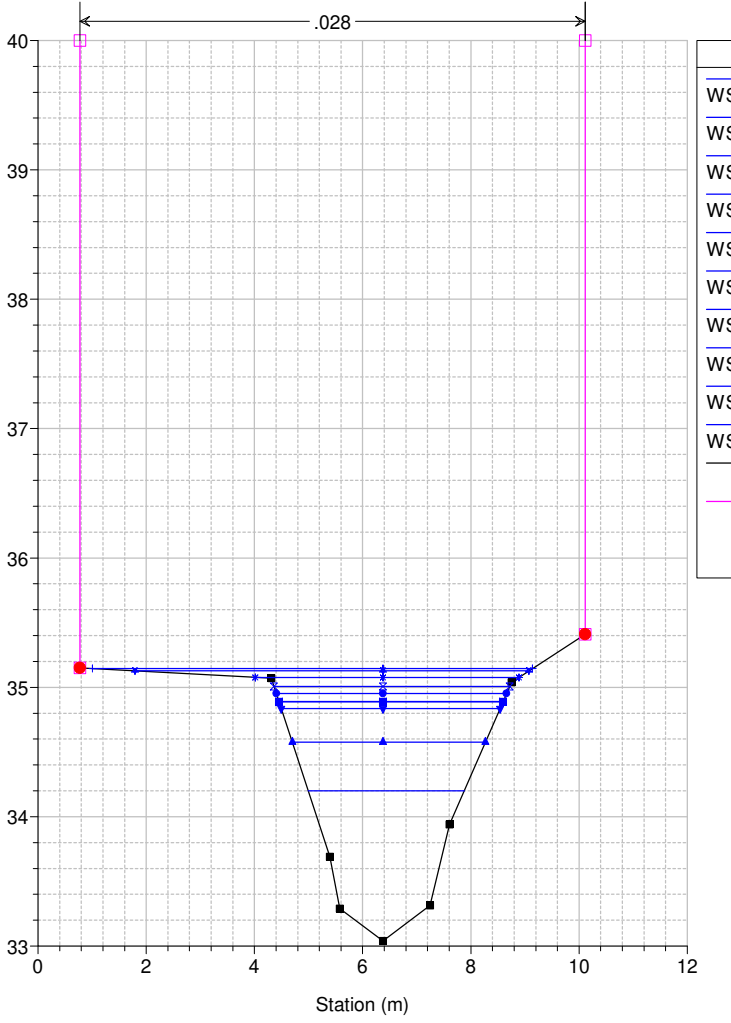

Studio Scandicci Torrenti Greve-Vingone
River = Fosso Stagnolo Reach = Stagnolo RS = 24 ST0050_B

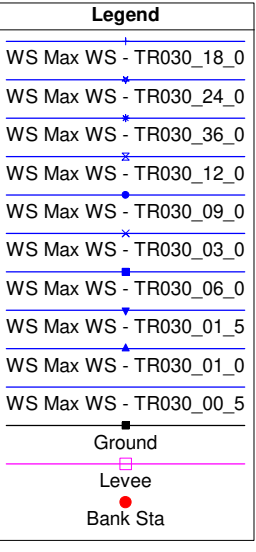
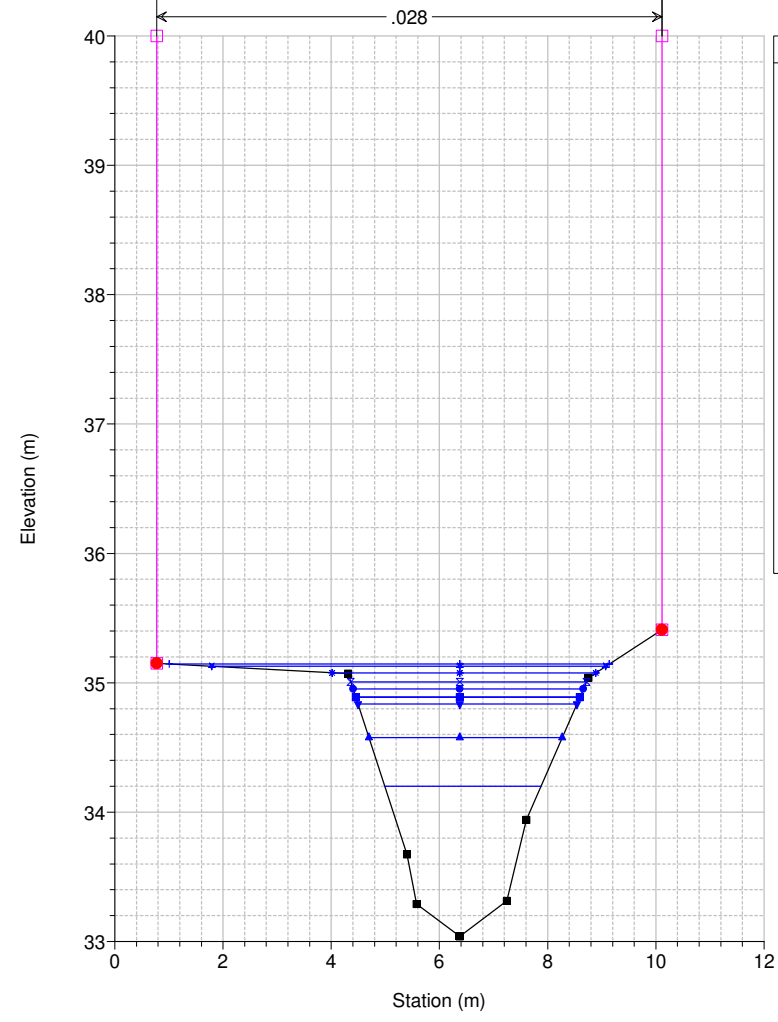

Studio Scandicci Torrenti Greve-Vingone
River = Fosso Stagnolo Reach = Stagnolo RS = 23.5 BR

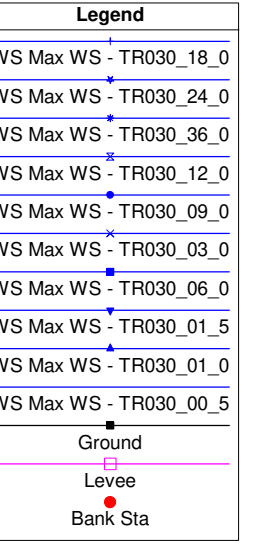
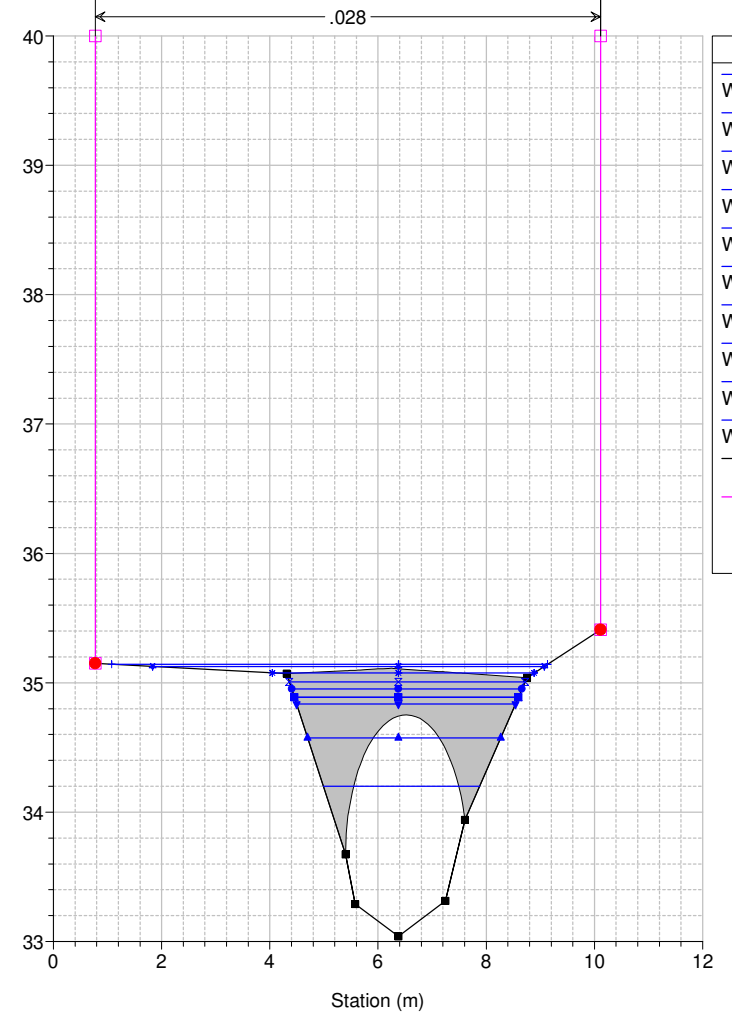

Studio Scandicci Torrenti Greve-Vingone
River = Fosso Stagnolo Reach = Stagnolo RS = 23.5 BR

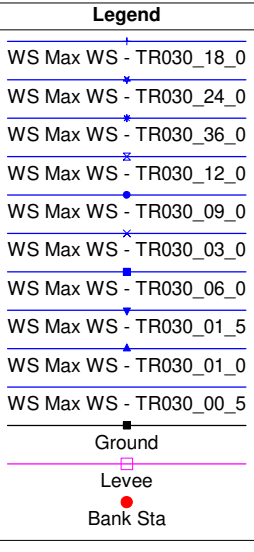
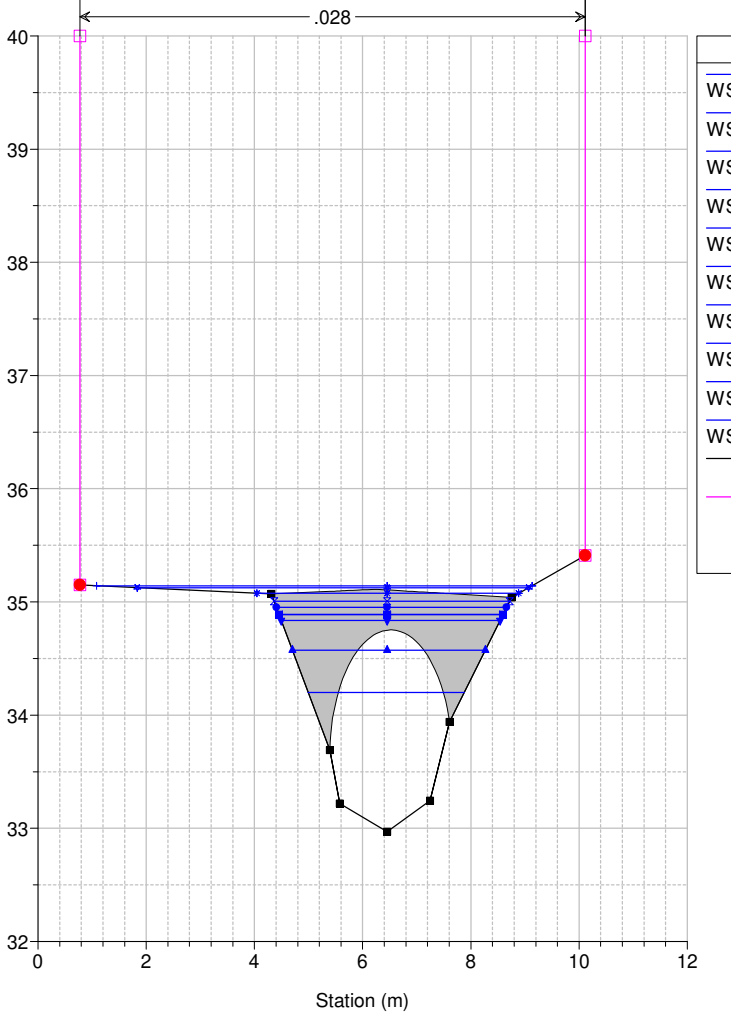

Studio Scandicci Torrenti Greve-Vingone
River = Fosso Stagnolo Reach = Stagnolo RS = 23 ST0050_C

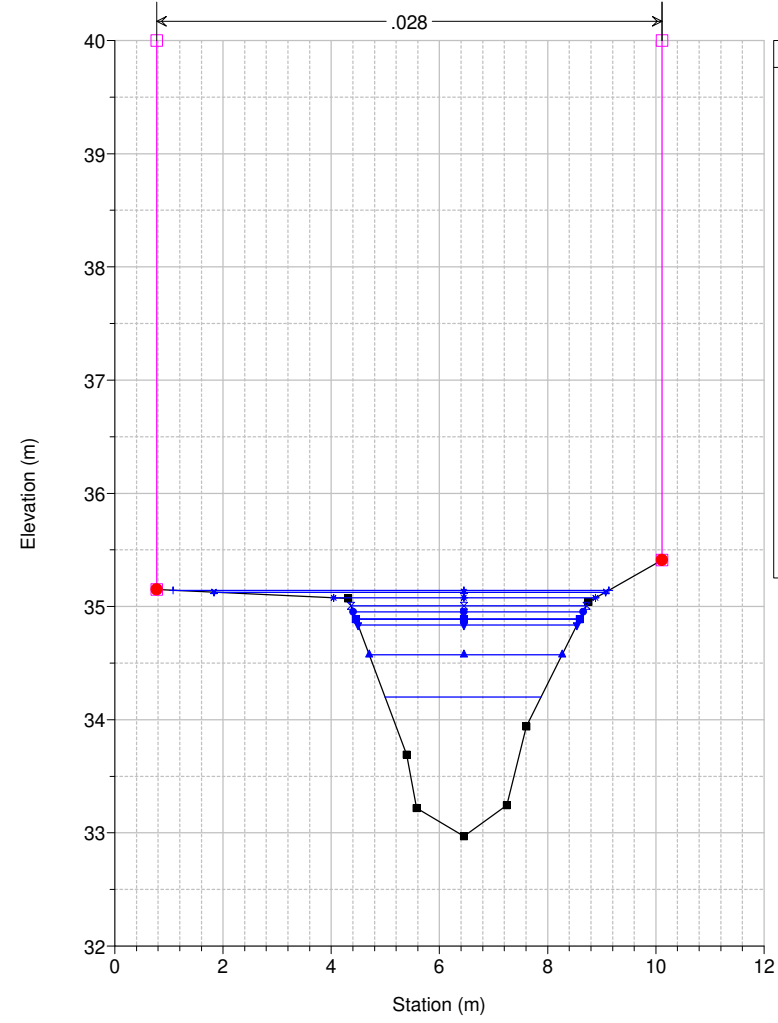

Legend	
WS Max WS - TR030_18_0	+
WS Max WS - TR030_24_0	*
WS Max WS - TR030_36_0	•
WS Max WS - TR030_12_0	x
WS Max WS - TR030_09_0	•
WS Max WS - TR030_03_0	x
WS Max WS - TR030_06_0	•
WS Max WS - TR030_01_5	v
WS Max WS - TR030_01_0	▲
WS Max WS - TR030_00_5	▲
Ground	■
Levee	□
Bank Sta	●

Studio Scandicci Torrenti Greve-Vingone
River = Fosso Stagnolo Reach = Stagnolo RS = 22 ST0050_D

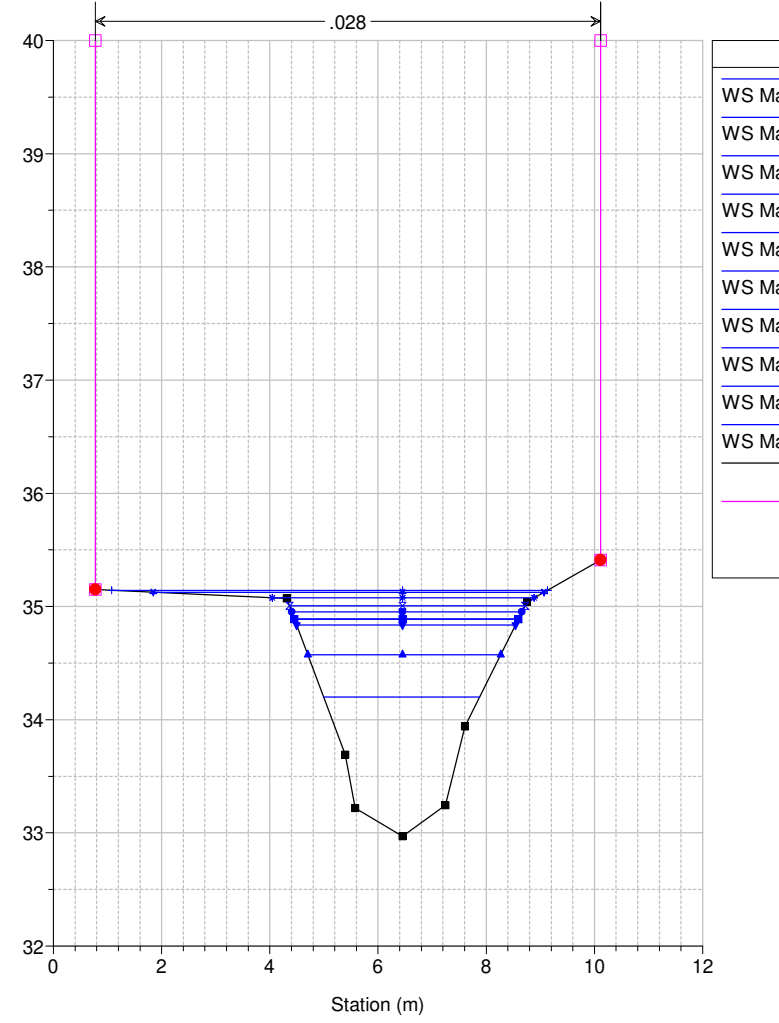

Legend	
WS Max WS - TR030_18_0	+
WS Max WS - TR030_24_0	*
WS Max WS - TR030_36_0	•
WS Max WS - TR030_12_0	x
WS Max WS - TR030_09_0	•
WS Max WS - TR030_03_0	x
WS Max WS - TR030_06_0	•
WS Max WS - TR030_01_5	v
WS Max WS - TR030_01_0	▲
WS Max WS - TR030_00_5	▲
Ground	■
Levee	□
Bank Sta	●

Studio Scandicci Torrenti Greve-Vingone
River = Fosso Stagnolo Reach = Stagnolo RS = 21 ST0051_

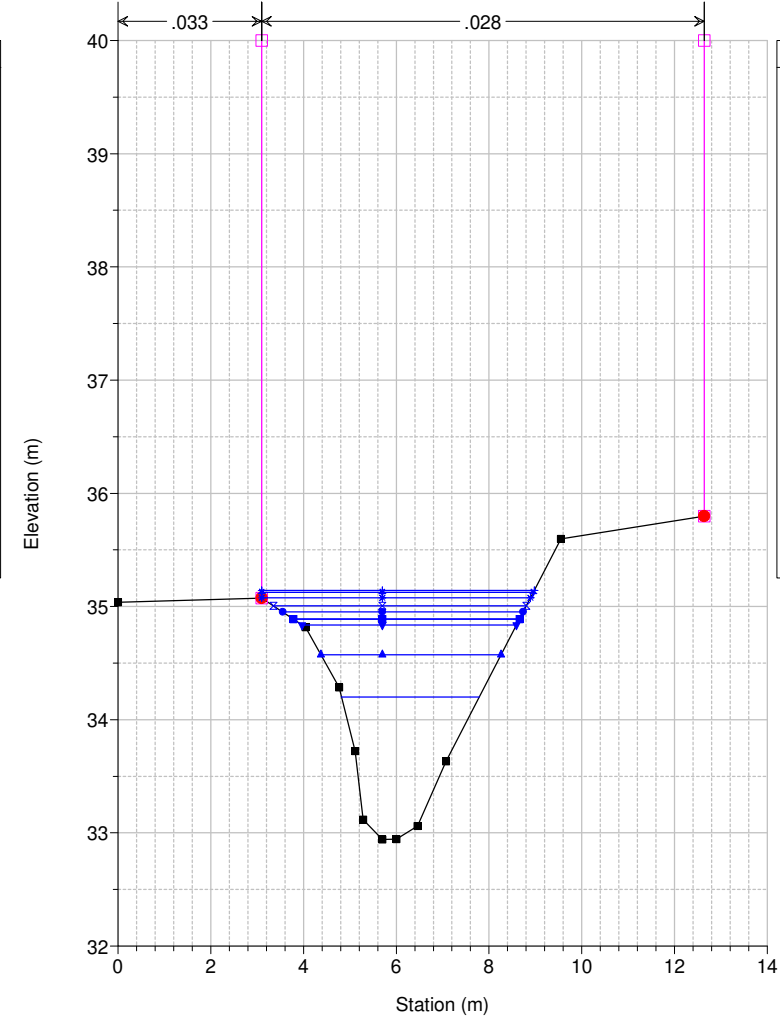

Legend	
WS Max WS - TR030_18_0	+
WS Max WS - TR030_24_0	*
WS Max WS - TR030_36_0	•
WS Max WS - TR030_12_0	x
WS Max WS - TR030_09_0	•
WS Max WS - TR030_03_0	x
WS Max WS - TR030_06_0	•
WS Max WS - TR030_01_5	v
WS Max WS - TR030_01_0	▲
WS Max WS - TR030_00_5	▲
Ground	■
Levee	□
Bank Sta	●

Studio Scandicci Torrenti Greve-Vingone
River = Fosso Stagnolo Reach = Stagnolo RS = 20 ST0052_

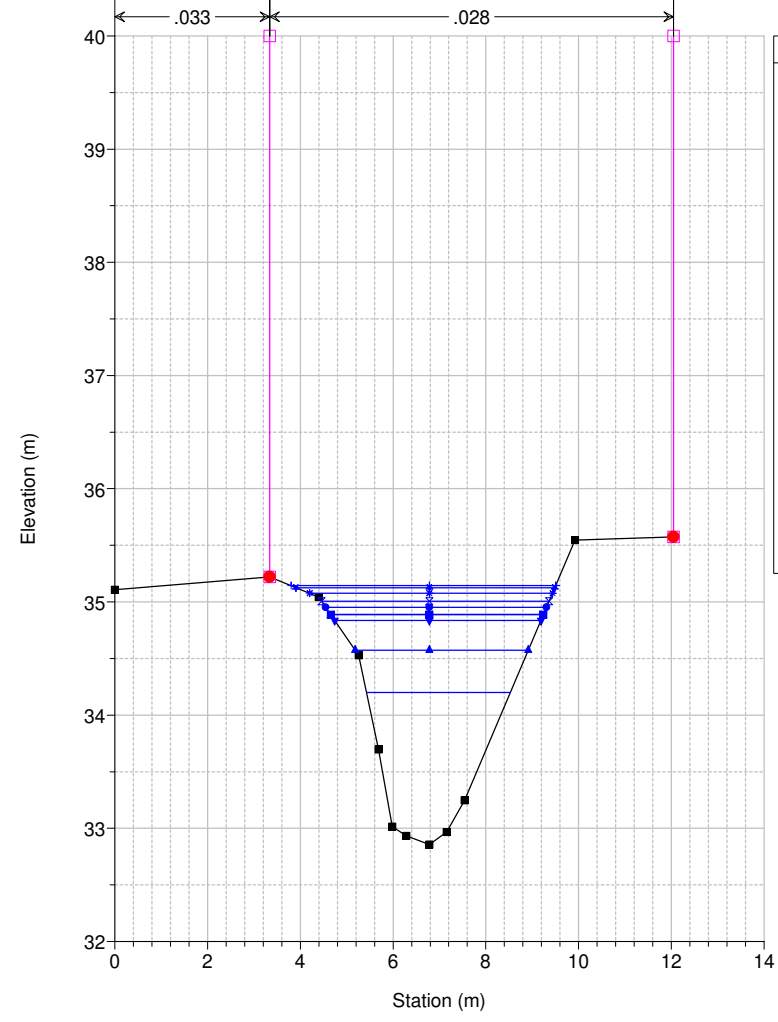

Legend	
WS Max WS - TR030_18_0	+
WS Max WS - TR030_24_0	*
WS Max WS - TR030_36_0	•
WS Max WS - TR030_12_0	x
WS Max WS - TR030_09_0	•
WS Max WS - TR030_03_0	x
WS Max WS - TR030_06_0	•
WS Max WS - TR030_01_5	v
WS Max WS - TR030_01_0	▲
WS Max WS - TR030_00_5	▲
Ground	■
Levee	□
Bank Sta	●

Studio Scandicci Torrenti Greve-Vingone
River = Fosso Stagnolo Reach = Stagnolo RS = 19 ST0053_

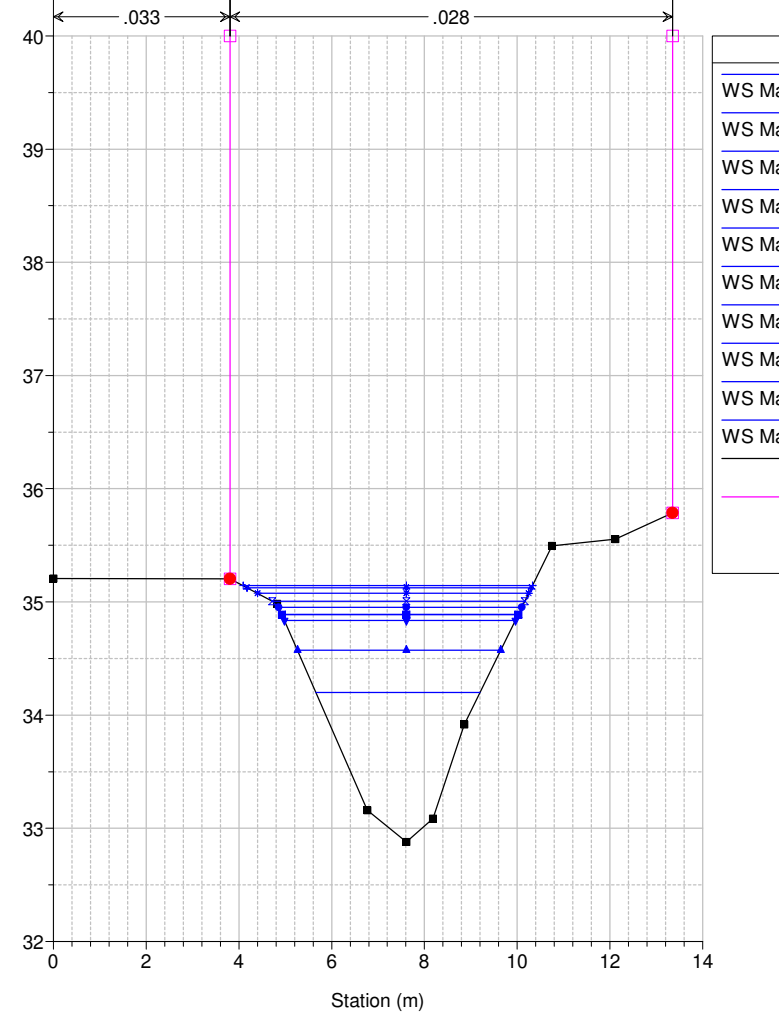

Legend	
WS Max WS - TR030_18_0	+
WS Max WS - TR030_24_0	*
WS Max WS - TR030_36_0	•
WS Max WS - TR030_12_0	x
WS Max WS - TR030_09_0	•
WS Max WS - TR030_03_0	x
WS Max WS - TR030_06_0	•
WS Max WS - TR030_01_5	v
WS Max WS - TR030_01_0	▲
WS Max WS - TR030_00_5	▲
Ground	■
Levee	□
Bank Sta	●

Studio Scandicci Torrenti Greve-Vingone
River = Fosso Stagnolo Reach = Stagnolo RS = 18 ST0054_

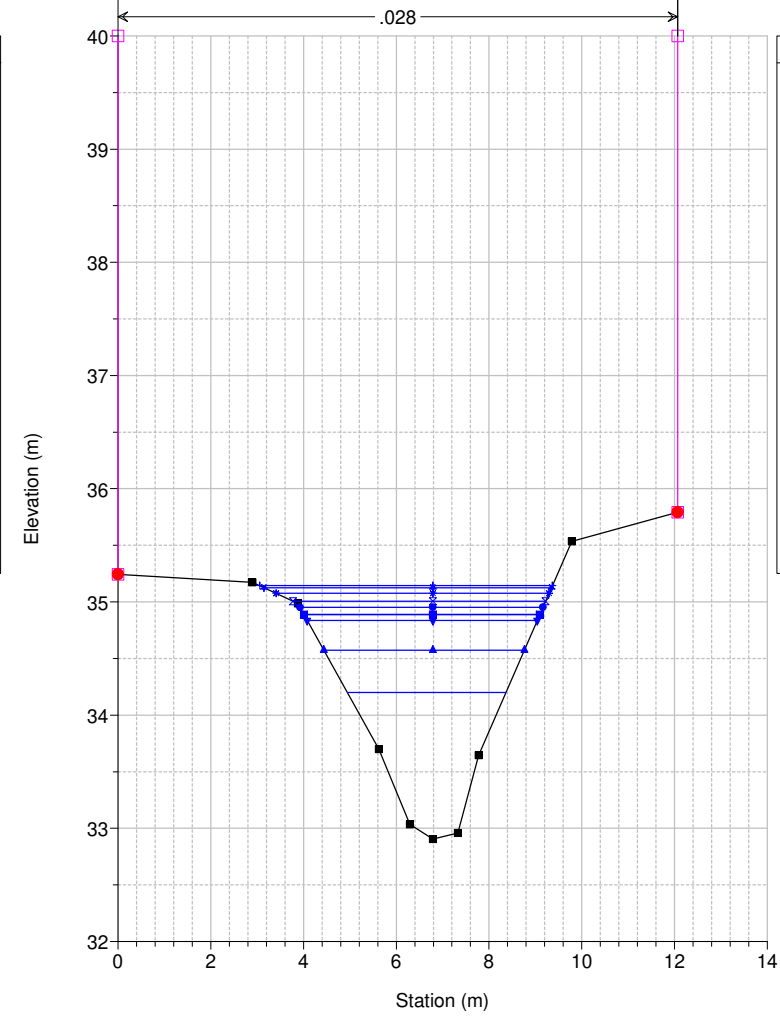

Legend	
WS Max WS - TR030_18_0	+
WS Max WS - TR030_24_0	*
WS Max WS - TR030_36_0	•
WS Max WS - TR030_12_0	x
WS Max WS - TR030_09_0	•
WS Max WS - TR030_03_0	x
WS Max WS - TR030_06_0	•
WS Max WS - TR030_01_5	v
WS Max WS - TR030_01_0	▲
WS Max WS - TR030_00_5	▲
Ground	■
Levee	□
Bank Sta	●

Studio Scandicci Torrenti Greve-Vingone
River = Fosso Stagnolo Reach = Stagnolo RS = 17 ST0055_

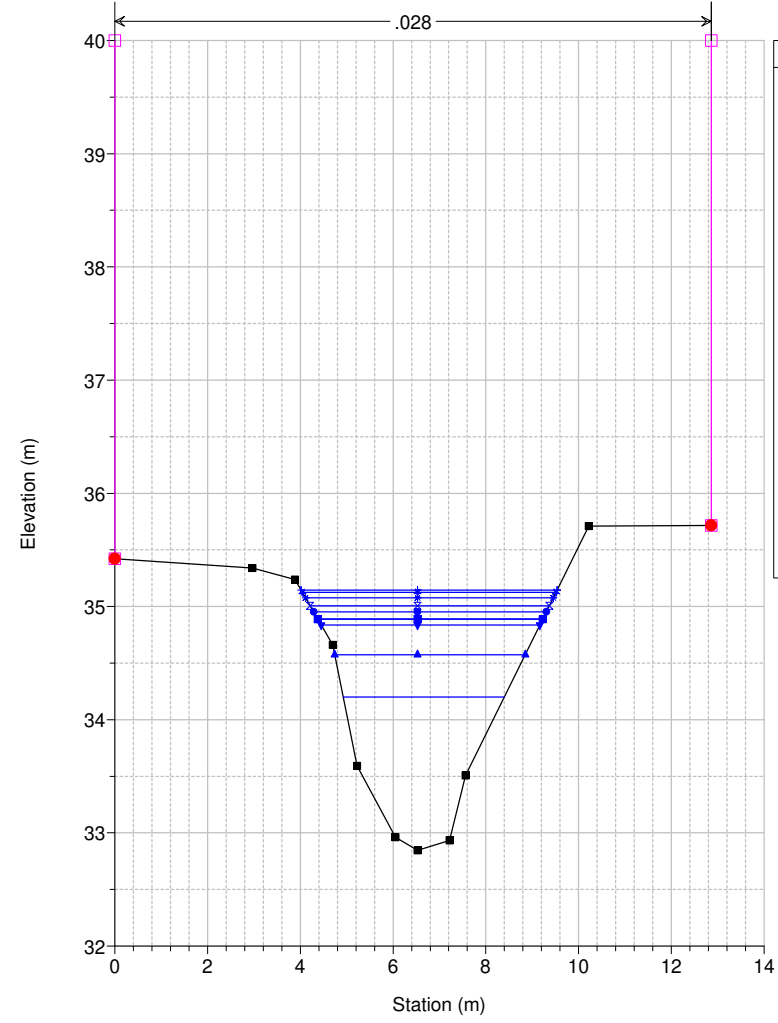

Legend	
WS Max WS - TR030_18_0	▲
WS Max WS - TR030_24_0	▼
WS Max WS - TR030_36_0	◆
WS Max WS - TR030_12_0	✕
WS Max WS - TR030_09_0	●
WS Max WS - TR030_03_0	✕
WS Max WS - TR030_06_0	■
WS Max WS - TR030_01_5	▼
WS Max WS - TR030_01_0	▲
WS Max WS - TR030_00_5	▲
Ground	■
Levee	□
Bank Sta	●

Studio Scandicci Torrenti Greve-Vingone
River = Fosso Stagnolo Reach = Stagnolo RS = 16 ST0056_

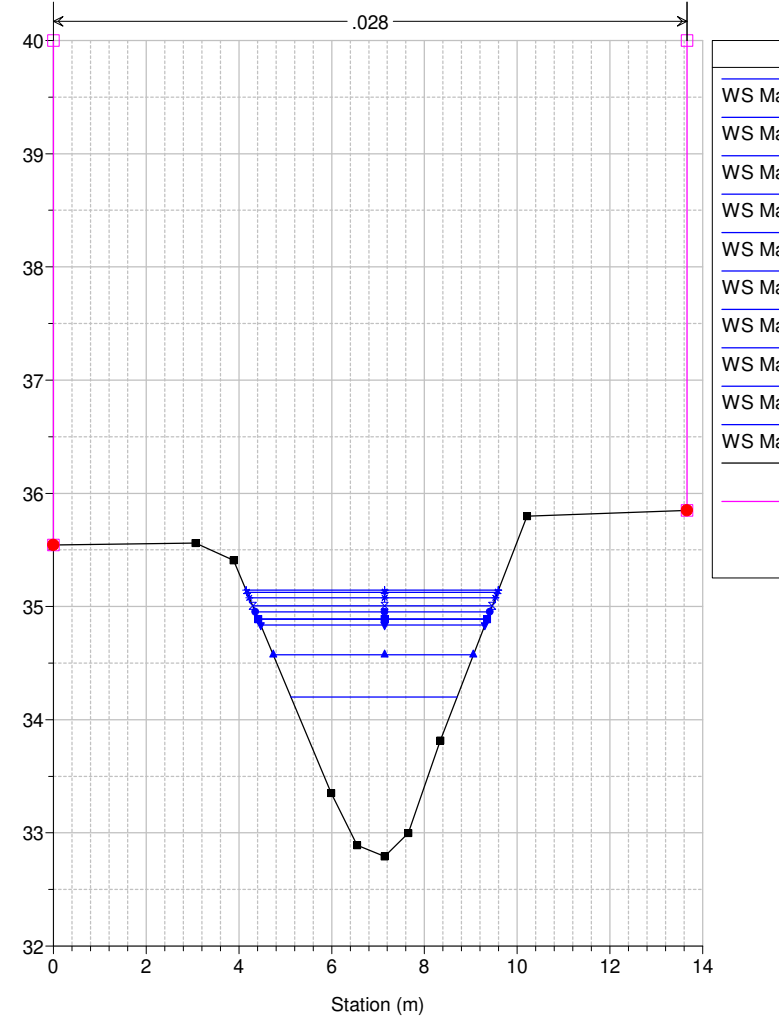

Legend	
WS Max WS - TR030_18_0	▲
WS Max WS - TR030_24_0	▼
WS Max WS - TR030_36_0	◆
WS Max WS - TR030_12_0	✕
WS Max WS - TR030_09_0	●
WS Max WS - TR030_03_0	✕
WS Max WS - TR030_06_0	■
WS Max WS - TR030_01_5	▼
WS Max WS - TR030_01_0	▲
WS Max WS - TR030_00_5	▲
Ground	■
Levee	□
Bank Sta	●

Studio Scandicci Torrenti Greve-Vingone
River = Fosso Stagnolo Reach = Stagnolo RS = 15 ST0057_A

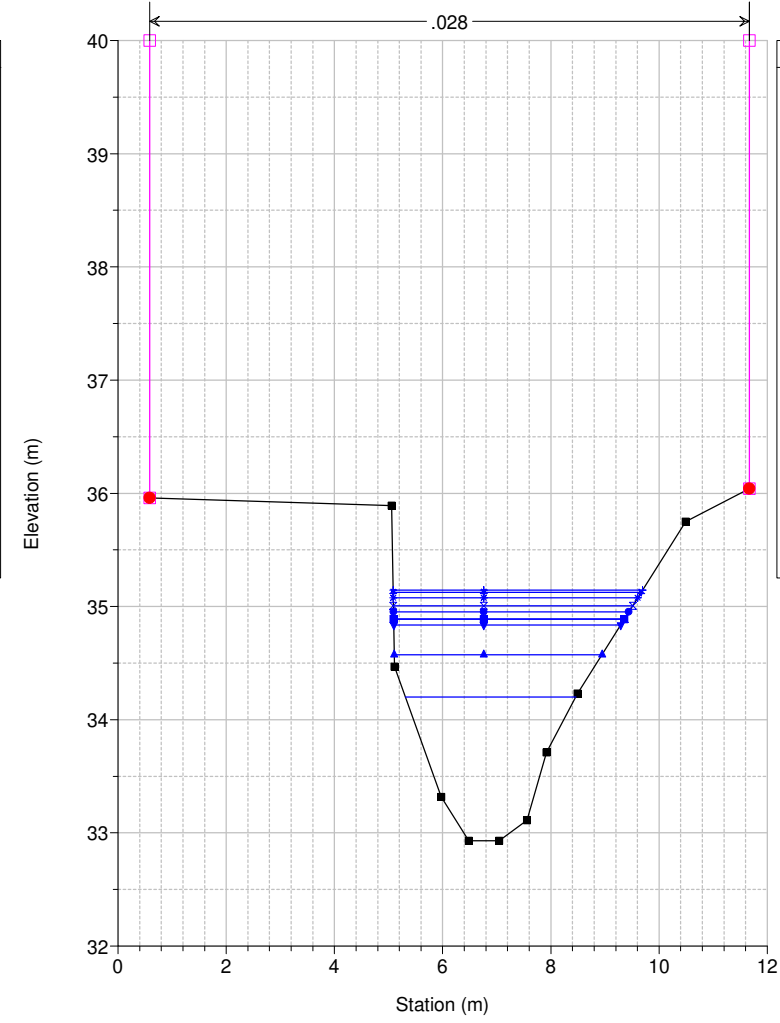

Legend	
WS Max WS - TR030_18_0	▲
WS Max WS - TR030_24_0	▼
WS Max WS - TR030_36_0	◆
WS Max WS - TR030_12_0	✕
WS Max WS - TR030_09_0	●
WS Max WS - TR030_03_0	✕
WS Max WS - TR030_06_0	■
WS Max WS - TR030_01_5	▼
WS Max WS - TR030_01_0	▲
WS Max WS - TR030_00_5	▲
Ground	■
Levee	□
Bank Sta	●

Studio Scandicci Torrenti Greve-Vingone
River = Fosso Stagnolo Reach = Stagnolo RS = 14 ST0057_B

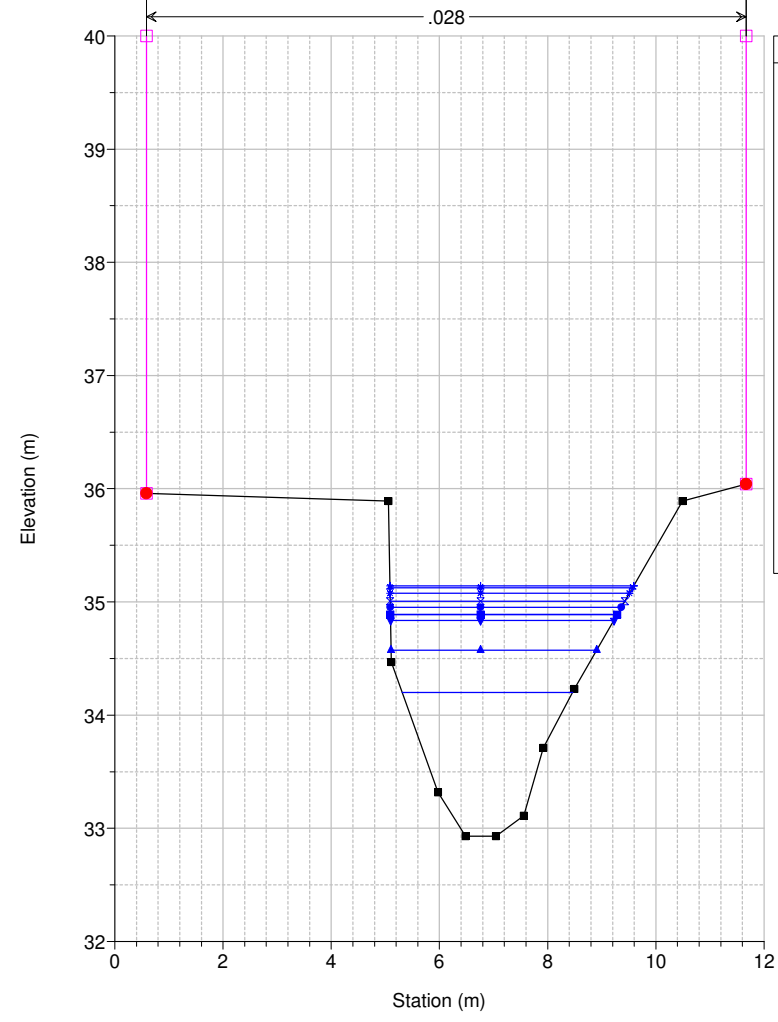

Legend	
WS Max WS - TR030_18_0	▲
WS Max WS - TR030_24_0	▼
WS Max WS - TR030_36_0	◆
WS Max WS - TR030_12_0	✕
WS Max WS - TR030_09_0	●
WS Max WS - TR030_03_0	✕
WS Max WS - TR030_06_0	■
WS Max WS - TR030_01_5	▼
WS Max WS - TR030_01_0	▲
WS Max WS - TR030_00_5	▲
Ground	■
Levee	□
Bank Sta	●

Studio Scandicci Torrenti Greve-Vingone
River = Fosso Stagnolo Reach = Stagnolo RS = 13.5 BR

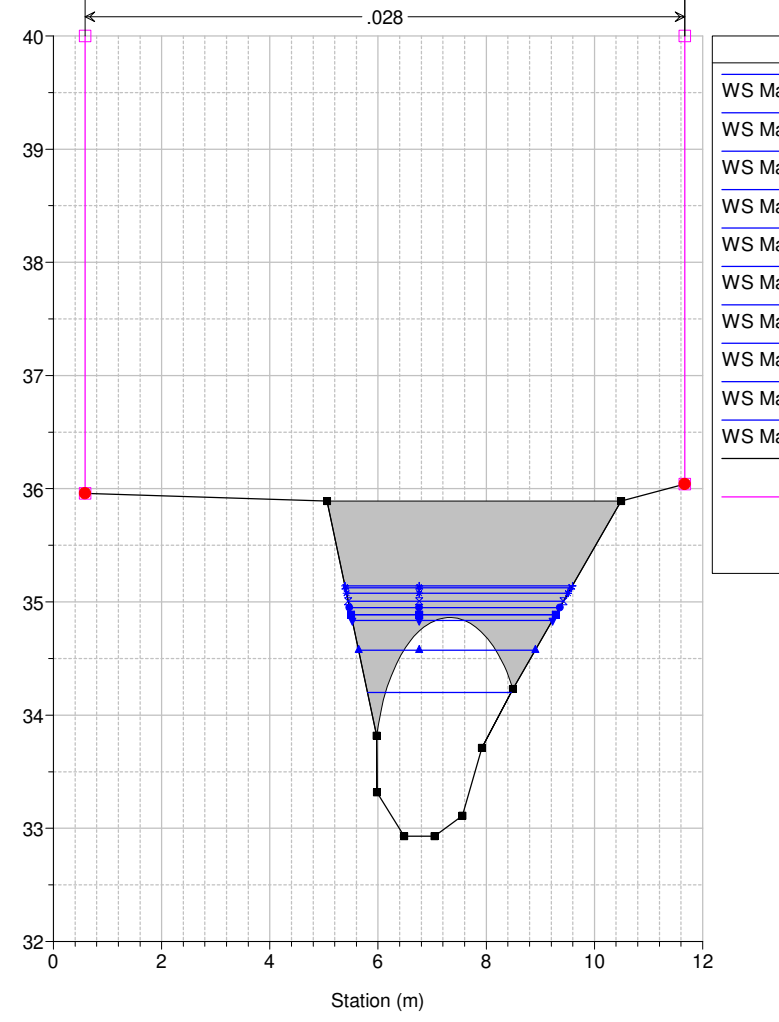

Legend	
WS Max WS - TR030_18_0	▲
WS Max WS - TR030_24_0	▼
WS Max WS - TR030_36_0	◆
WS Max WS - TR030_12_0	✕
WS Max WS - TR030_09_0	●
WS Max WS - TR030_03_0	✕
WS Max WS - TR030_06_0	■
WS Max WS - TR030_01_5	▼
WS Max WS - TR030_01_0	▲
WS Max WS - TR030_00_5	▲
Ground	■
Levee	□
Bank Sta	●

Studio Scandicci Torrenti Greve-Vingone
River = Fosso Stagnolo Reach = Stagnolo RS = 13.5 BR

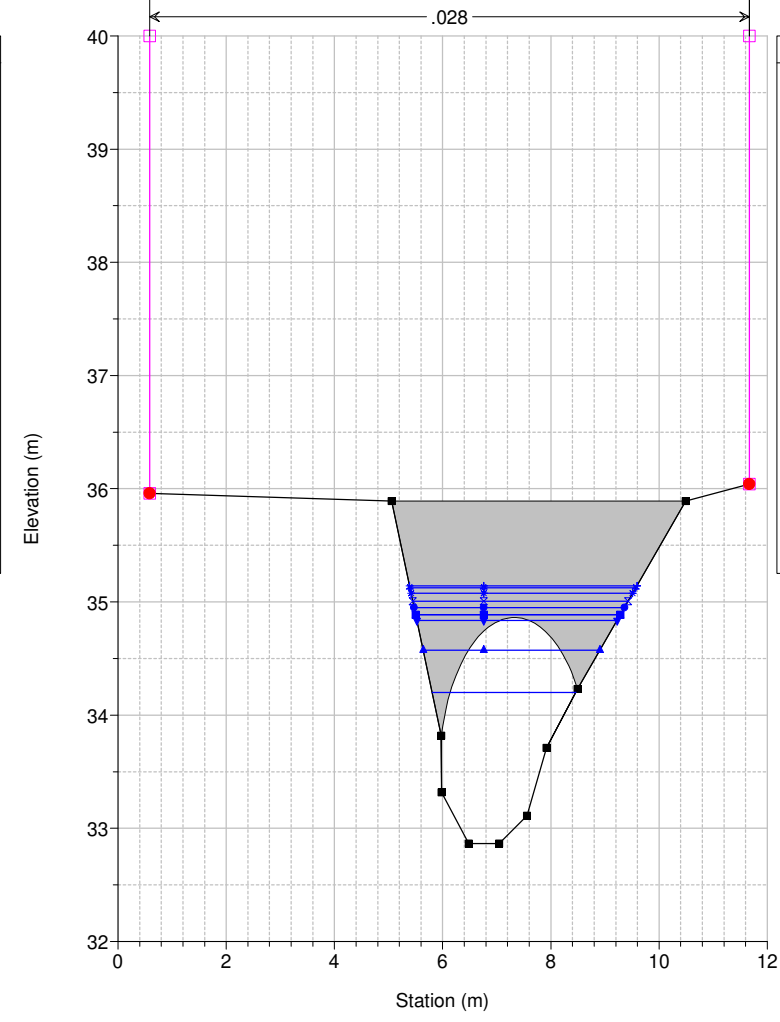

Legend	
WS Max WS - TR030_18_0	▲
WS Max WS - TR030_24_0	▼
WS Max WS - TR030_36_0	◆
WS Max WS - TR030_12_0	✕
WS Max WS - TR030_09_0	●
WS Max WS - TR030_03_0	✕
WS Max WS - TR030_06_0	■
WS Max WS - TR030_01_5	▼
WS Max WS - TR030_01_0	▲
WS Max WS - TR030_00_5	▲
Ground	■
Levee	□
Bank Sta	●

Studio Scandicci Torrenti Greve-Vingone
River = Fosso Stagnolo Reach = Stagnolo RS = 13 ST0057_C

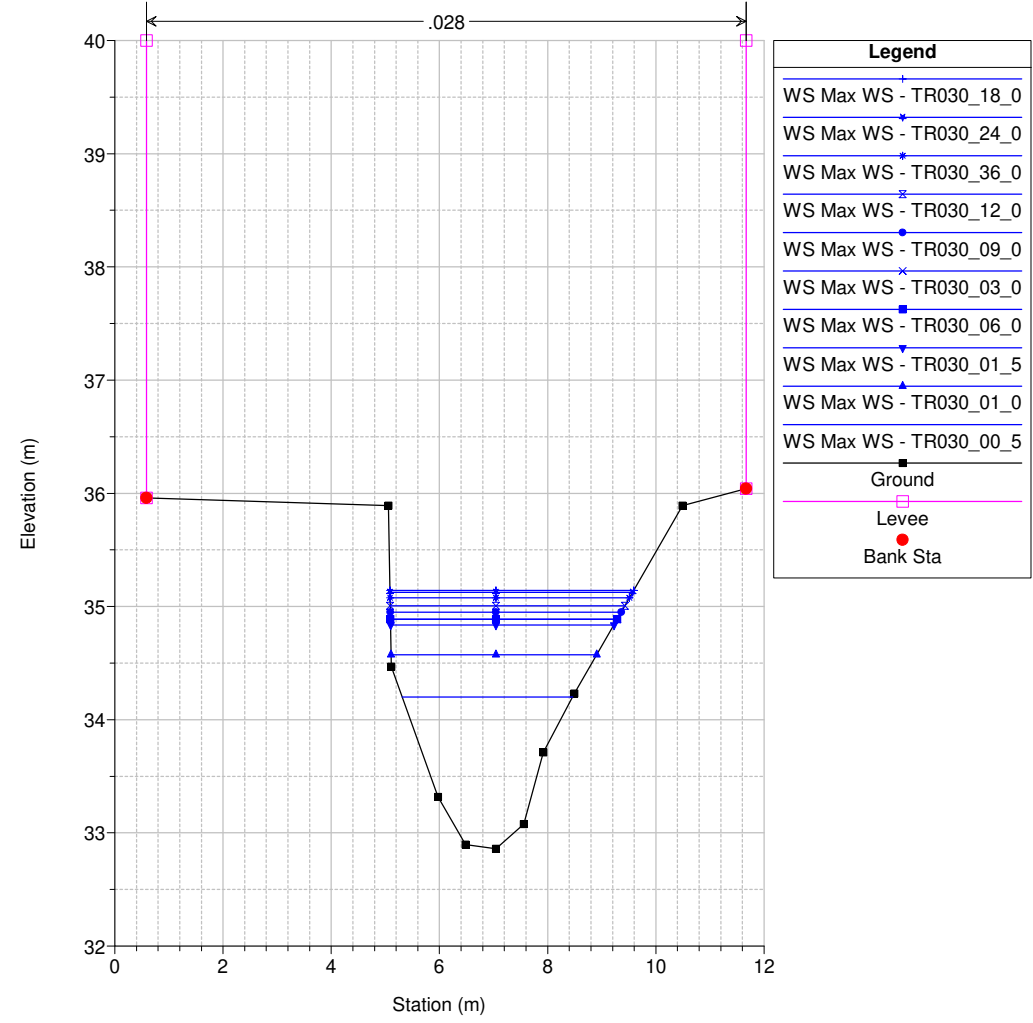

Studio Scandicci Torrenti Greve-Vingone
River = Fosso Stagnolo Reach = Stagnolo RS = 12 ST0057_D

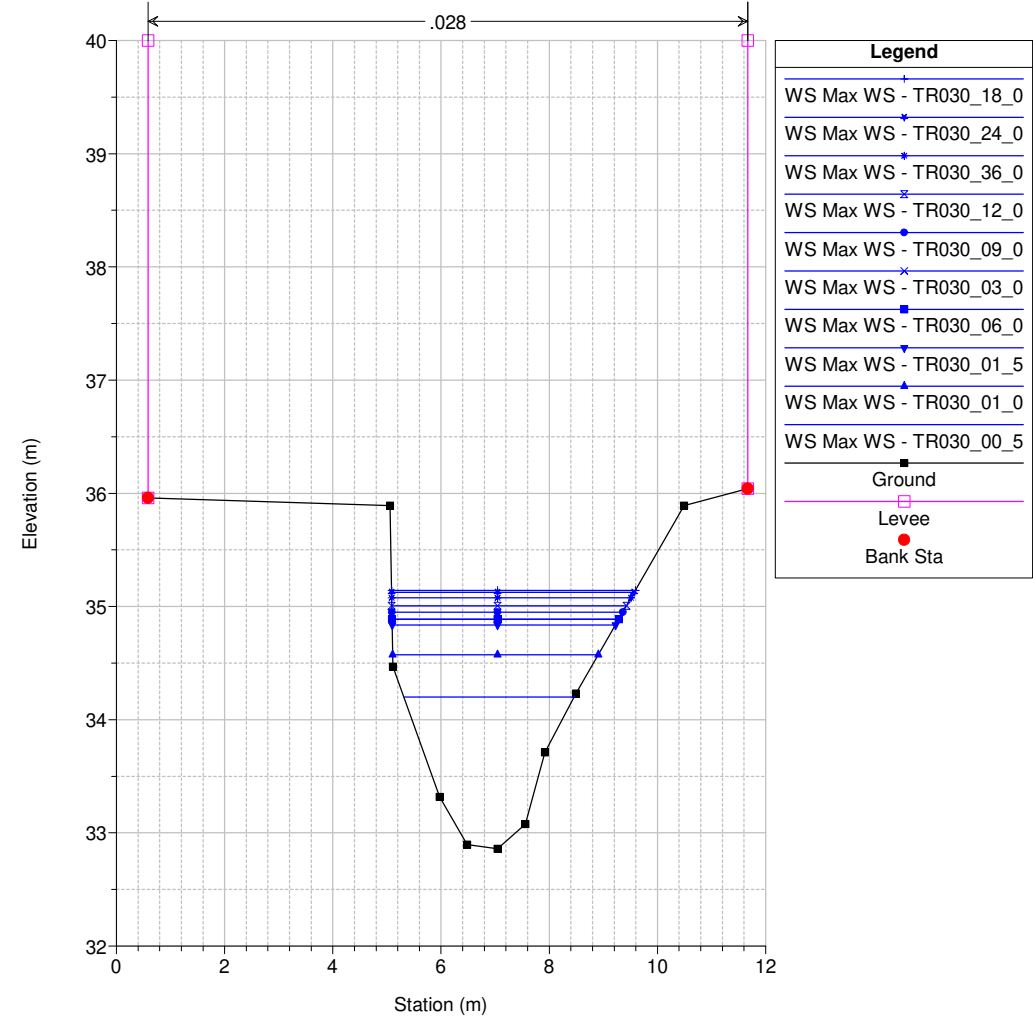

Studio Scandicci Torrenti Greve-Vingone
River = Fosso Stagnolo Reach = Stagnolo RS = 11 ST0058__

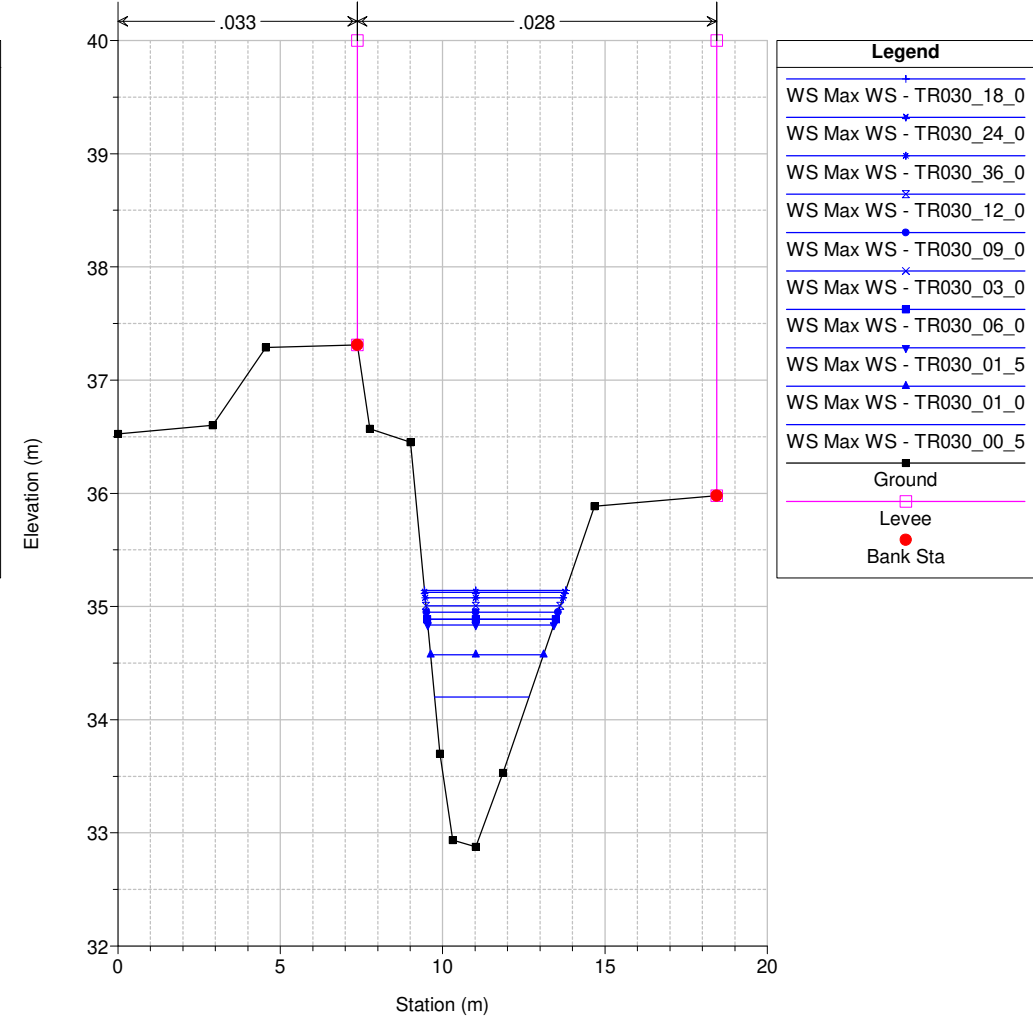

Studio Scandicci Torrenti Greve-Vingone
River = Fosso Stagnolo Reach = Stagnolo RS = 10 ST0059__

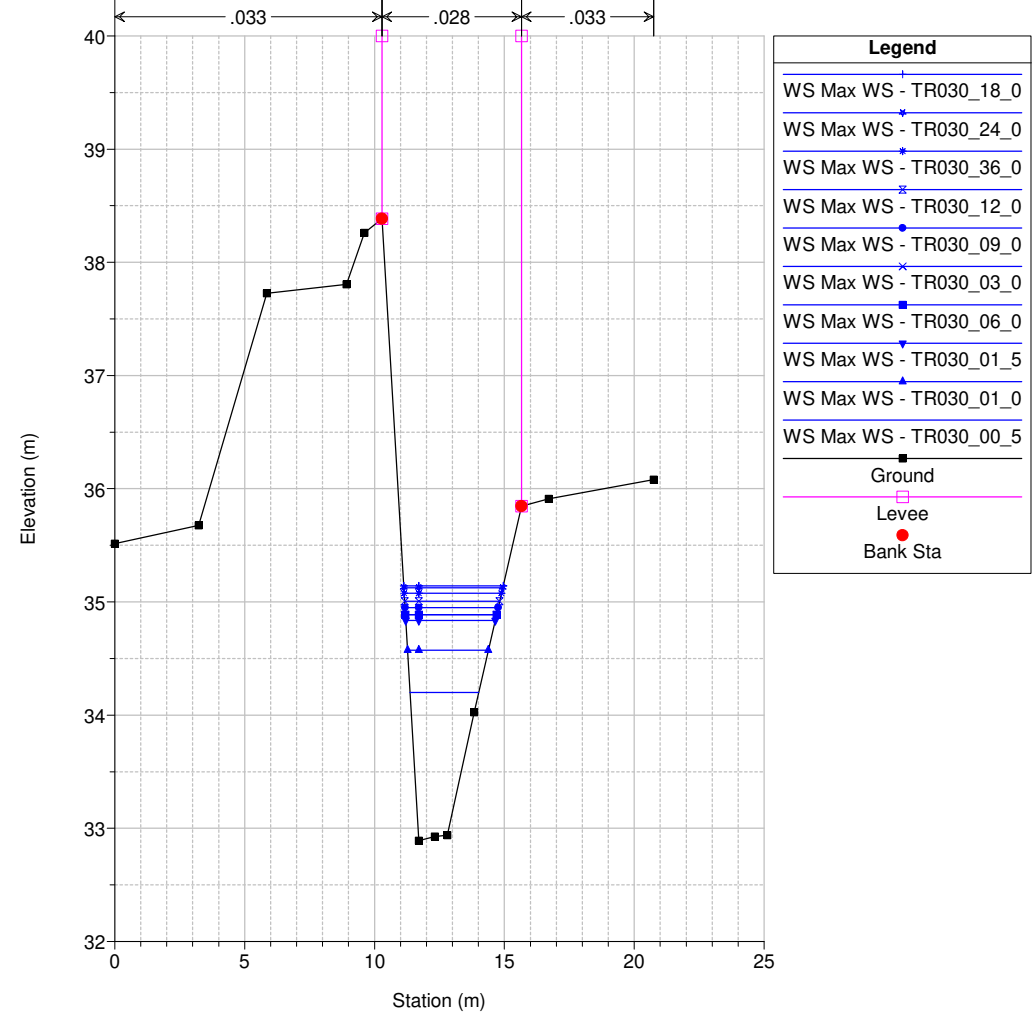

Studio Scandicci Torrenti Greve-Vingone
River = Fosso Stagnolo Reach = Stagnolo RS = 9 ST0060_A

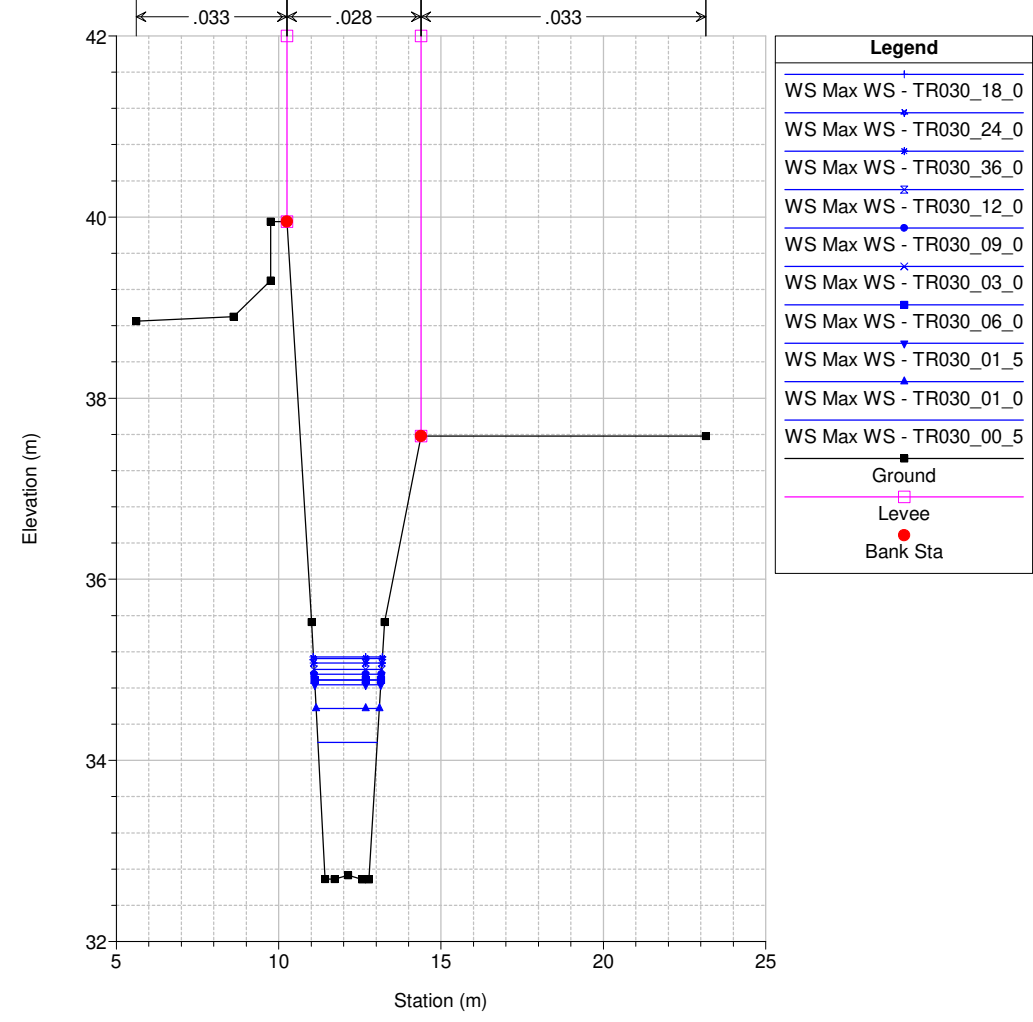

Studio Scandicci Torrenti Greve-Vingone
River = Fosso Stagnolo Reach = Stagnolo RS = 8 ST0060_B

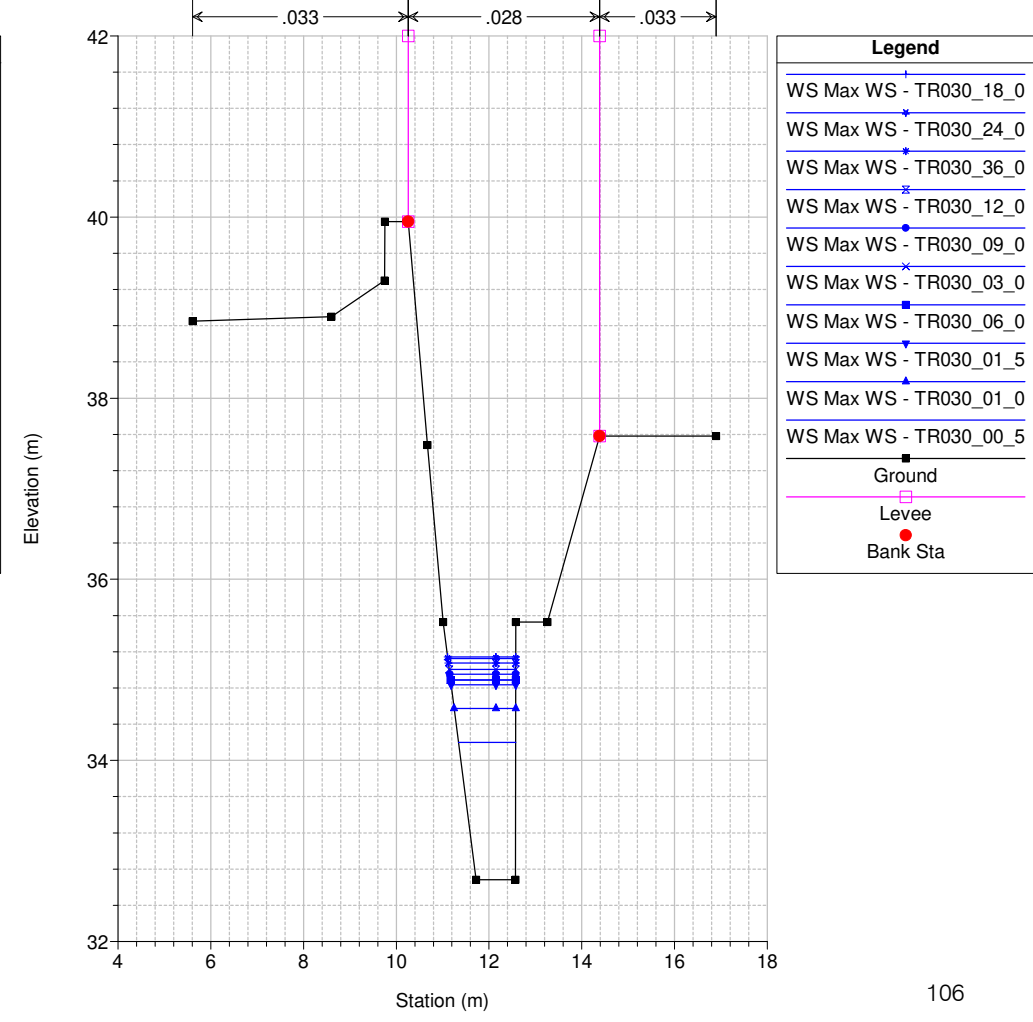

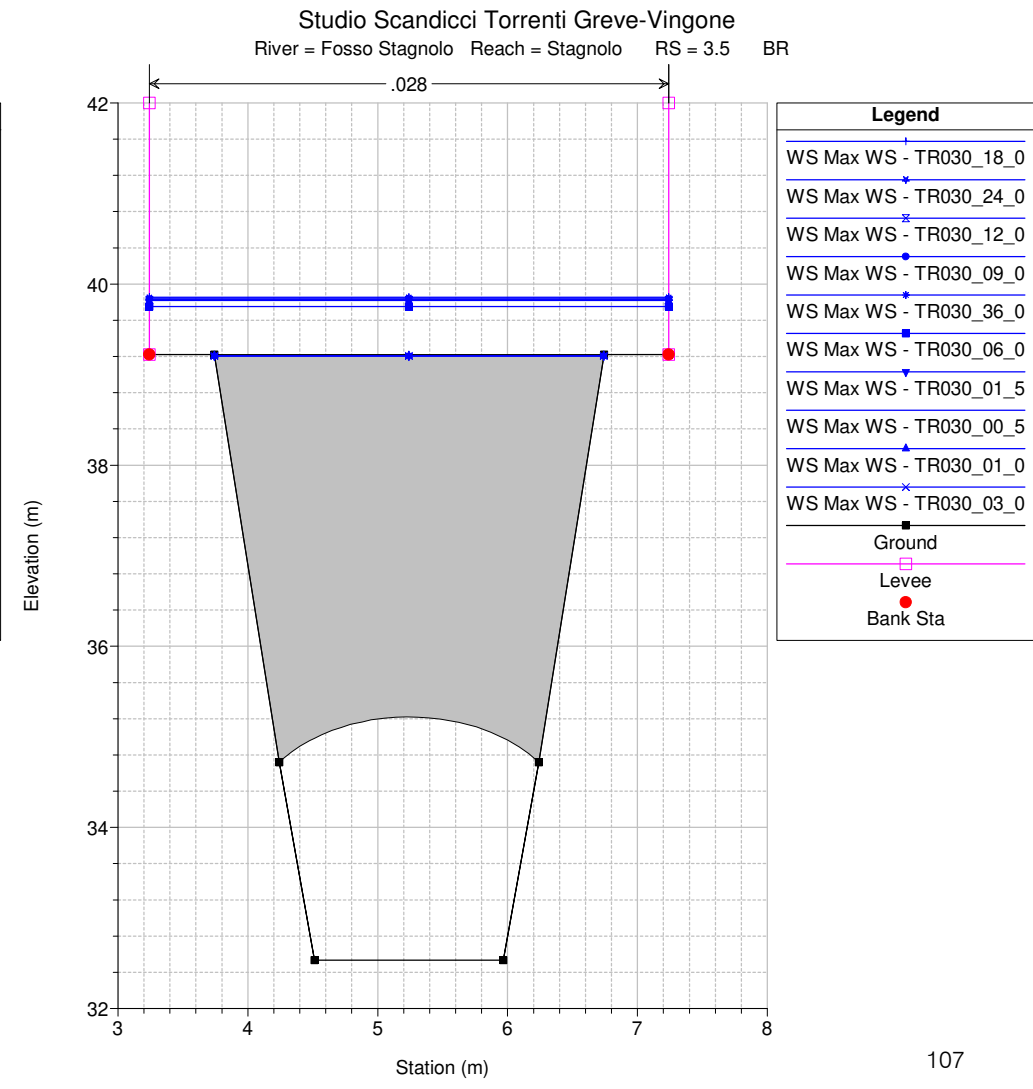
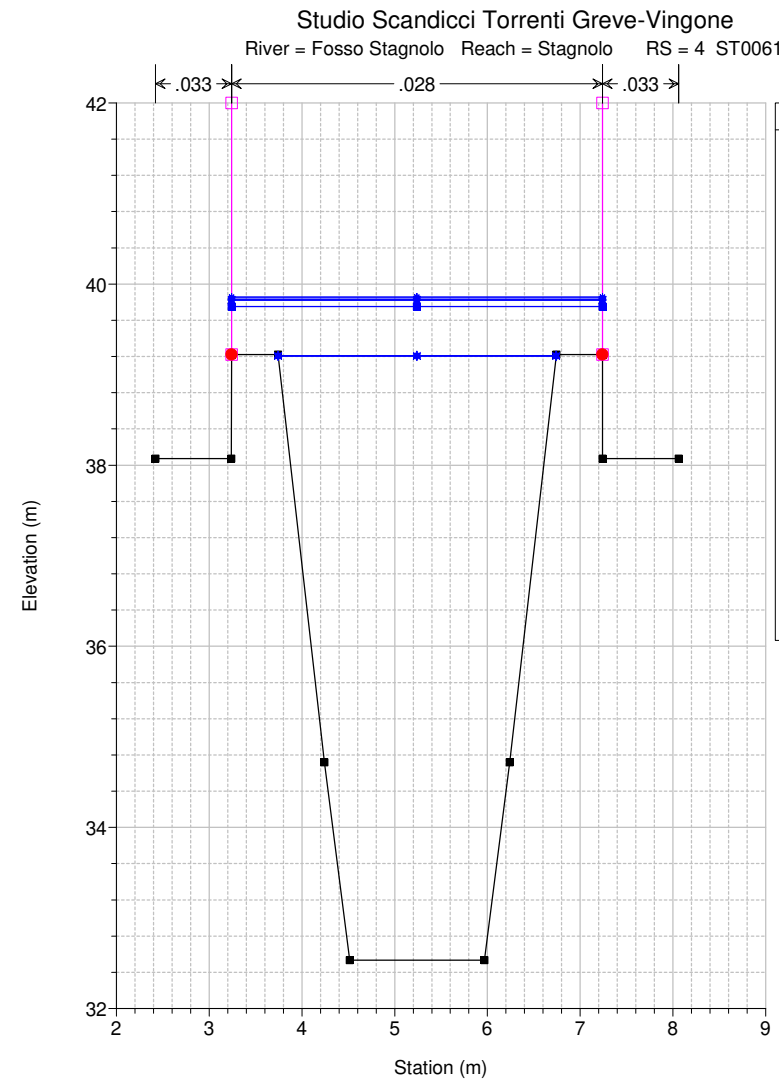
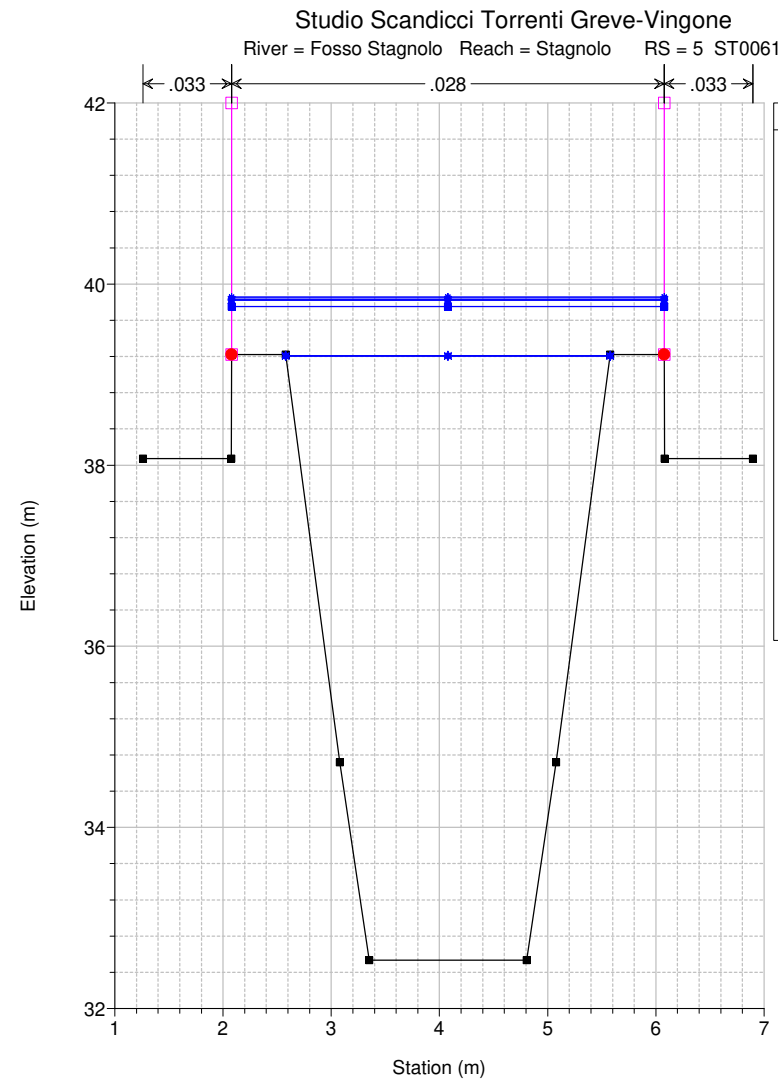
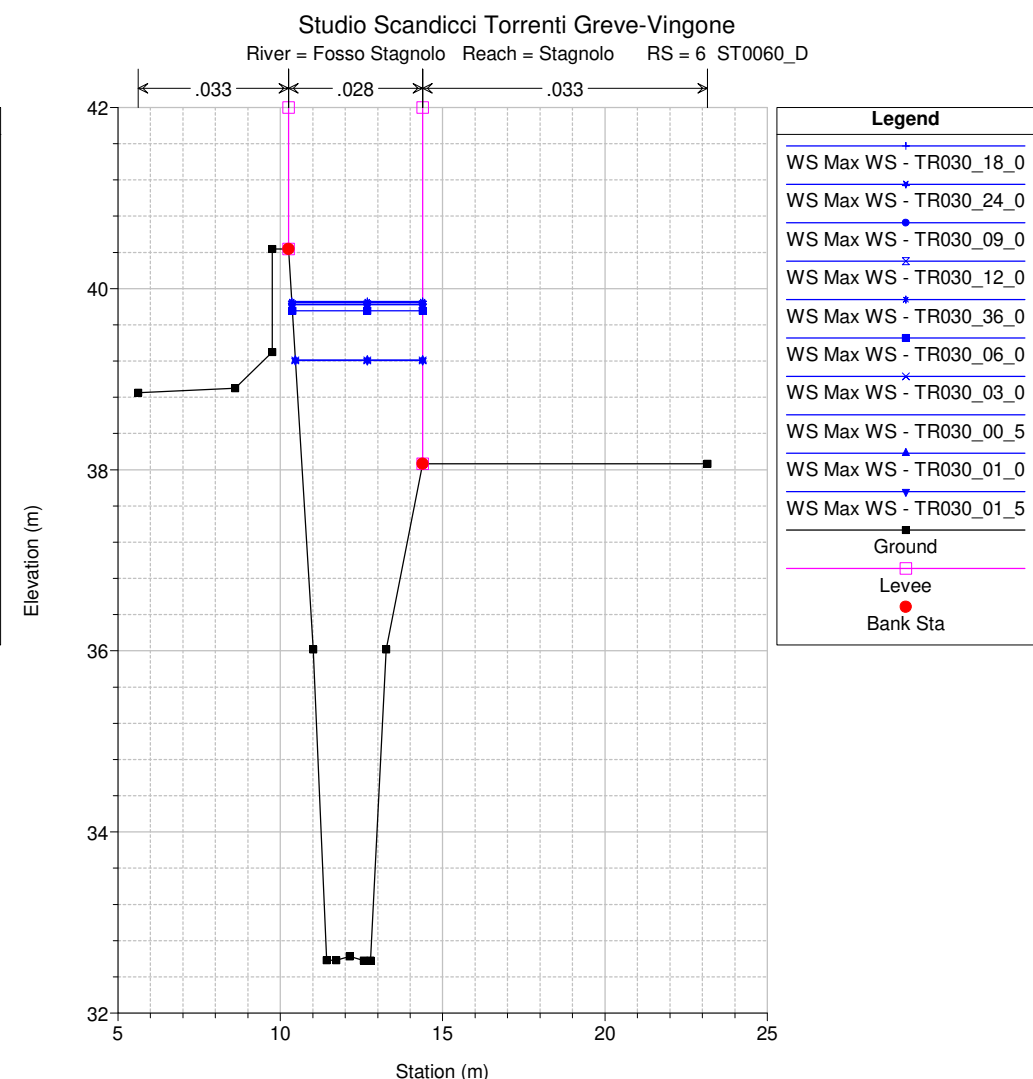
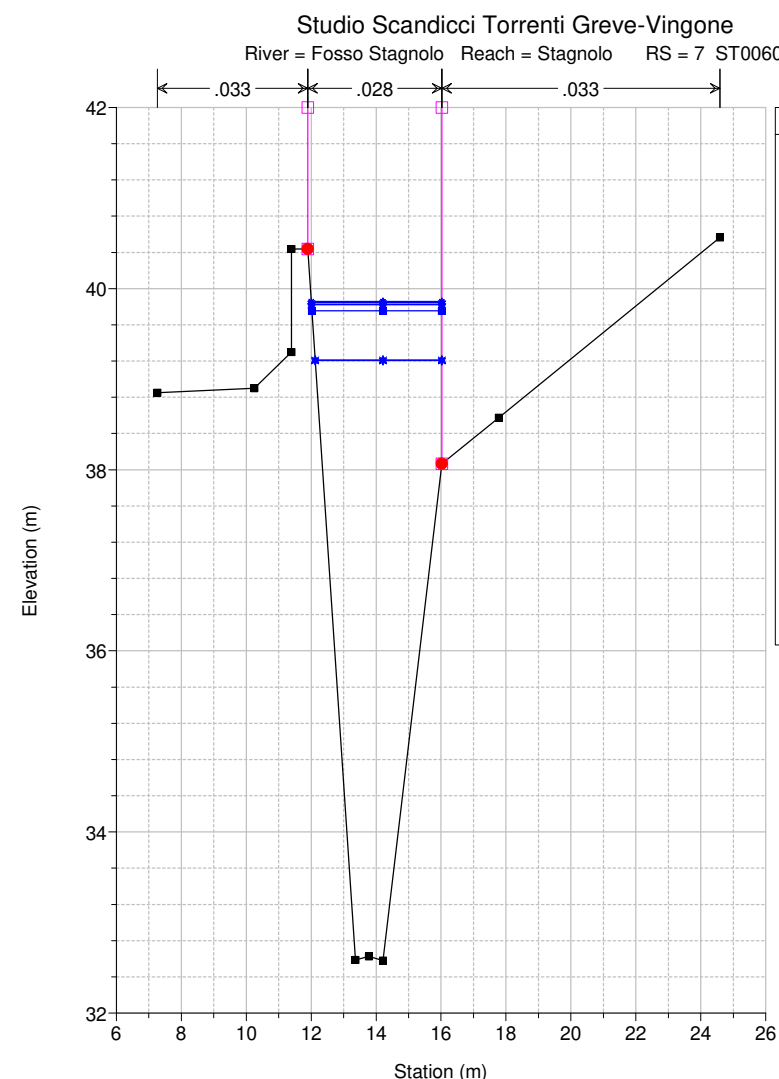
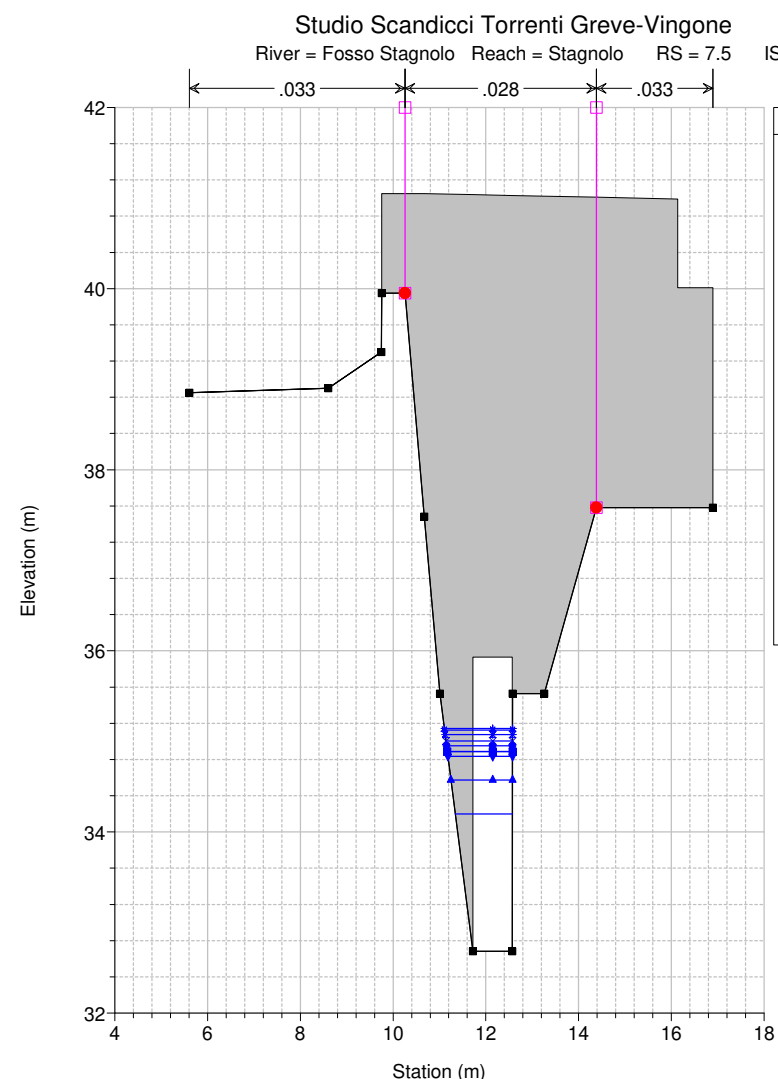

Studio Scandicci Torrenti Greve-Vingone
River = Fosso Stagnolo Reach = Stagnolo RS = 3.5 BR

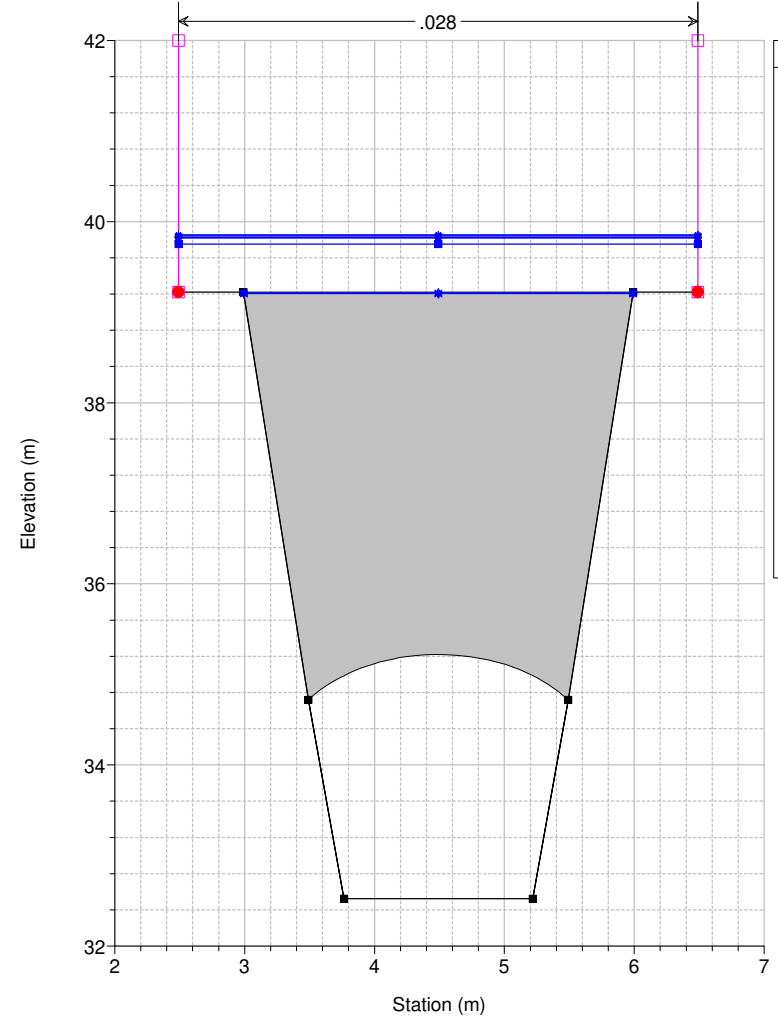

Legend

- WS Max WS - TR030_18_0
- WS Max WS - TR030_24_0
- WS Max WS - TR030_09_0
- WS Max WS - TR030_12_0
- WS Max WS - TR030_36_0
- WS Max WS - TR030_06_0
- WS Max WS - TR030_03_0
- WS Max WS - TR030_00_5
- WS Max WS - TR030_01_0
- WS Max WS - TR030_01_5
- Ground
- Levee
- Bank Sta

Studio Scandicci Torrenti Greve-Vingone
River = Fosso Stagnolo Reach = Stagnolo RS = 3 ST0061_C

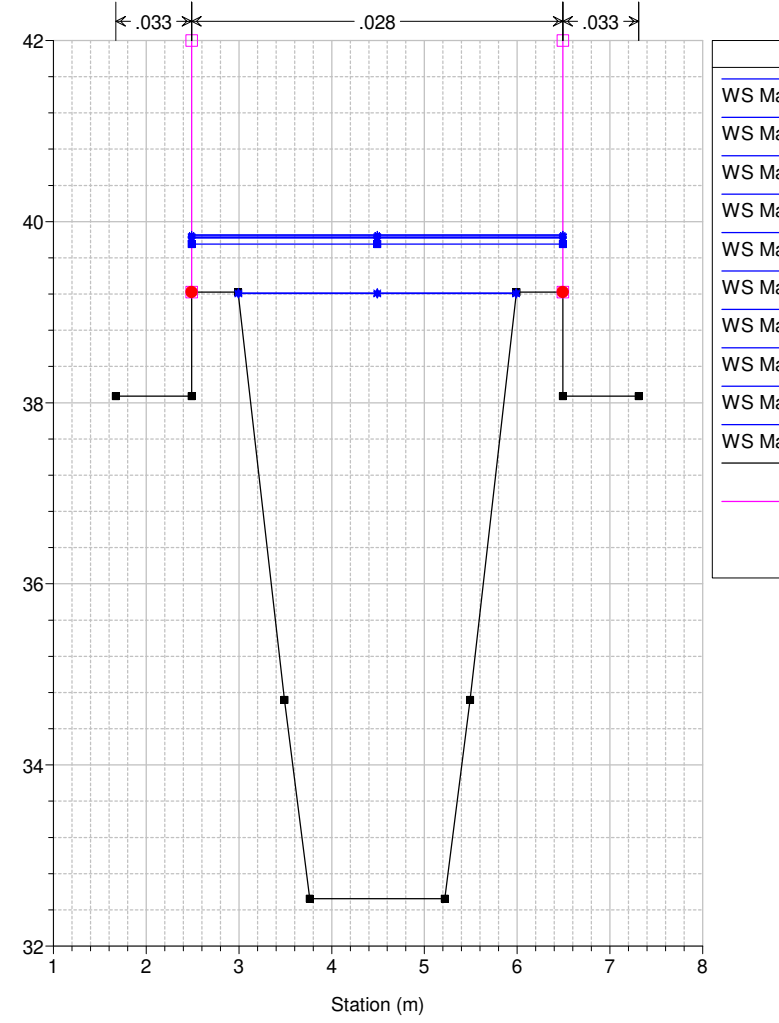

Legend

- WS Max WS - TR030_18_0
- WS Max WS - TR030_24_0
- WS Max WS - TR030_09_0
- WS Max WS - TR030_12_0
- WS Max WS - TR030_36_0
- WS Max WS - TR030_06_0
- WS Max WS - TR030_03_0
- WS Max WS - TR030_00_5
- WS Max WS - TR030_01_0
- WS Max WS - TR030_01_5
- Ground
- Levee
- Bank Sta

Studio Scandicci Torrenti Greve-Vingone
River = Fosso Stagnolo Reach = Stagnolo RS = 2 ST0061_D

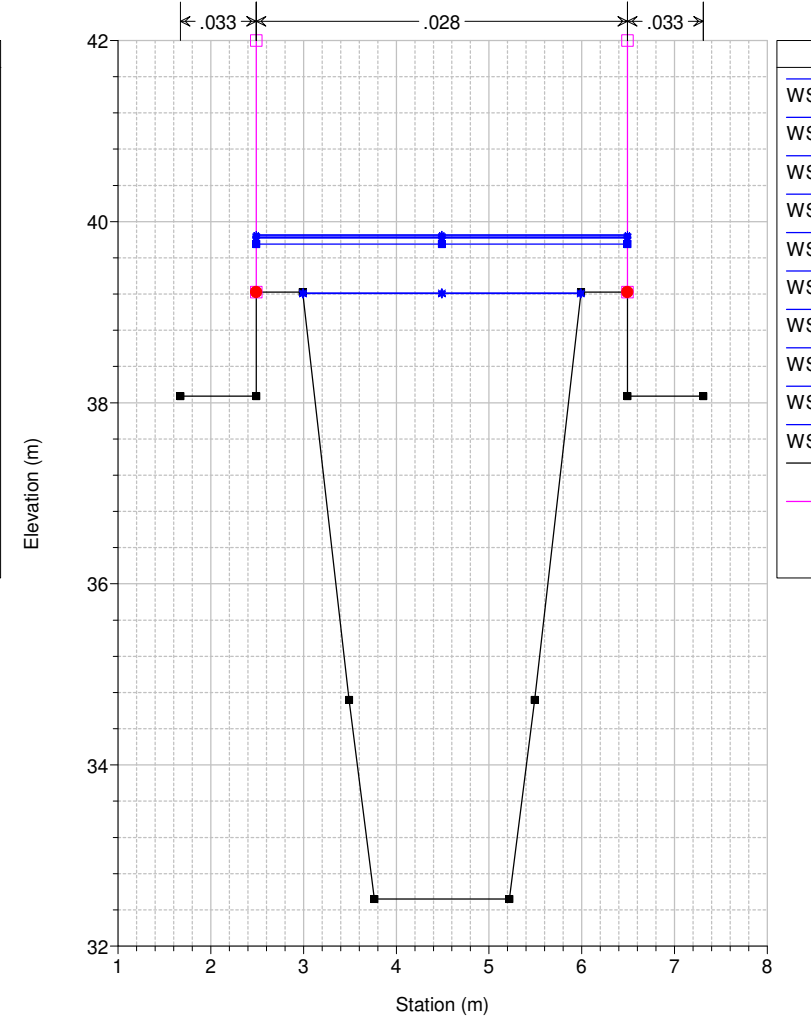

Legend

- WS Max WS - TR030_18_0
- WS Max WS - TR030_24_0
- WS Max WS - TR030_09_0
- WS Max WS - TR030_12_0
- WS Max WS - TR030_36_0
- WS Max WS - TR030_06_0
- WS Max WS - TR030_03_0
- WS Max WS - TR030_00_5
- WS Max WS - TR030_01_0
- WS Max WS - TR030_01_5
- Ground
- Levee
- Bank Sta

Studio Scandicci Torrenti Greve-Vingone
River = Fosso Stagnolo Reach = Stagnolo RS = 1 ST0062_

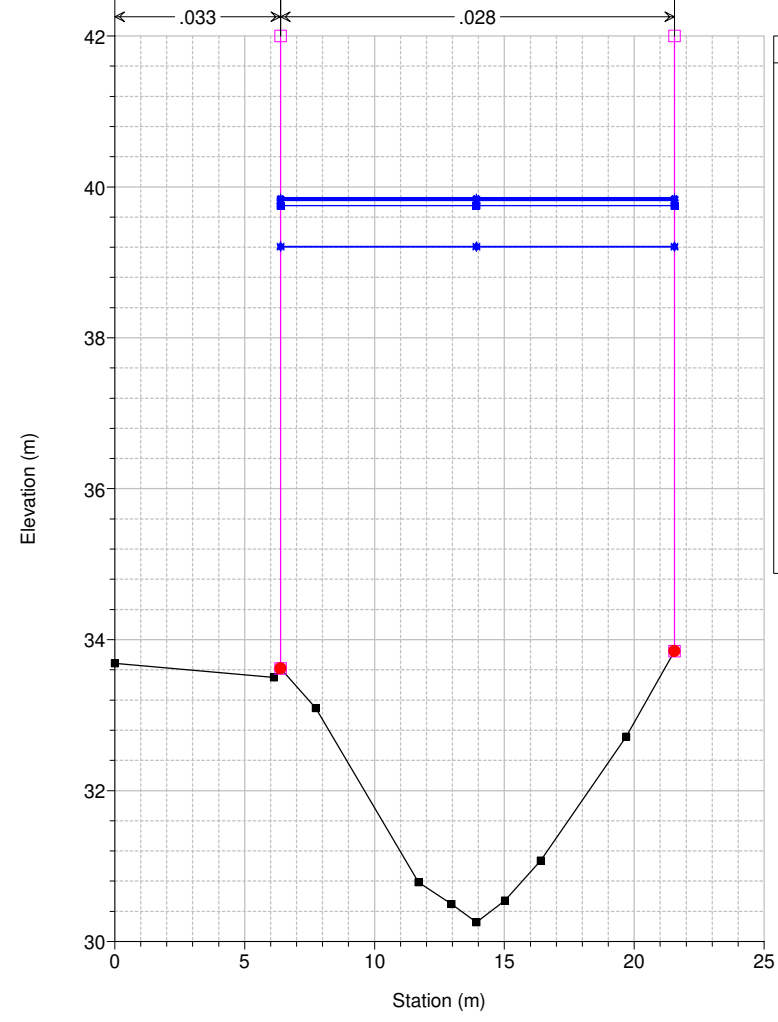

Legend

- WS Max WS - TR030_18_0
- WS Max WS - TR030_24_0
- WS Max WS - TR030_09_0
- WS Max WS - TR030_12_0
- WS Max WS - TR030_36_0
- WS Max WS - TR030_06_0
- WS Max WS - TR030_03_0
- WS Max WS - TR030_00_5
- WS Max WS - TR030_01_0
- WS Max WS - TR030_01_5
- Ground
- Levee
- Bank Sta

Studio Scandicci Torrenti Greve-Vingone
River = Fosso Stagnolo Reach = Stagnolo RS = 0.5 AR0517

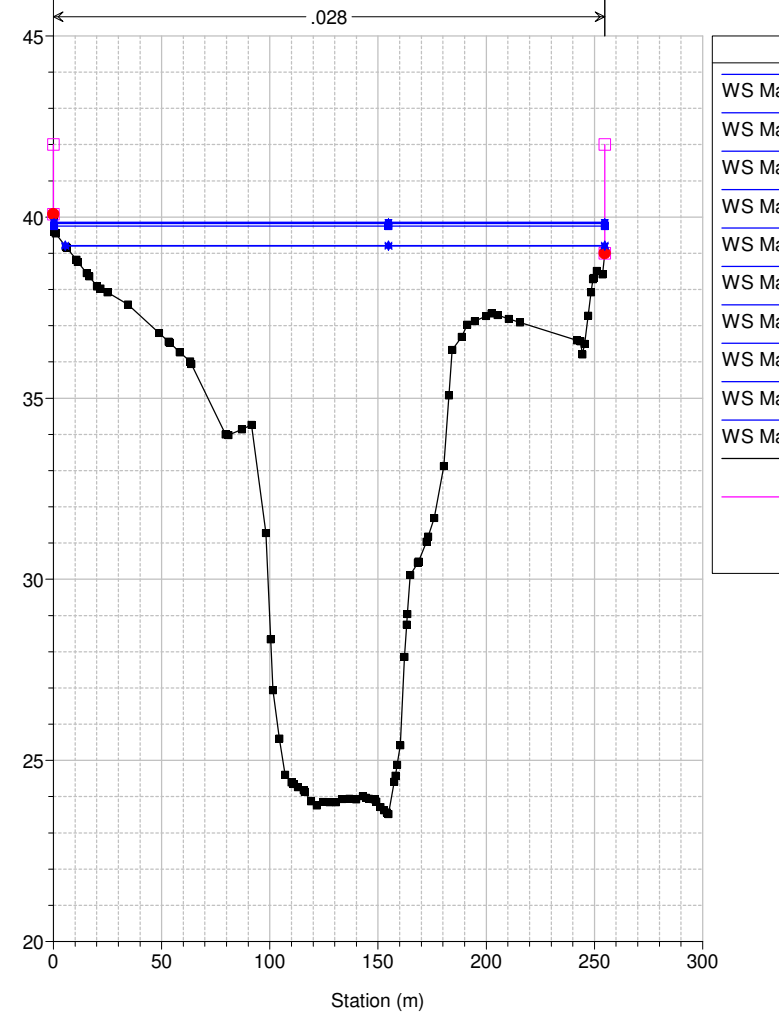

Legend

- WS Max WS - TR030_18_0
- WS Max WS - TR030_24_0
- WS Max WS - TR030_09_0
- WS Max WS - TR030_12_0
- WS Max WS - TR030_36_0
- WS Max WS - TR030_06_0
- WS Max WS - TR030_03_0
- WS Max WS - TR030_00_5
- WS Max WS - TR030_01_0
- WS Max WS - TR030_01_5
- Ground
- Levee
- Bank Sta

**Sezioni fluviali
torrenti Greve-Vingone
stato di progetto
Tr = 200 anni**

Studio Scandicci Torrenti Greve-Vingone
River = Fosso Botteghino Reach = Botteghino RS = 19 SD0013_D

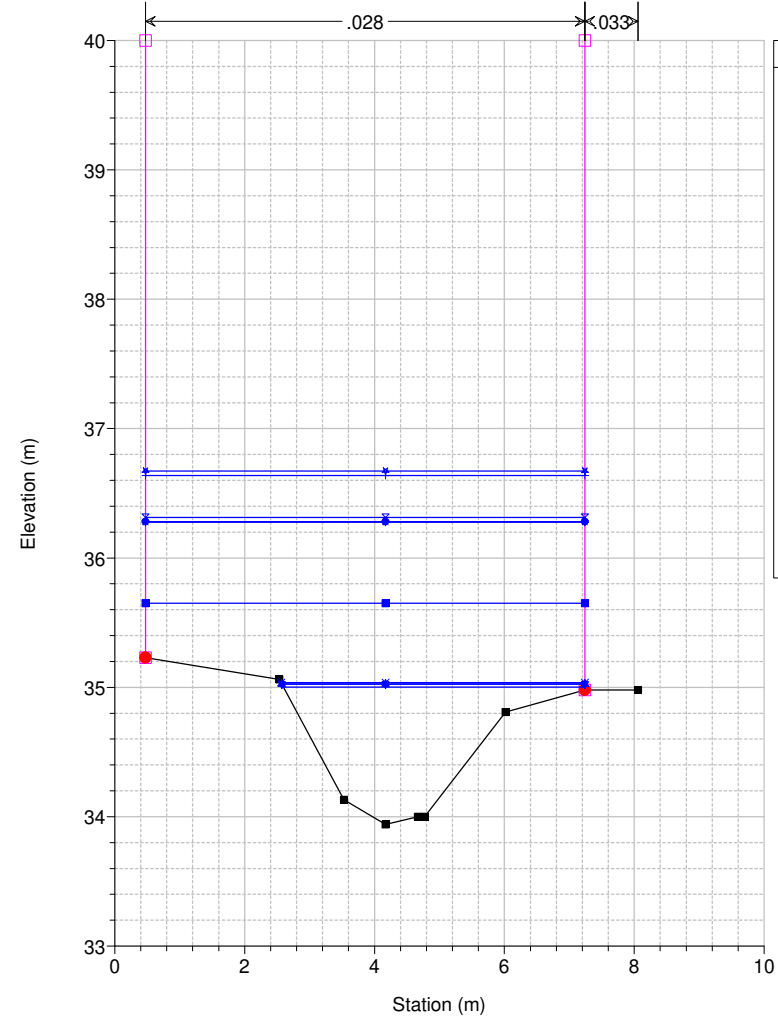

Legend	
WS Max WS - TR200_24_0	+
WS Max WS - TR200_18_0	+
WS Max WS - TR200_12_0	+
WS Max WS - TR200_09_0	+
WS Max WS - TR200_36_0	+
WS Max WS - TR200_06_0	+
WS Max WS - TR200_03_0	+
WS Max WS - TR200_01_5	+
WS Max WS - TR200_01_0	+
WS Max WS - TR200_00_5	+
Ground	■
Levee	□
Bank Sta	●

Studio Scandicci Torrenti Greve-Vingone
River = Fosso Botteghino Reach = Botteghino RS = 18 SD0012_

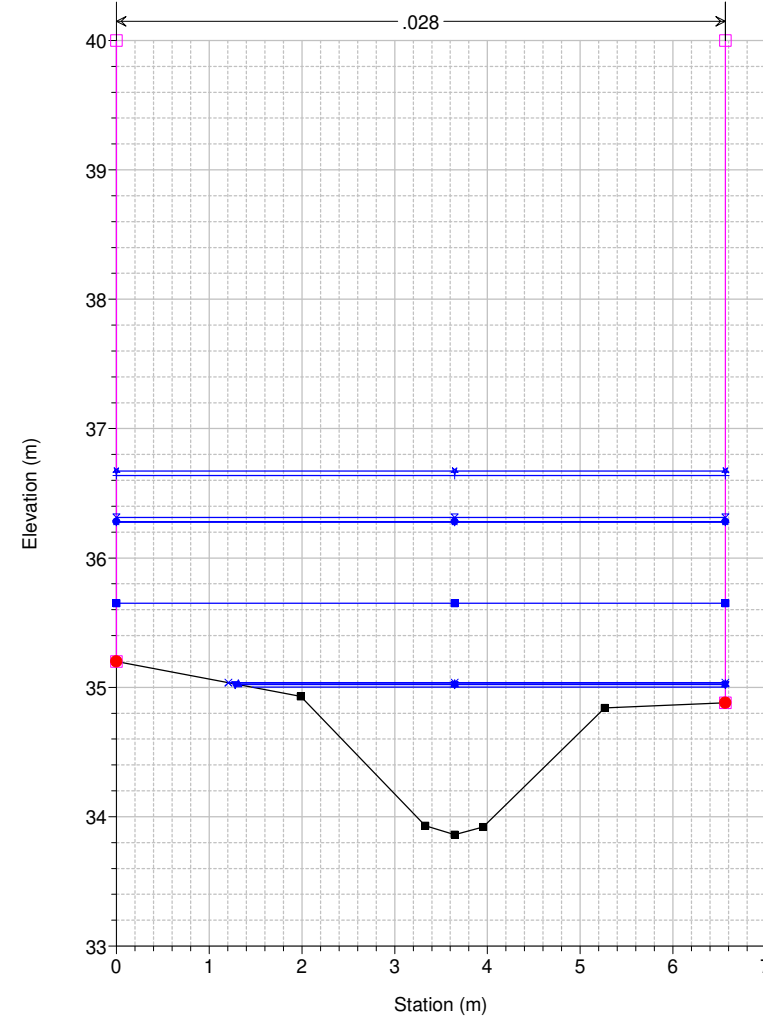

Legend	
WS Max WS - TR200_24_0	+
WS Max WS - TR200_18_0	+
WS Max WS - TR200_12_0	+
WS Max WS - TR200_09_0	+
WS Max WS - TR200_36_0	+
WS Max WS - TR200_06_0	+
WS Max WS - TR200_03_0	+
WS Max WS - TR200_01_5	+
WS Max WS - TR200_01_0	+
WS Max WS - TR200_00_5	+
Ground	■
Levee	□
Bank Sta	●

Studio Scandicci Torrenti Greve-Vingone
River = Fosso Botteghino Reach = Botteghino RS = 17 SD0011_

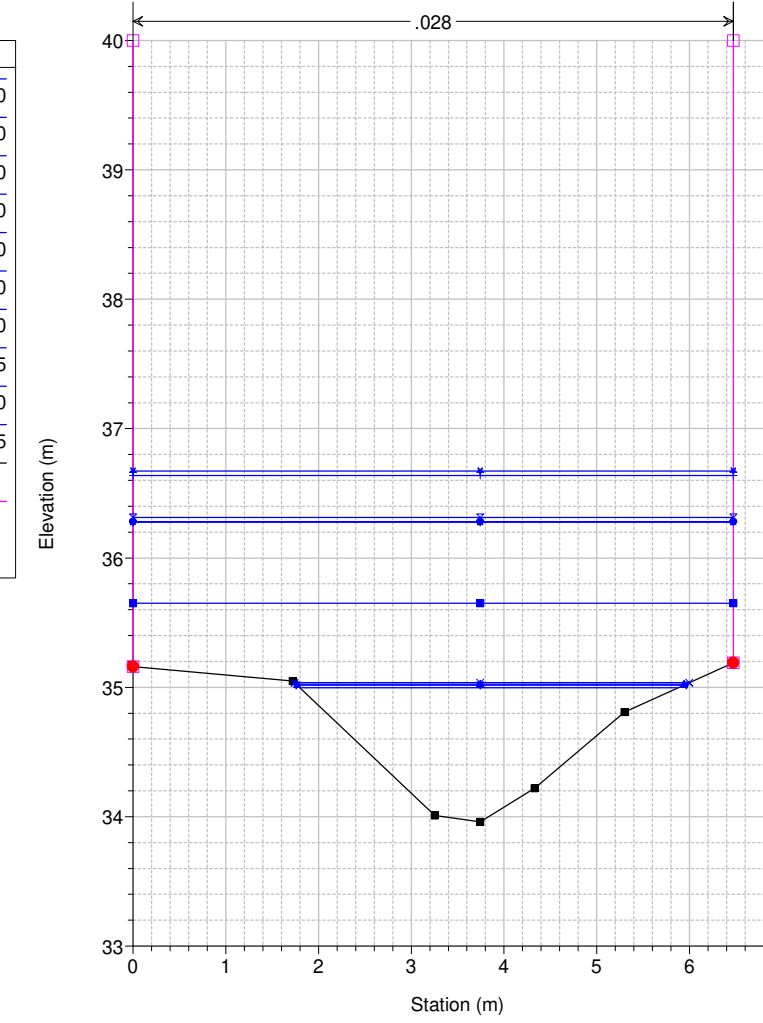

Legend	
WS Max WS - TR200_24_0	+
WS Max WS - TR200_18_0	+
WS Max WS - TR200_12_0	+
WS Max WS - TR200_09_0	+
WS Max WS - TR200_36_0	+
WS Max WS - TR200_06_0	+
WS Max WS - TR200_03_0	+
WS Max WS - TR200_01_5	+
WS Max WS - TR200_01_0	+
WS Max WS - TR200_00_5	+
Ground	■
Levee	□
Bank Sta	●

Studio Scandicci Torrenti Greve-Vingone
River = Fosso Botteghino Reach = Botteghino RS = 16 SD0010_

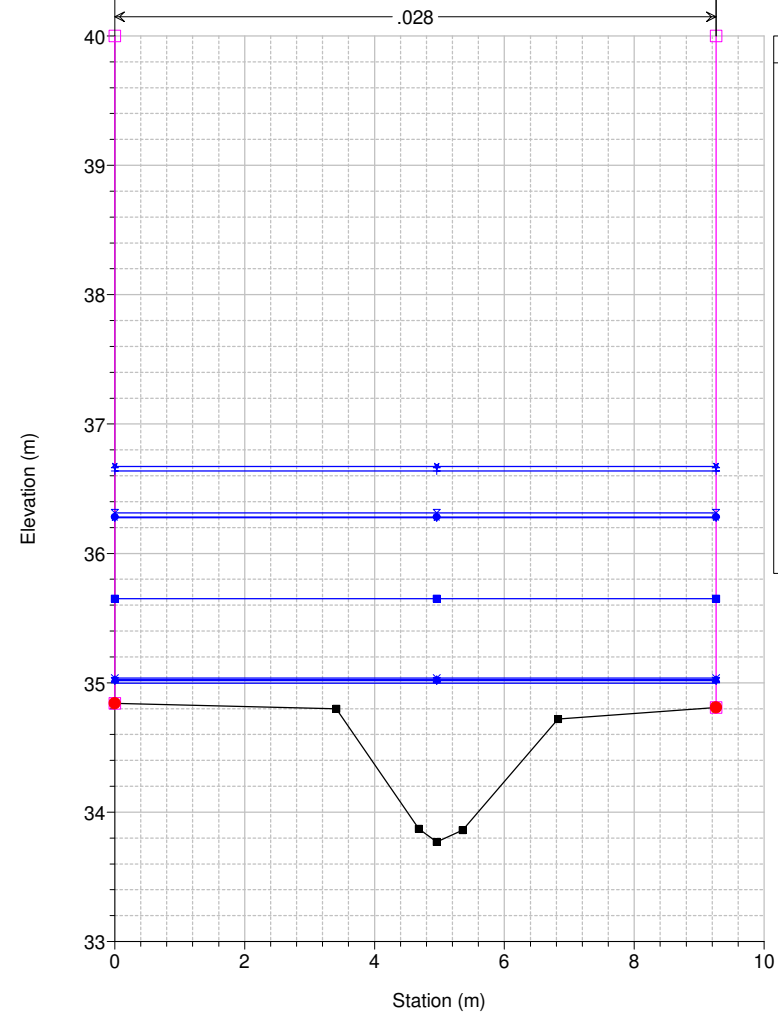

Legend	
WS Max WS - TR200_24_0	+
WS Max WS - TR200_18_0	+
WS Max WS - TR200_12_0	+
WS Max WS - TR200_09_0	+
WS Max WS - TR200_36_0	+
WS Max WS - TR200_06_0	+
WS Max WS - TR200_03_0	+
WS Max WS - TR200_01_5	+
WS Max WS - TR200_01_0	+
WS Max WS - TR200_00_5	+
Ground	■
Levee	□
Bank Sta	●

Studio Scandicci Torrenti Greve-Vingone
River = Fosso Botteghino Reach = Botteghino RS = 15 SD0009_

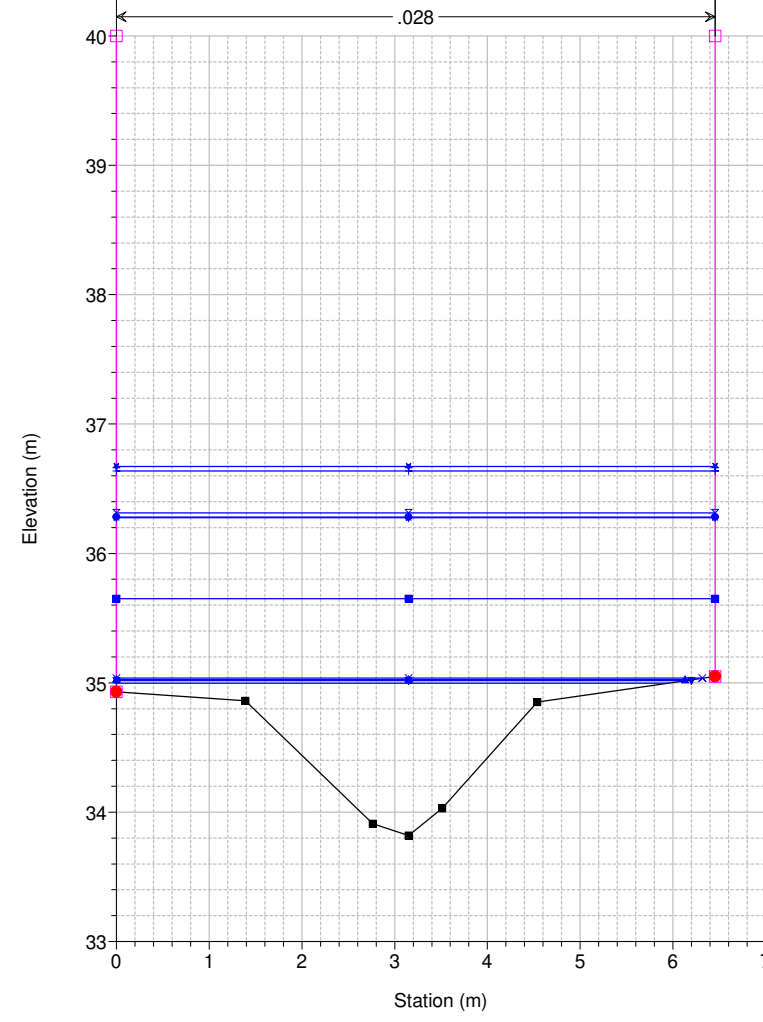

Legend	
WS Max WS - TR200_24_0	+
WS Max WS - TR200_18_0	+
WS Max WS - TR200_12_0	+
WS Max WS - TR200_09_0	+
WS Max WS - TR200_36_0	+
WS Max WS - TR200_06_0	+
WS Max WS - TR200_03_0	+
WS Max WS - TR200_01_5	+
WS Max WS - TR200_01_0	+
WS Max WS - TR200_00_5	+
Ground	■
Levee	□
Bank Sta	●

Studio Scandicci Torrenti Greve-Vingone
River = Fosso Botteghino Reach = Botteghino RS = 14 SD0008_

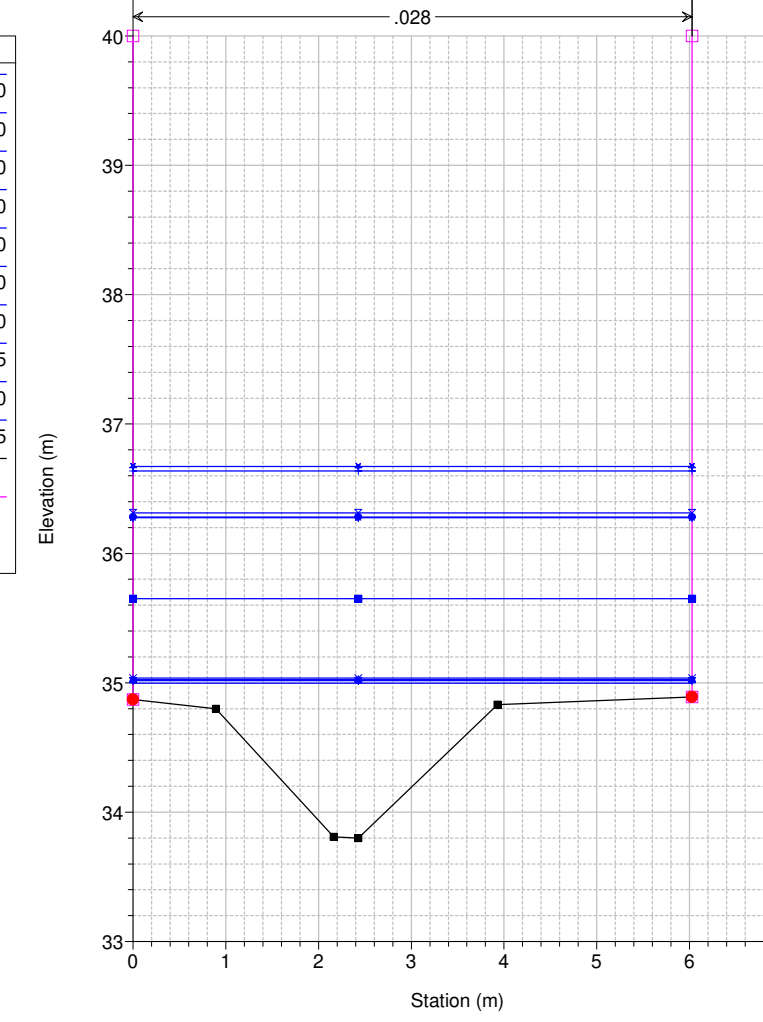

Legend	
WS Max WS - TR200_24_0	+
WS Max WS - TR200_18_0	+
WS Max WS - TR200_12_0	+
WS Max WS - TR200_09_0	+
WS Max WS - TR200_36_0	+
WS Max WS - TR200_06_0	+
WS Max WS - TR200_03_0	+
WS Max WS - TR200_01_5	+
WS Max WS - TR200_01_0	+
WS Max WS - TR200_00_5	+
Ground	■
Levee	□
Bank Sta	●

Studio Scandicci Torrenti Greve-Vingone
River = Fosso Botteghino Reach = Botteghino RS = 13 SD0007_

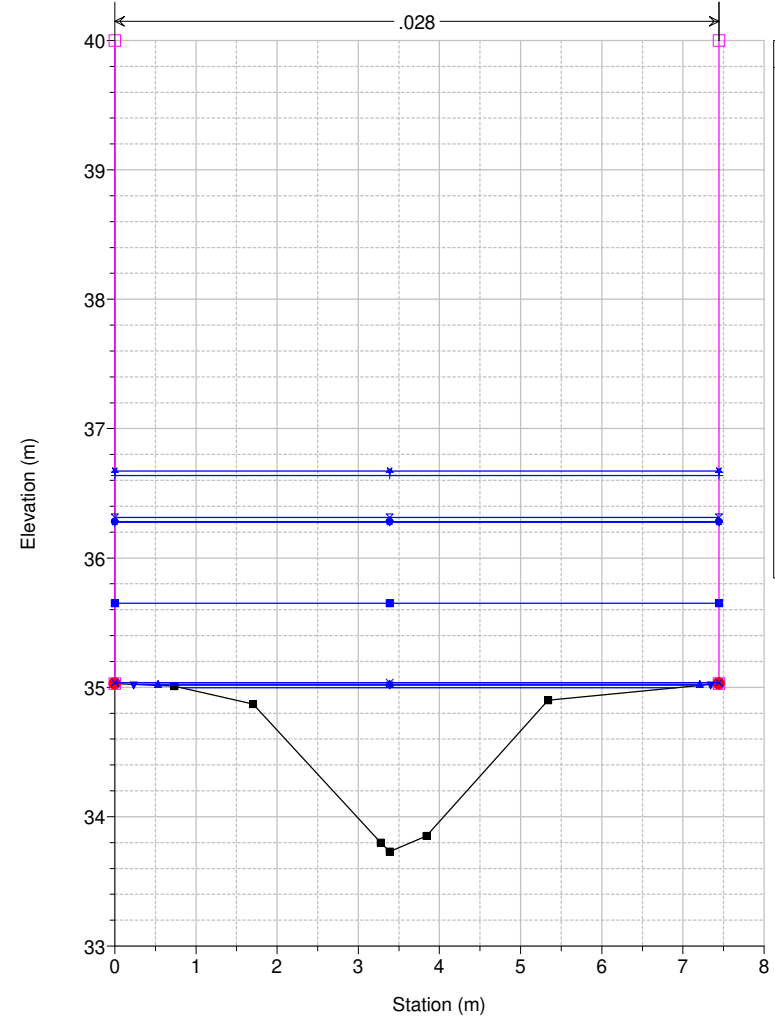

Legend	
WS Max WS - TR200_24_0	▲
WS Max WS - TR200_18_0	▲
WS Max WS - TR200_12_0	▲
WS Max WS - TR200_09_0	▲
WS Max WS - TR200_36_0	▲
WS Max WS - TR200_06_0	▲
WS Max WS - TR200_03_0	▲
WS Max WS - TR200_01_5	▲
WS Max WS - TR200_01_0	▲
WS Max WS - TR200_00_5	▲
Ground	■
Levee	□
Bank Sta	●

Studio Scandicci Torrenti Greve-Vingone
River = Fosso Botteghino Reach = Botteghino RS = 12 SD0006_A

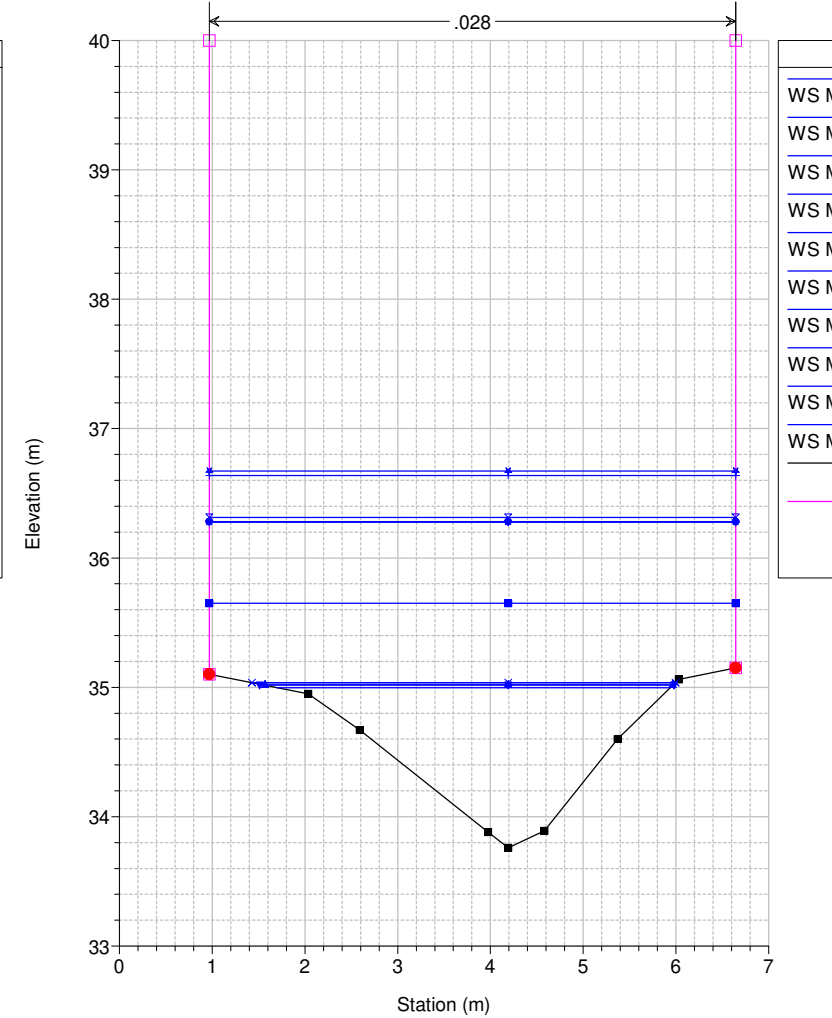

Legend	
WS Max WS - TR200_24_0	▲
WS Max WS - TR200_18_0	▲
WS Max WS - TR200_12_0	▲
WS Max WS - TR200_09_0	▲
WS Max WS - TR200_36_0	▲
WS Max WS - TR200_06_0	▲
WS Max WS - TR200_03_0	▲
WS Max WS - TR200_01_5	▲
WS Max WS - TR200_01_0	▲
WS Max WS - TR200_00_5	▲
Ground	■
Levee	□
Bank Sta	●

Studio Scandicci Torrenti Greve-Vingone
River = Fosso Botteghino Reach = Botteghino RS = 11 SD0006_B

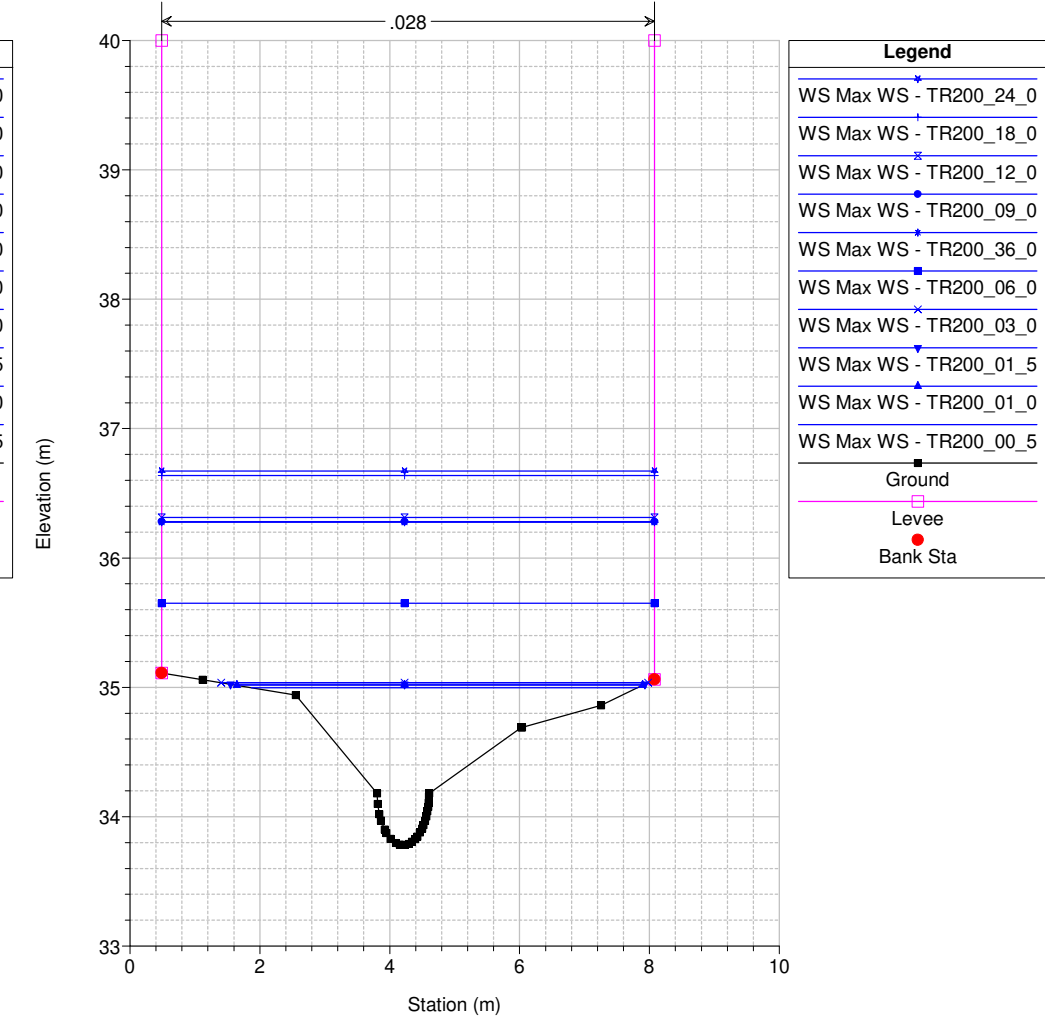

Legend	
WS Max WS - TR200_24_0	▲
WS Max WS - TR200_18_0	▲
WS Max WS - TR200_12_0	▲
WS Max WS - TR200_09_0	▲
WS Max WS - TR200_36_0	▲
WS Max WS - TR200_06_0	▲
WS Max WS - TR200_03_0	▲
WS Max WS - TR200_01_5	▲
WS Max WS - TR200_01_0	▲
WS Max WS - TR200_00_5	▲
Ground	■
Levee	□
Bank Sta	●

Studio Scandicci Torrenti Greve-Vingone
River = Fosso Botteghino Reach = Botteghino RS = 10.5 BR

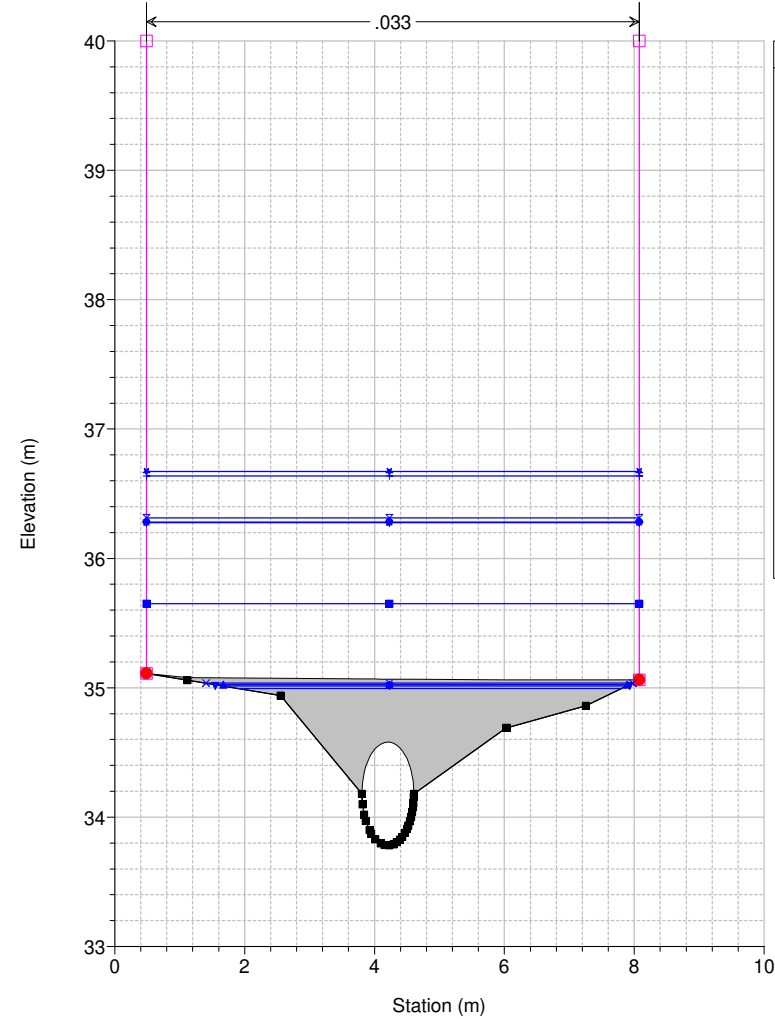

Legend	
WS Max WS - TR200_24_0	▲
WS Max WS - TR200_18_0	▲
WS Max WS - TR200_12_0	▲
WS Max WS - TR200_09_0	▲
WS Max WS - TR200_36_0	▲
WS Max WS - TR200_06_0	▲
WS Max WS - TR200_03_0	▲
WS Max WS - TR200_01_5	▲
WS Max WS - TR200_01_0	▲
WS Max WS - TR200_00_5	▲
Ground	■
Levee	□
Bank Sta	●

Studio Scandicci Torrenti Greve-Vingone
River = Fosso Botteghino Reach = Botteghino RS = 10.5 BR

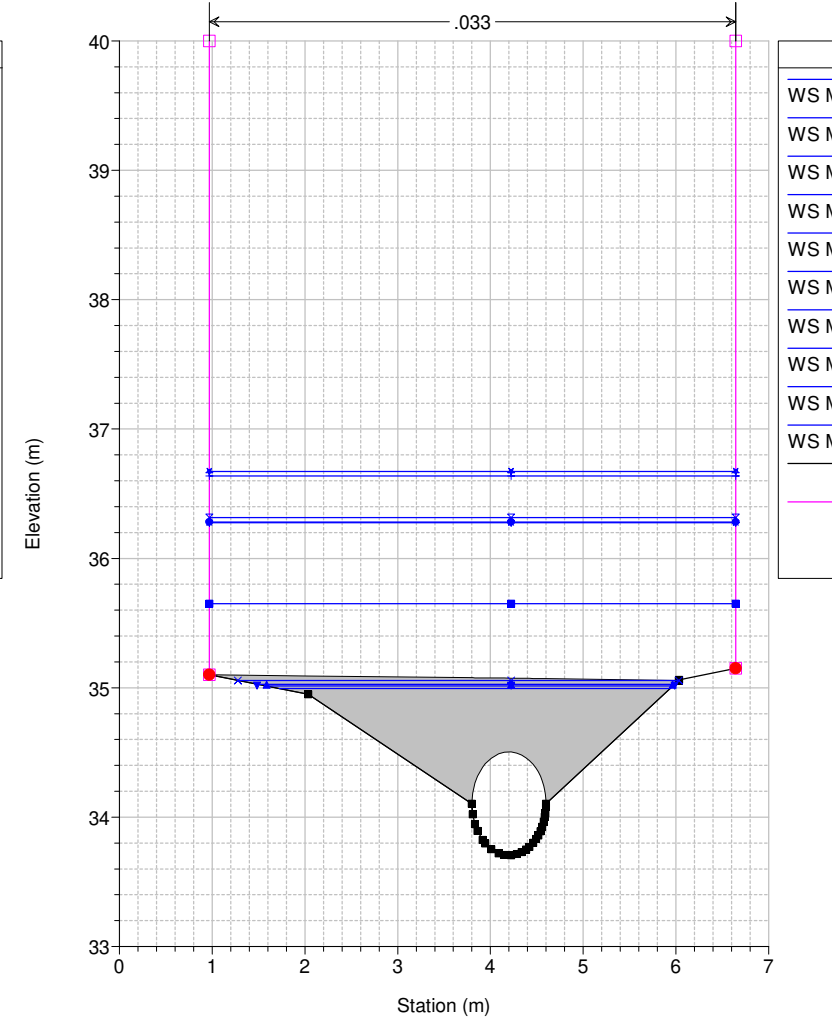

Legend	
WS Max WS - TR200_24_0	▲
WS Max WS - TR200_18_0	▲
WS Max WS - TR200_12_0	▲
WS Max WS - TR200_09_0	▲
WS Max WS - TR200_36_0	▲
WS Max WS - TR200_06_0	▲
WS Max WS - TR200_03_0	▲
WS Max WS - TR200_01_5	▲
WS Max WS - TR200_01_0	▲
WS Max WS - TR200_00_5	▲
Ground	■
Levee	□
Bank Sta	●

Studio Scandicci Torrenti Greve-Vingone
River = Fosso Botteghino Reach = Botteghino RS = 10 SD0006_C

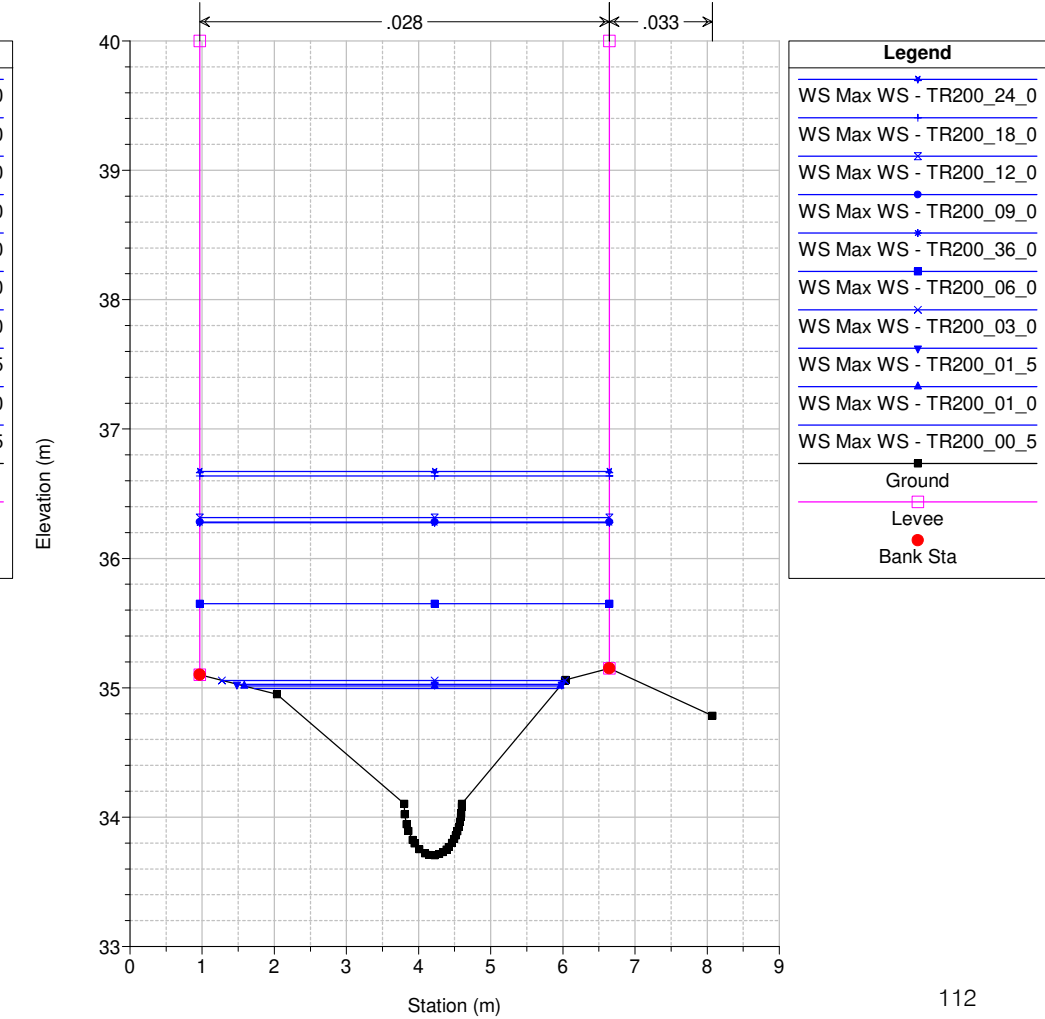

Legend	
WS Max WS - TR200_24_0	▲
WS Max WS - TR200_18_0	▲
WS Max WS - TR200_12_0	▲
WS Max WS - TR200_09_0	▲
WS Max WS - TR200_36_0	▲
WS Max WS - TR200_06_0	▲
WS Max WS - TR200_03_0	▲
WS Max WS - TR200_01_5	▲
WS Max WS - TR200_01_0	▲
WS Max WS - TR200_00_5	▲
Ground	■
Levee	□
Bank Sta	●

Studio Scandicci Torrenti Greve-Vingone
River = Fosso Botteghino Reach = Botteghino RS = 9 SD0006_D

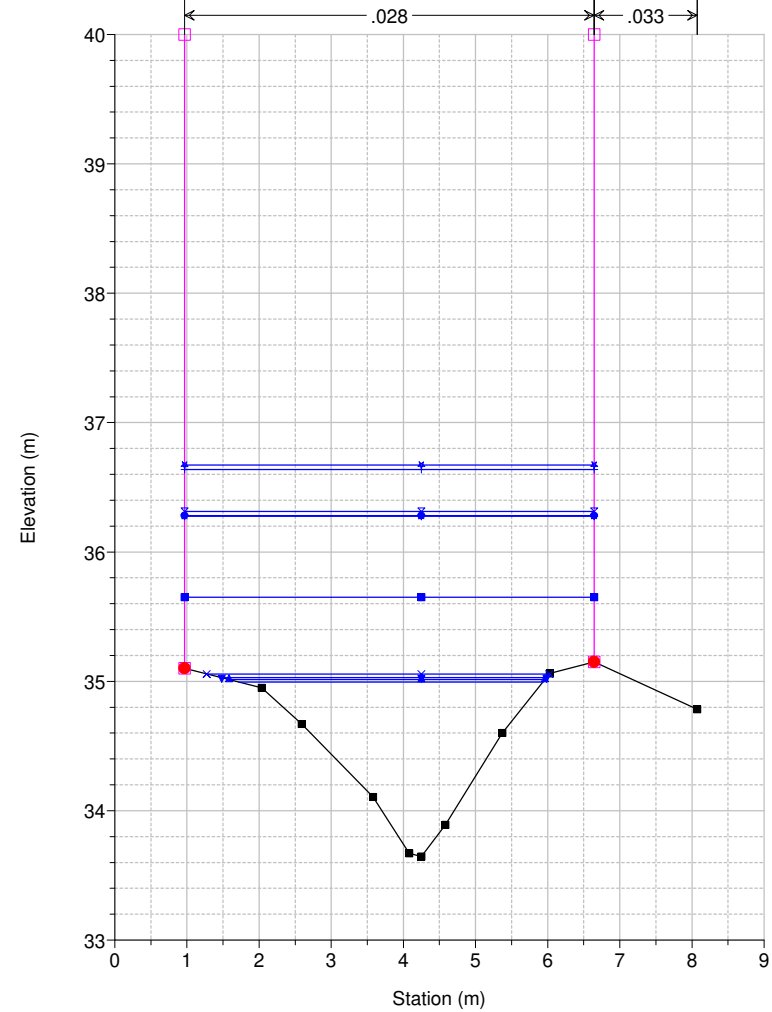

Legend	
WS Max WS - TR200_24_0	✕
WS Max WS - TR200_18_0	+
WS Max WS - TR200_12_0	✕
WS Max WS - TR200_09_0	•
WS Max WS - TR200_36_0	•
WS Max WS - TR200_06_0	•
WS Max WS - TR200_03_0	✕
WS Max WS - TR200_01_5	▼
WS Max WS - TR200_01_0	▲
WS Max WS - TR200_00_5	■
Ground	■
Levee	□
Bank Sta	•

Studio Scandicci Torrenti Greve-Vingone
River = Fosso Botteghino Reach = Botteghino RS = 8 SD0005_

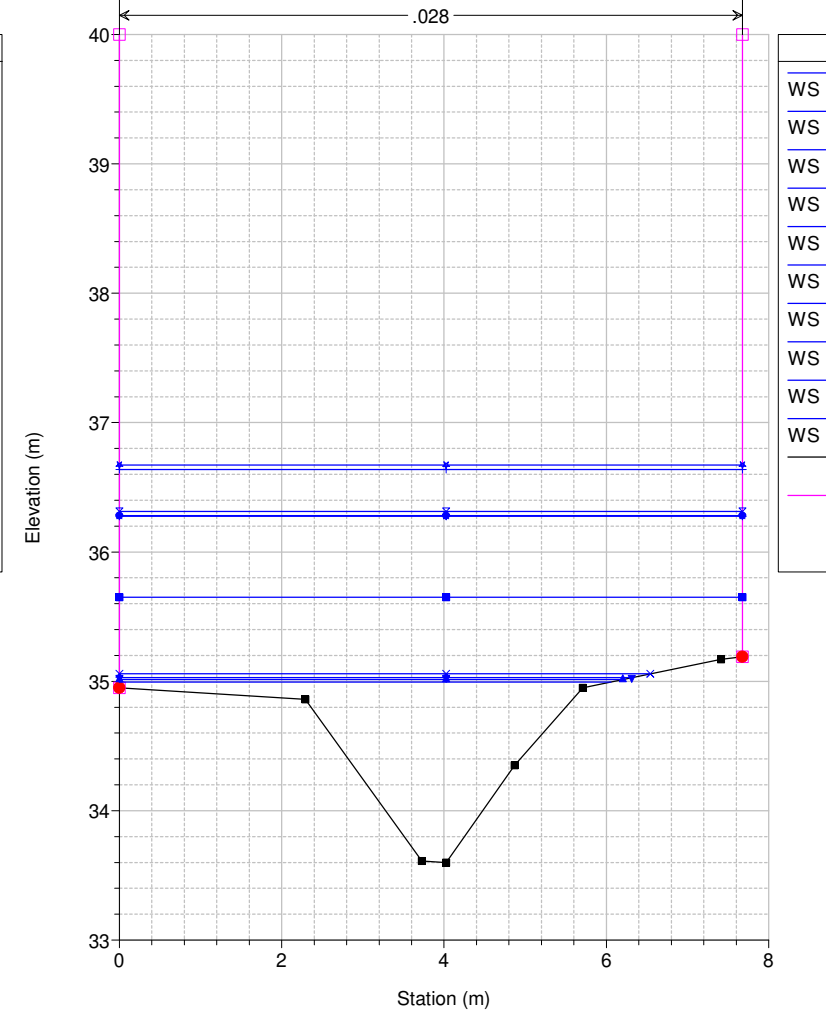

Legend	
WS Max WS - TR200_24_0	✕
WS Max WS - TR200_18_0	+
WS Max WS - TR200_12_0	✕
WS Max WS - TR200_09_0	•
WS Max WS - TR200_36_0	•
WS Max WS - TR200_06_0	•
WS Max WS - TR200_03_0	✕
WS Max WS - TR200_01_5	▼
WS Max WS - TR200_01_0	▲
WS Max WS - TR200_00_5	■
Ground	■
Levee	□
Bank Sta	•

Studio Scandicci Torrenti Greve-Vingone
River = Fosso Botteghino Reach = Botteghino RS = 7 SD0004_

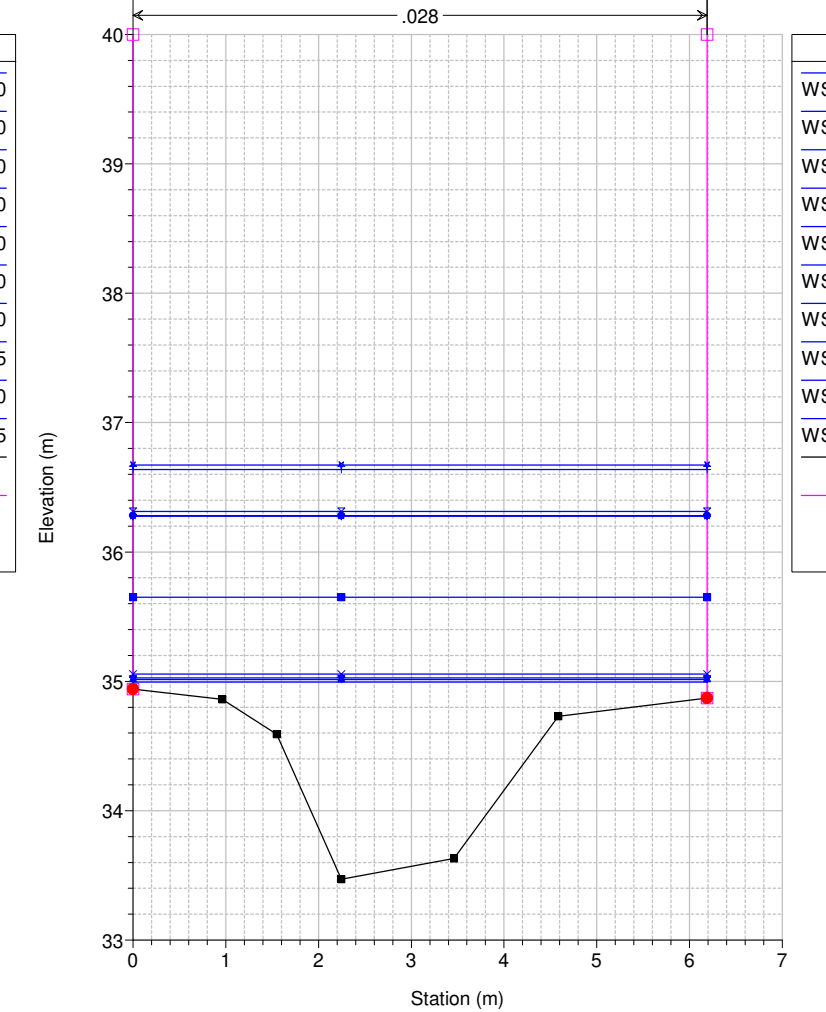

Legend	
WS Max WS - TR200_24_0	✕
WS Max WS - TR200_18_0	+
WS Max WS - TR200_12_0	✕
WS Max WS - TR200_09_0	•
WS Max WS - TR200_36_0	•
WS Max WS - TR200_06_0	•
WS Max WS - TR200_03_0	✕
WS Max WS - TR200_01_5	▼
WS Max WS - TR200_01_0	▲
WS Max WS - TR200_00_5	■
Ground	■
Levee	□
Bank Sta	•

Studio Scandicci Torrenti Greve-Vingone
River = Fosso Botteghino Reach = Botteghino RS = 6 SD0003_

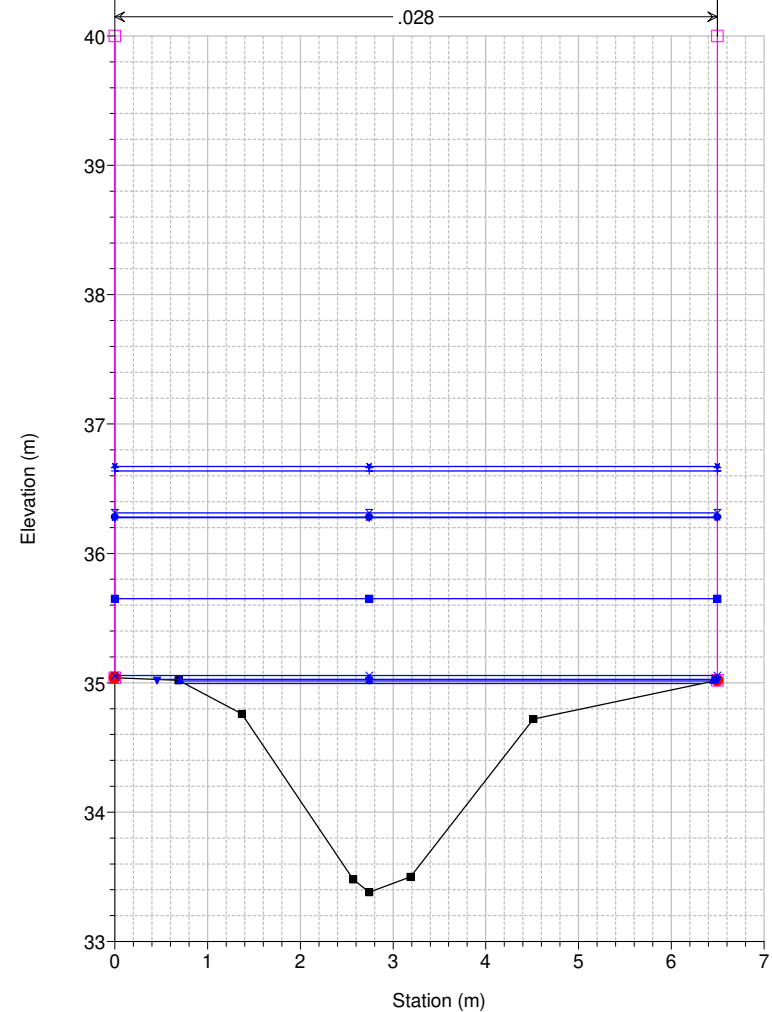

Legend	
WS Max WS - TR200_24_0	✕
WS Max WS - TR200_18_0	+
WS Max WS - TR200_12_0	✕
WS Max WS - TR200_09_0	•
WS Max WS - TR200_36_0	•
WS Max WS - TR200_06_0	•
WS Max WS - TR200_03_0	✕
WS Max WS - TR200_01_5	▼
WS Max WS - TR200_01_0	▲
WS Max WS - TR200_00_5	■
Ground	■
Levee	□
Bank Sta	•

Studio Scandicci Torrenti Greve-Vingone
River = Fosso Botteghino Reach = Botteghino RS = 5 SD0002_

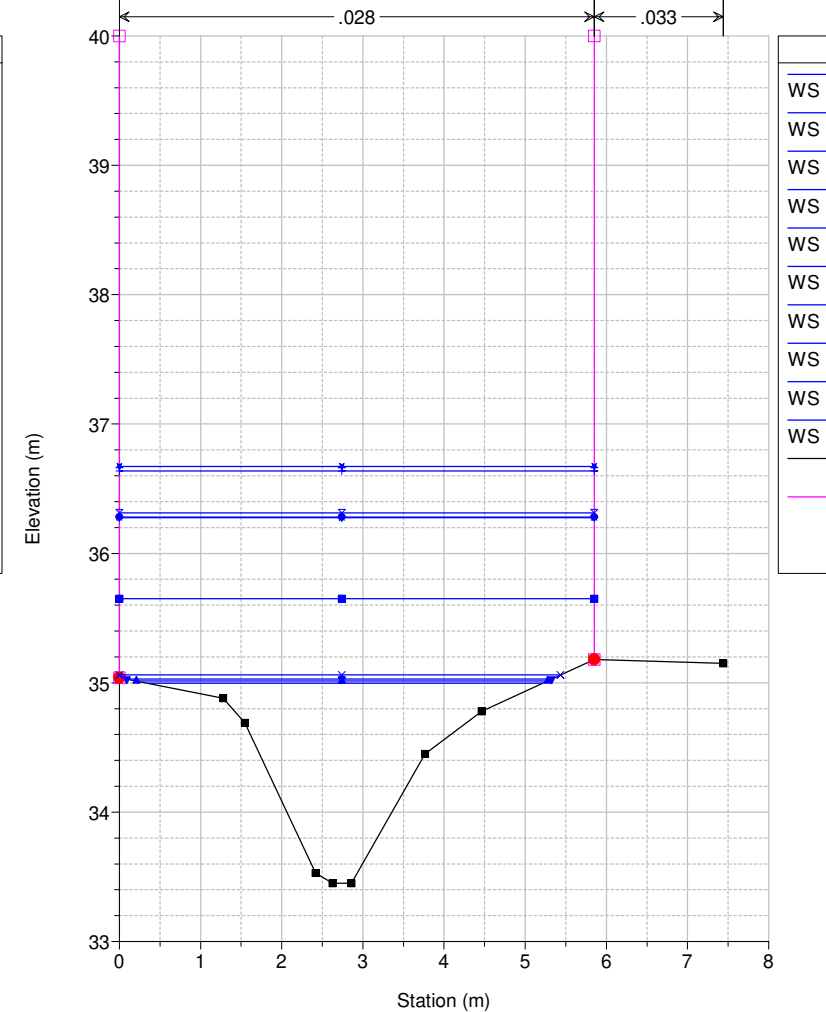

Legend	
WS Max WS - TR200_24_0	✕
WS Max WS - TR200_18_0	+
WS Max WS - TR200_12_0	✕
WS Max WS - TR200_09_0	•
WS Max WS - TR200_36_0	•
WS Max WS - TR200_06_0	•
WS Max WS - TR200_03_0	✕
WS Max WS - TR200_01_5	▼
WS Max WS - TR200_01_0	▲
WS Max WS - TR200_00_5	■
Ground	■
Levee	□
Bank Sta	•

Studio Scandicci Torrenti Greve-Vingone
River = Fosso Botteghino Reach = Botteghino RS = 4 SD0001_A

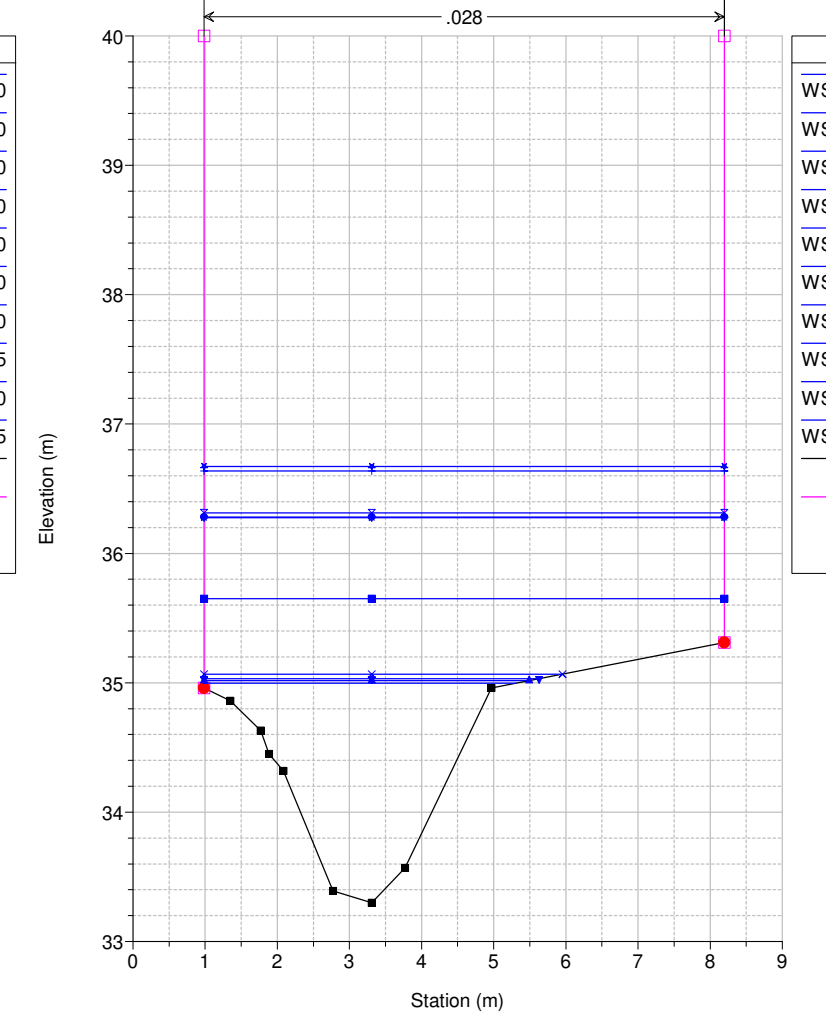

Legend	
WS Max WS - TR200_24_0	✕
WS Max WS - TR200_18_0	+
WS Max WS - TR200_12_0	✕
WS Max WS - TR200_09_0	•
WS Max WS - TR200_36_0	•
WS Max WS - TR200_06_0	•
WS Max WS - TR200_03_0	✕
WS Max WS - TR200_01_5	▼
WS Max WS - TR200_01_0	▲
WS Max WS - TR200_00_5	■
Ground	■
Levee	□
Bank Sta	•

Studio Scandicci Torrenti Greve-Vingone

River = Fosso Botteghino Reach = Botteghino RS = 3 SD0001_B

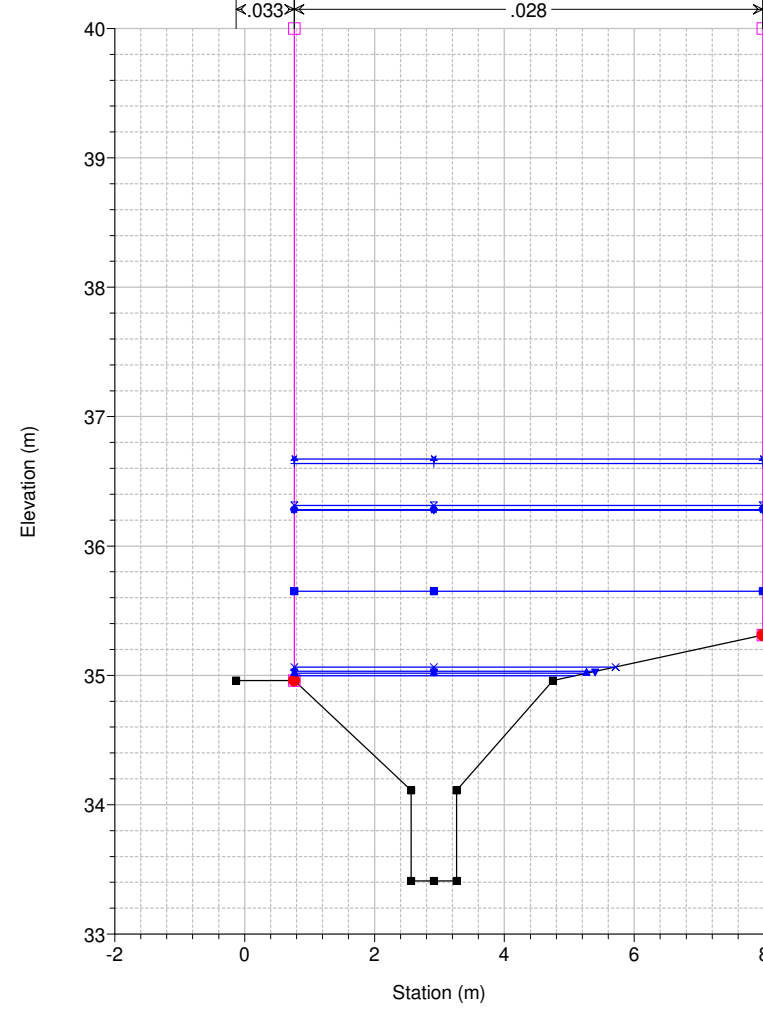

Legend	
WS Max WS - TR200_24_0	✕
WS Max WS - TR200_18_0	+
WS Max WS - TR200_12_0	✕
WS Max WS - TR200_09_0	•
WS Max WS - TR200_09_0	•
WS Max WS - TR200_36_0	•
WS Max WS - TR200_06_0	•
WS Max WS - TR200_03_0	✕
WS Max WS - TR200_01_5	•
WS Max WS - TR200_01_0	•
WS Max WS - TR200_00_5	•
Ground	■
Levee	□
Bank Sta	●

Studio Scandicci Torrenti Greve-Vingone

River = Fosso Botteghino Reach = Botteghino RS = 2.5 IS

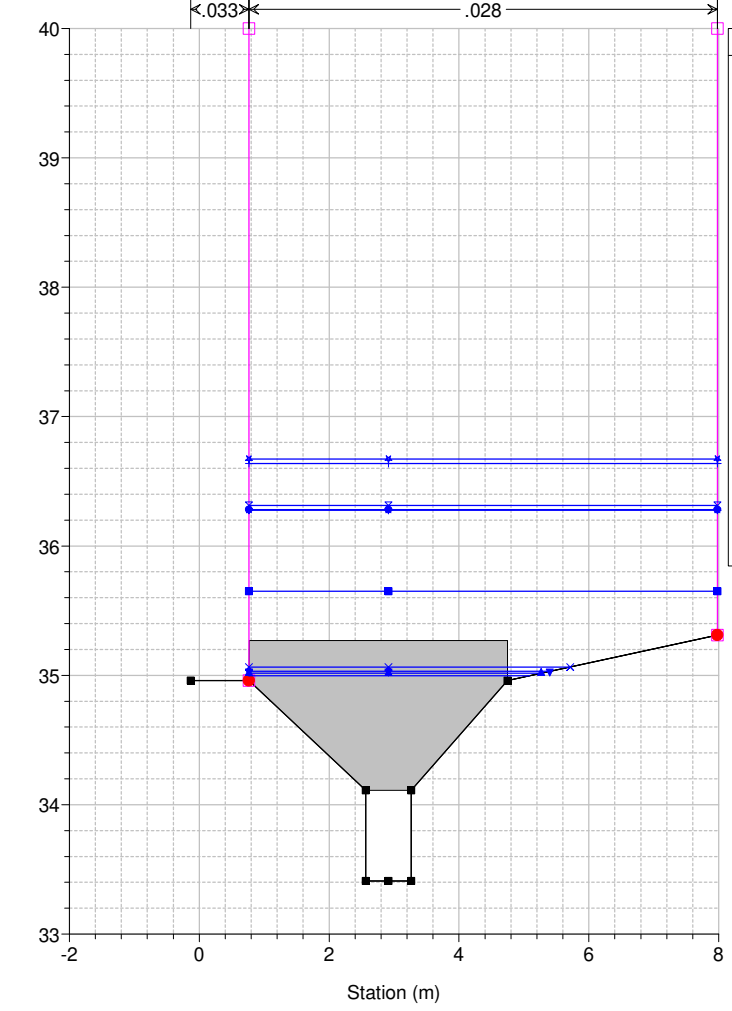

Legend	
WS Max WS - TR200_24_0	✕
WS Max WS - TR200_18_0	+
WS Max WS - TR200_12_0	✕
WS Max WS - TR200_09_0	•
WS Max WS - TR200_09_0	•
WS Max WS - TR200_36_0	•
WS Max WS - TR200_06_0	•
WS Max WS - TR200_03_0	✕
WS Max WS - TR200_01_5	•
WS Max WS - TR200_01_0	•
WS Max WS - TR200_00_5	•
Ground	■
Levee	□
Bank Sta	●

Studio Scandicci Torrenti Greve-Vingone

River = Fosso Botteghino Reach = Botteghino RS = 2 SD0001_C

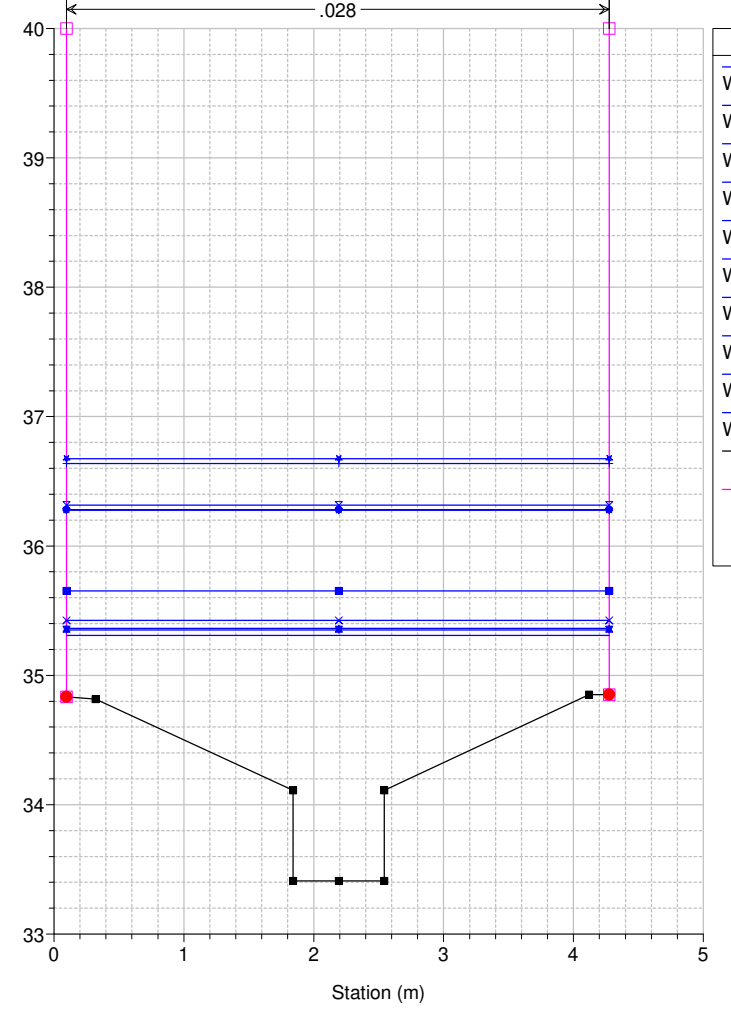

Legend	
WS Max WS - TR200_24_0	✕
WS Max WS - TR200_18_0	+
WS Max WS - TR200_12_0	✕
WS Max WS - TR200_09_0	•
WS Max WS - TR200_09_0	•
WS Max WS - TR200_36_0	•
WS Max WS - TR200_06_0	•
WS Max WS - TR200_03_0	✕
WS Max WS - TR200_01_5	•
WS Max WS - TR200_01_0	•
WS Max WS - TR200_00_5	•
Ground	■
Levee	□
Bank Sta	●

Studio Scandicci Torrenti Greve-Vingone

River = Fosso Botteghino Reach = Botteghino RS = 1 SD0001_D

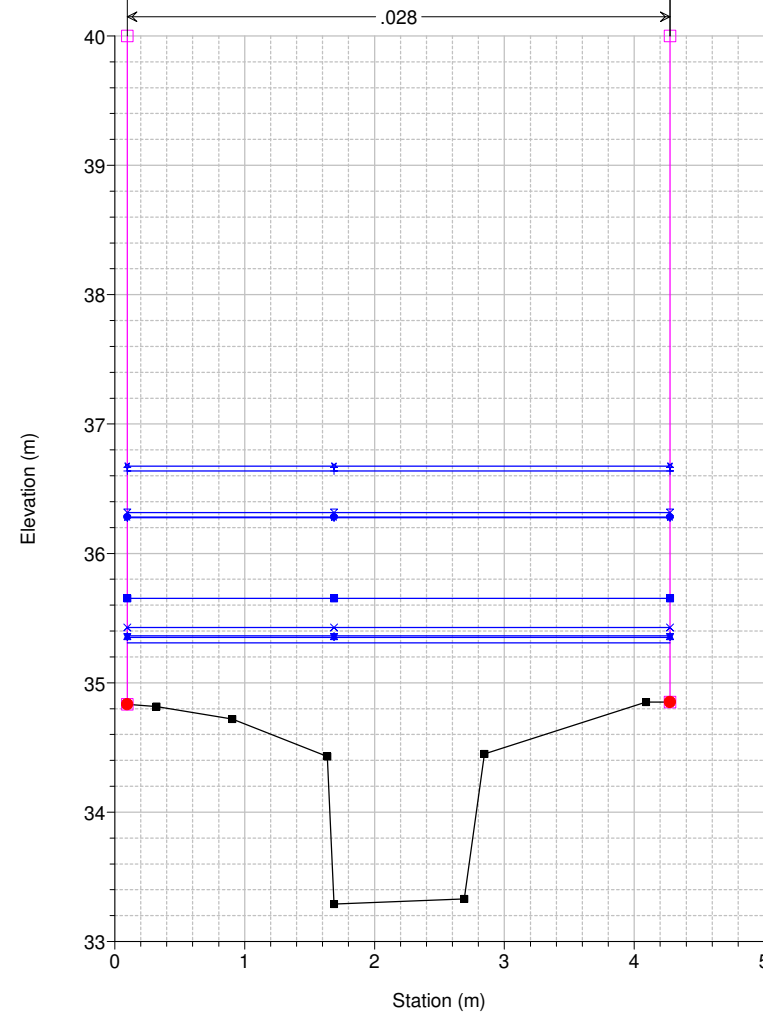

Legend	
WS Max WS - TR200_24_0	✕
WS Max WS - TR200_18_0	+
WS Max WS - TR200_12_0	✕
WS Max WS - TR200_09_0	•
WS Max WS - TR200_09_0	•
WS Max WS - TR200_36_0	•
WS Max WS - TR200_06_0	•
WS Max WS - TR200_03_0	✕
WS Max WS - TR200_01_5	•
WS Max WS - TR200_01_0	•
WS Max WS - TR200_00_5	•
Ground	■
Levee	□
Bank Sta	●

Studio Scandicci Torrenti Greve-Vingone
River = Fosso Dogaia Reach = Dogaia_02 RS = 48 DO1013_D

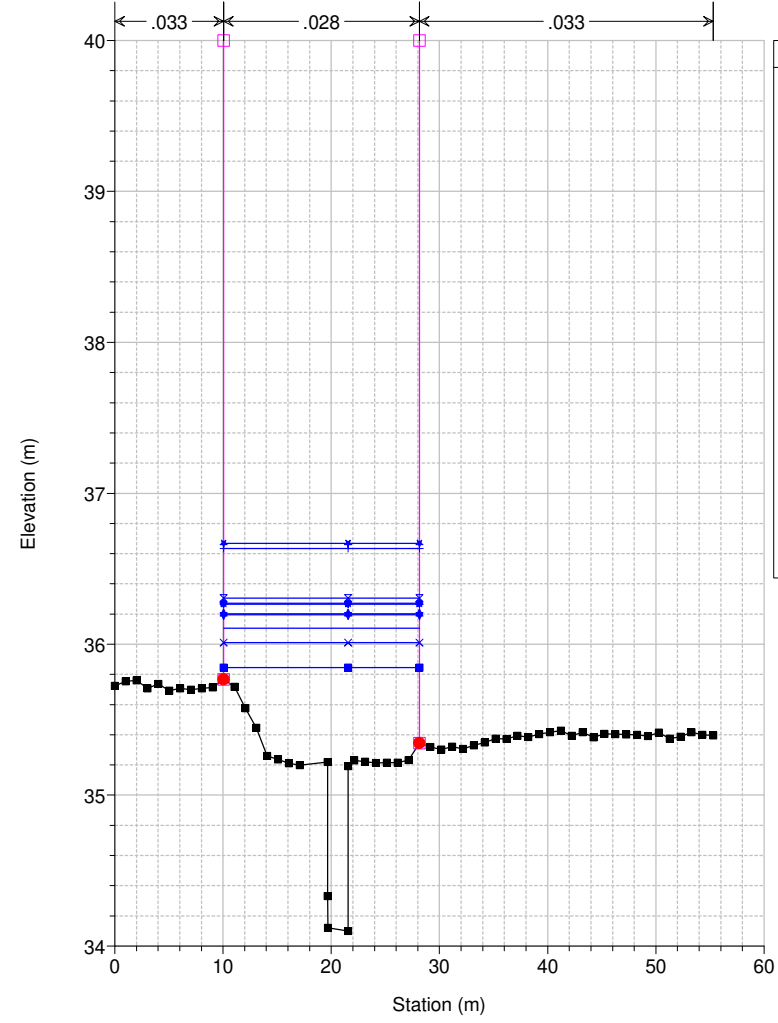

Legend	
WS Max WS - TR200_24_0	▲
WS Max WS - TR200_18_0	+
WS Max WS - TR200_12_0	✕
WS Max WS - TR200_09_0	●
WS Max WS - TR200_36_0	▲
WS Max WS - TR200_01_0	▼
WS Max WS - TR200_01_5	▼
WS Max WS - TR200_00_5	✕
WS Max WS - TR200_03_0	✕
WS Max WS - TR200_06_0	■
Ground	■
Levee	□
Bank Sta	●

Studio Scandicci Torrenti Greve-Vingone
River = Fosso Dogaia Reach = Dogaia_02 RS = 47 DO1014_A

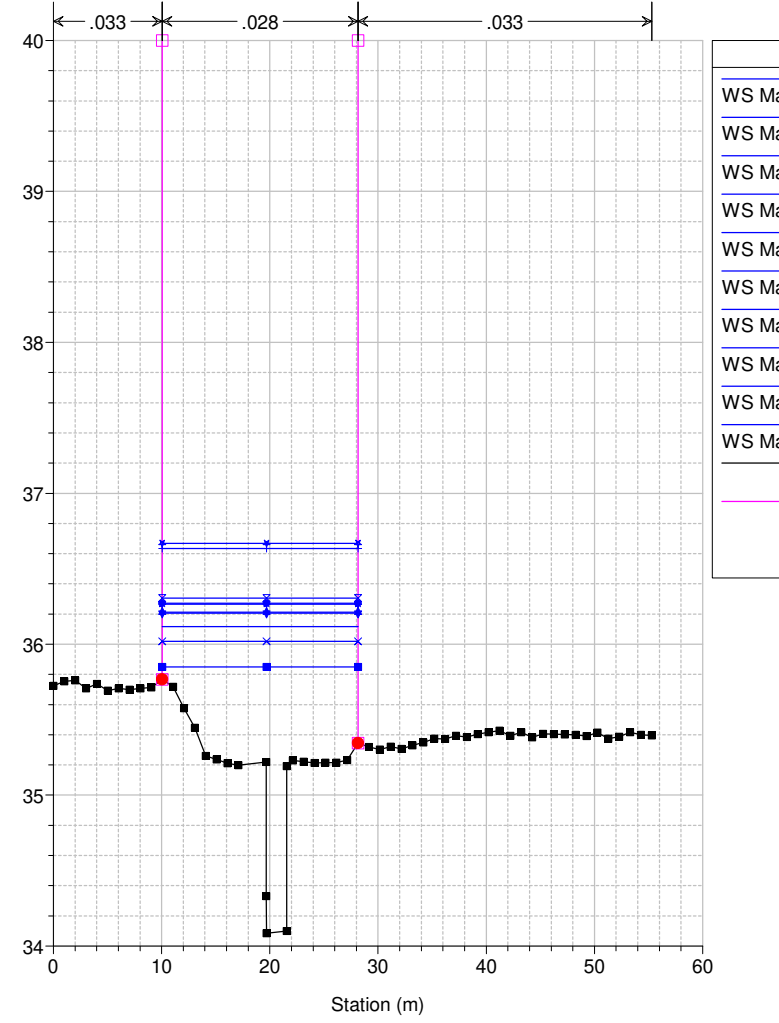

Legend	
WS Max WS - TR200_24_0	▲
WS Max WS - TR200_18_0	+
WS Max WS - TR200_12_0	✕
WS Max WS - TR200_09_0	●
WS Max WS - TR200_36_0	▲
WS Max WS - TR200_01_0	▼
WS Max WS - TR200_01_5	▼
WS Max WS - TR200_00_5	✕
WS Max WS - TR200_03_0	✕
WS Max WS - TR200_06_0	■
Ground	■
Levee	□
Bank Sta	●

Studio Scandicci Torrenti Greve-Vingone
River = Fosso Dogaia Reach = Dogaia_02 RS = 46 DO1014_b

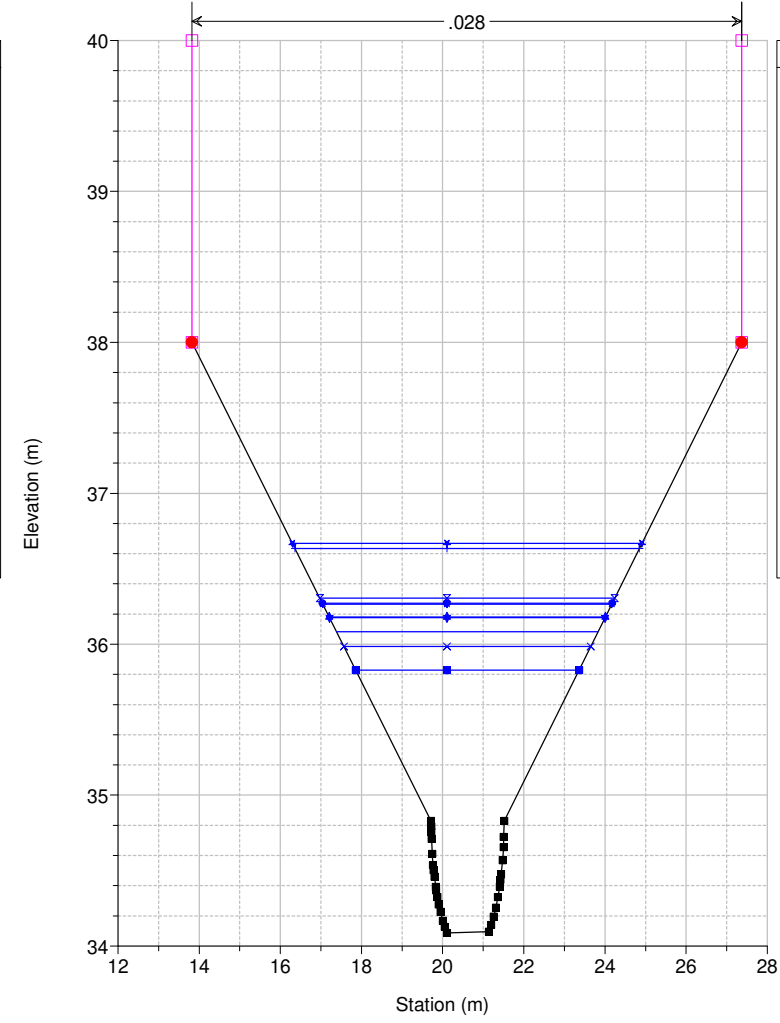

Legend	
WS Max WS - TR200_24_0	▲
WS Max WS - TR200_18_0	+
WS Max WS - TR200_12_0	✕
WS Max WS - TR200_09_0	●
WS Max WS - TR200_36_0	▲
WS Max WS - TR200_01_0	▼
WS Max WS - TR200_01_5	▼
WS Max WS - TR200_00_5	✕
WS Max WS - TR200_03_0	✕
WS Max WS - TR200_06_0	■
Ground	■
Levee	□
Bank Sta	●

Studio Scandicci Torrenti Greve-Vingone
River = Fosso Dogaia Reach = Dogaia_02 RS = 45.5 BR

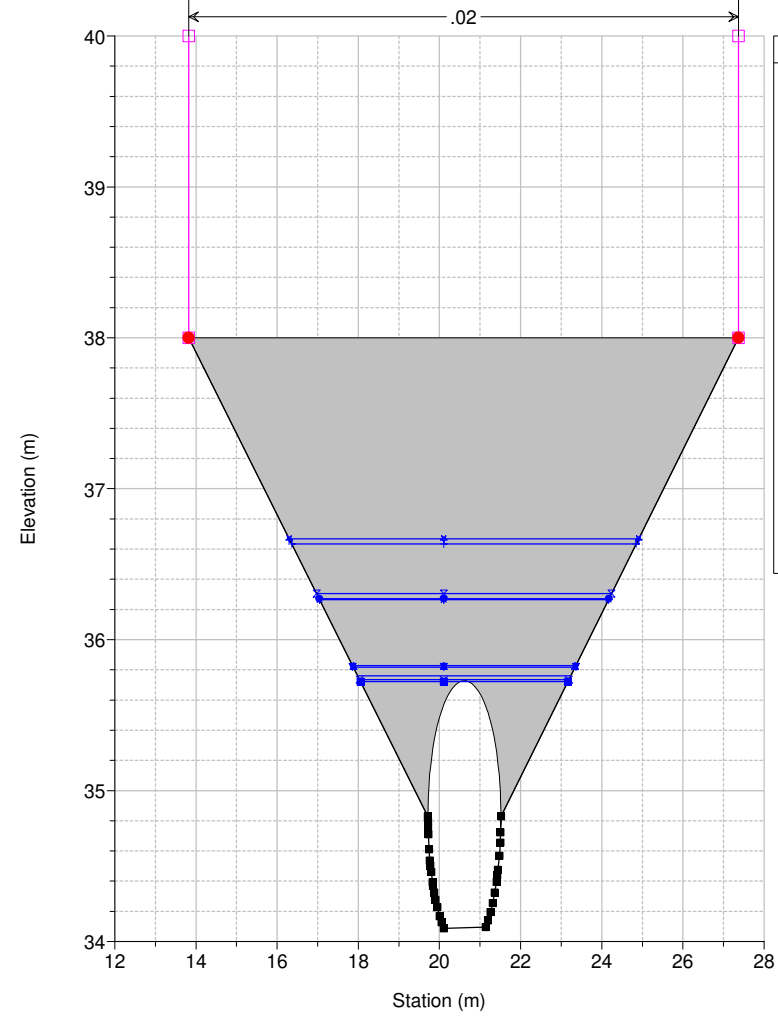

Legend	
WS Max WS - TR200_24_0	▲
WS Max WS - TR200_18_0	+
WS Max WS - TR200_12_0	✕
WS Max WS - TR200_09_0	●
WS Max WS - TR200_36_0	▲
WS Max WS - TR200_01_5	▼
WS Max WS - TR200_01_0	▼
WS Max WS - TR200_00_5	✕
WS Max WS - TR200_03_0	✕
WS Max WS - TR200_06_0	■
Ground	■
Levee	□
Bank Sta	●

Studio Scandicci Torrenti Greve-Vingone
River = Fosso Dogaia Reach = Dogaia_02 RS = 45.5 BR

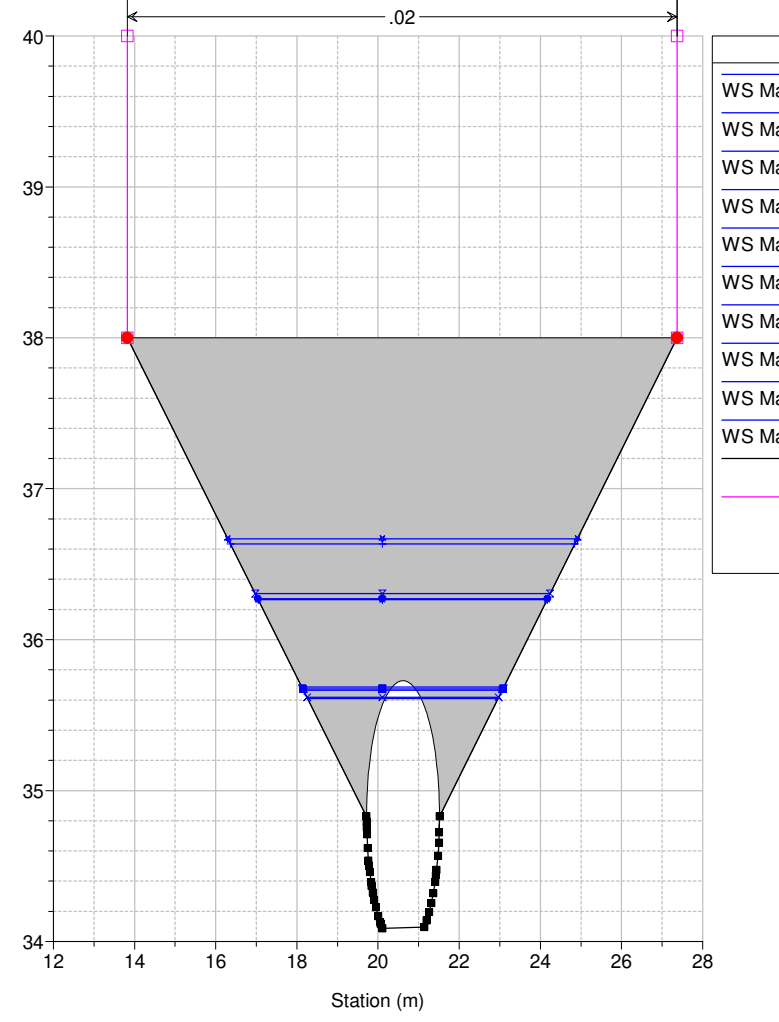

Legend	
WS Max WS - TR200_24_0	▲
WS Max WS - TR200_18_0	+
WS Max WS - TR200_12_0	✕
WS Max WS - TR200_09_0	●
WS Max WS - TR200_36_0	▲
WS Max WS - TR200_01_5	▼
WS Max WS - TR200_01_0	▼
WS Max WS - TR200_06_0	■
WS Max WS - TR200_03_0	✕
WS Max WS - TR200_00_5	✕
Ground	■
Levee	□
Bank Sta	●

Studio Scandicci Torrenti Greve-Vingone
River = Fosso Dogaia Reach = Dogaia_02 RS = 45 DO1014_C

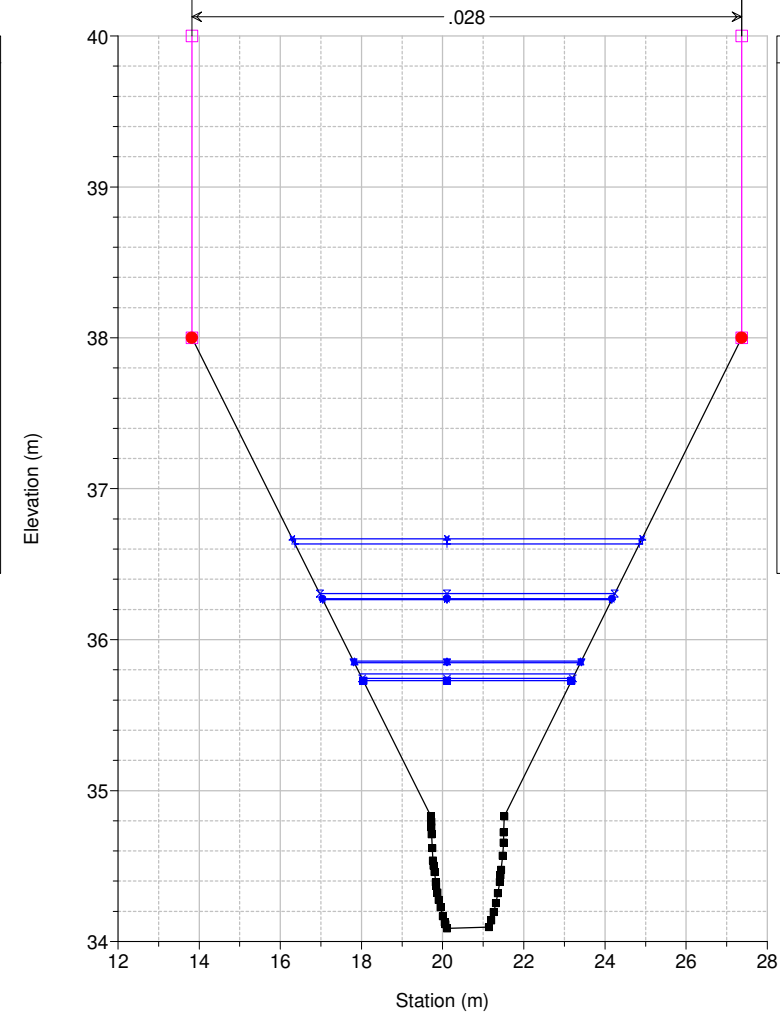

Legend	
WS Max WS - TR200_24_0	▲
WS Max WS - TR200_18_0	+
WS Max WS - TR200_12_0	✕
WS Max WS - TR200_09_0	●
WS Max WS - TR200_36_0	▲
WS Max WS - TR200_01_5	▼
WS Max WS - TR200_01_0	▼
WS Max WS - TR200_00_5	✕
WS Max WS - TR200_03_0	✕
WS Max WS - TR200_06_0	■
Ground	■
Levee	□
Bank Sta	●

Studio Scandicci Torrenti Greve-Vingone
River = Fosso Dogaia Reach = Dogaia_02 RS = 44 DO1014_D

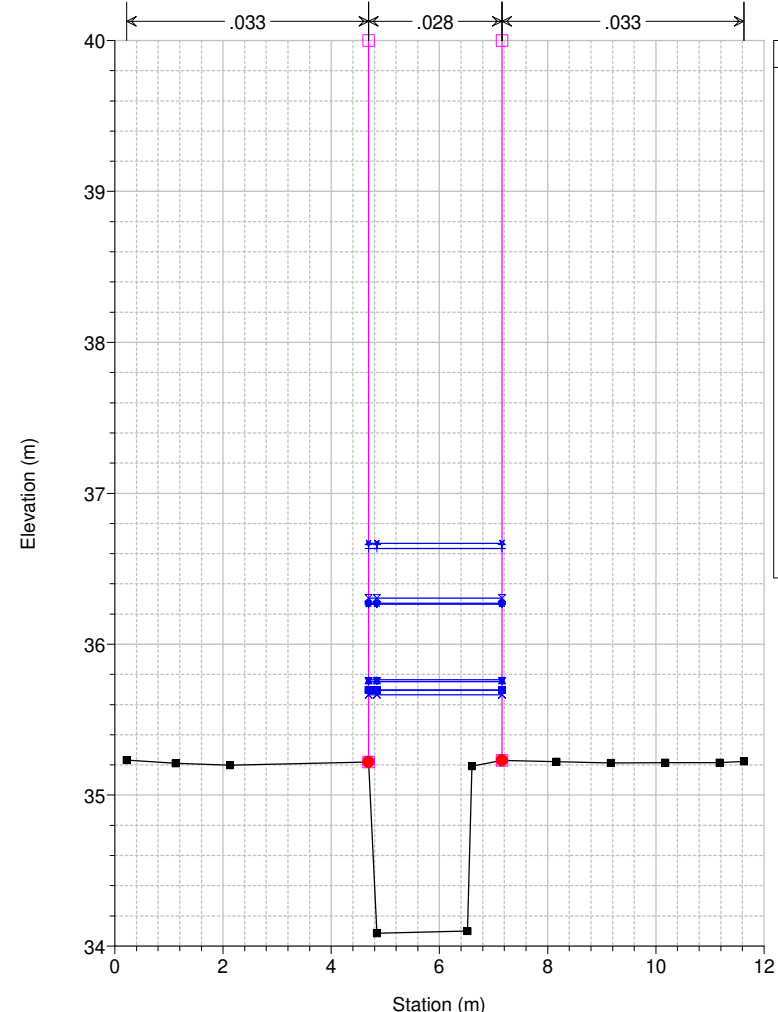

Legend	
WS Max WS - TR200_24_0	▲
WS Max WS - TR200_18_0	▲
WS Max WS - TR200_12_0	▲
WS Max WS - TR200_09_0	▲
WS Max WS - TR200_36_0	▲
WS Max WS - TR200_01_5	▲
WS Max WS - TR200_01_0	▲
WS Max WS - TR200_06_0	■
WS Max WS - TR200_00_5	■
WS Max WS - TR200_03_0	■
Ground	■
Levee	□
Bank Sta	●

Studio Scandicci Torrenti Greve-Vingone
River = Fosso Dogaia Reach = Dogaia_02 RS = 43 DO1015_A

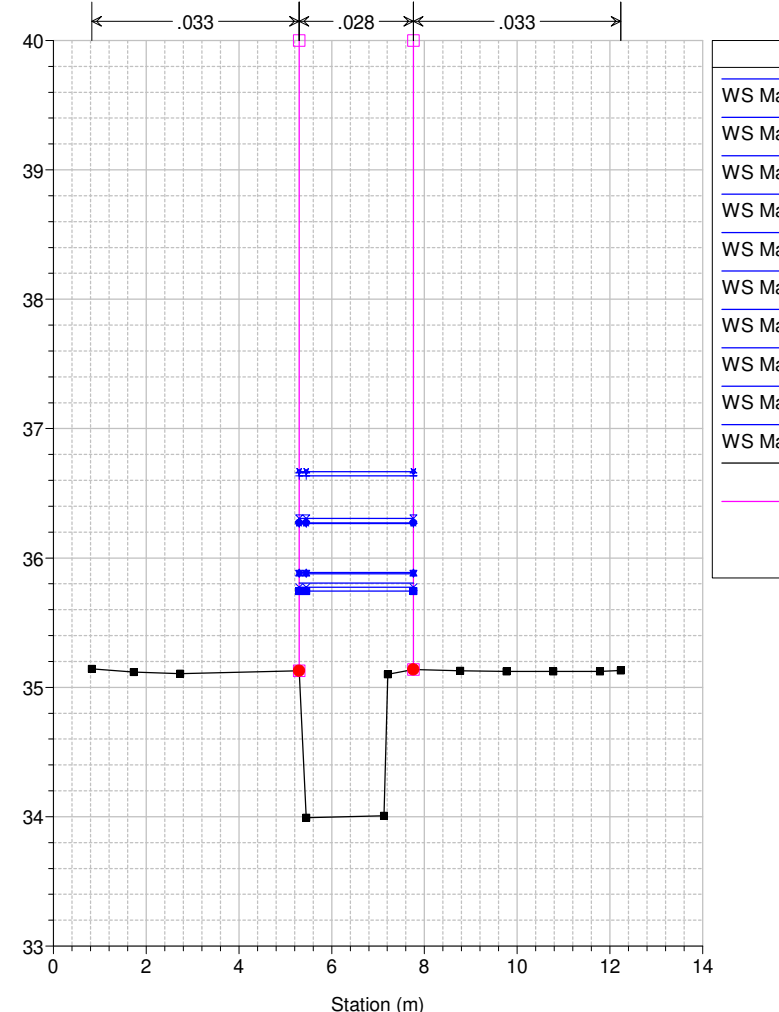

Legend	
WS Max WS - TR200_24_0	▲
WS Max WS - TR200_18_0	▲
WS Max WS - TR200_12_0	▲
WS Max WS - TR200_09_0	▲
WS Max WS - TR200_36_0	▲
WS Max WS - TR200_01_5	▲
WS Max WS - TR200_01_0	▲
WS Max WS - TR200_00_5	■
WS Max WS - TR200_03_0	■
WS Max WS - TR200_06_0	■
Ground	■
Levee	□
Bank Sta	●

Studio Scandicci Torrenti Greve-Vingone
River = Fosso Dogaia Reach = Dogaia_02 RS = 42 DO1015_B

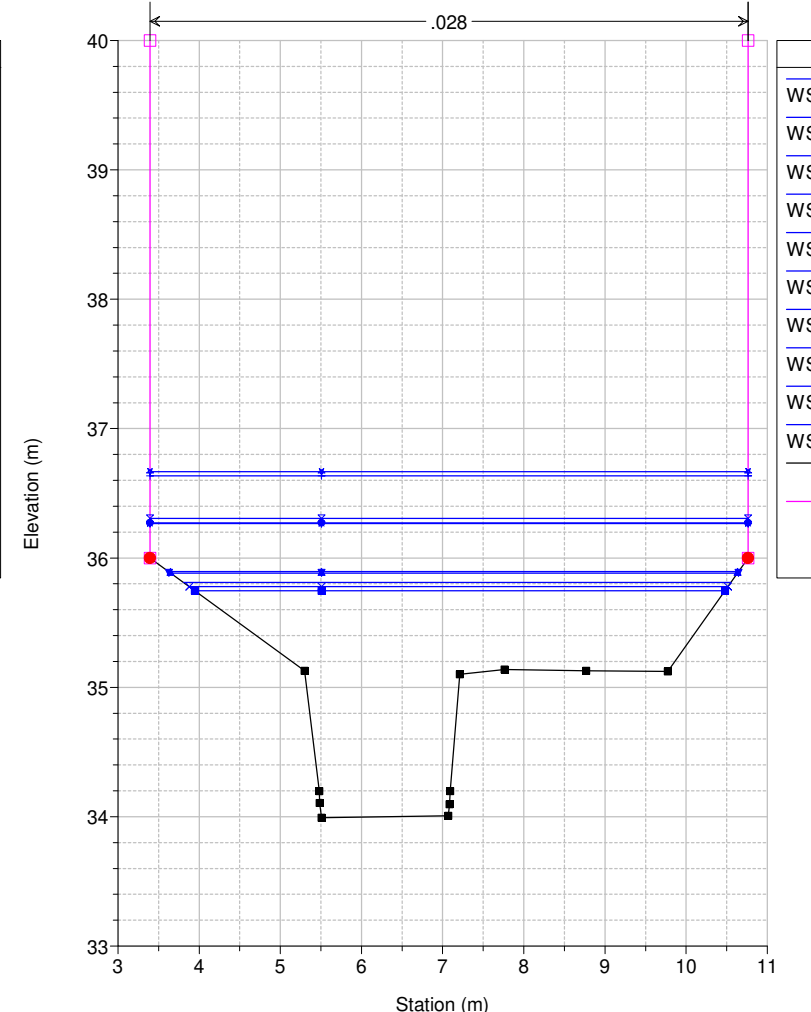

Legend	
WS Max WS - TR200_24_0	▲
WS Max WS - TR200_18_0	▲
WS Max WS - TR200_12_0	▲
WS Max WS - TR200_09_0	▲
WS Max WS - TR200_36_0	▲
WS Max WS - TR200_01_5	▲
WS Max WS - TR200_01_0	▲
WS Max WS - TR200_00_5	■
WS Max WS - TR200_03_0	■
WS Max WS - TR200_06_0	■
Ground	■
Levee	□
Bank Sta	●

Studio Scandicci Torrenti Greve-Vingone
River = Fosso Dogaia Reach = Dogaia_02 RS = 41.5 BR

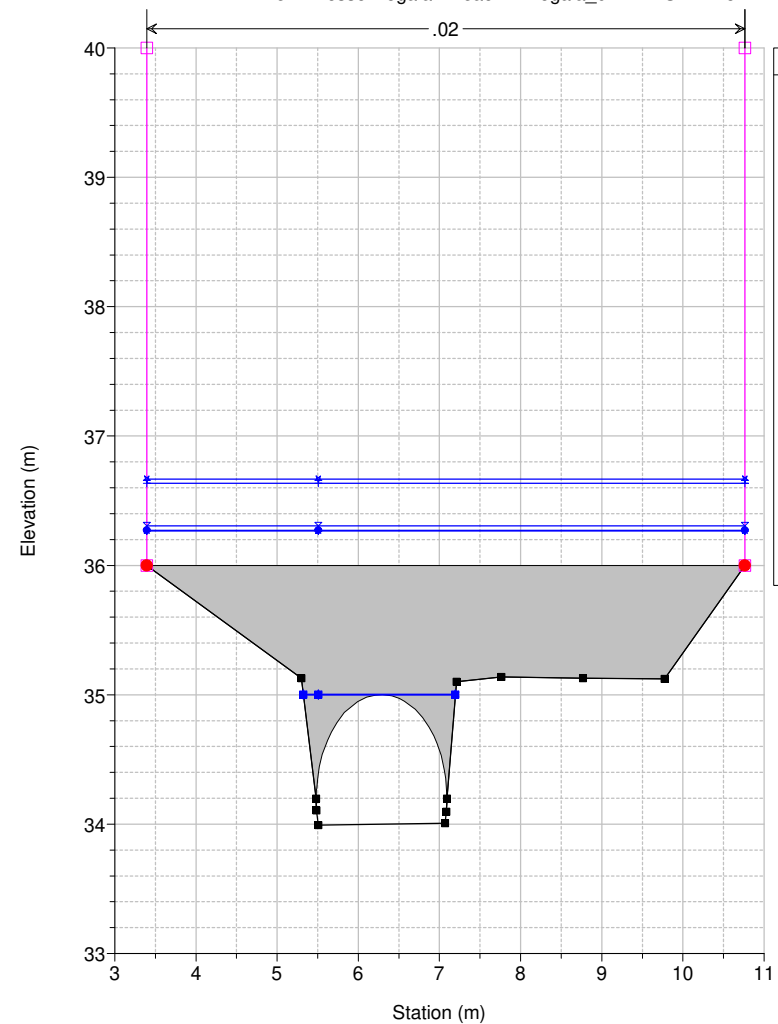

Legend	
WS Max WS - TR200_24_0	▲
WS Max WS - TR200_18_0	▲
WS Max WS - TR200_12_0	▲
WS Max WS - TR200_09_0	▲
WS Max WS - TR200_36_0	▲
WS Max WS - TR200_03_0	▲
WS Max WS - TR200_01_5	▲
WS Max WS - TR200_01_0	▲
WS Max WS - TR200_00_5	■
WS Max WS - TR200_06_0	■
Ground	■
Levee	□
Bank Sta	●

Studio Scandicci Torrenti Greve-Vingone
River = Fosso Dogaia Reach = Dogaia_02 RS = 41.5 BR

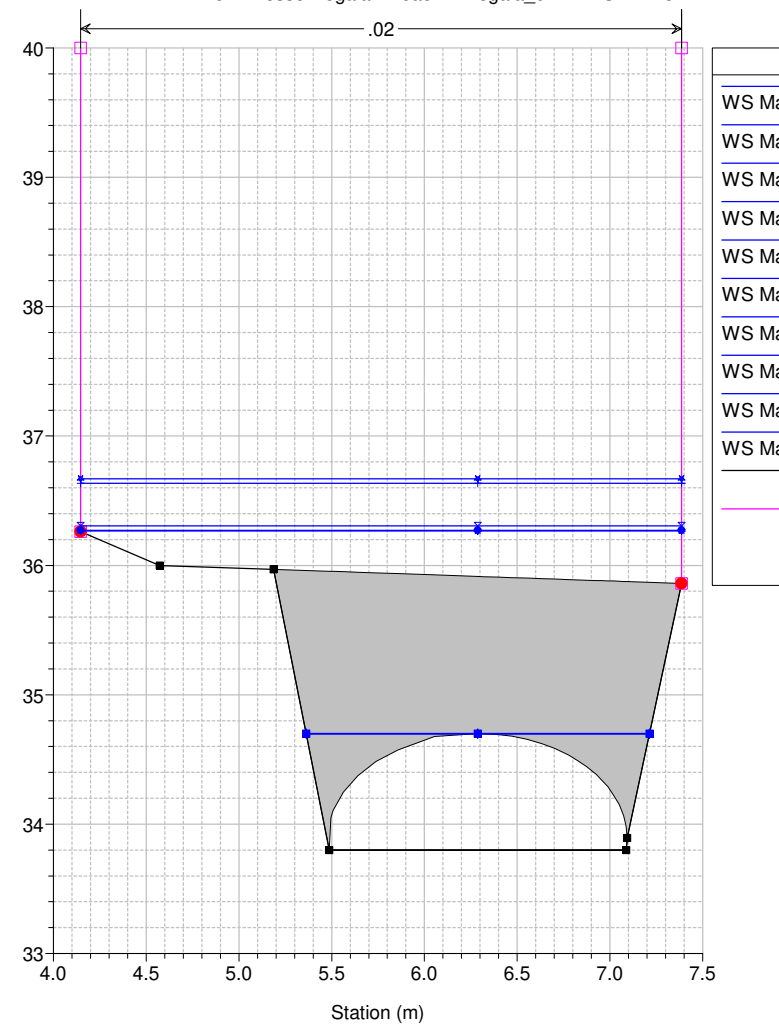

Legend	
WS Max WS - TR200_24_0	▲
WS Max WS - TR200_18_0	▲
WS Max WS - TR200_12_0	▲
WS Max WS - TR200_09_0	▲
WS Max WS - TR200_36_0	▲
WS Max WS - TR200_03_0	▲
WS Max WS - TR200_01_5	▲
WS Max WS - TR200_01_0	▲
WS Max WS - TR200_00_5	■
WS Max WS - TR200_06_0	■
Ground	■
Levee	□
Bank Sta	●

Studio Scandicci Torrenti Greve-Vingone
River = Fosso Dogaia Reach = Dogaia_02 RS = 41 DO1015_C

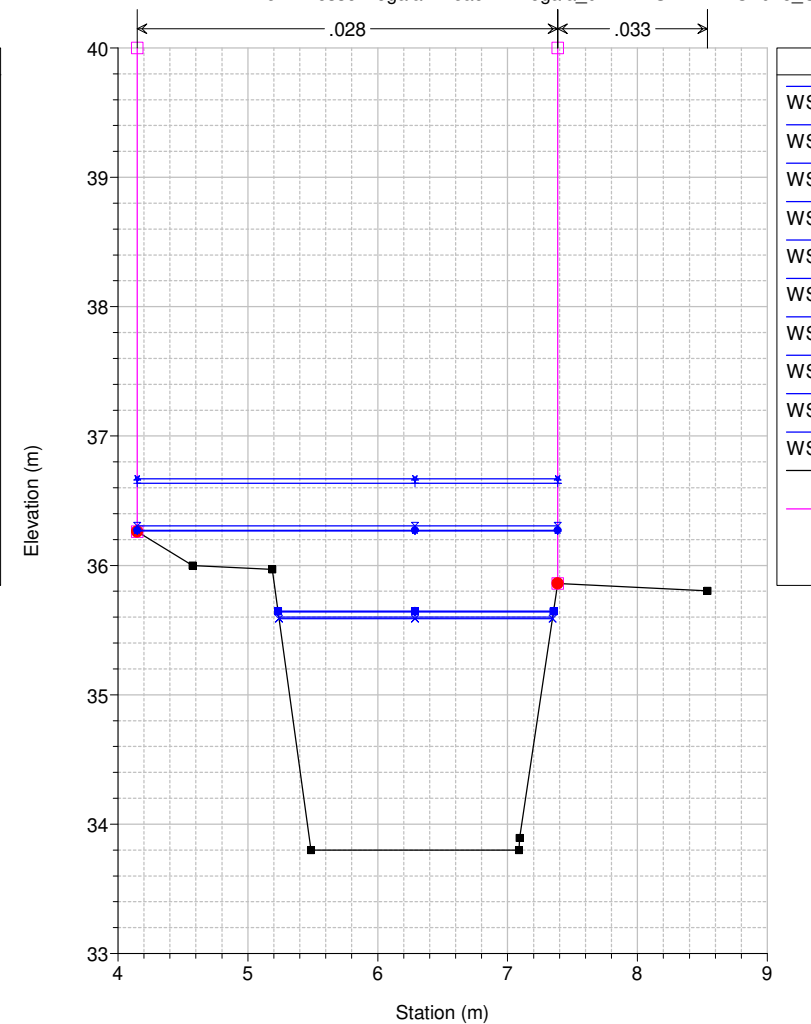

Legend	
WS Max WS - TR200_24_0	▲
WS Max WS - TR200_18_0	▲
WS Max WS - TR200_12_0	▲
WS Max WS - TR200_09_0	▲
WS Max WS - TR200_36_0	▲
WS Max WS - TR200_01_5	▲
WS Max WS - TR200_06_0	▲
WS Max WS - TR200_01_0	▲
WS Max WS - TR200_00_5	■
WS Max WS - TR200_03_0	■
Ground	■
Levee	□
Bank Sta	●

Studio Scandicci Torrenti Greve-Vingone
River = Fosso Dogaia Reach = Dogaia_02 RS = 36 DO1016_D

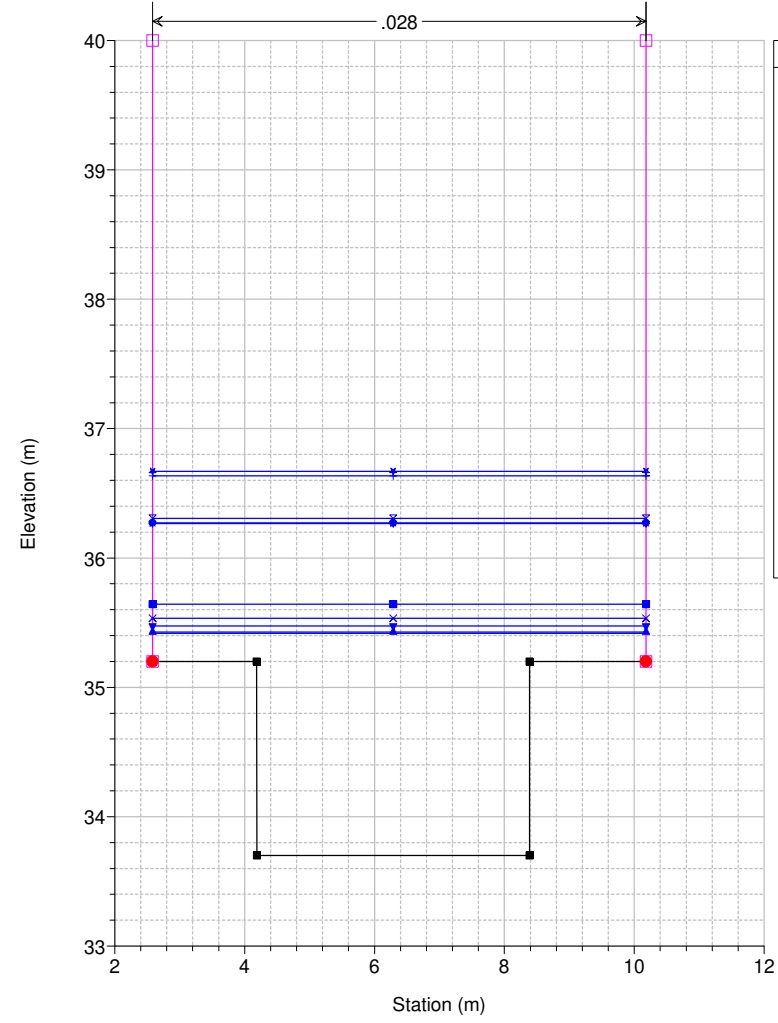

Legend	
WS Max WS - TR200_24_0	▲
WS Max WS - TR200_18_0	+
WS Max WS - TR200_12_0	×
WS Max WS - TR200_09_0	●
WS Max WS - TR200_36_0	■
WS Max WS - TR200_06_0	◆
WS Max WS - TR200_03_0	×
WS Max WS - TR200_01_5	▼
WS Max WS - TR200_01_0	▲
WS Max WS - TR200_00_5	■
Ground	■
Levee	□
Bank Sta	●

Studio Scandicci Torrenti Greve-Vingone
River = Fosso Dogaia Reach = Dogaia_02 RS = 35 DO1017_A

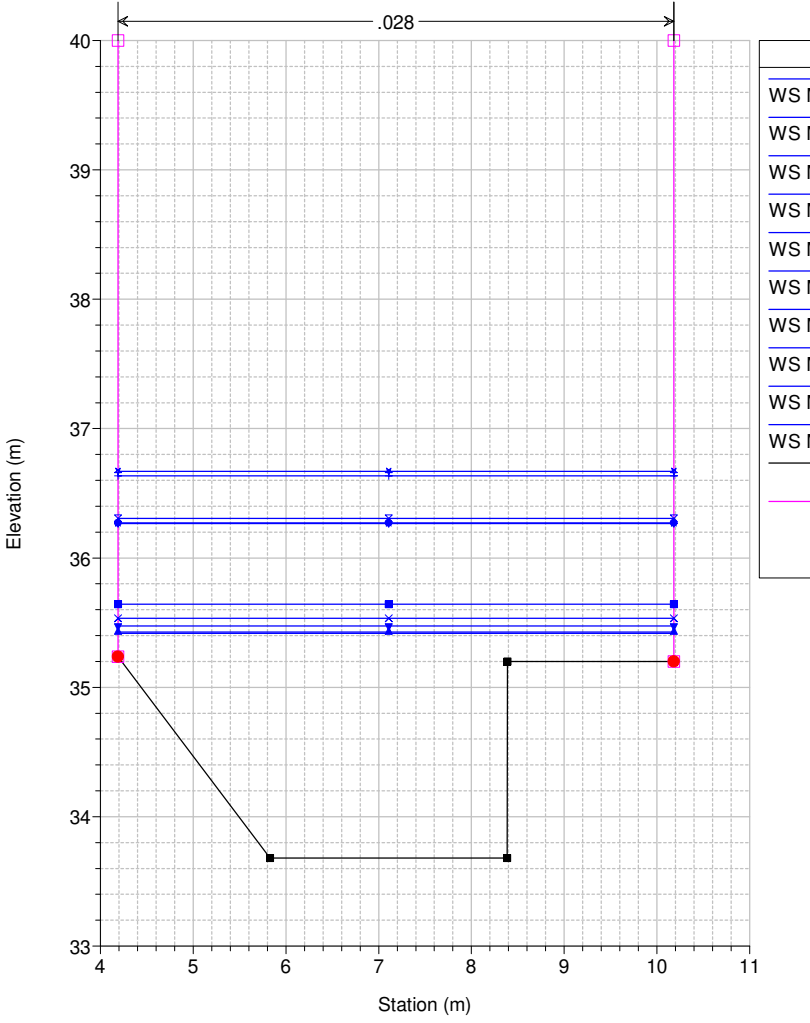

Legend	
WS Max WS - TR200_24_0	▲
WS Max WS - TR200_18_0	+
WS Max WS - TR200_12_0	×
WS Max WS - TR200_09_0	●
WS Max WS - TR200_36_0	■
WS Max WS - TR200_06_0	◆
WS Max WS - TR200_03_0	×
WS Max WS - TR200_01_5	▼
WS Max WS - TR200_01_0	▲
WS Max WS - TR200_00_5	■
Ground	■
Levee	□
Bank Sta	●

Studio Scandicci Torrenti Greve-Vingone
River = Fosso Dogaia Reach = Dogaia_02 RS = 34 DO1017_B

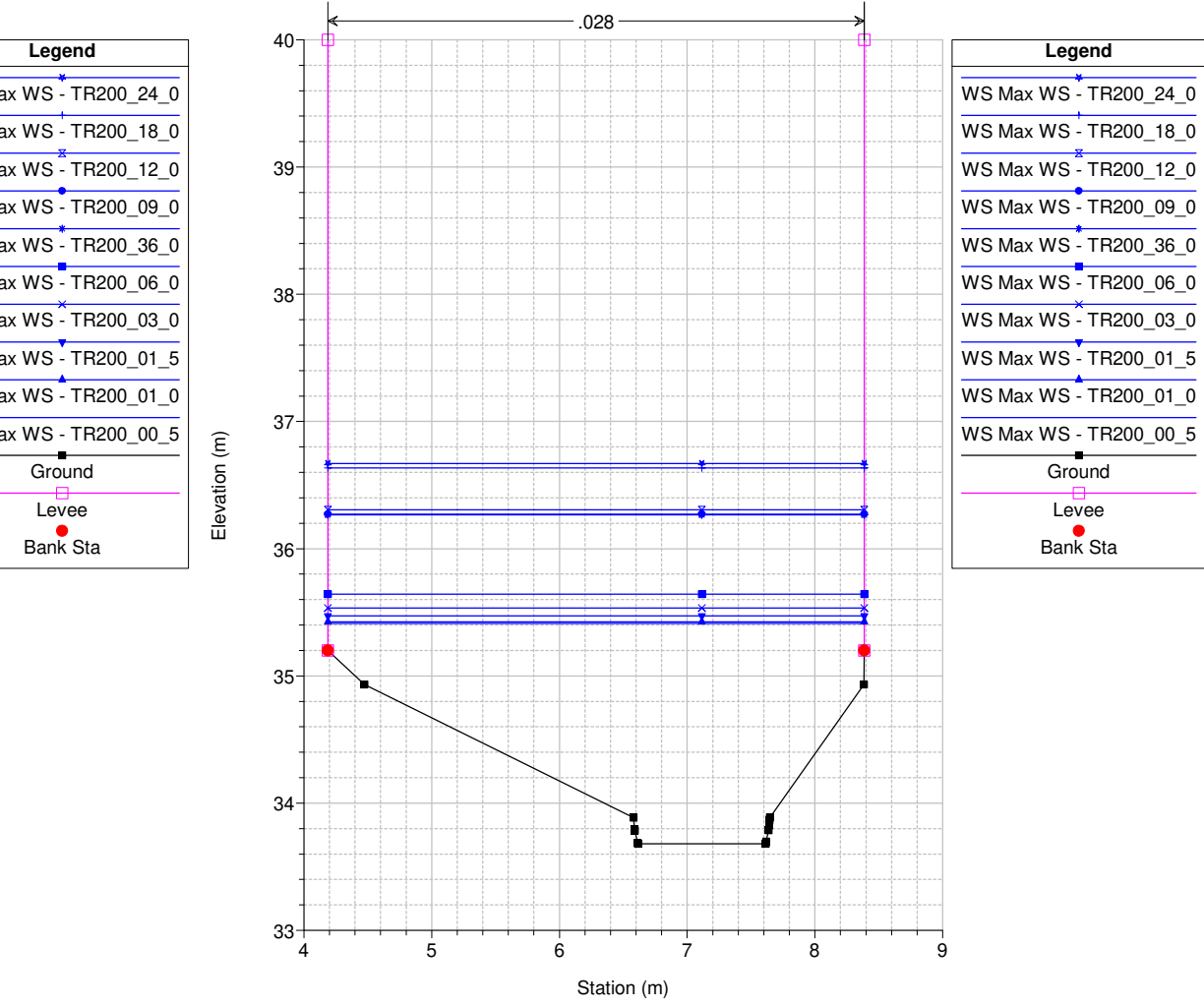

Legend	
WS Max WS - TR200_24_0	▲
WS Max WS - TR200_18_0	+
WS Max WS - TR200_12_0	×
WS Max WS - TR200_09_0	●
WS Max WS - TR200_36_0	■
WS Max WS - TR200_06_0	◆
WS Max WS - TR200_03_0	×
WS Max WS - TR200_01_5	▼
WS Max WS - TR200_01_0	▲
WS Max WS - TR200_00_5	■
Ground	■
Levee	□
Bank Sta	●

Studio Scandicci Torrenti Greve-Vingone
River = Fosso Dogaia Reach = Dogaia_02 RS = 33.5 BR

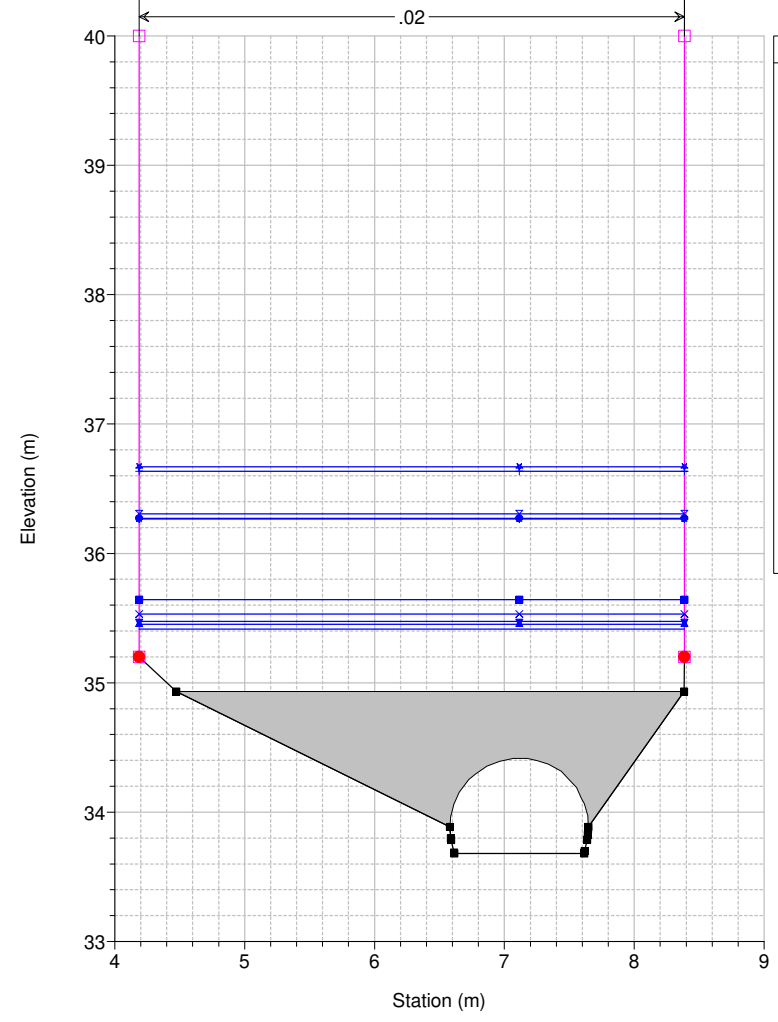

Legend	
WS Max WS - TR200_24_0	▲
WS Max WS - TR200_18_0	+
WS Max WS - TR200_12_0	×
WS Max WS - TR200_09_0	●
WS Max WS - TR200_36_0	■
WS Max WS - TR200_06_0	◆
WS Max WS - TR200_03_0	×
WS Max WS - TR200_01_5	▼
WS Max WS - TR200_01_0	▲
WS Max WS - TR200_00_5	■
Ground	■
Levee	□
Bank Sta	●

Studio Scandicci Torrenti Greve-Vingone
River = Fosso Dogaia Reach = Dogaia_02 RS = 33.5 BR

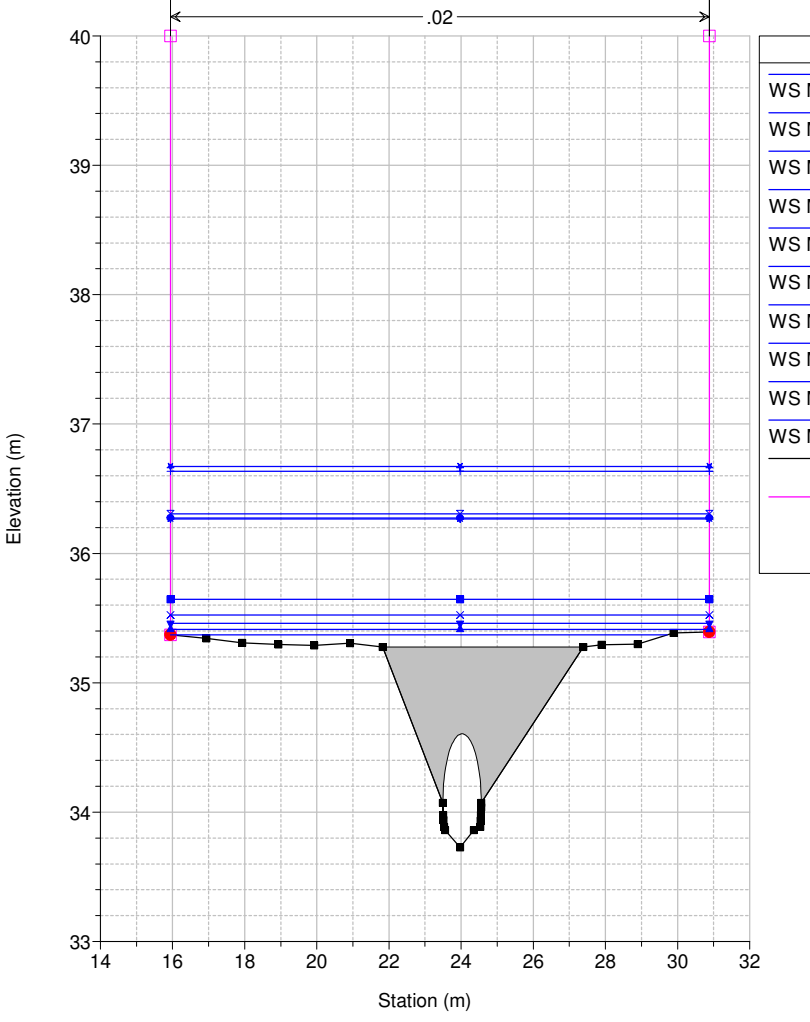

Legend	
WS Max WS - TR200_24_0	▲
WS Max WS - TR200_18_0	+
WS Max WS - TR200_12_0	×
WS Max WS - TR200_09_0	●
WS Max WS - TR200_36_0	■
WS Max WS - TR200_06_0	◆
WS Max WS - TR200_03_0	×
WS Max WS - TR200_01_5	▼
WS Max WS - TR200_01_0	▲
WS Max WS - TR200_00_5	■
Ground	■
Levee	□
Bank Sta	●

Studio Scandicci Torrenti Greve-Vingone
River = Fosso Dogaia Reach = Dogaia_02 RS = 33 DO1017_C

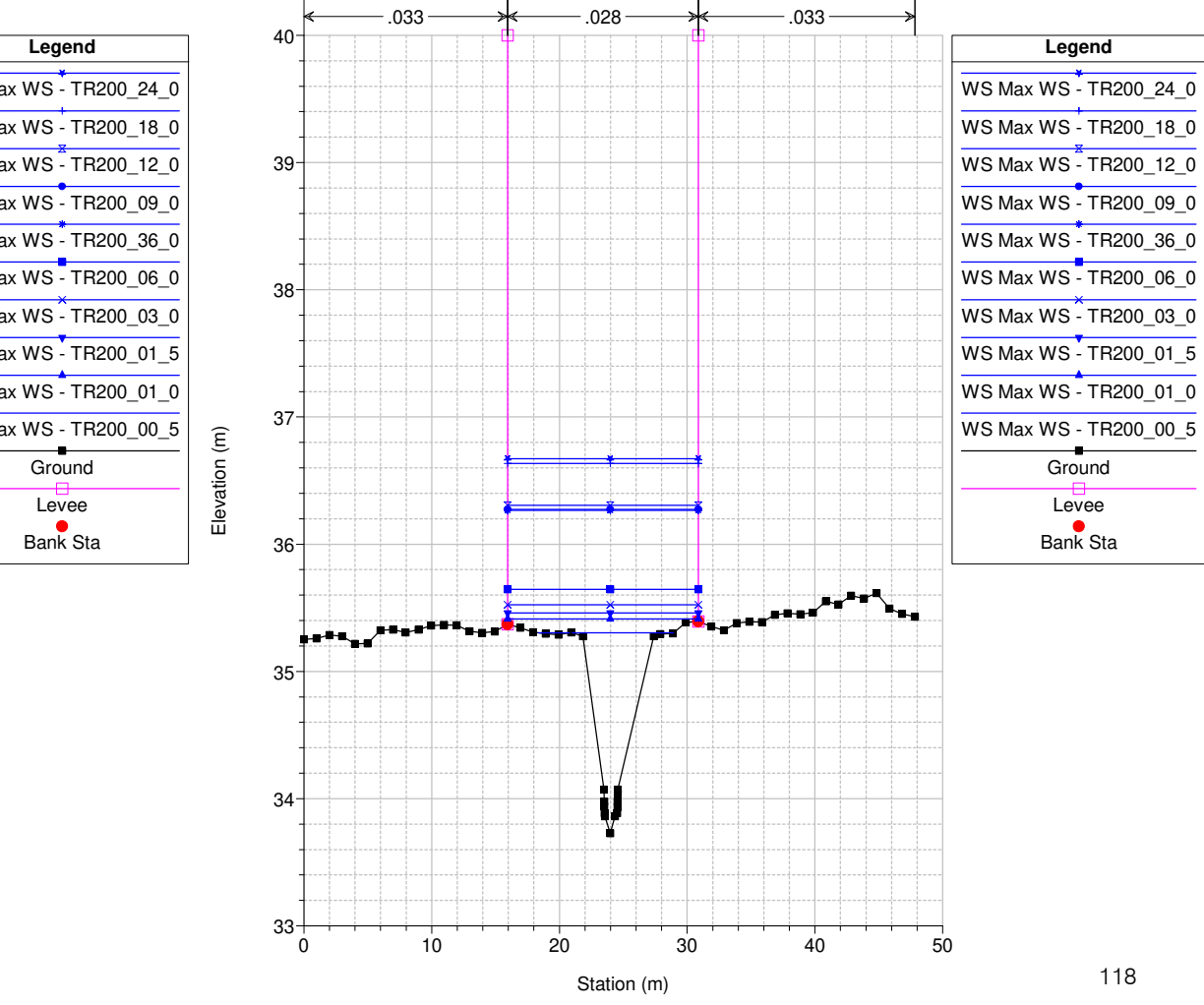

Legend	
WS Max WS - TR200_24_0	▲
WS Max WS - TR200_18_0	+
WS Max WS - TR200_12_0	×
WS Max WS - TR200_09_0	●
WS Max WS - TR200_36_0	■
WS Max WS - TR200_06_0	◆
WS Max WS - TR200_03_0	×
WS Max WS - TR200_01_5	▼
WS Max WS - TR200_01_0	▲
WS Max WS - TR200_00_5	■
Ground	■
Levee	□
Bank Sta	●

Studio Scandicci Torrenti Greve-Vingone
River = Fosso Dogaia Reach = Dogaia_02 RS = 32 DO0017_D

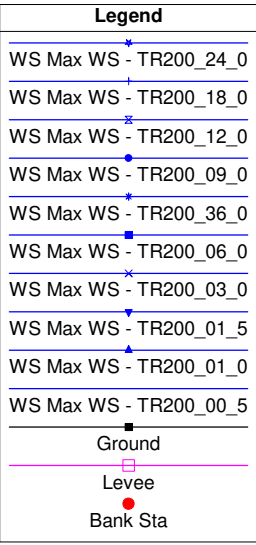
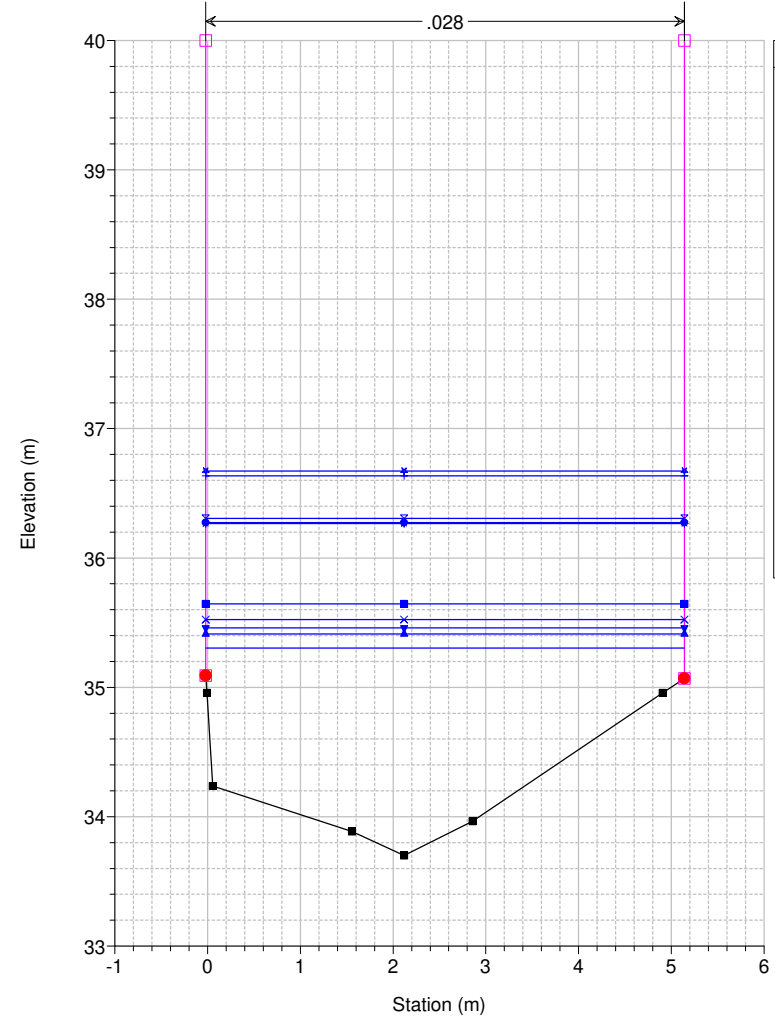

Studio Scandicci Torrenti Greve-Vingone
River = Fosso Dogaia Reach = Dogaia_02 RS = 31 DO0018_

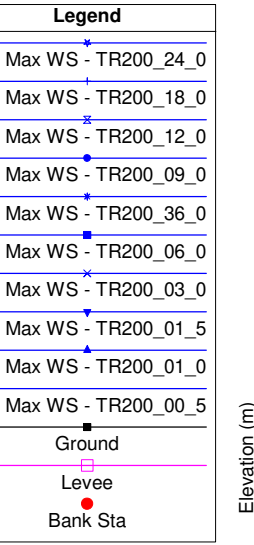
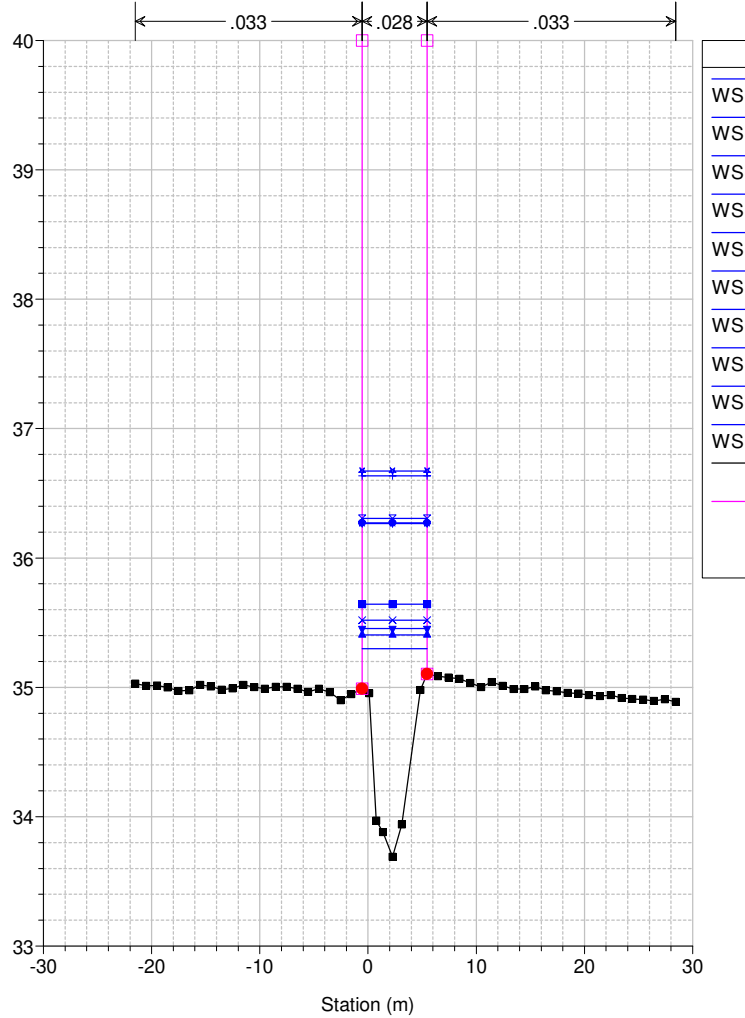

Studio Scandicci Torrenti Greve-Vingone
River = Fosso Dogaia Reach = Dogaia_02 RS = 30 DO0019_

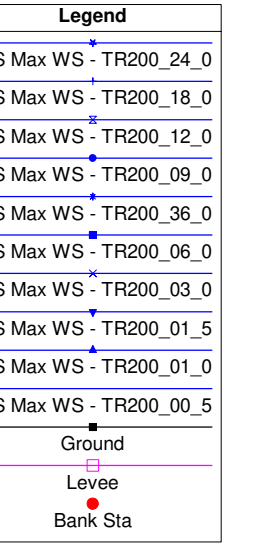
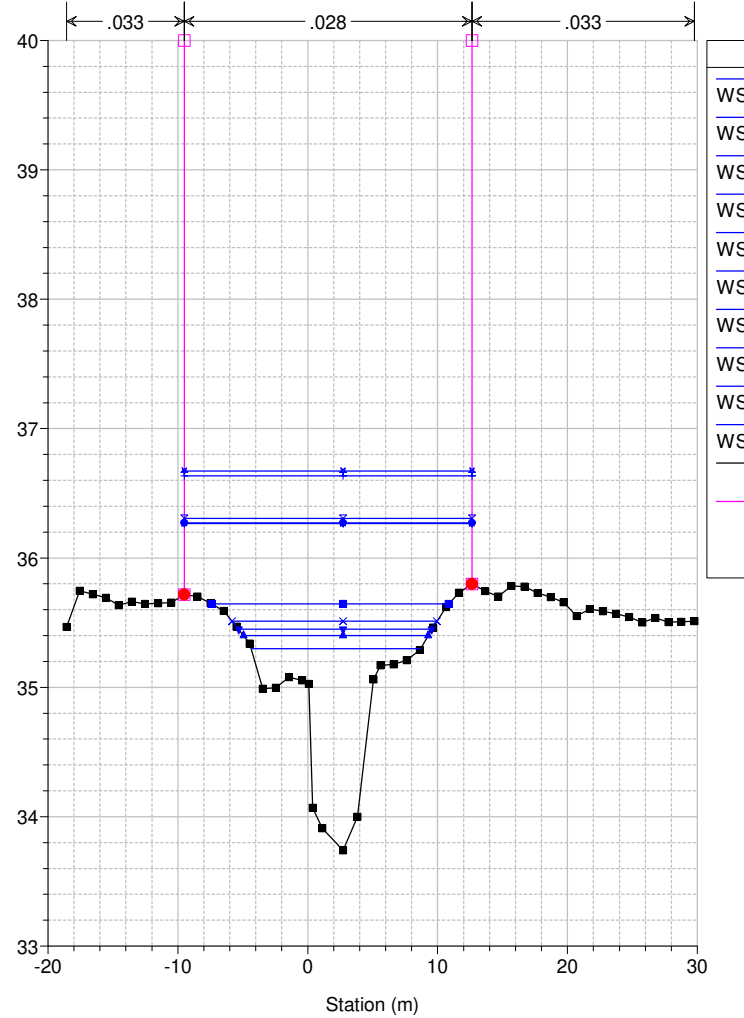

Studio Scandicci Torrenti Greve-Vingone
River = Fosso Dogaia Reach = Dogaia_02 RS = 29 DO0020_

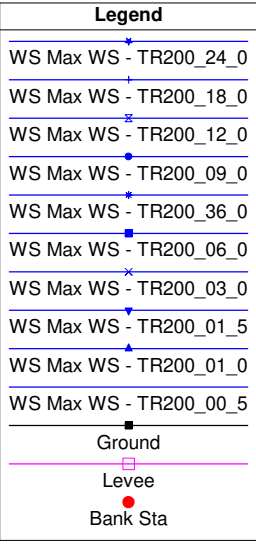
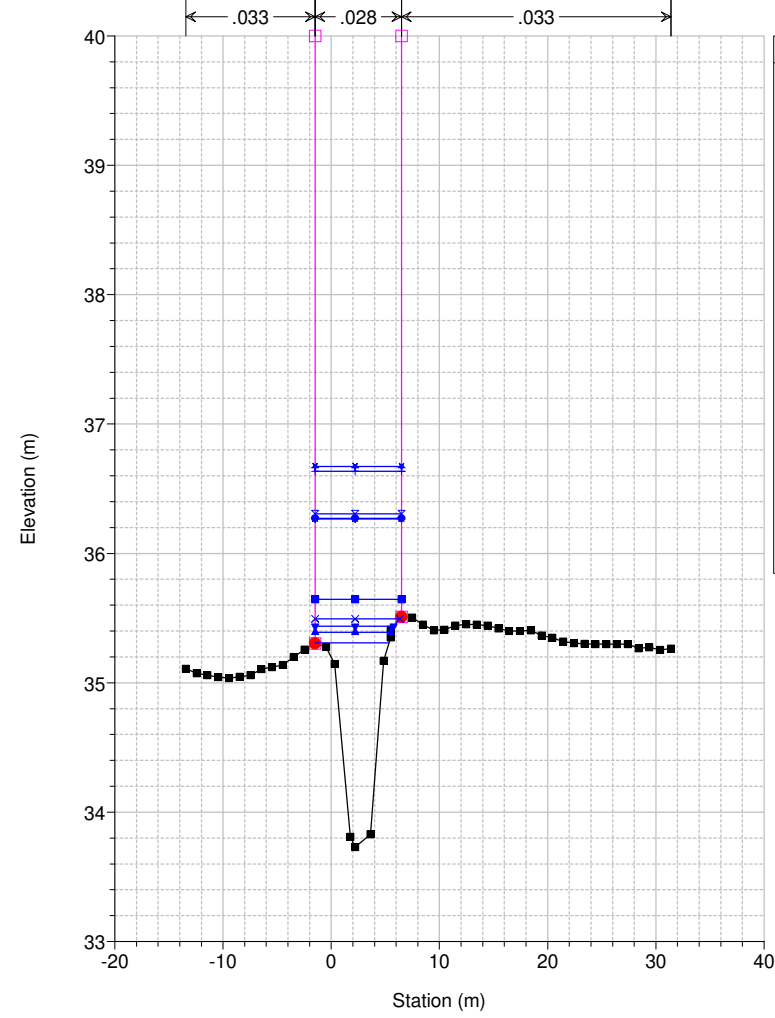

Studio Scandicci Torrenti Greve-Vingone
River = Fosso Dogaia Reach = Dogaia_02 RS = 28 DO1020_A

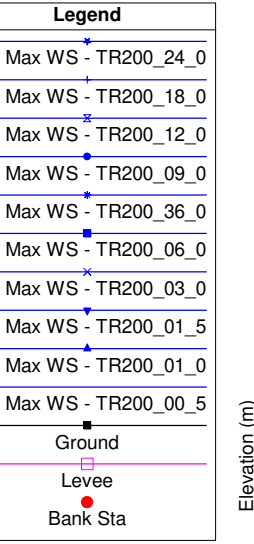
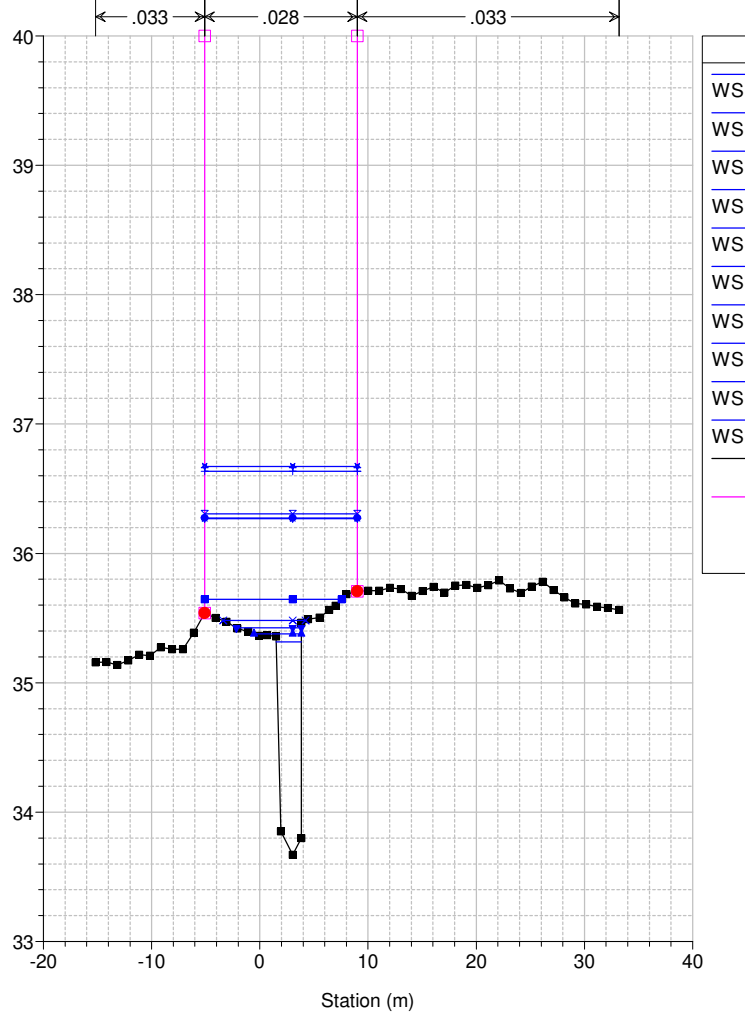

Studio Scandicci Torrenti Greve-Vingone
River = Fosso Dogaia Reach = Dogaia_02 RS = 27 DO1020_B

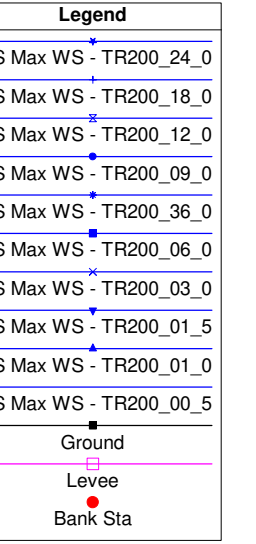
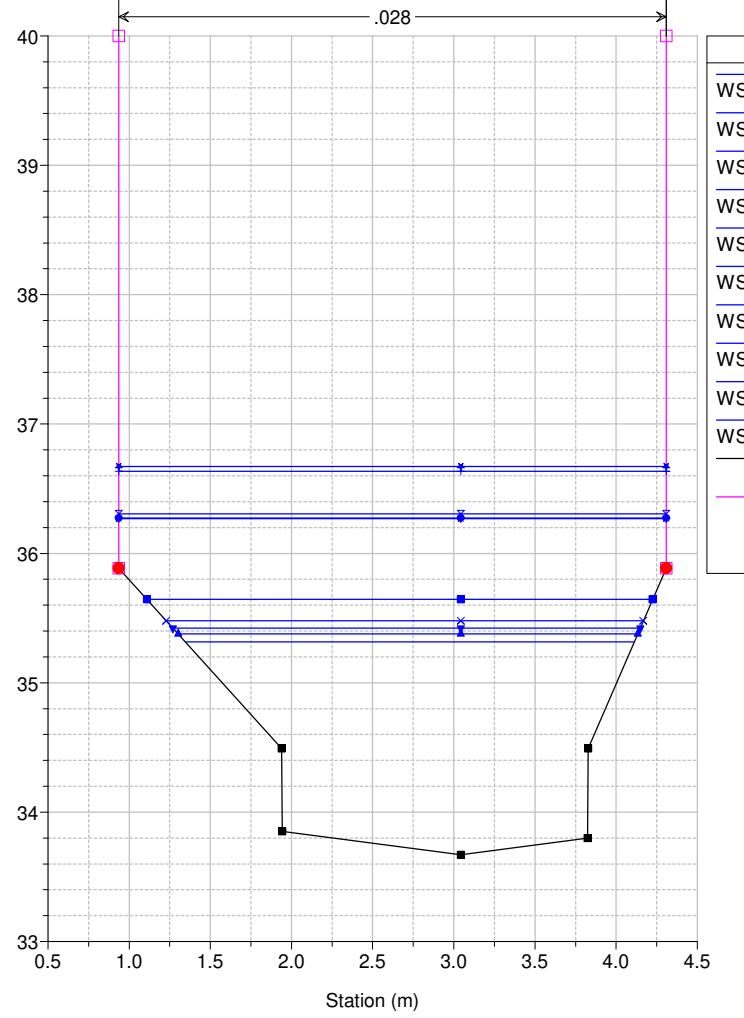

Studio Scandicci Torrenti Greve-Vingone
River = Fosso Dogaia Reach = Dogaia_02 RS = 26.5 BR

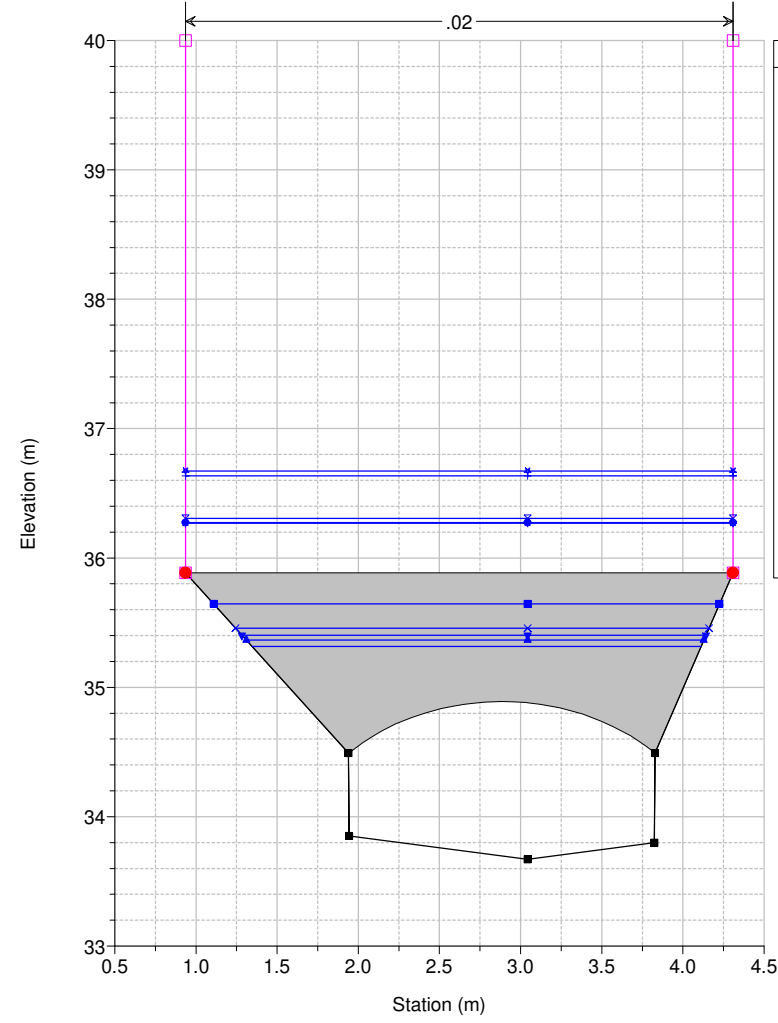

Legend	
WS Max WS - TR200_24_0	▲
WS Max WS - TR200_18_0	+
WS Max WS - TR200_12_0	×
WS Max WS - TR200_09_0	●
WS Max WS - TR200_36_0	■
WS Max WS - TR200_06_0	□
WS Max WS - TR200_03_0	×
WS Max WS - TR200_01_5	▼
WS Max WS - TR200_01_0	▲
WS Max WS - TR200_00_5	▲
Ground	■
Levee	□
Bank Sta	●

Studio Scandicci Torrenti Greve-Vingone
River = Fosso Dogaia Reach = Dogaia_02 RS = 26.5 BR

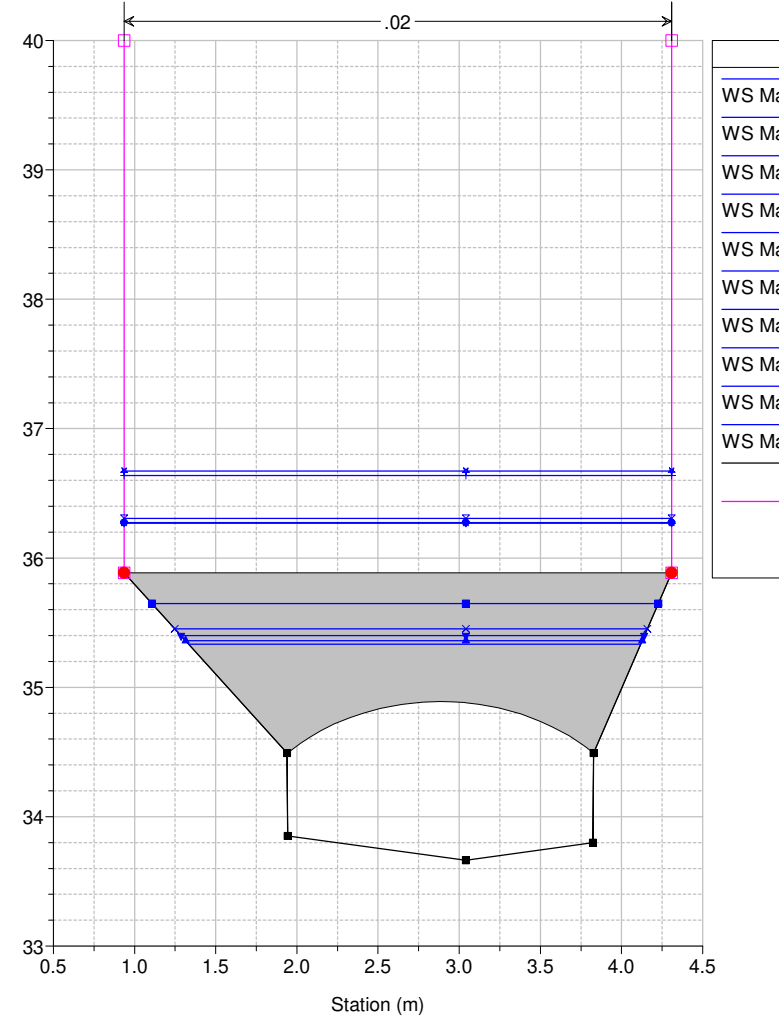

Legend	
WS Max WS - TR200_24_0	▲
WS Max WS - TR200_18_0	+
WS Max WS - TR200_12_0	×
WS Max WS - TR200_09_0	●
WS Max WS - TR200_36_0	■
WS Max WS - TR200_06_0	□
WS Max WS - TR200_03_0	×
WS Max WS - TR200_01_5	▼
WS Max WS - TR200_01_0	▲
WS Max WS - TR200_00_5	▲
Ground	■
Levee	□
Bank Sta	●

Studio Scandicci Torrenti Greve-Vingone
River = Fosso Dogaia Reach = Dogaia_02 RS = 26 DO1020_C

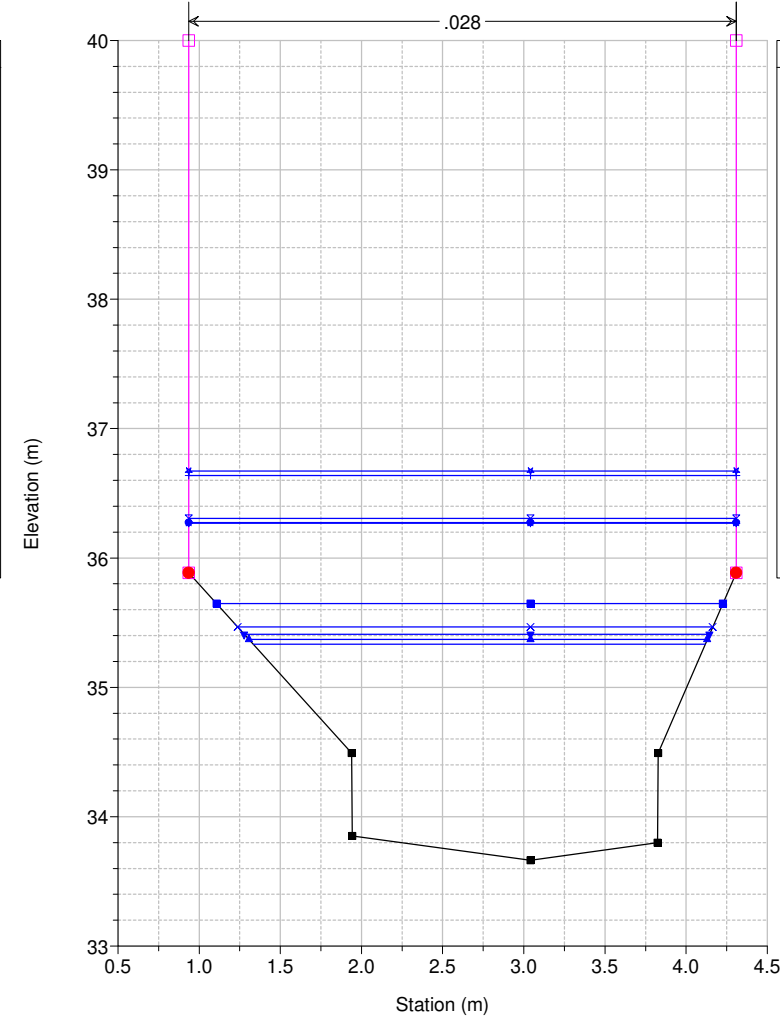

Legend	
WS Max WS - TR200_24_0	▲
WS Max WS - TR200_18_0	+
WS Max WS - TR200_12_0	×
WS Max WS - TR200_09_0	●
WS Max WS - TR200_36_0	■
WS Max WS - TR200_06_0	□
WS Max WS - TR200_03_0	×
WS Max WS - TR200_01_5	▼
WS Max WS - TR200_01_0	▲
WS Max WS - TR200_00_5	▲
Ground	■
Levee	□
Bank Sta	●

Studio Scandicci Torrenti Greve-Vingone
River = Fosso Dogaia Reach = Dogaia_02 RS = 25 DO1020_D

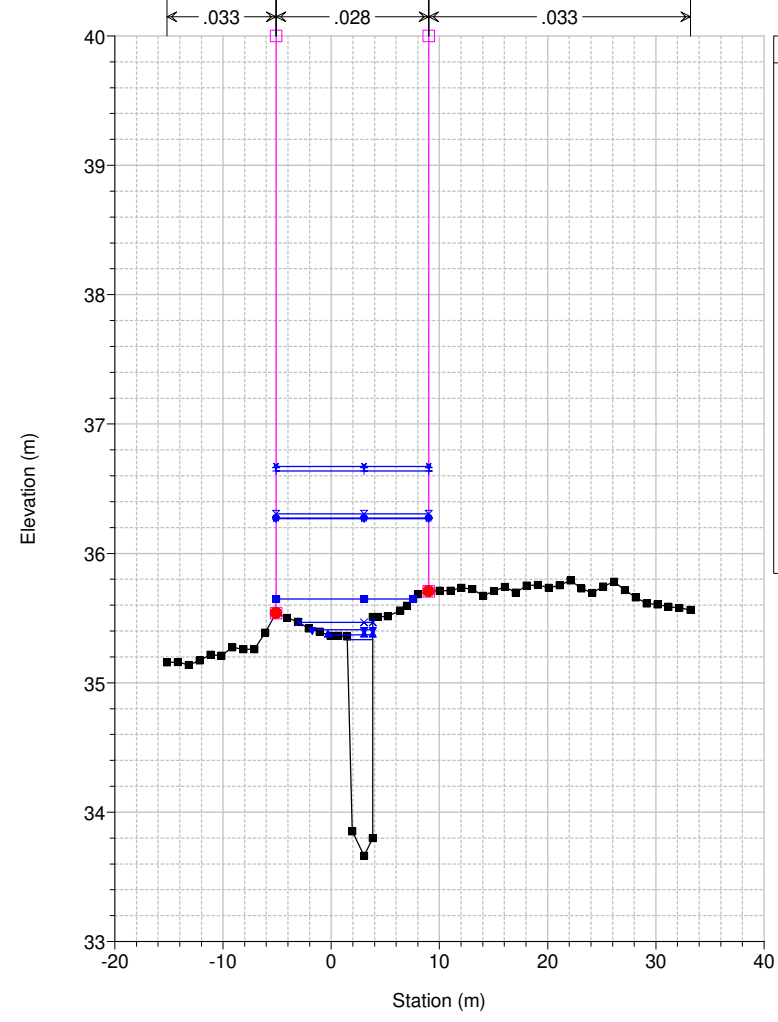

Legend	
WS Max WS - TR200_24_0	▲
WS Max WS - TR200_18_0	+
WS Max WS - TR200_12_0	×
WS Max WS - TR200_09_0	●
WS Max WS - TR200_36_0	■
WS Max WS - TR200_06_0	□
WS Max WS - TR200_03_0	×
WS Max WS - TR200_01_5	▼
WS Max WS - TR200_01_0	▲
WS Max WS - TR200_00_5	▲
Ground	■
Levee	□
Bank Sta	●

Studio Scandicci Torrenti Greve-Vingone
River = Fosso Dogaia Reach = Dogaia_02 RS = 24 DO0021__



Legend	
WS Max WS - TR200_24_0	▲
WS Max WS - TR200_18_0	+
WS Max WS - TR200_12_0	×
WS Max WS - TR200_09_0	●
WS Max WS - TR200_36_0	■
WS Max WS - TR200_06_0	□
WS Max WS - TR200_03_0	×
WS Max WS - TR200_01_5	▼
WS Max WS - TR200_01_0	▲
WS Max WS - TR200_00_5	▲
Ground	■
Levee	□
Bank Sta	●

Studio Scandicci Torrenti Greve-Vingone
River = Fosso Dogaia Reach = Dogaia_02 RS = 23 DO1021_A

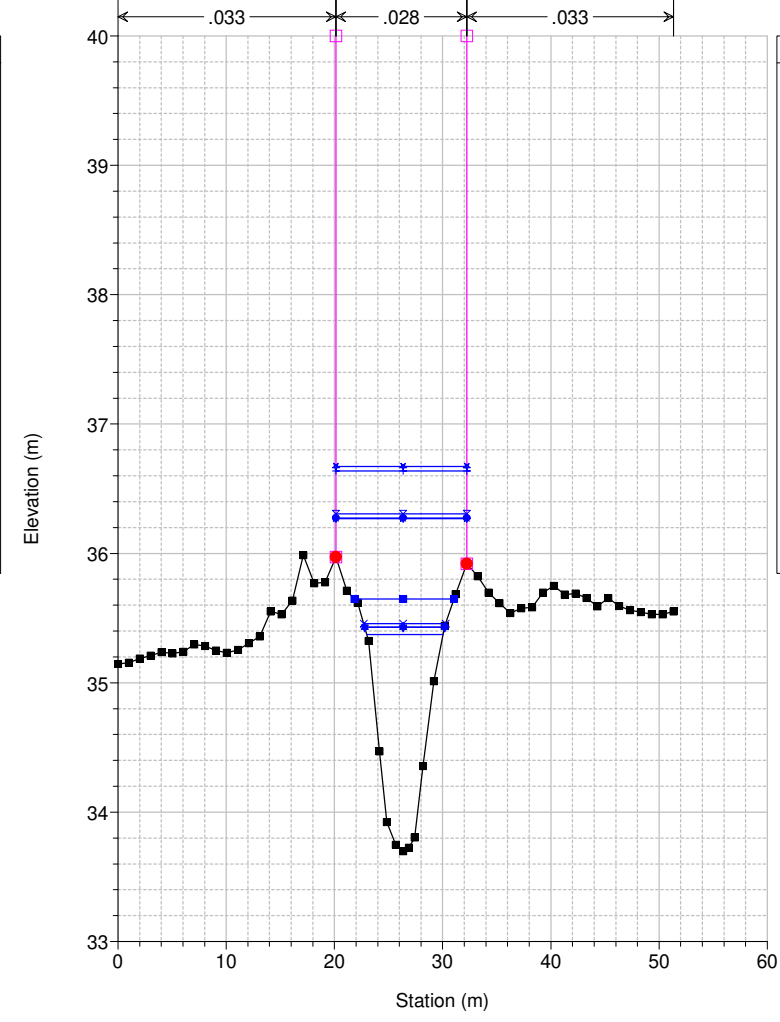

Legend	
WS Max WS - TR200_24_0	▲
WS Max WS - TR200_18_0	+
WS Max WS - TR200_12_0	×
WS Max WS - TR200_09_0	●
WS Max WS - TR200_36_0	■
WS Max WS - TR200_06_0	□
WS Max WS - TR200_03_0	×
WS Max WS - TR200_01_5	▼
WS Max WS - TR200_01_0	▲
WS Max WS - TR200_00_5	▲
Ground	■
Levee	□
Bank Sta	●

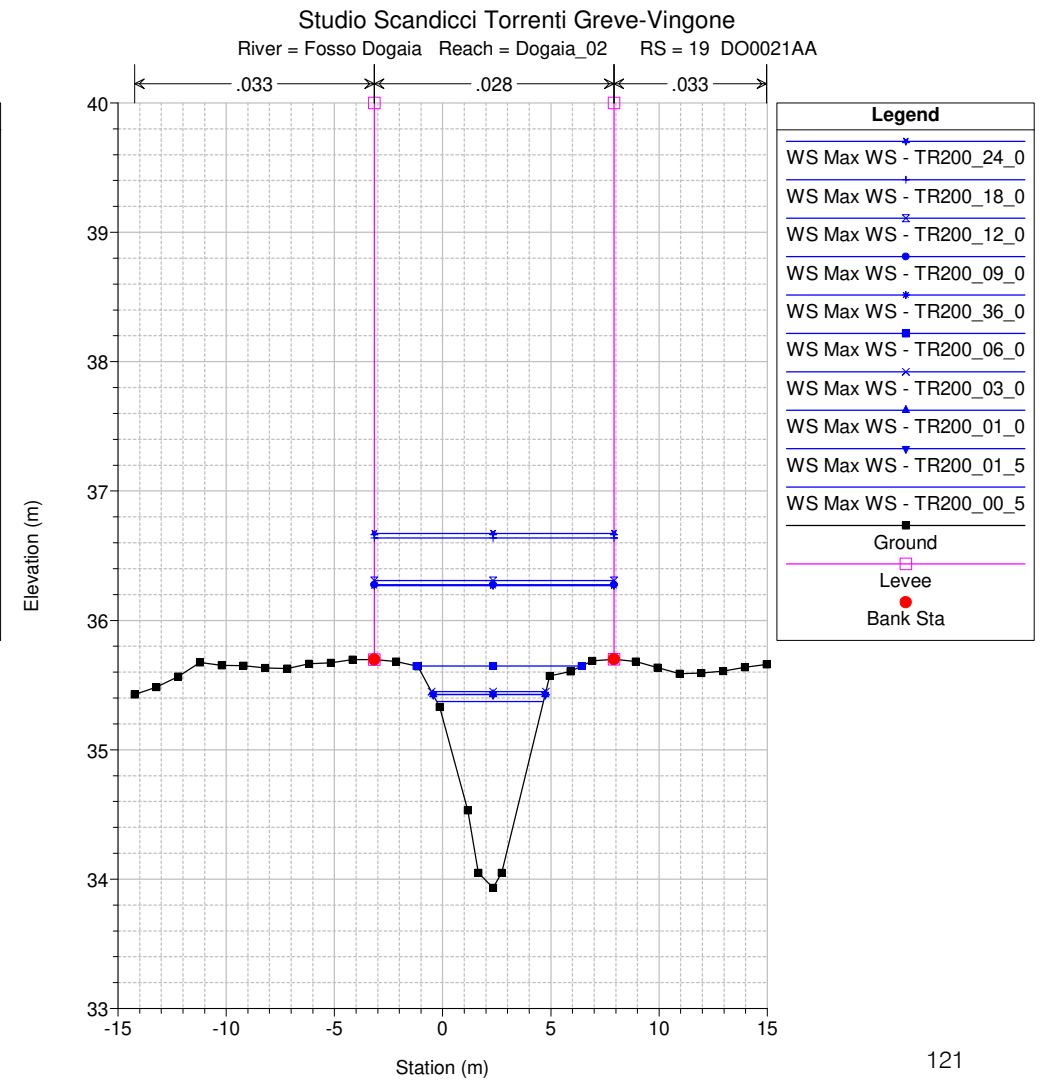
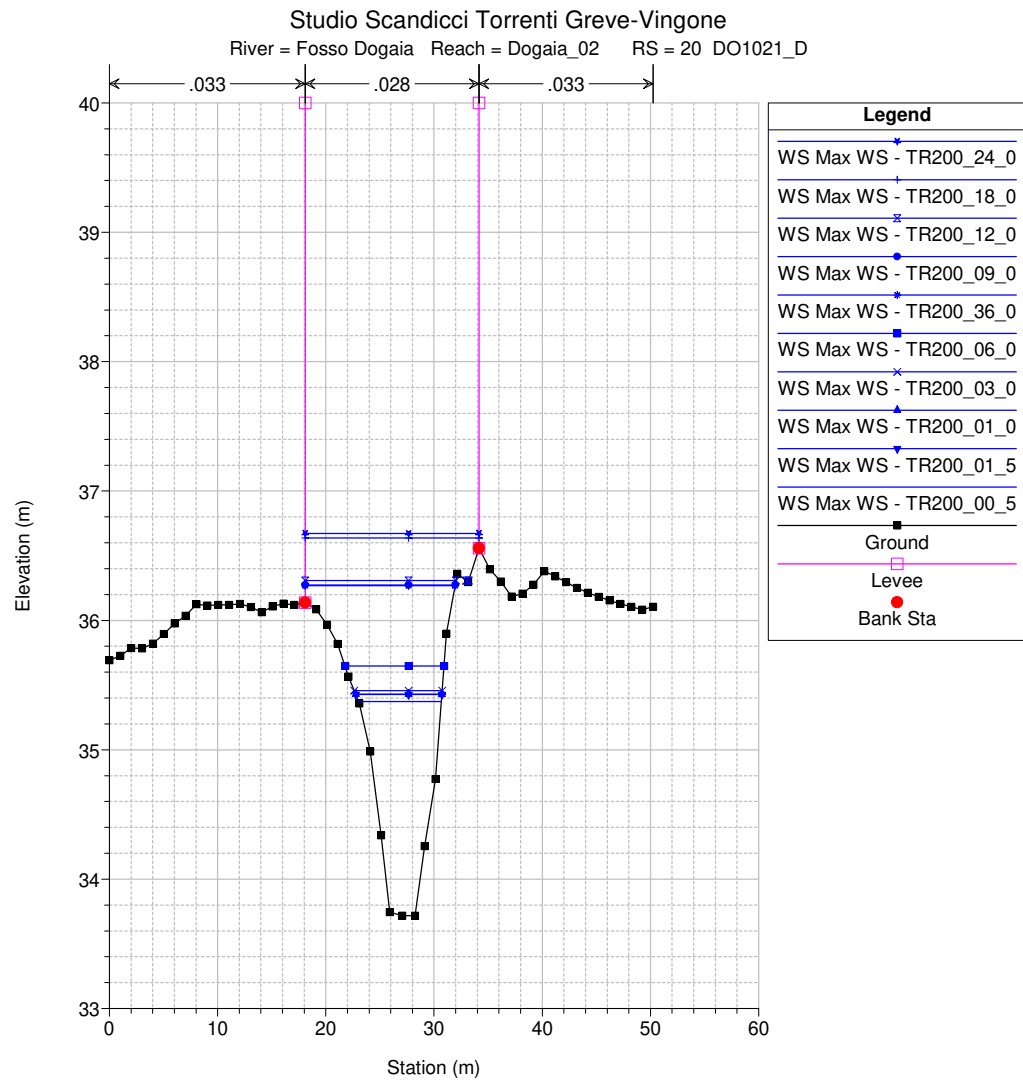
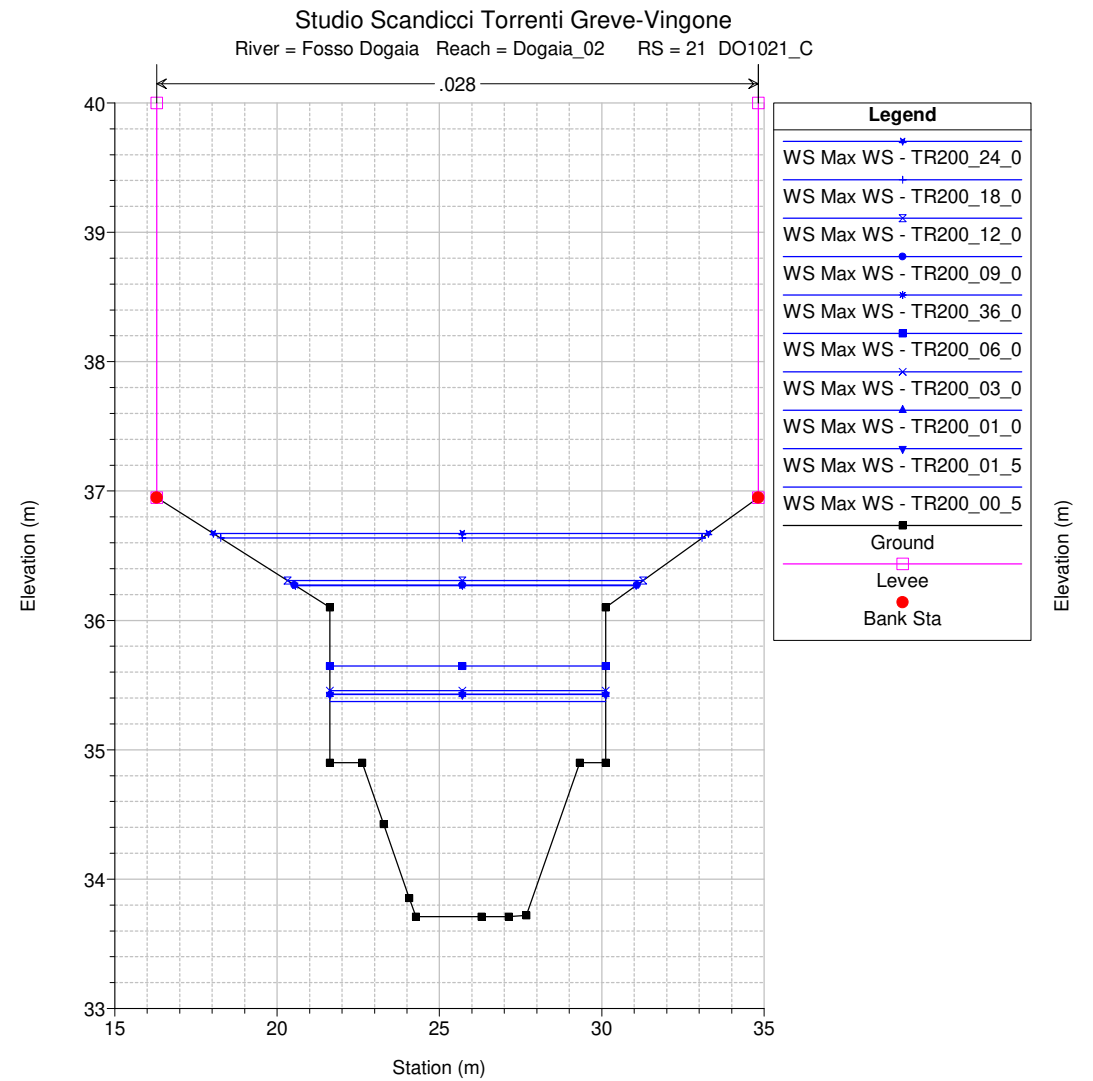
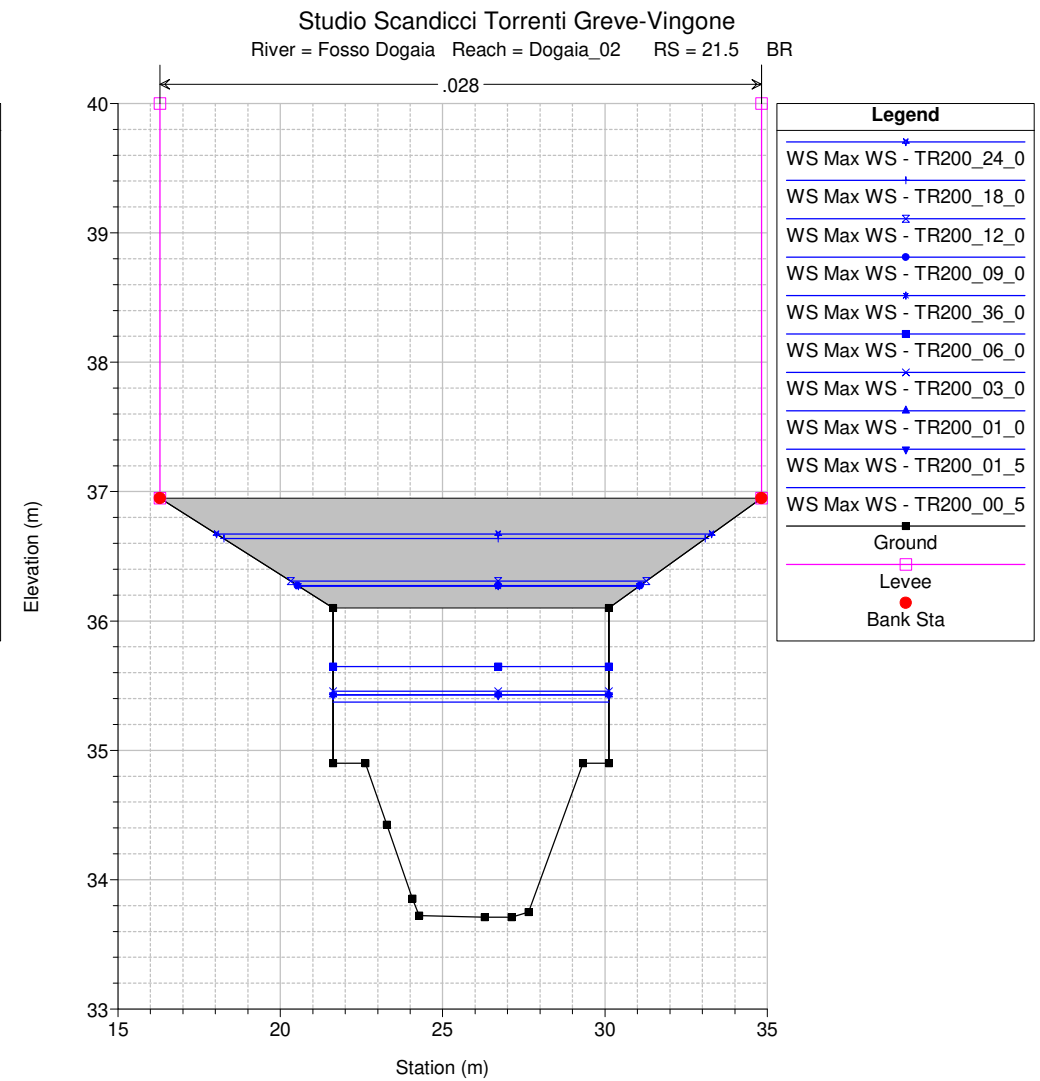
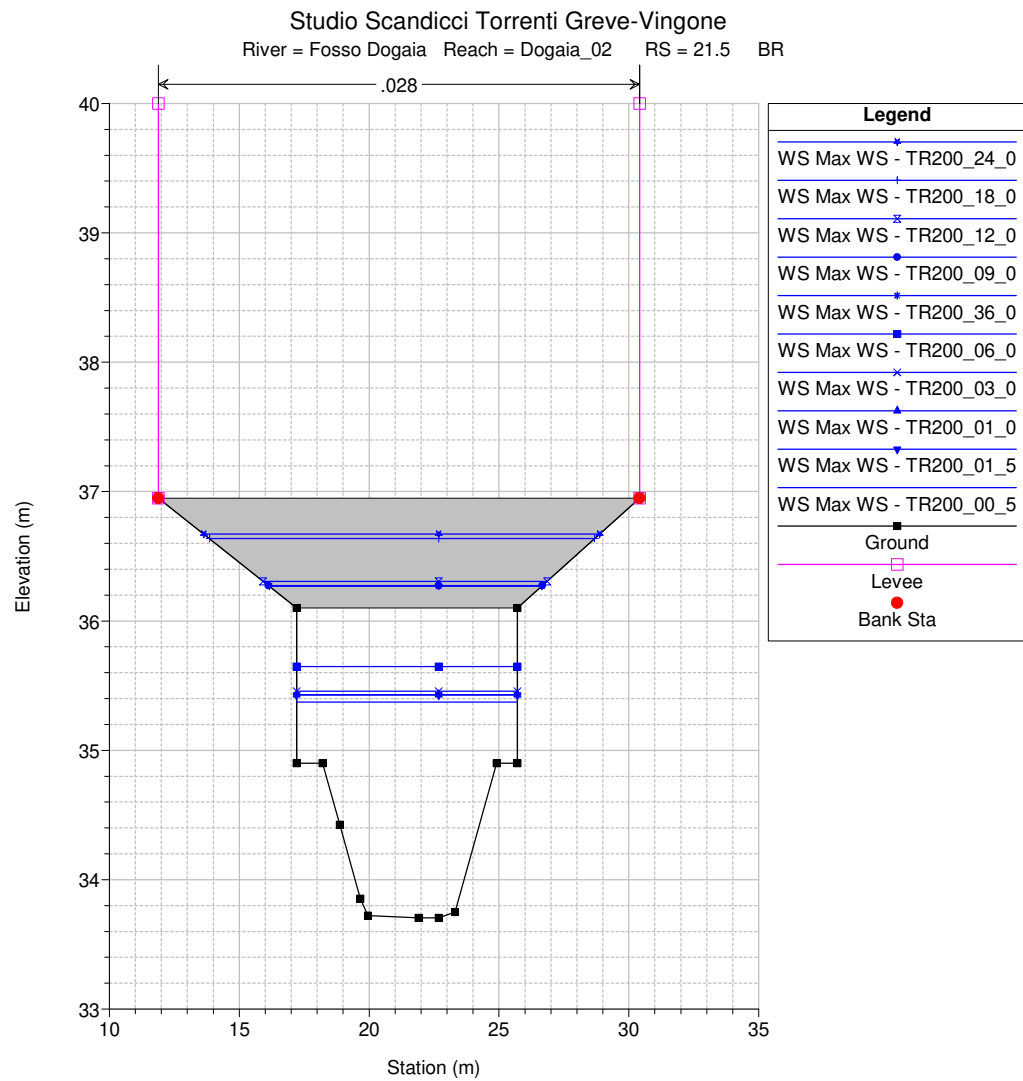
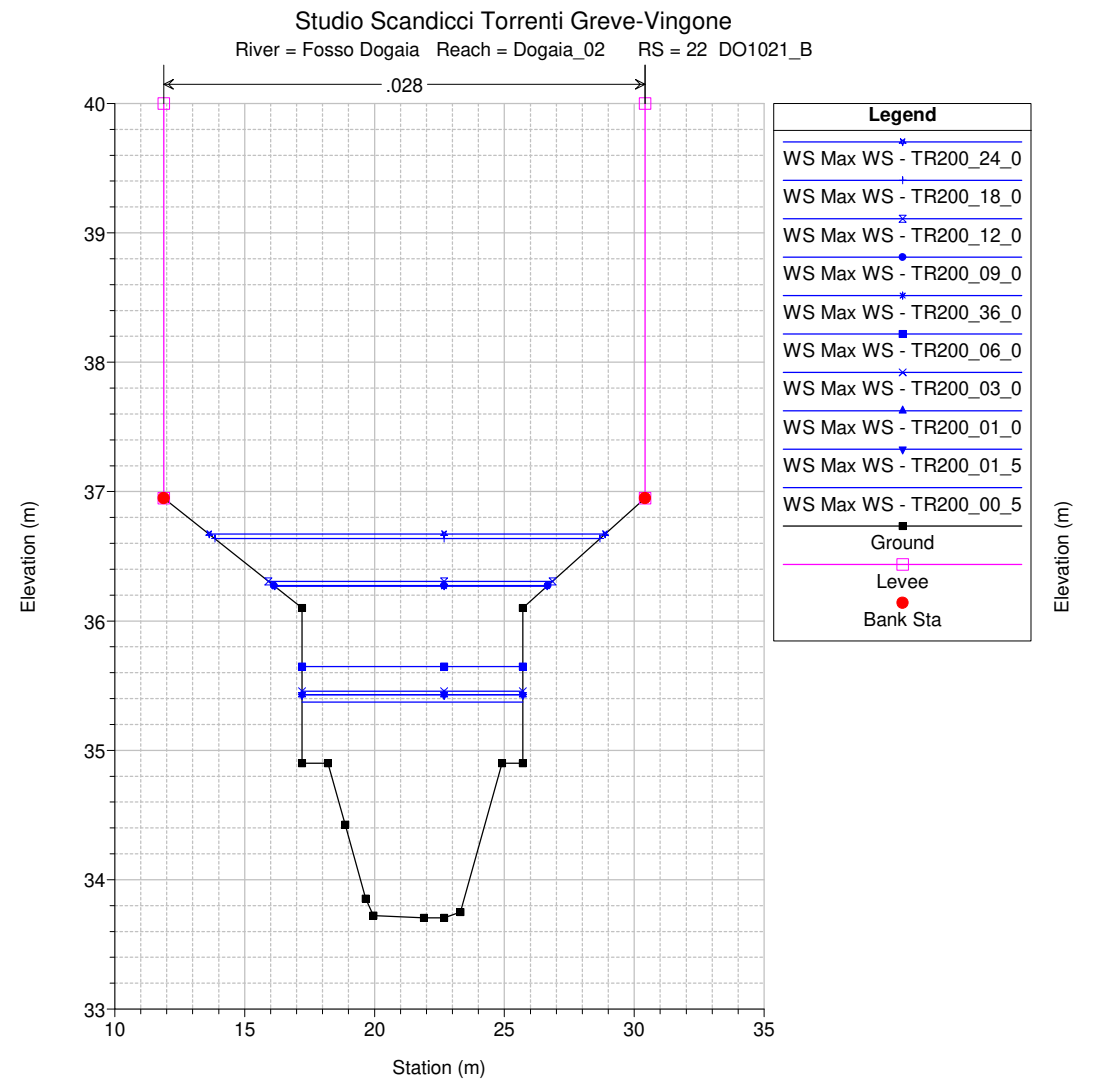

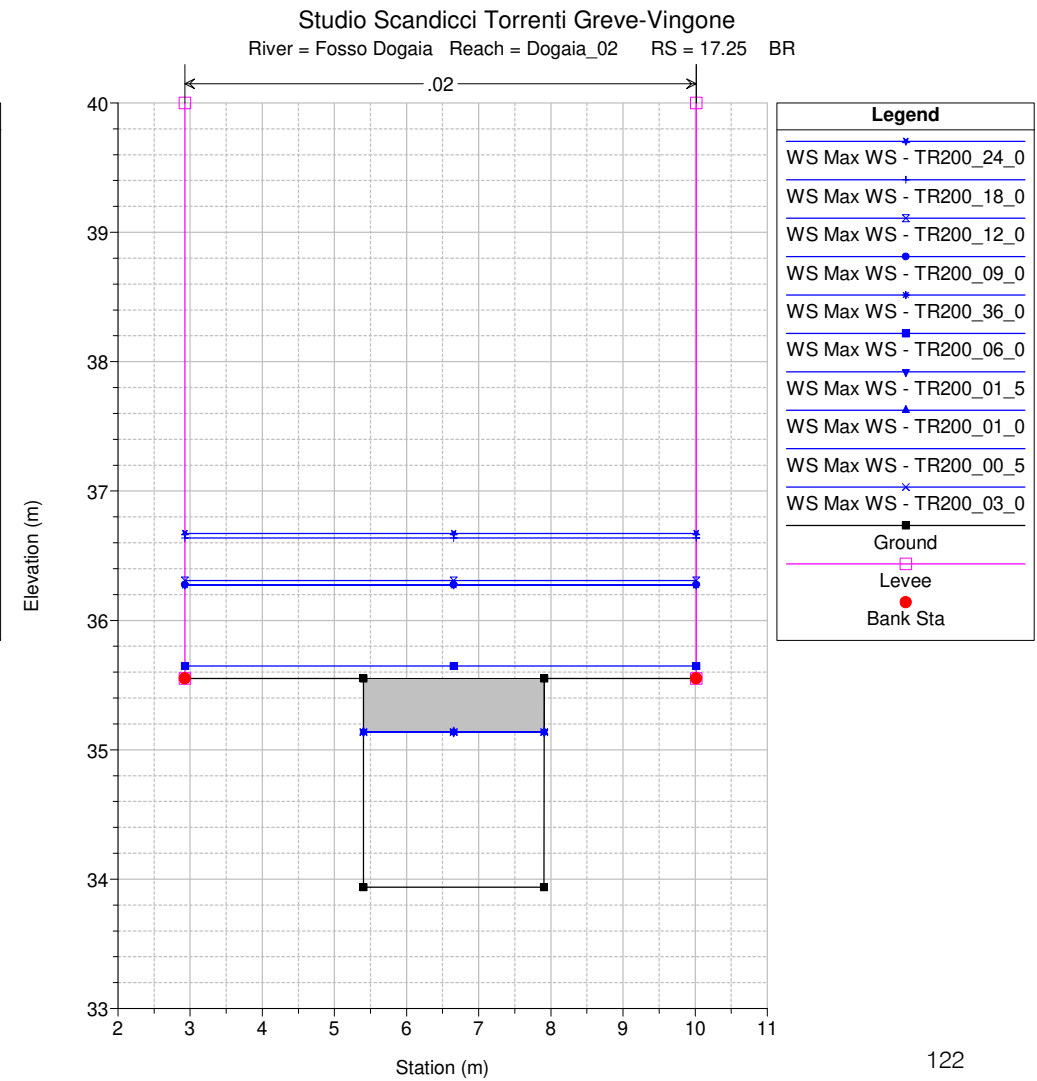
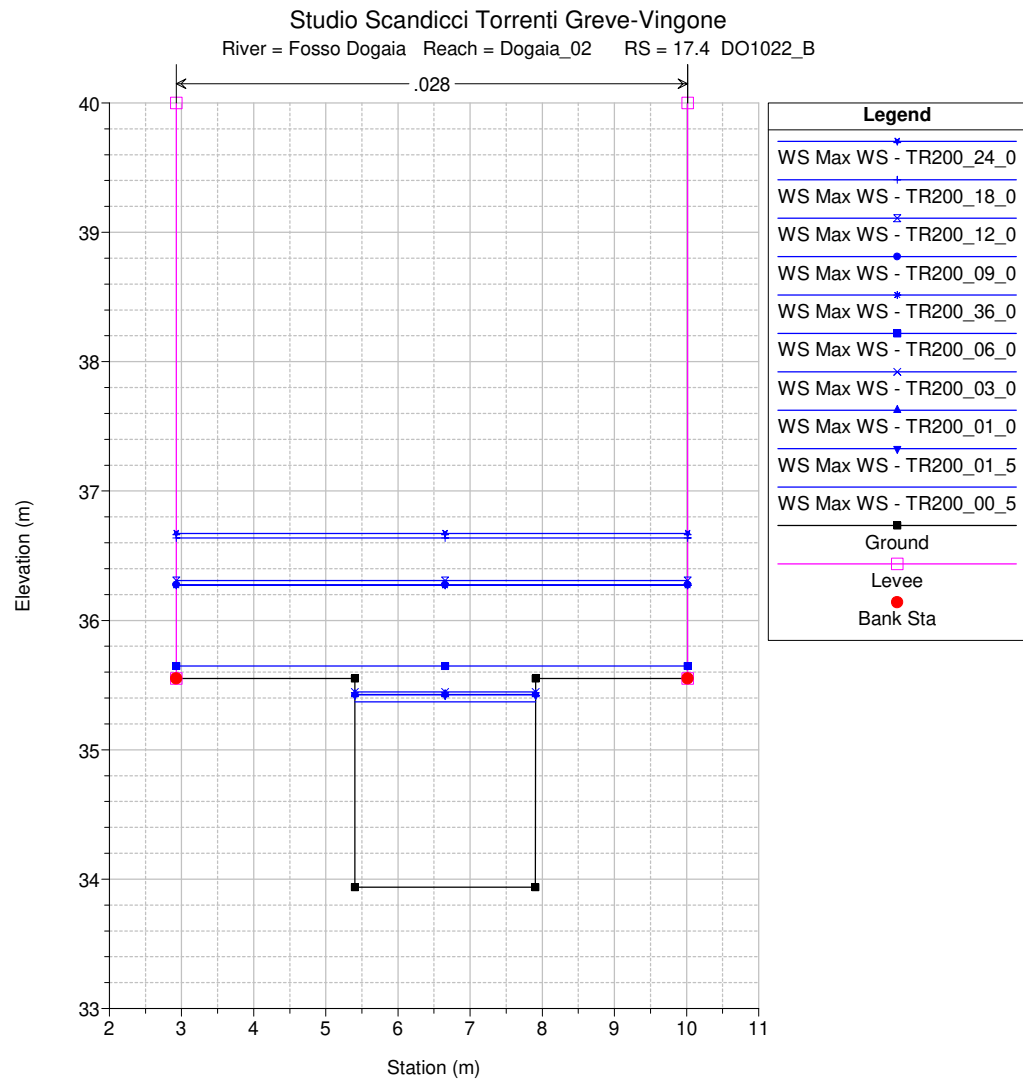
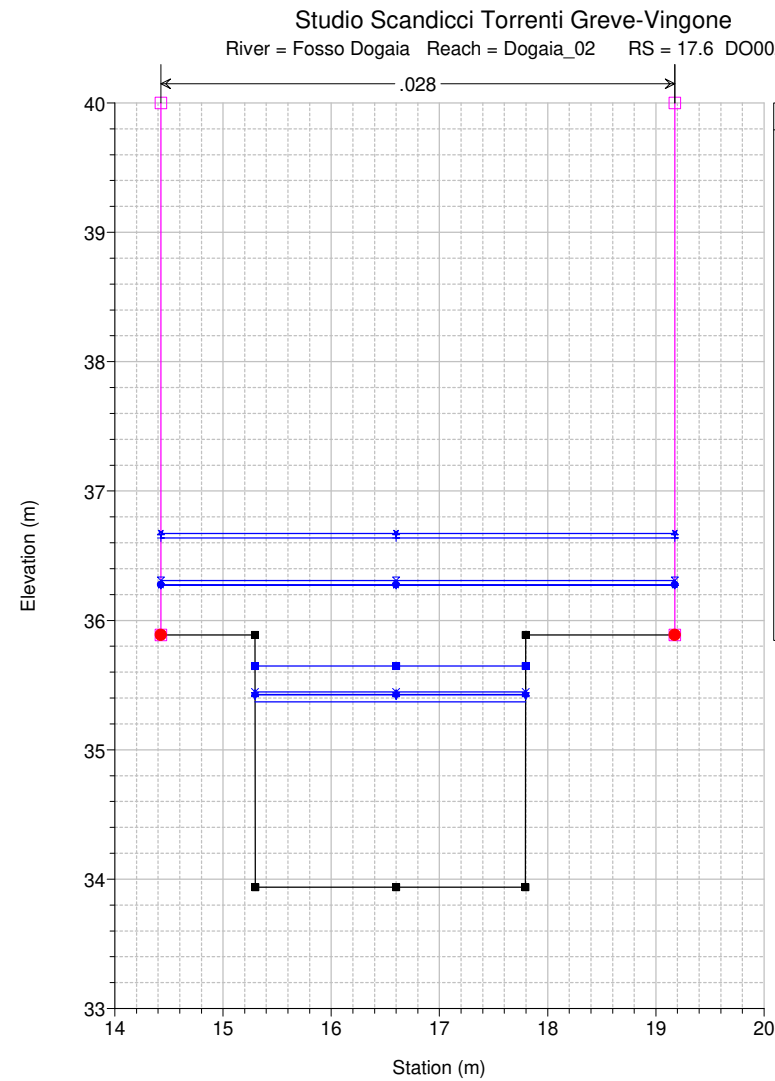
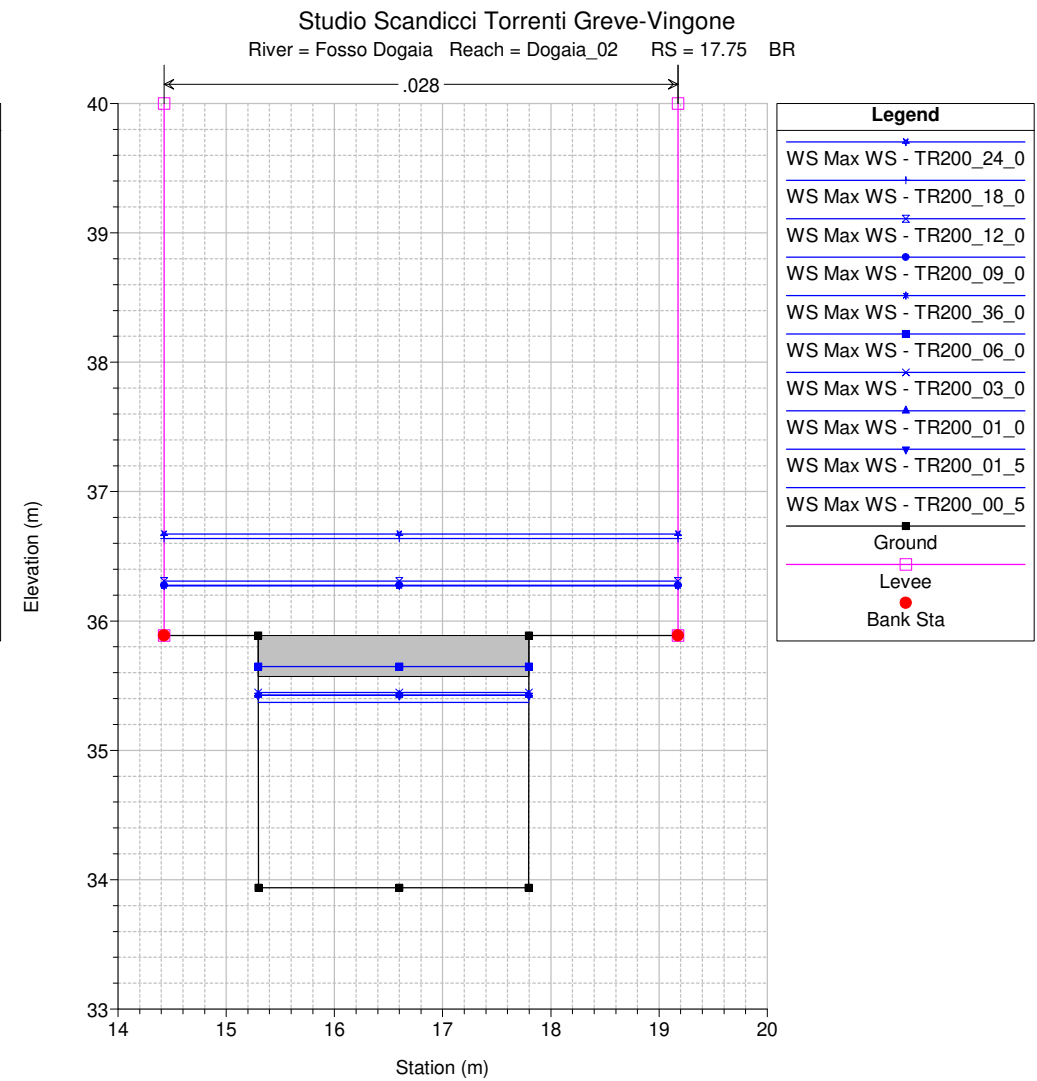
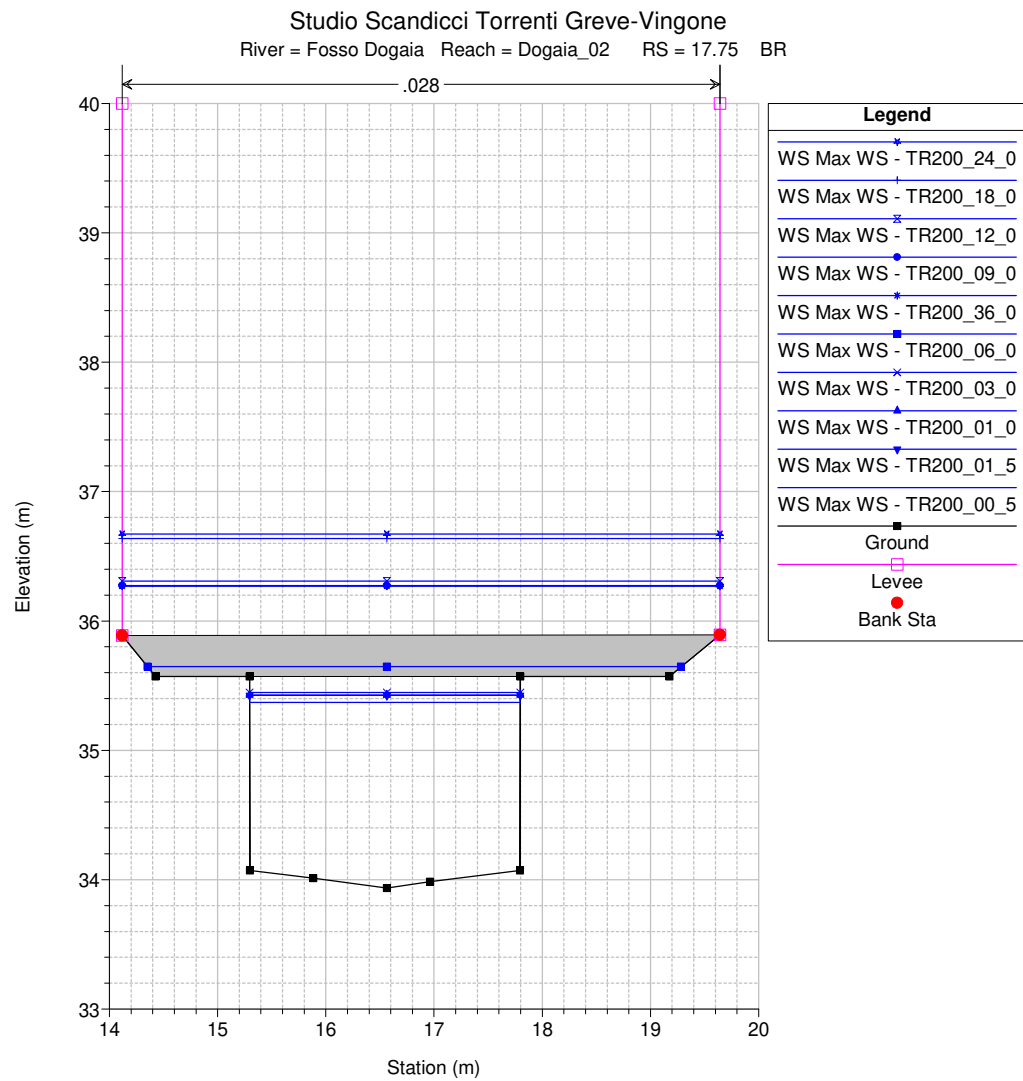
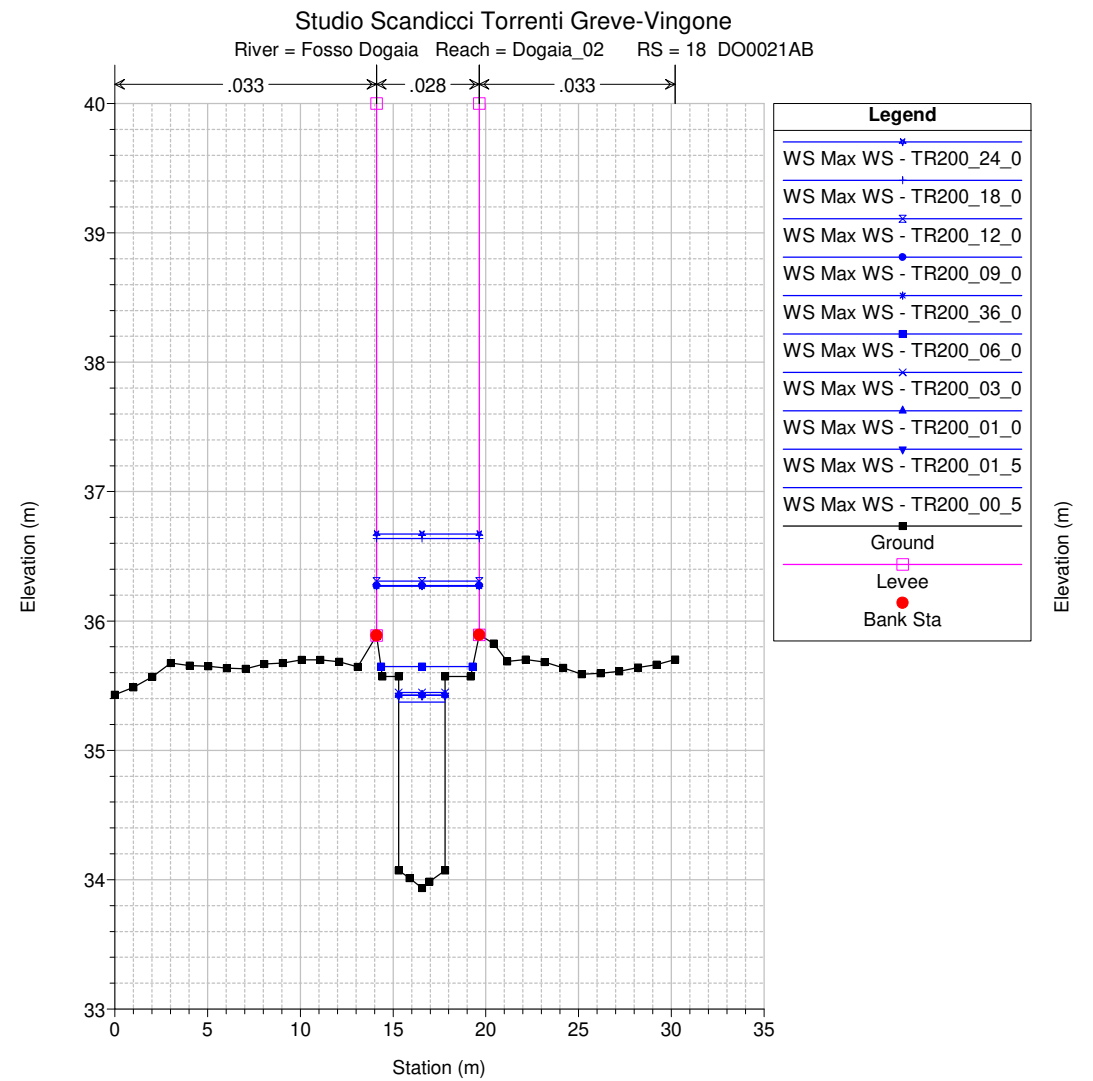

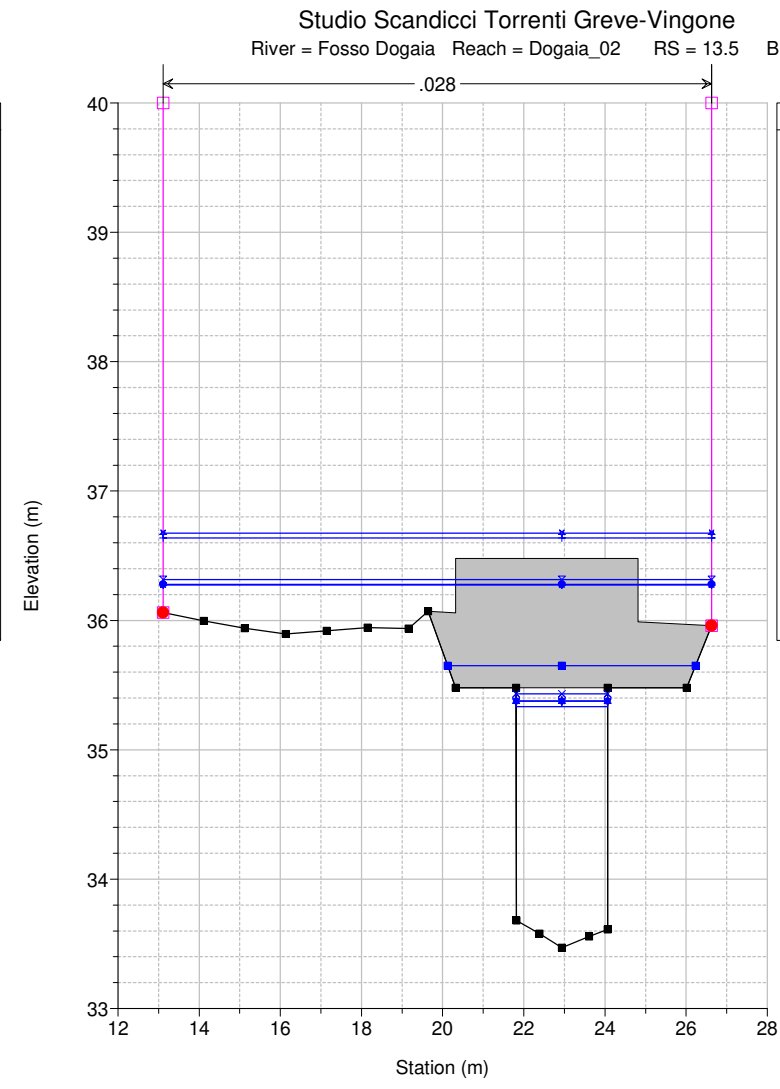
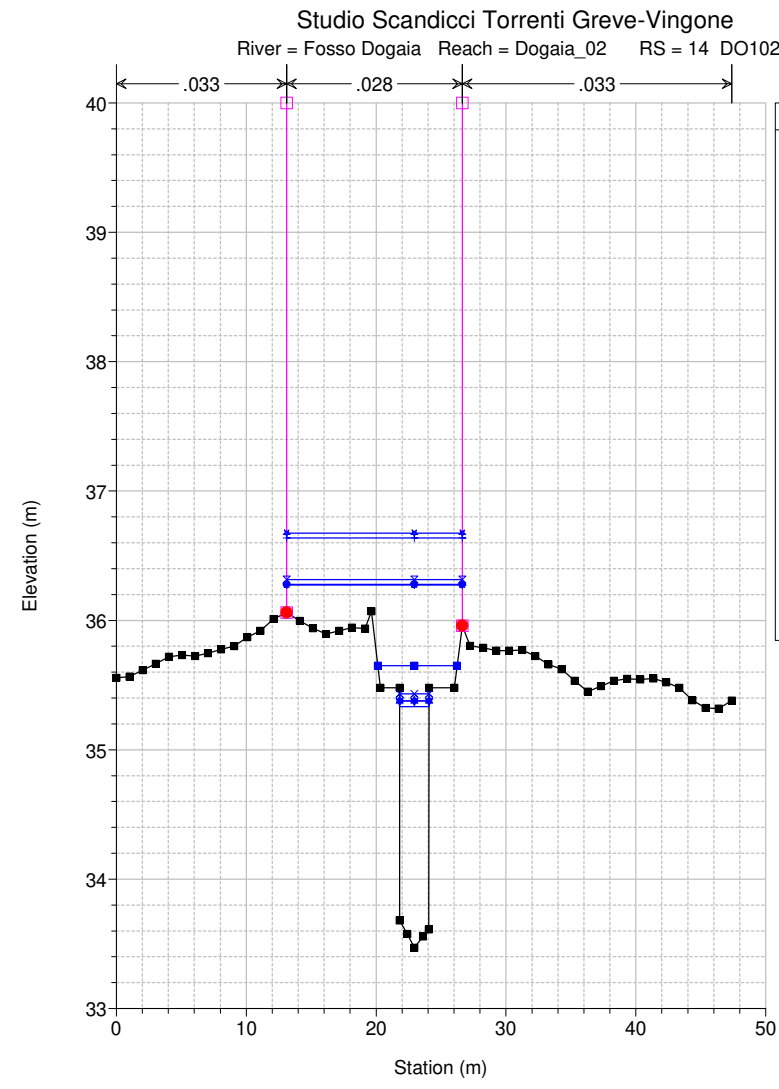
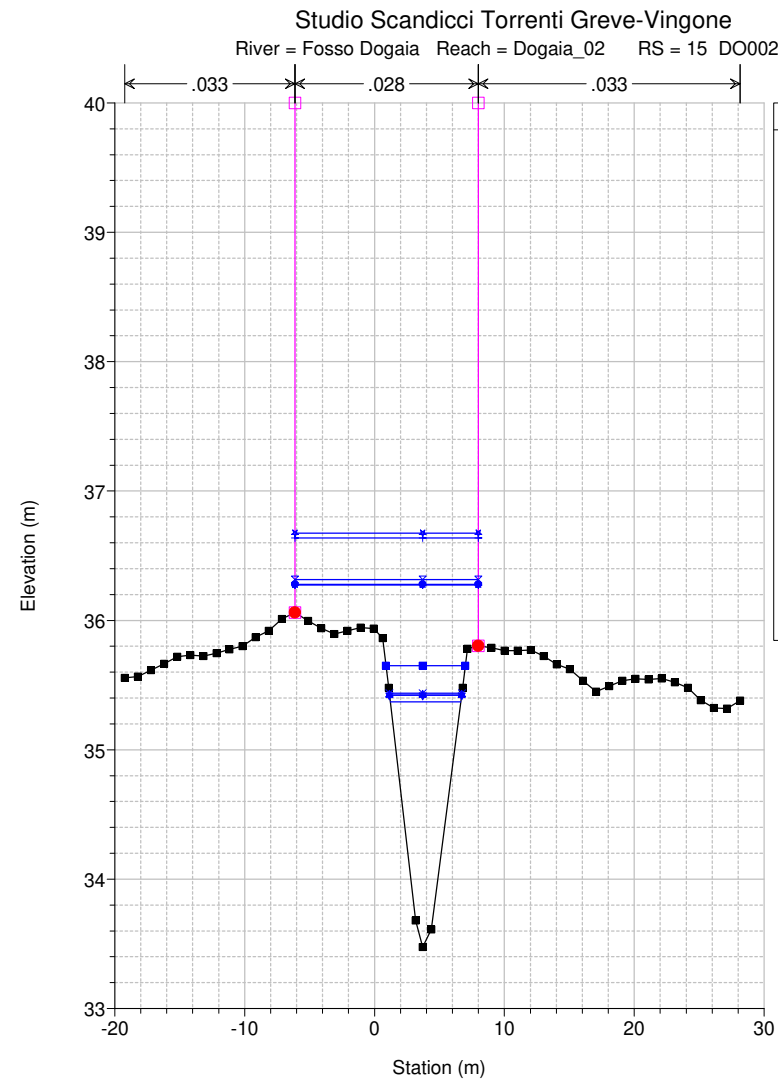
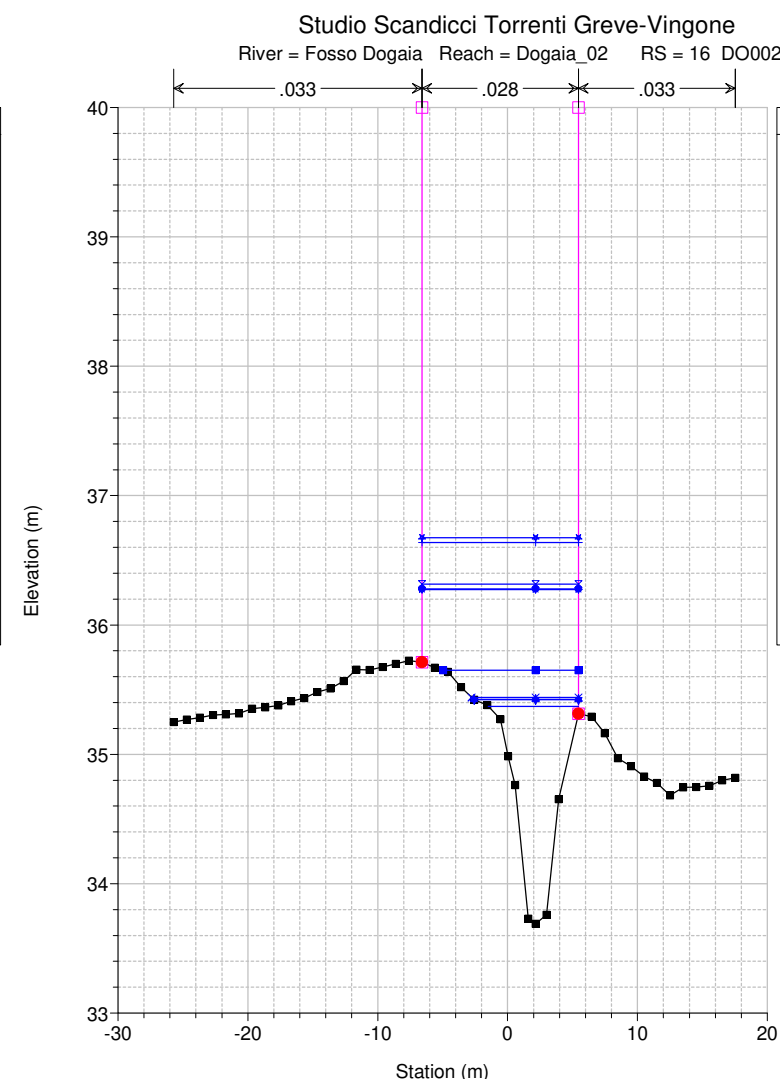
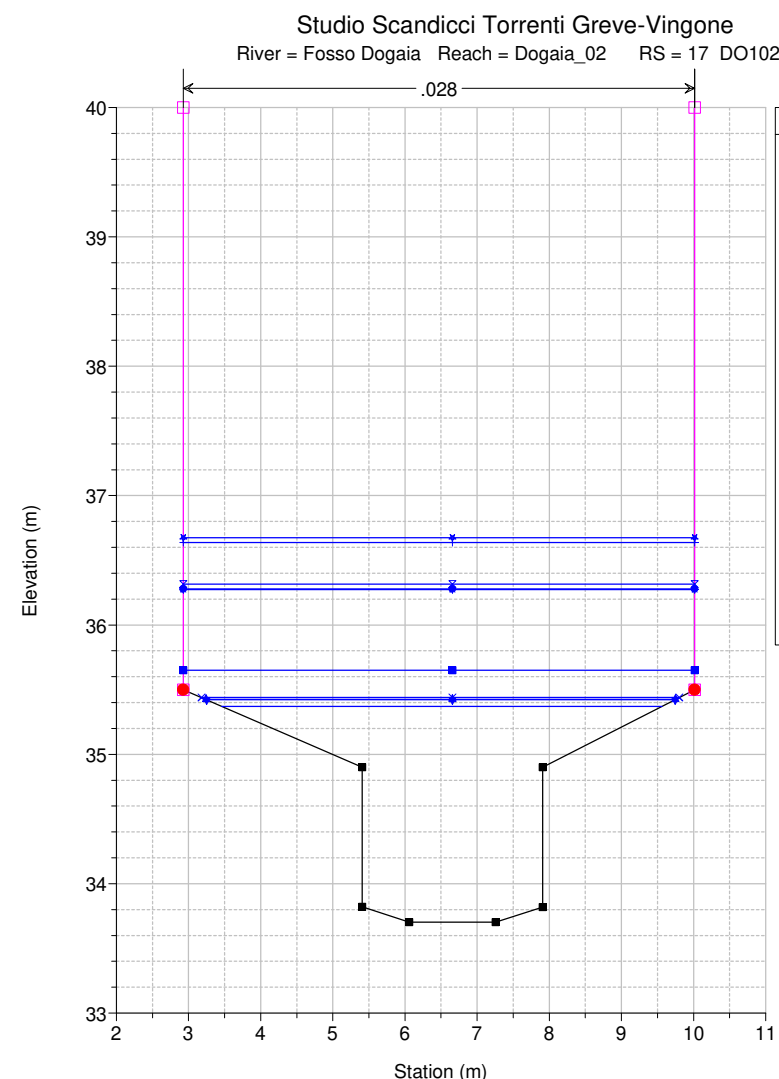
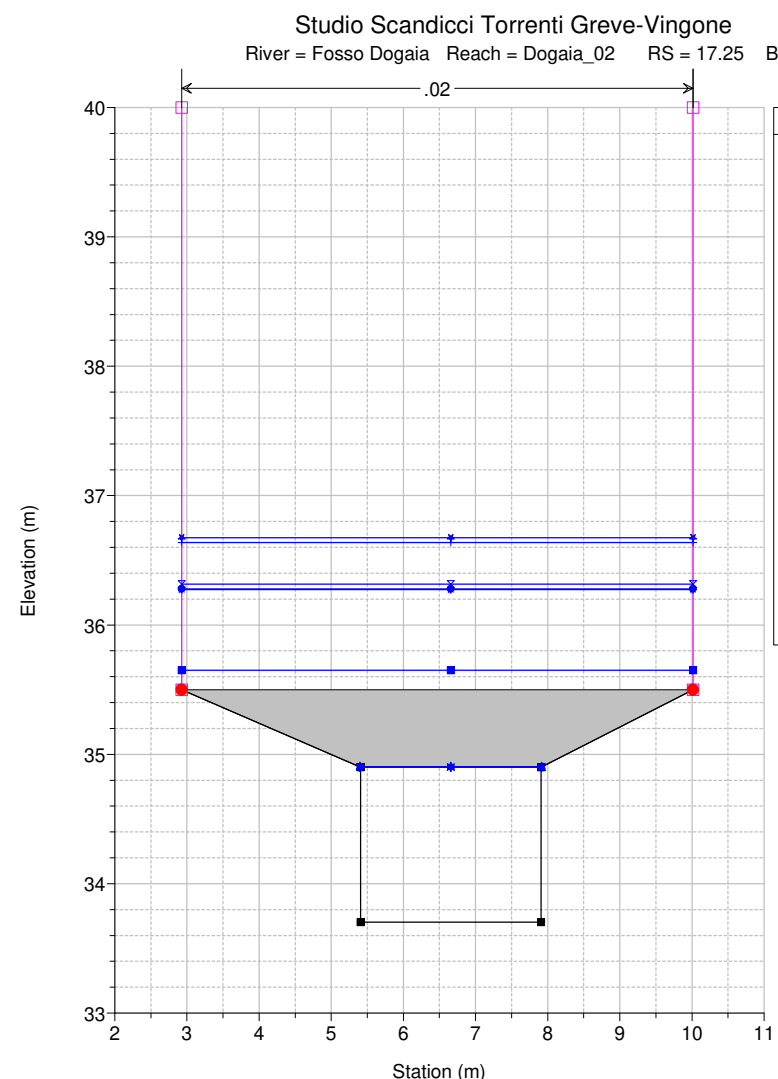

Studio Scandicci Torrenti Greve-Vingone
River = Fosso Dogaia Reach = Dogaia_02 RS = 13.5 BR

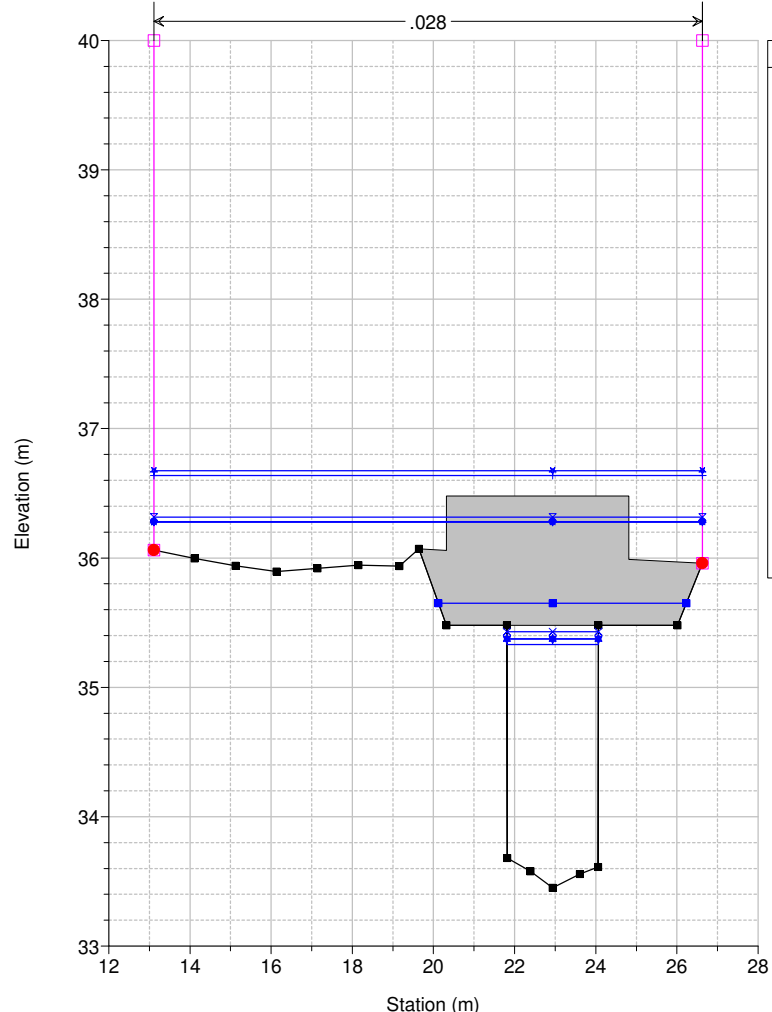

Legend	
WS Max WS - TR200_24_0	▲
WS Max WS - TR200_18_0	▲
WS Max WS - TR200_12_0	▲
WS Max WS - TR200_09_0	▲
WS Max WS - TR200_36_0	▲
WS Max WS - TR200_06_0	▲
WS Max WS - TR200_03_0	▲
WS Max WS - TR200_01_5	▲
WS Max WS - TR200_01_0	▲
WS Max WS - TR200_00_5	▲
Ground	■
Levee	□
Bank Sta	●

Studio Scandicci Torrenti Greve-Vingone
River = Fosso Dogaia Reach = Dogaia_02 RS = 13 DO1023_C

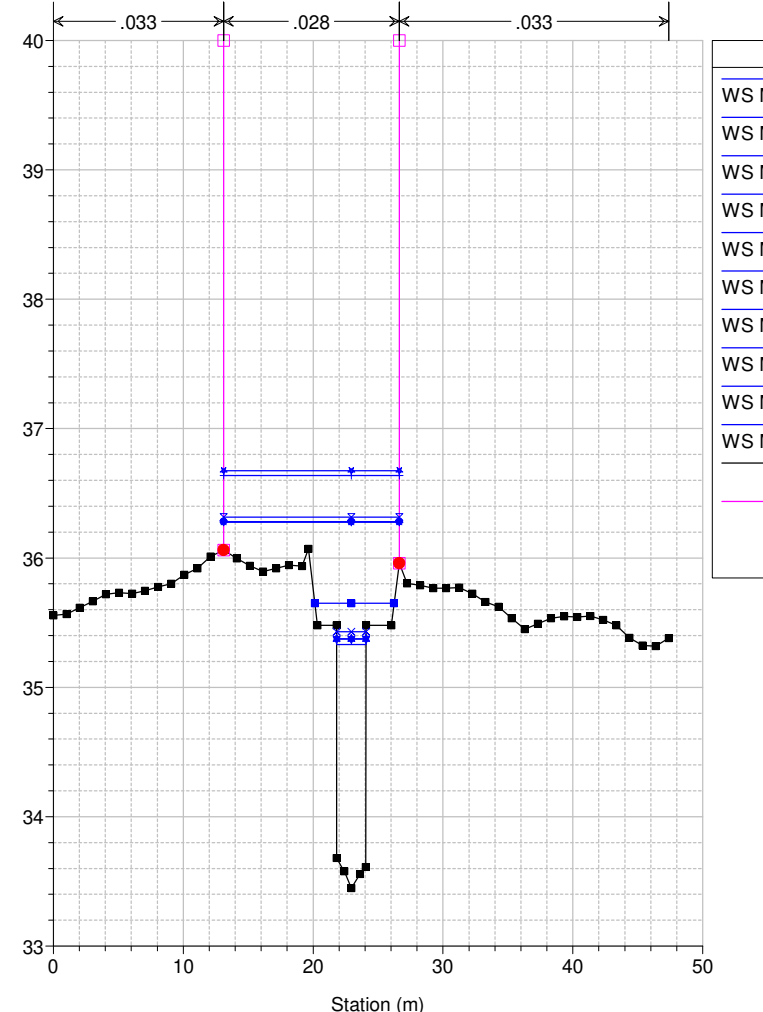

Legend	
WS Max WS - TR200_24_0	▲
WS Max WS - TR200_18_0	▲
WS Max WS - TR200_12_0	▲
WS Max WS - TR200_09_0	▲
WS Max WS - TR200_36_0	▲
WS Max WS - TR200_06_0	▲
WS Max WS - TR200_03_0	▲
WS Max WS - TR200_01_5	▲
WS Max WS - TR200_01_0	▲
WS Max WS - TR200_00_5	▲
Ground	■
Levee	□
Bank Sta	●

Studio Scandicci Torrenti Greve-Vingone
River = Fosso Dogaia Reach = Dogaia_02 RS = 12 DO0023_D

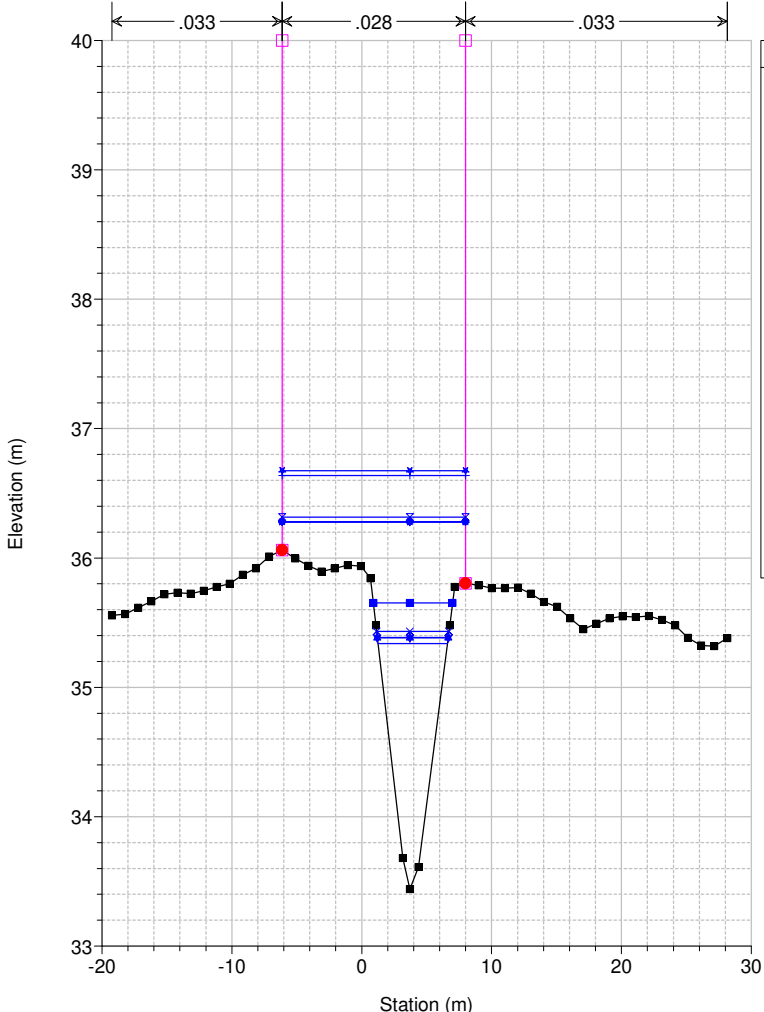

Legend	
WS Max WS - TR200_24_0	▲
WS Max WS - TR200_18_0	▲
WS Max WS - TR200_12_0	▲
WS Max WS - TR200_09_0	▲
WS Max WS - TR200_36_0	▲
WS Max WS - TR200_06_0	▲
WS Max WS - TR200_03_0	▲
WS Max WS - TR200_01_5	▲
WS Max WS - TR200_01_0	▲
WS Max WS - TR200_00_5	▲
Ground	■
Levee	□
Bank Sta	●

Studio Scandicci Torrenti Greve-Vingone
River = Fosso Dogaia Reach = Dogaia_02 RS = 11 DO0024_A

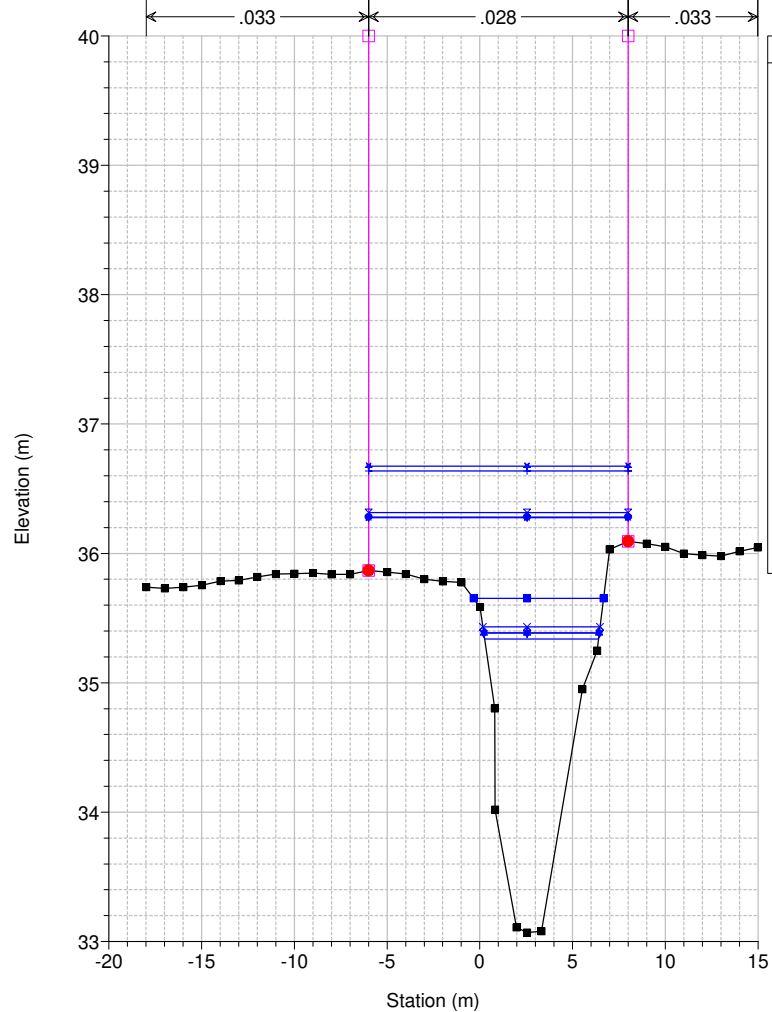

Legend	
WS Max WS - TR200_24_0	▲
WS Max WS - TR200_18_0	▲
WS Max WS - TR200_12_0	▲
WS Max WS - TR200_09_0	▲
WS Max WS - TR200_36_0	▲
WS Max WS - TR200_06_0	▲
WS Max WS - TR200_03_0	▲
WS Max WS - TR200_01_5	▲
WS Max WS - TR200_01_0	▲
WS Max WS - TR200_00_5	▲
Ground	■
Levee	□
Bank Sta	●

Studio Scandicci Torrenti Greve-Vingone
River = Fosso Dogaia Reach = Dogaia_02 RS = 10 DO0024_B

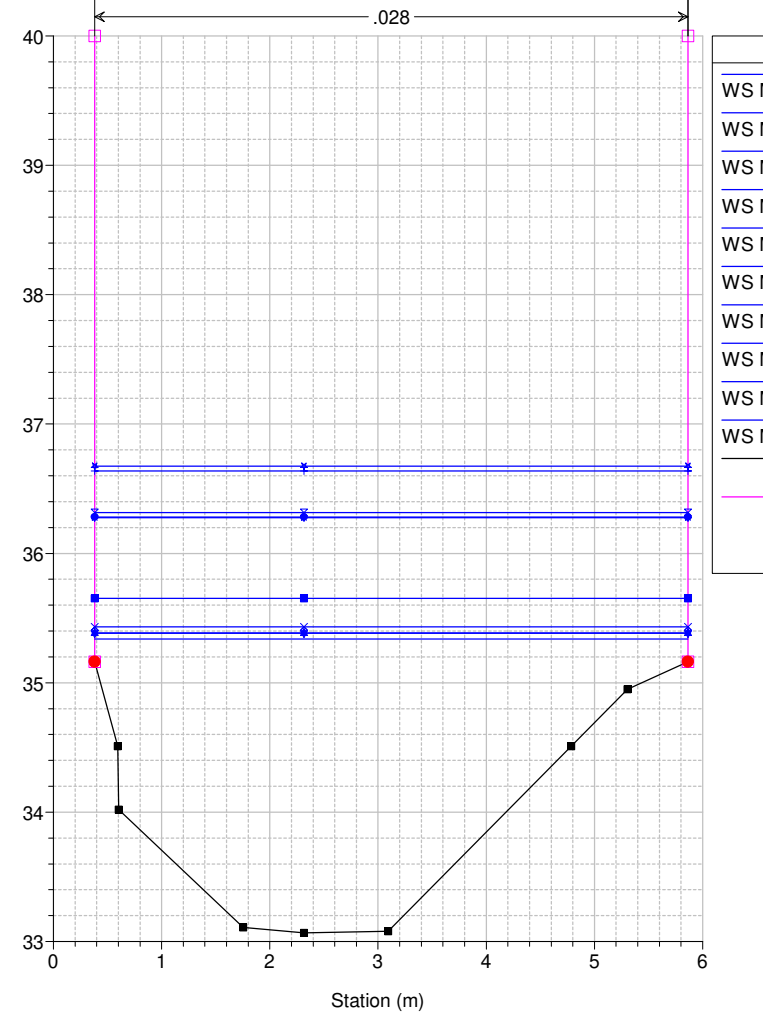

Legend	
WS Max WS - TR200_24_0	▲
WS Max WS - TR200_18_0	▲
WS Max WS - TR200_12_0	▲
WS Max WS - TR200_09_0	▲
WS Max WS - TR200_36_0	▲
WS Max WS - TR200_06_0	▲
WS Max WS - TR200_03_0	▲
WS Max WS - TR200_01_5	▲
WS Max WS - TR200_01_0	▲
WS Max WS - TR200_00_5	▲
Ground	■
Levee	□
Bank Sta	●

Studio Scandicci Torrenti Greve-Vingone
River = Fosso Dogaia Reach = Dogaia_02 RS = 9.5 BR

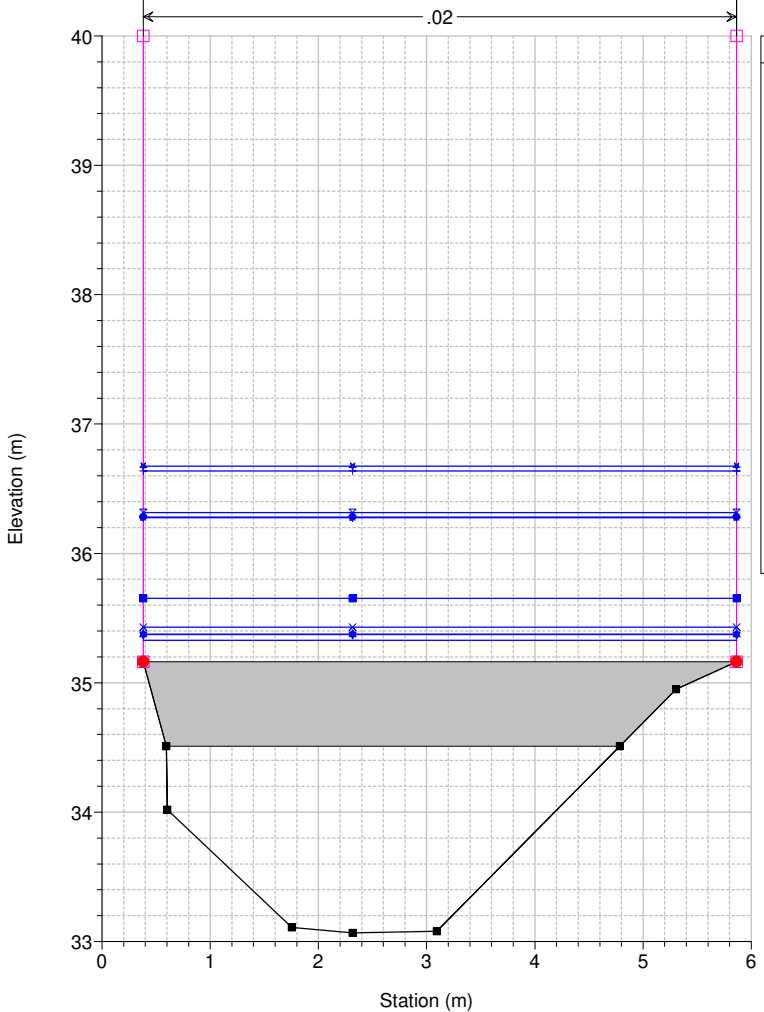

Legend	
WS Max WS - TR200_24_0	▲
WS Max WS - TR200_18_0	▲
WS Max WS - TR200_12_0	▲
WS Max WS - TR200_09_0	▲
WS Max WS - TR200_36_0	▲
WS Max WS - TR200_06_0	▲
WS Max WS - TR200_03_0	▲
WS Max WS - TR200_01_5	▲
WS Max WS - TR200_01_0	▲
WS Max WS - TR200_00_5	▲
Ground	■
Levee	□
Bank Sta	●

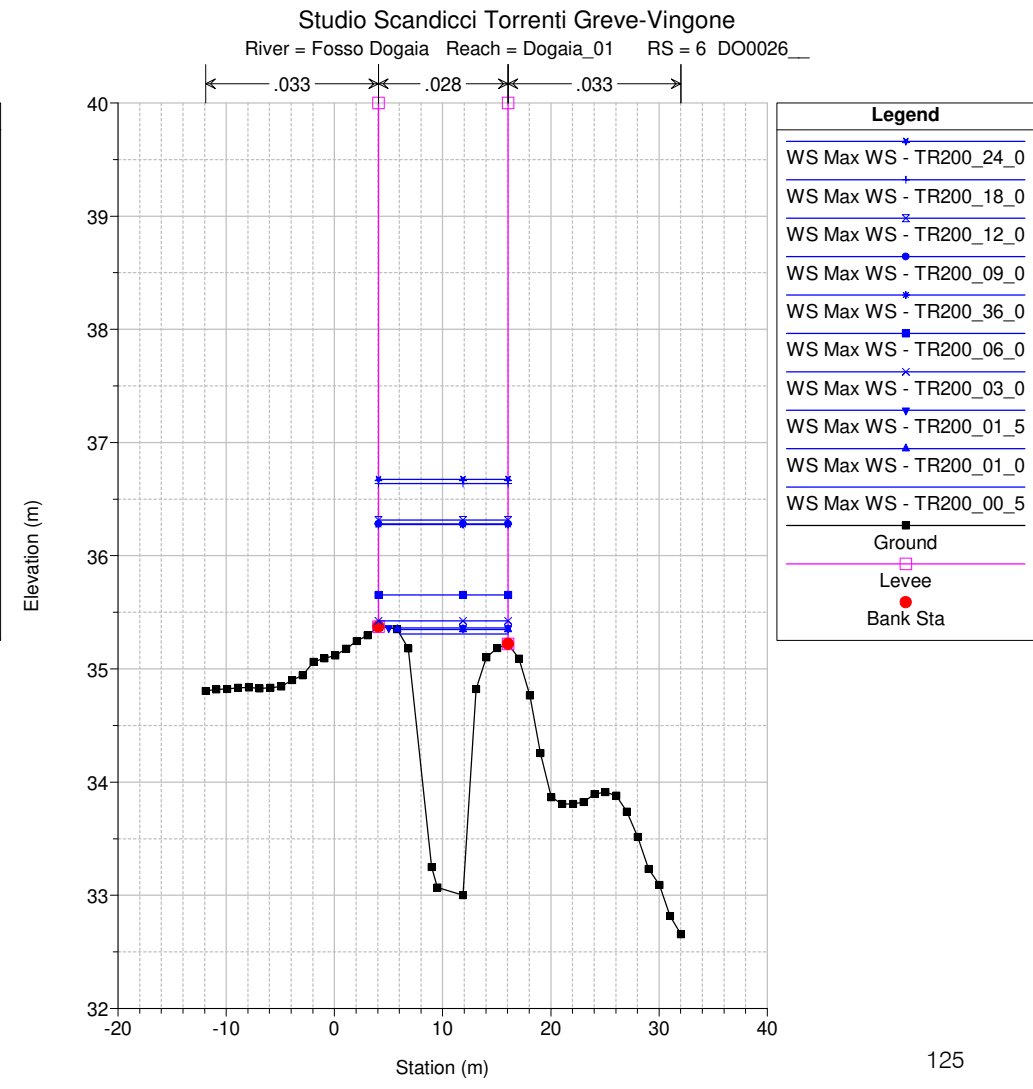
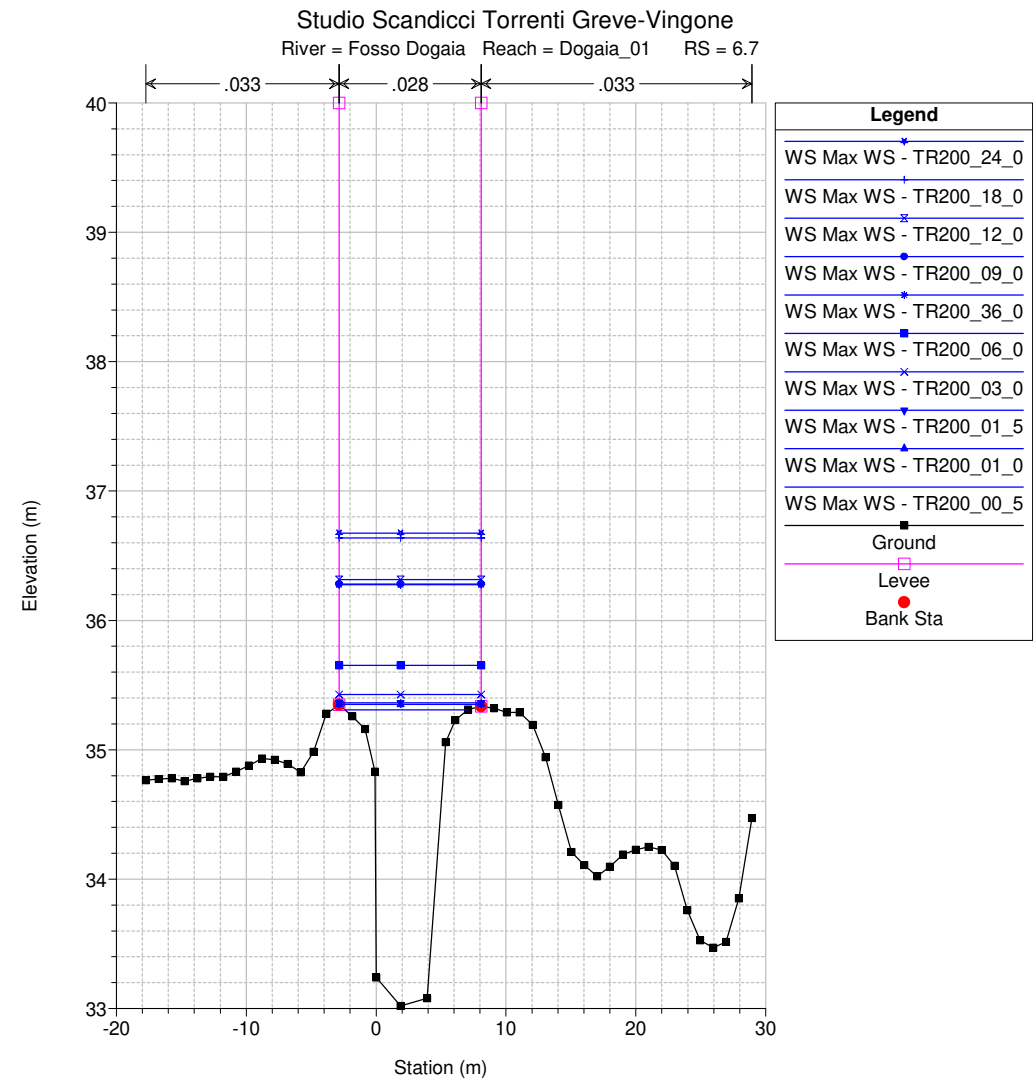
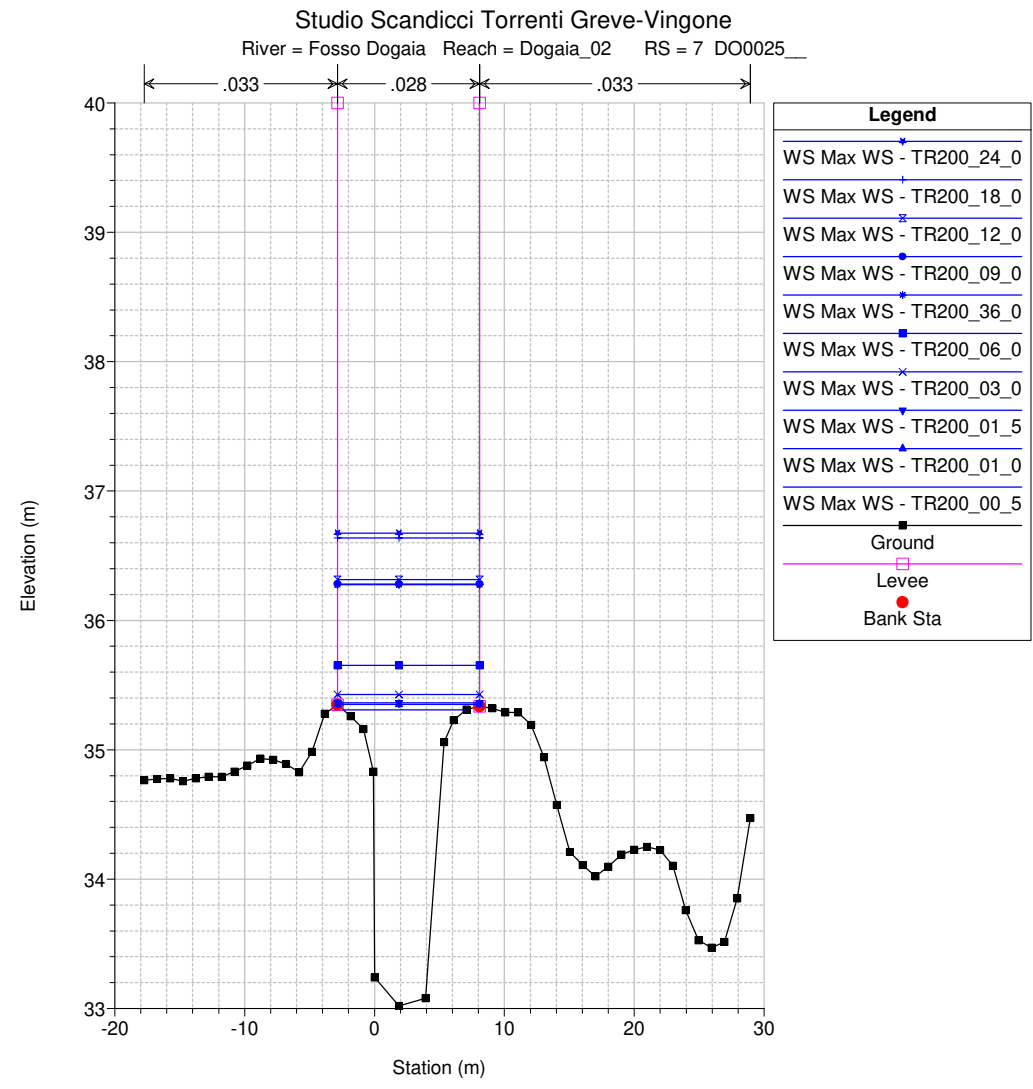
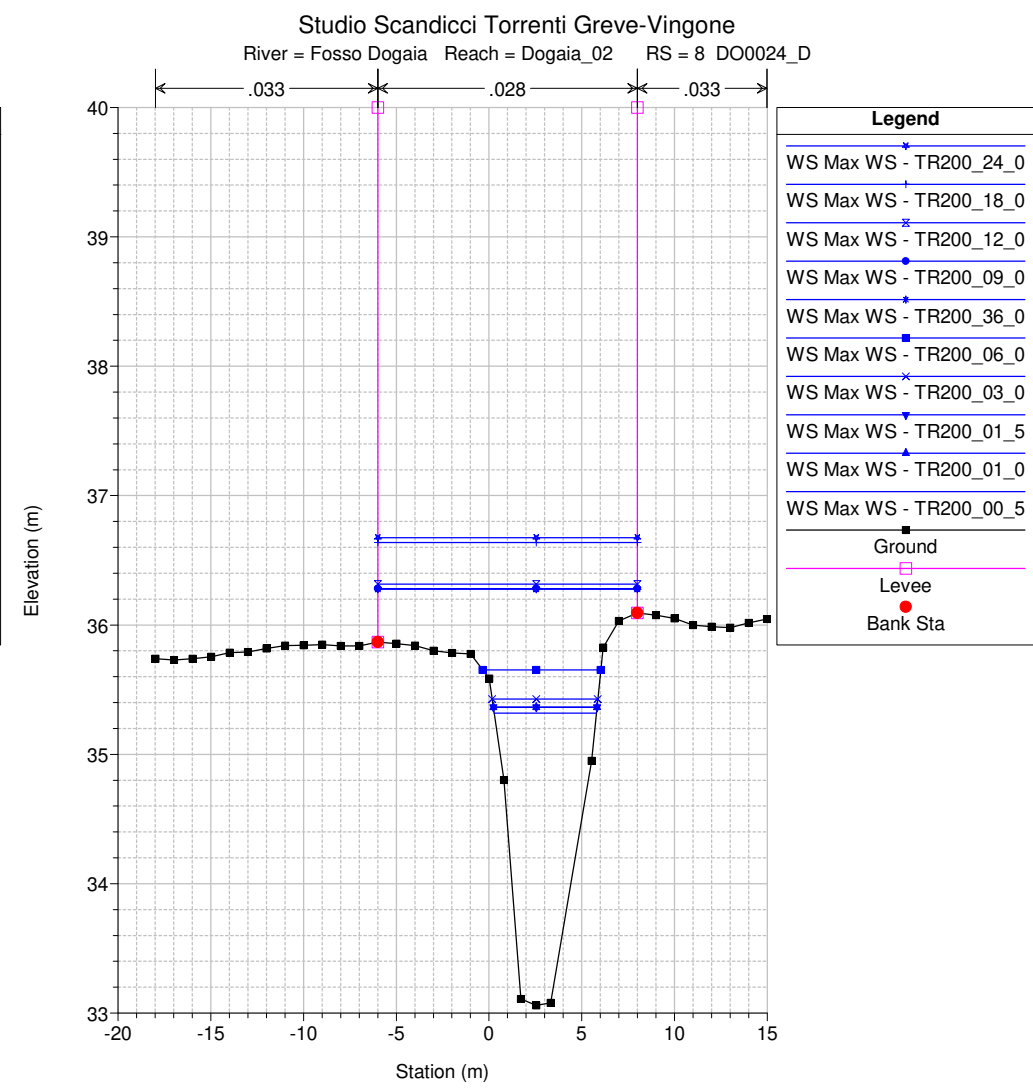
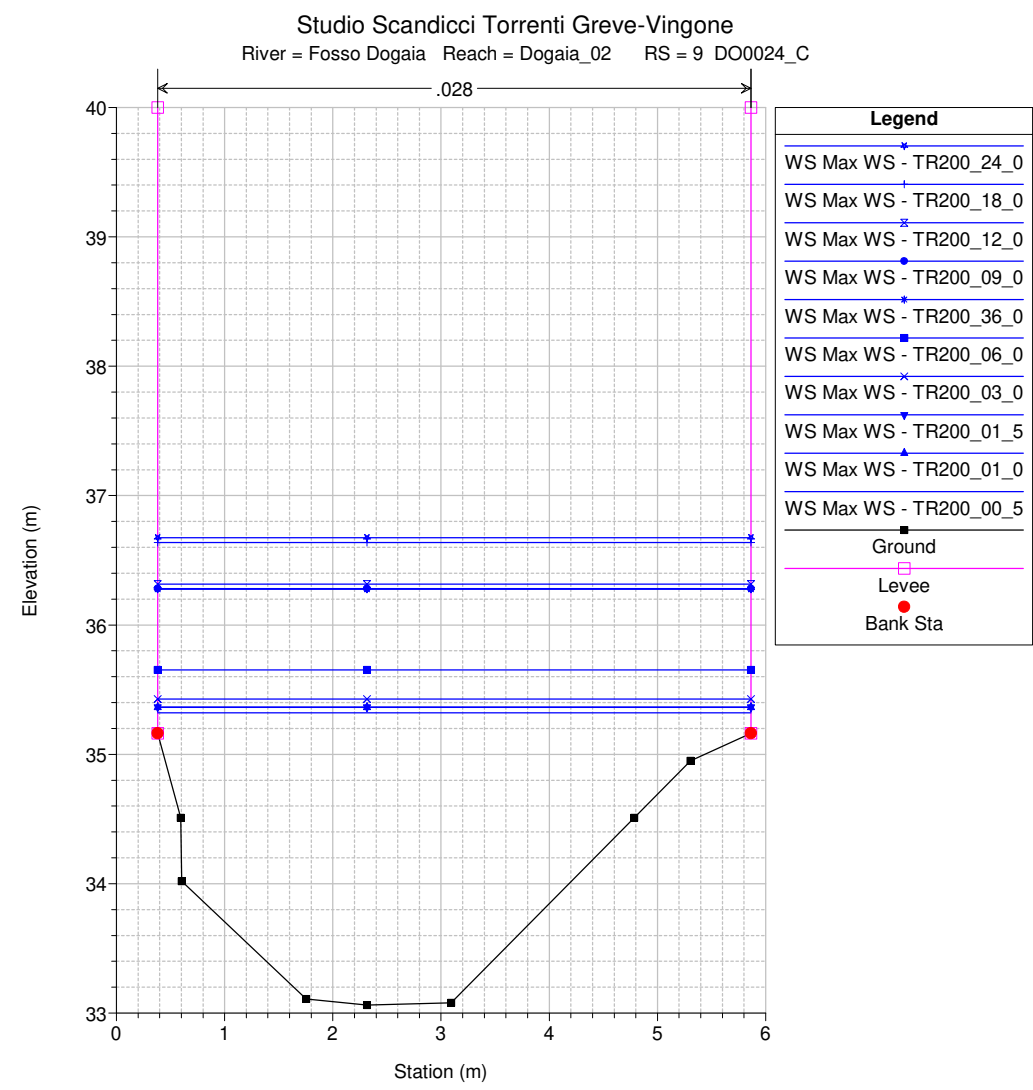
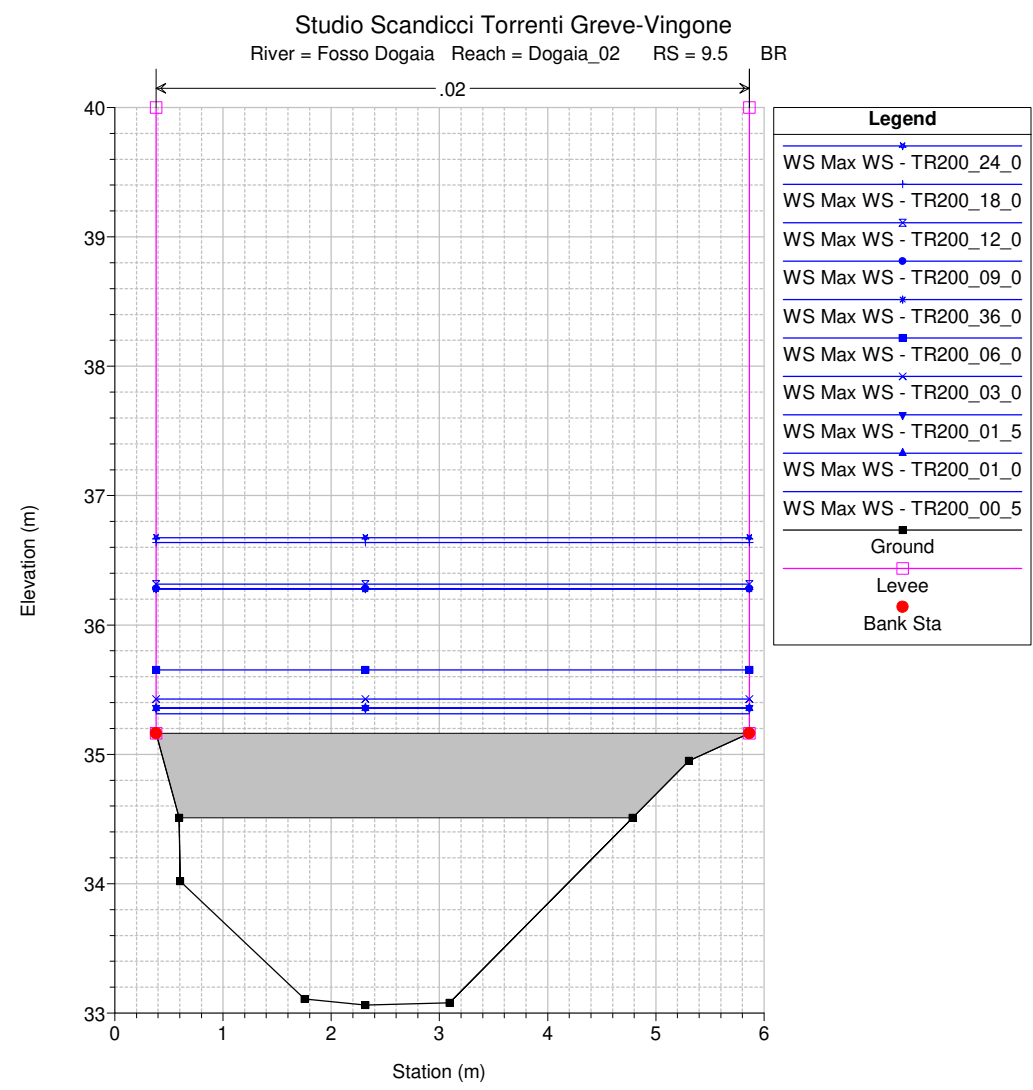

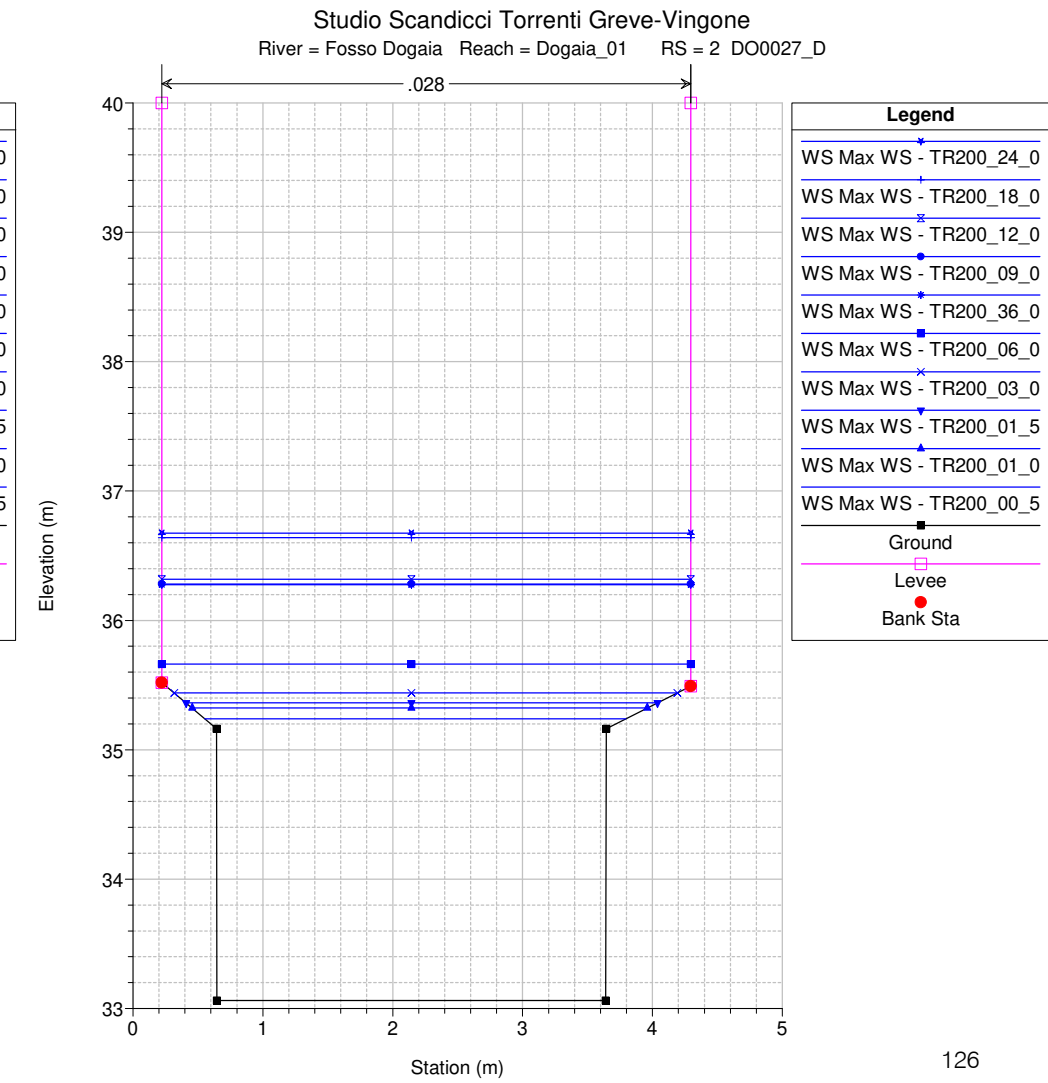
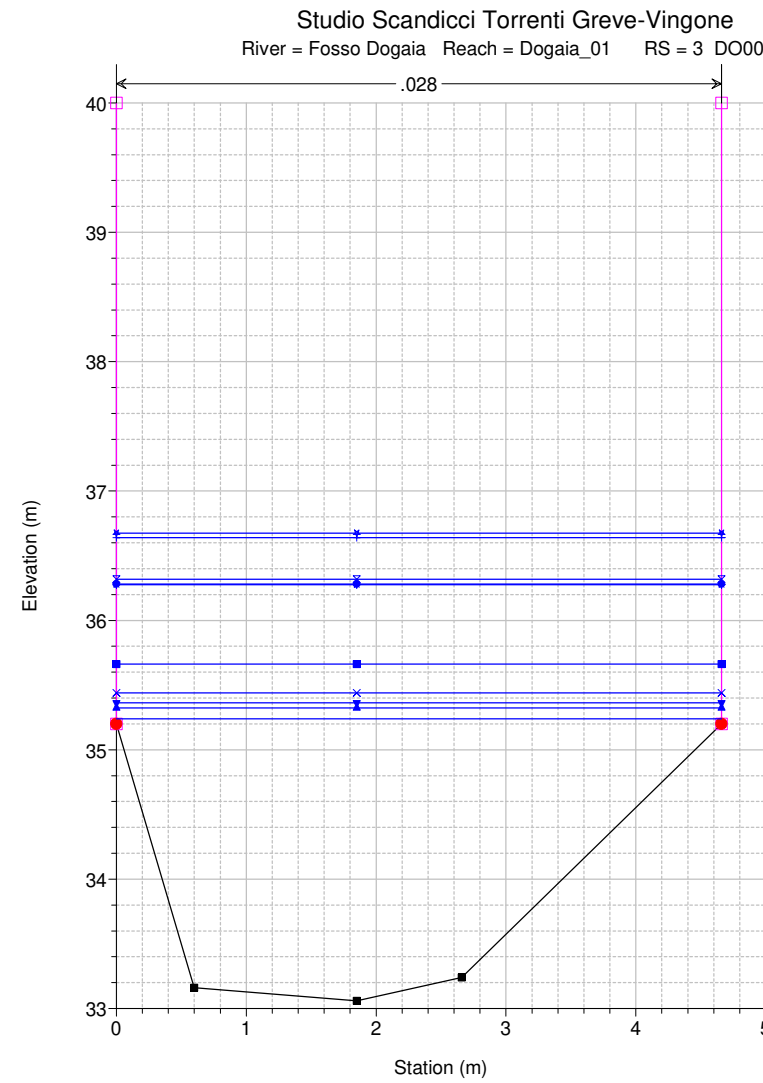
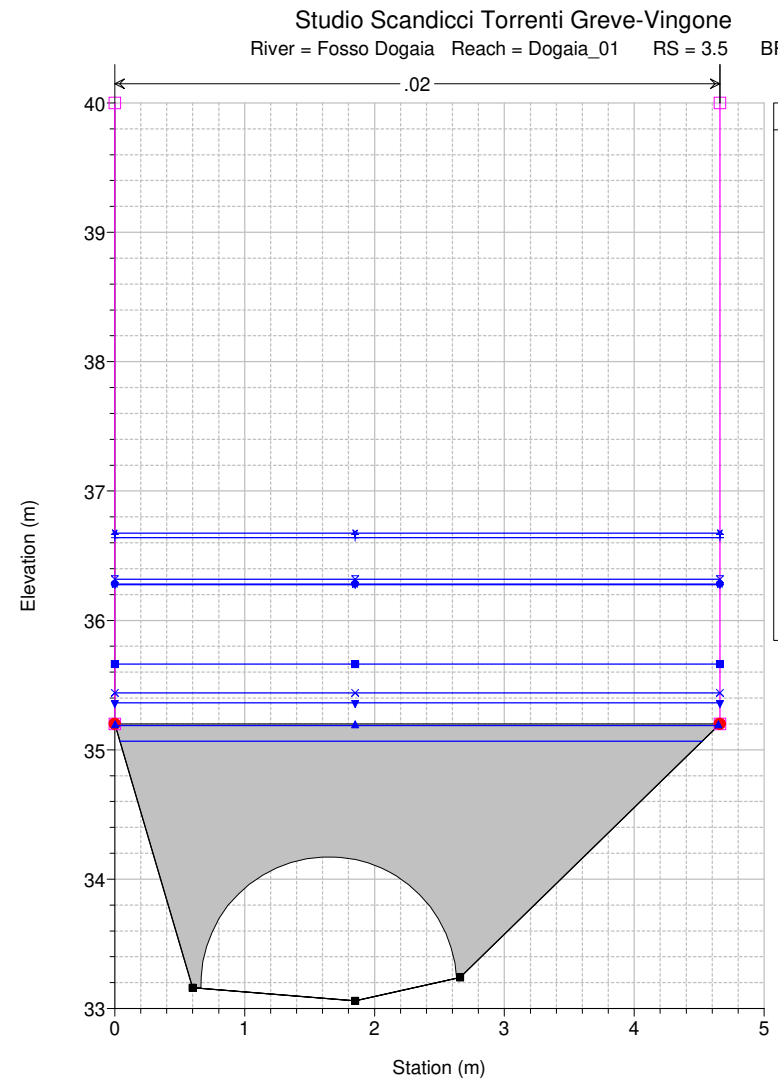
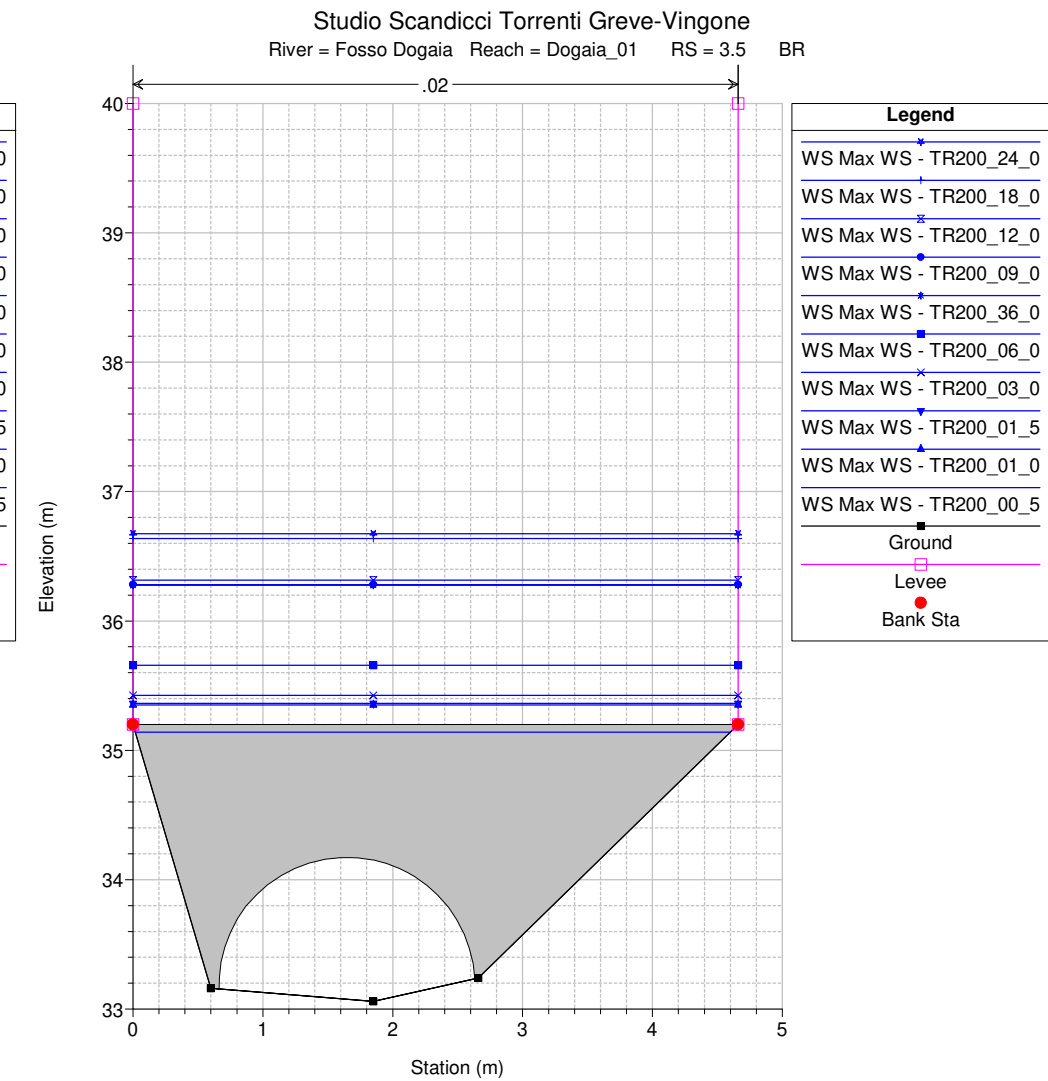
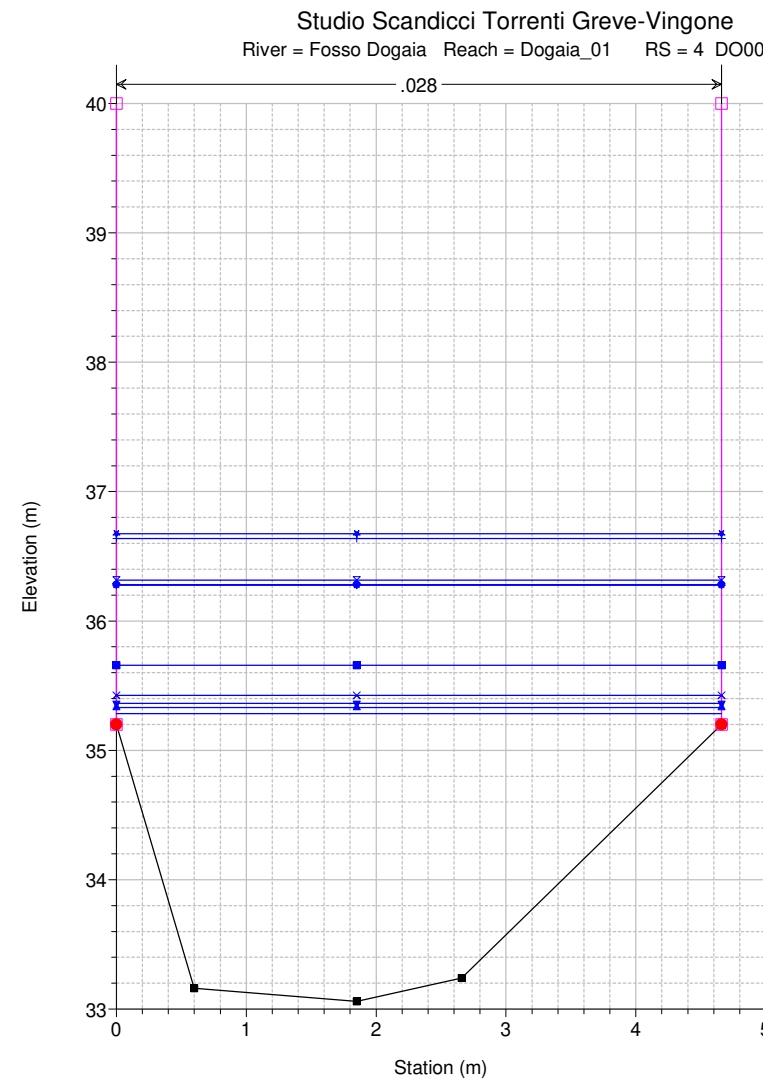
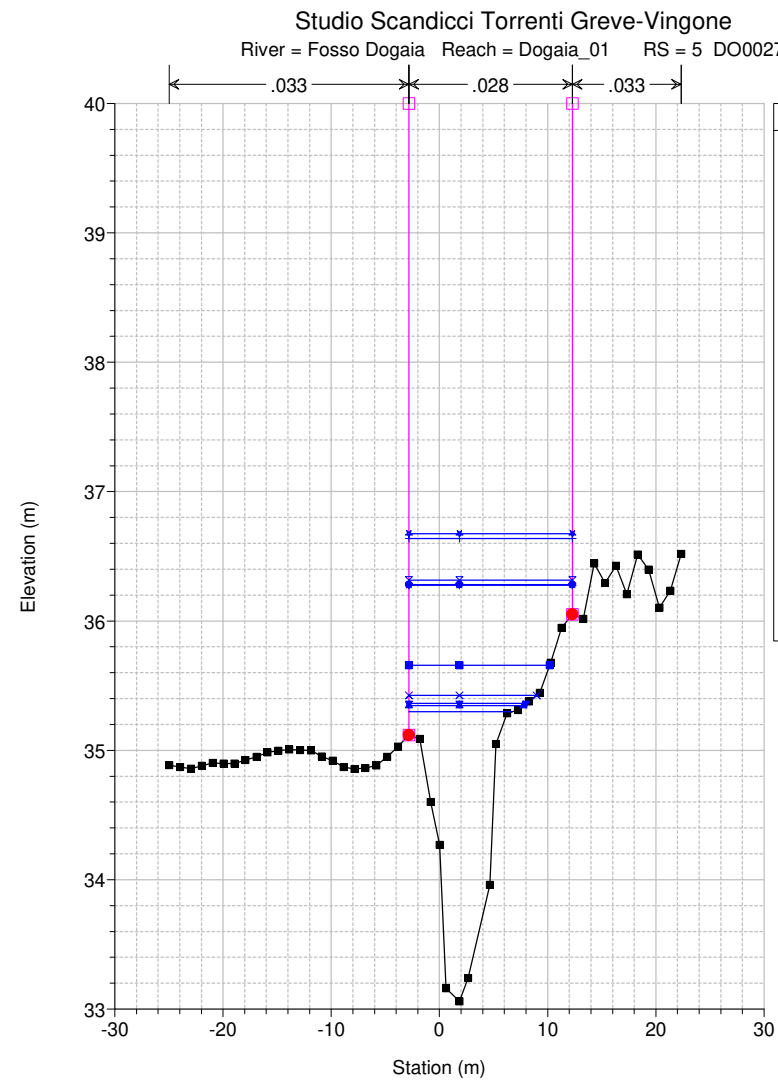

Studio Scandicci Torrenti Greve-Vingone
River = Fosso Dogaia Reach = Dogaia_01 RS = 1.75 Culv

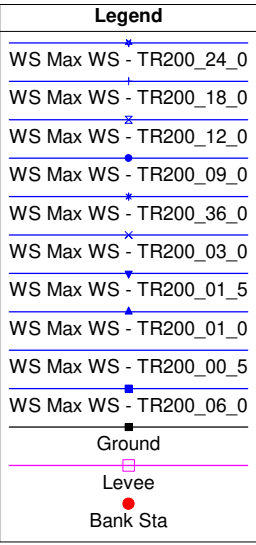
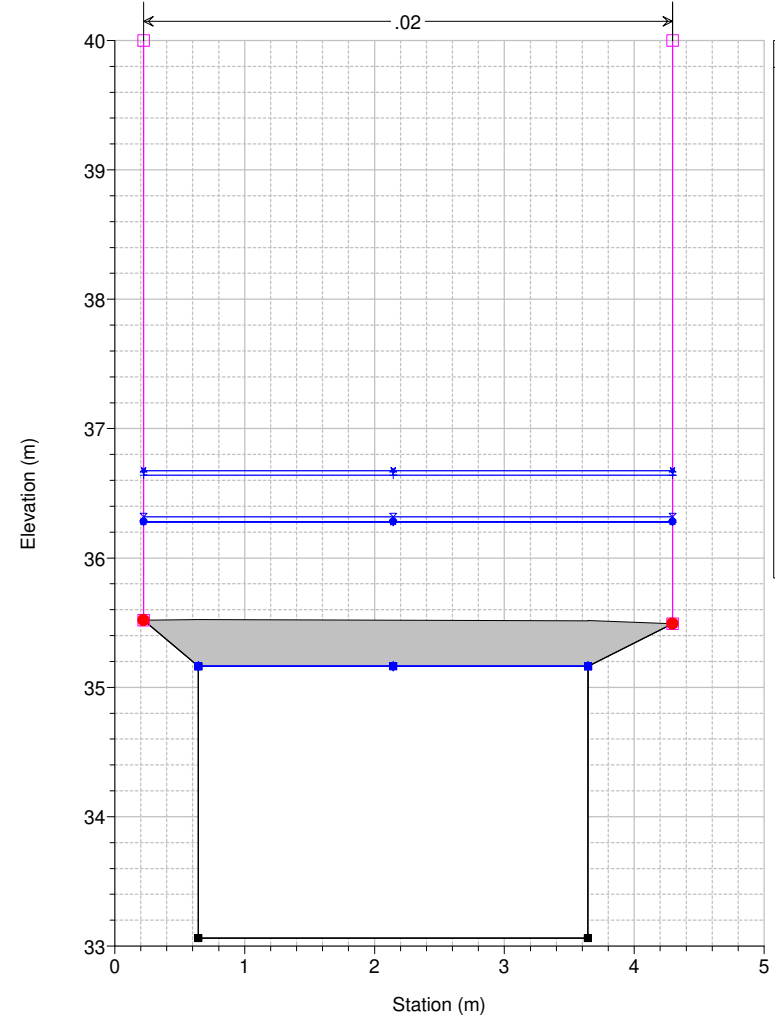

Studio Scandicci Torrenti Greve-Vingone
River = Fosso Dogaia Reach = Dogaia_01 RS = 1.75 Culv

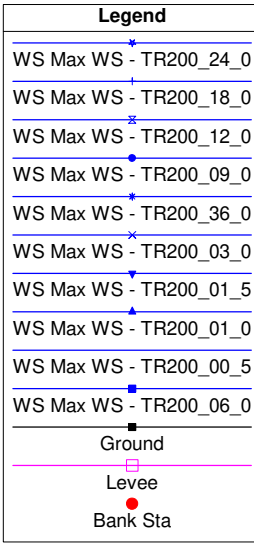
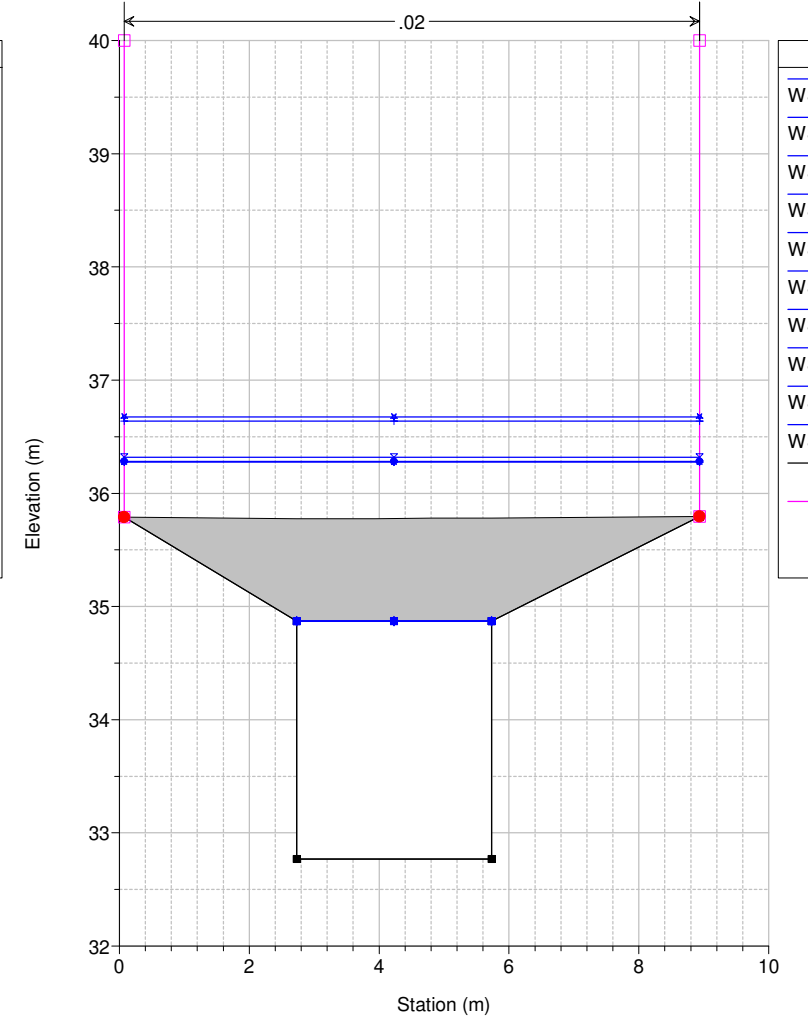

Studio Scandicci Torrenti Greve-Vingone
River = Fosso Dogaia Reach = Dogaia_01 RS = 1.4 DO0032_C

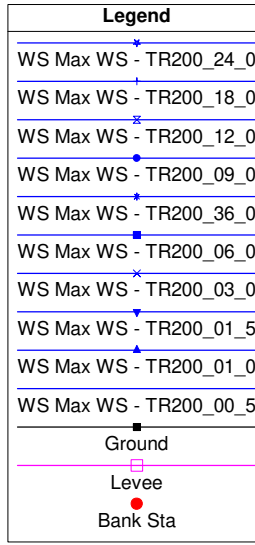
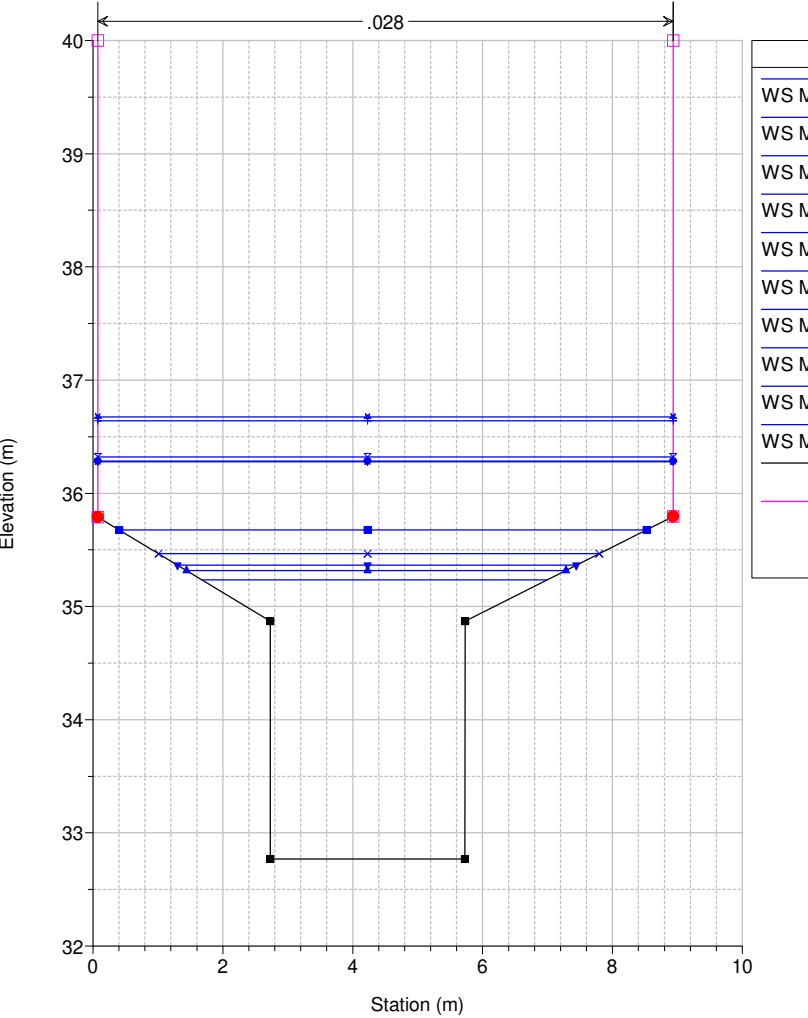

Studio Scandicci Torrenti Greve-Vingone
River = Fosso Dogaia Reach = Dogaia_01 RS = 1 DO0032_D

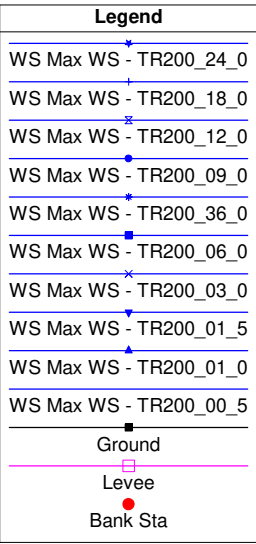
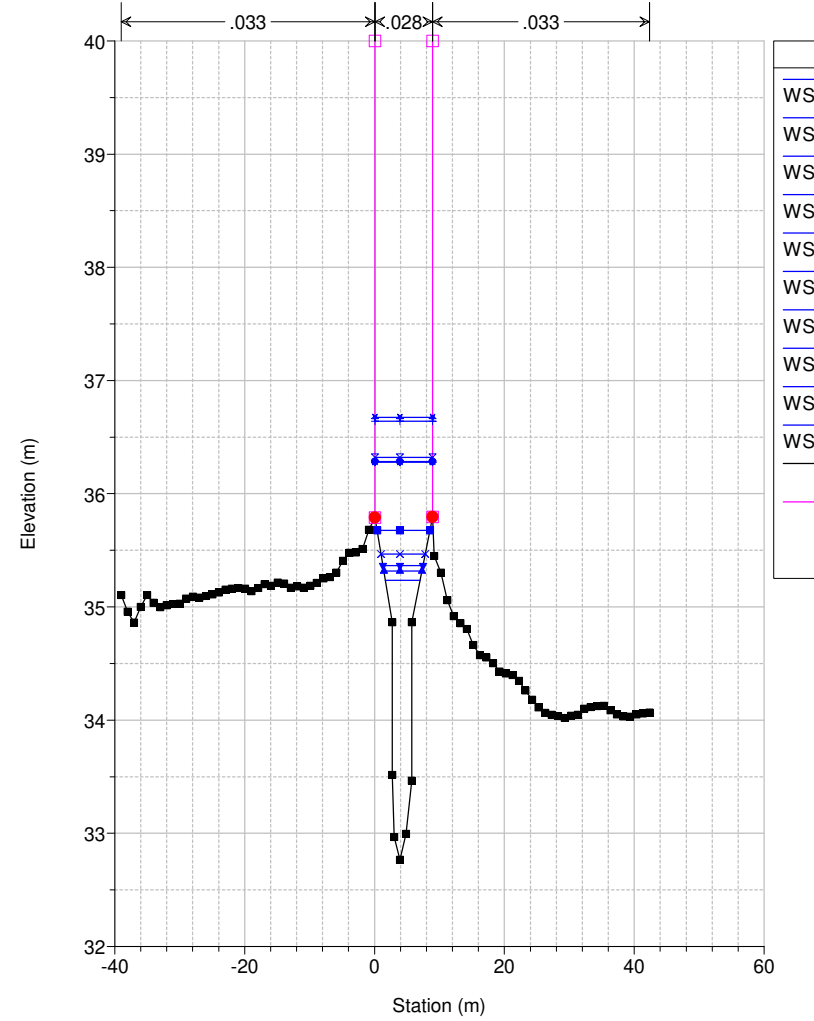

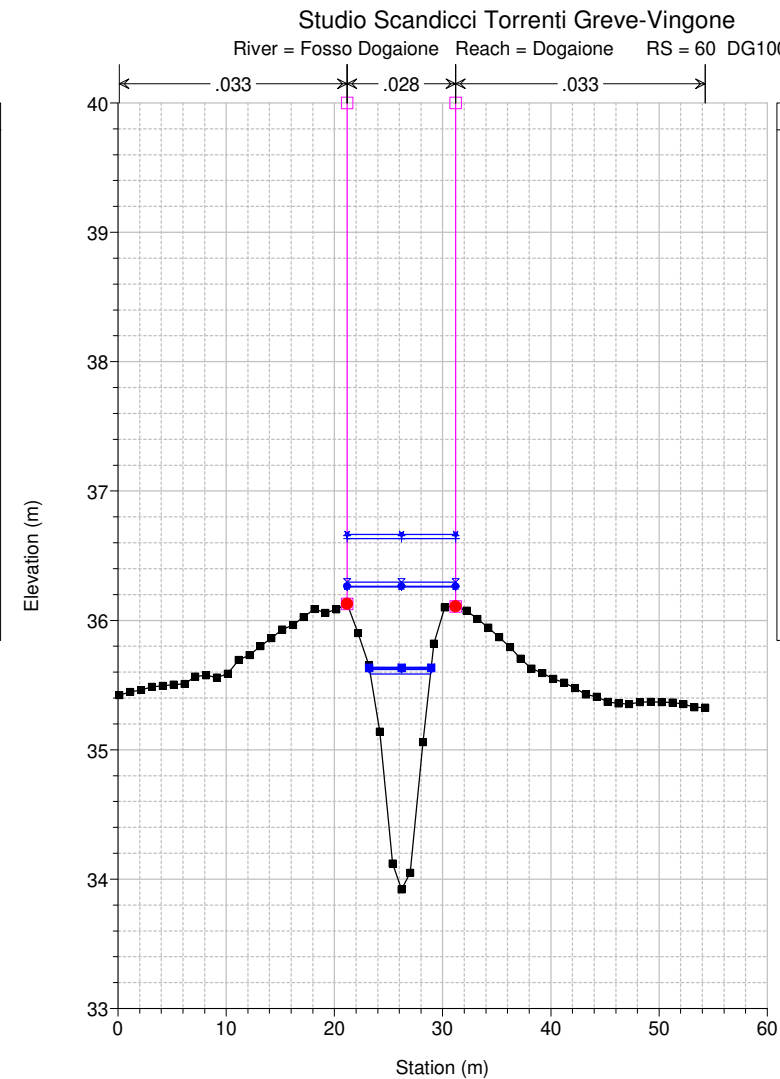
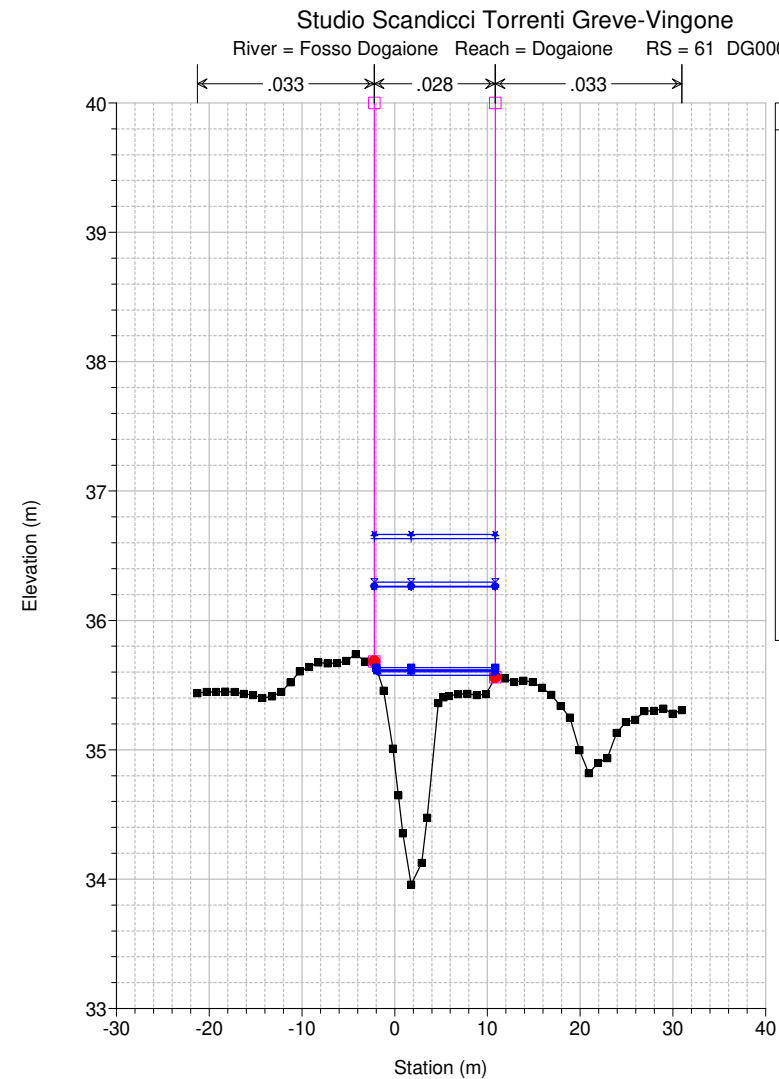
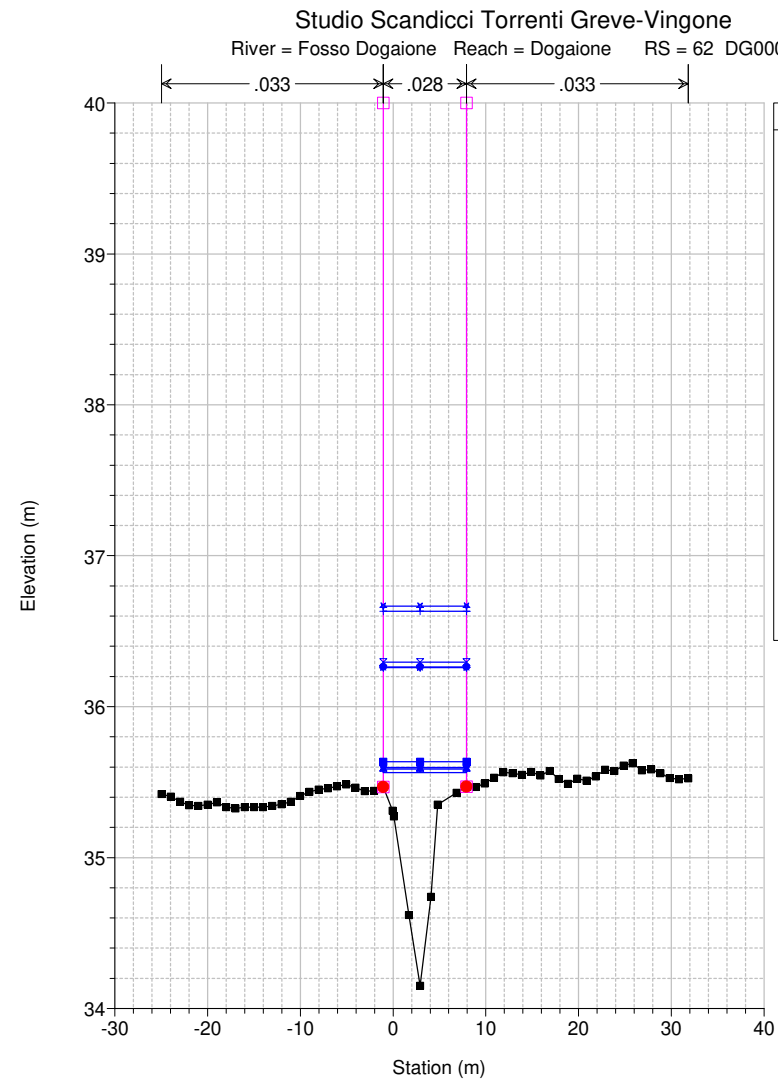
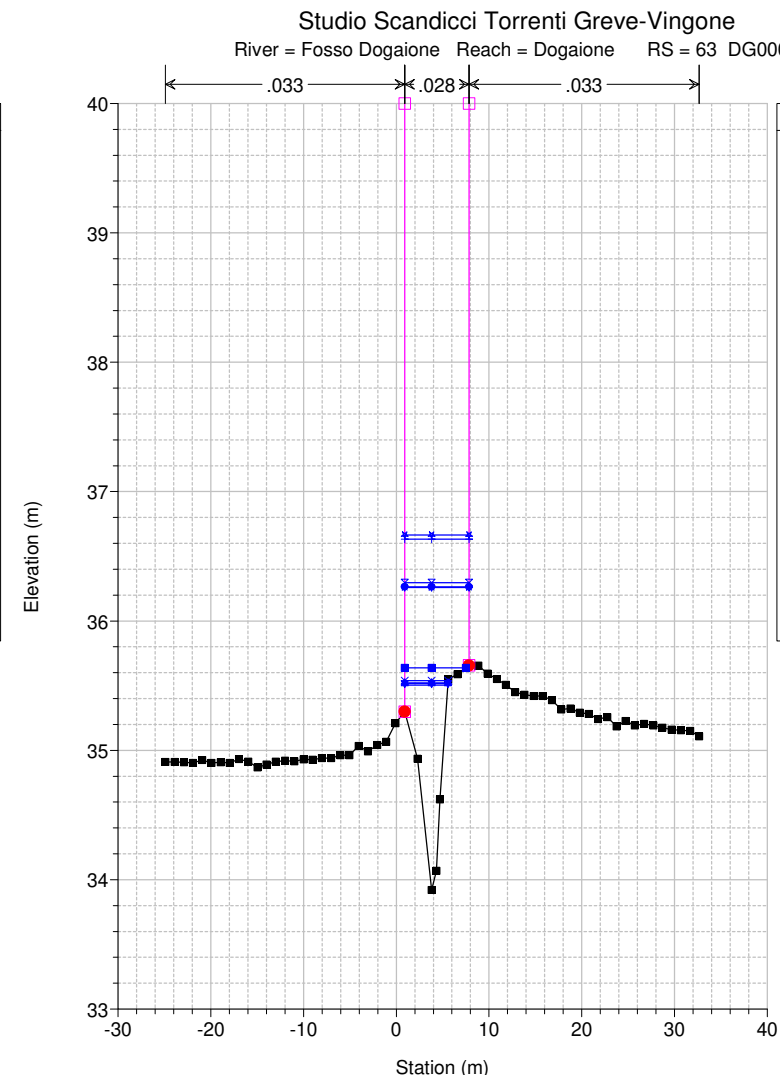
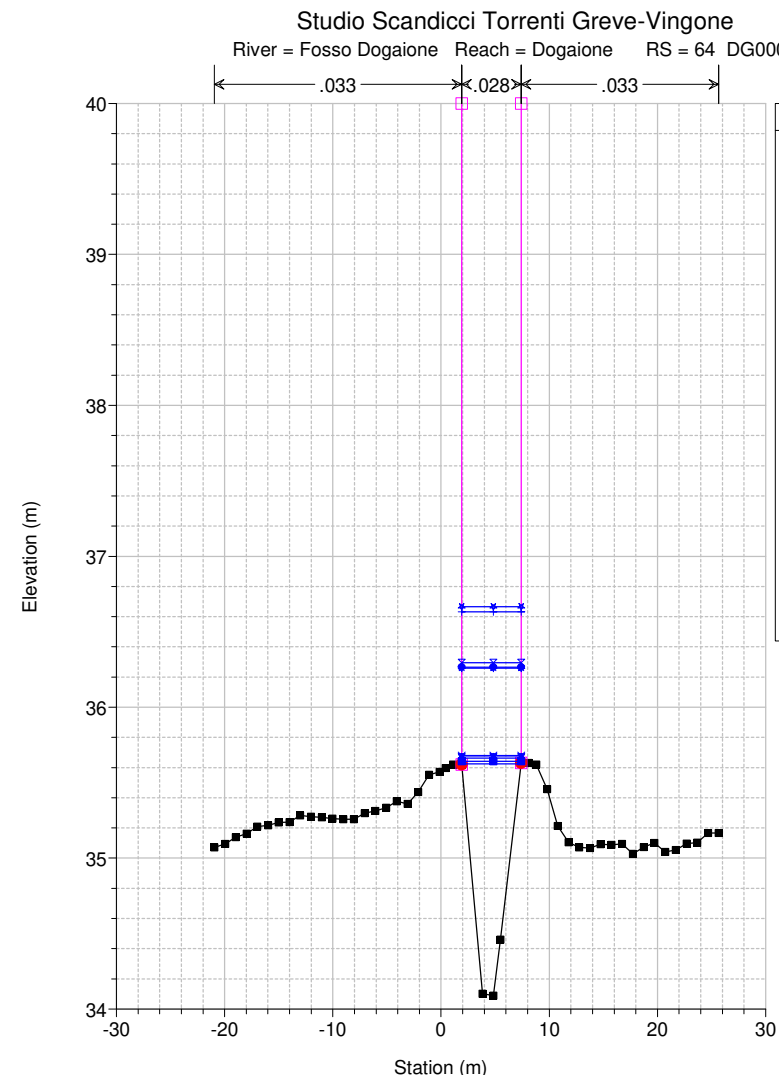
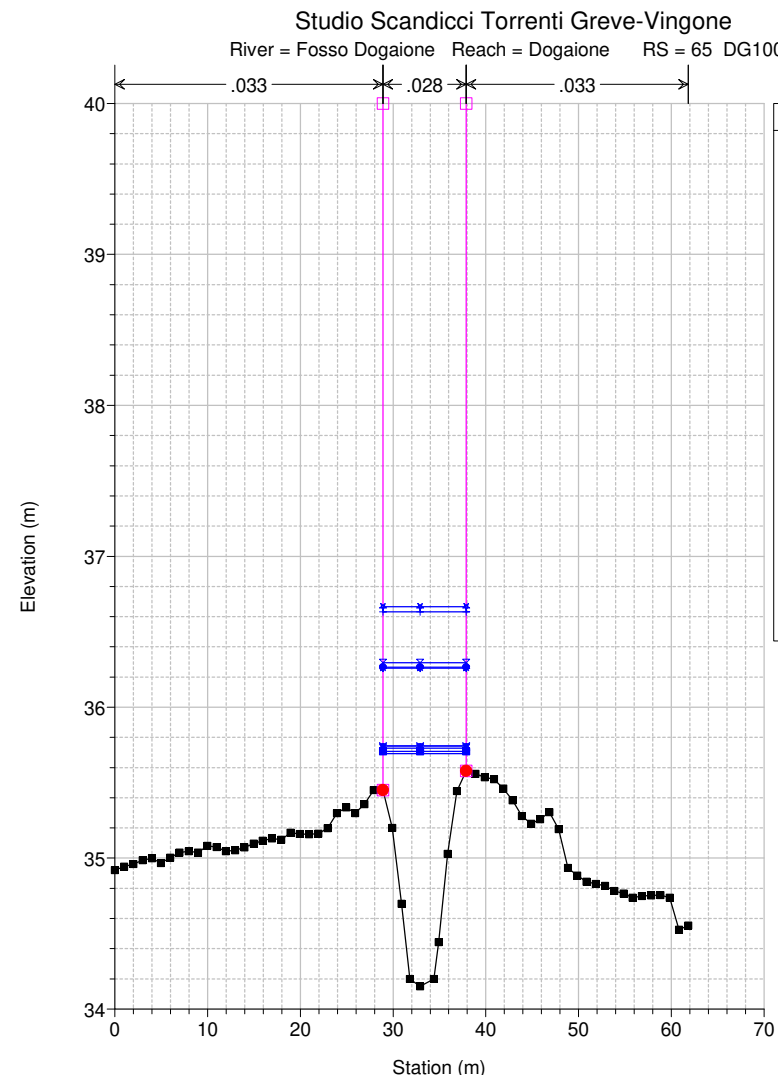

Studio Scandicci Torrenti Greve-Vingone

River = Fosso Dogaione Reach = Dogaione RS = 59 DG1006_B

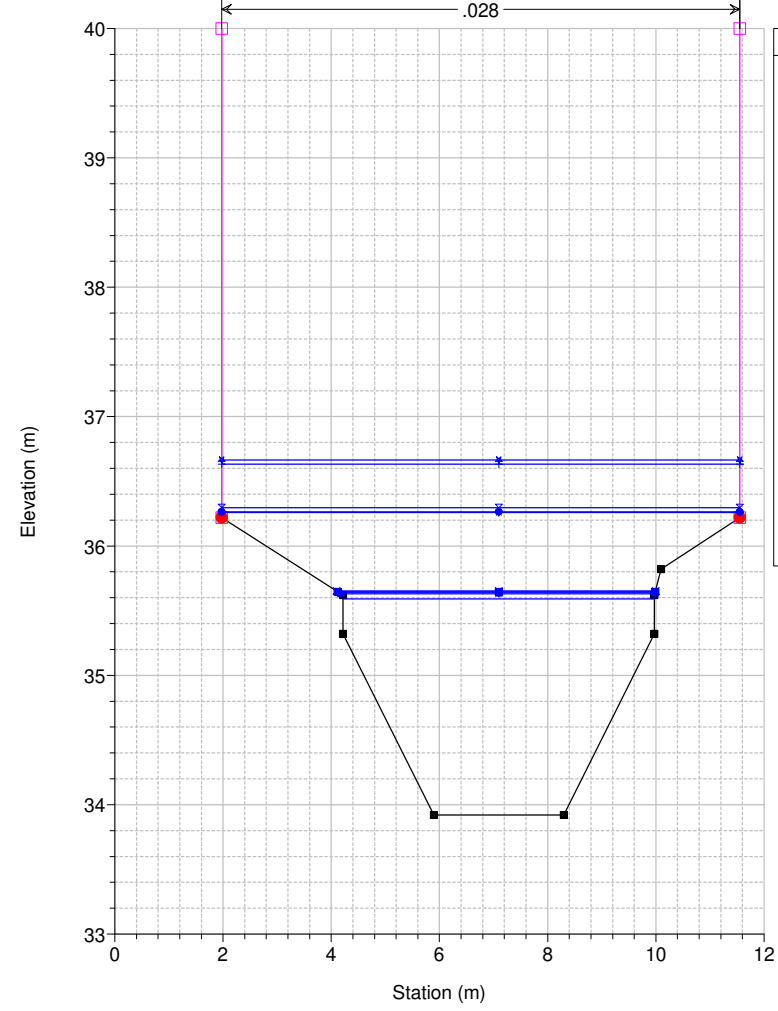

Legend

- WS Max WS - TR200_24_0
- WS Max WS - TR200_18_0
- WS Max WS - TR200_12_0
- WS Max WS - TR200_09_0
- WS Max WS - TR200_36_0
- WS Max WS - TR200_03_0
- WS Max WS - TR200_06_0
- WS Max WS - TR200_01_5
- WS Max WS - TR200_01_0
- WS Max WS - TR200_00_5
- Ground
- Levee
- Bank Sta

Studio Scandicci Torrenti Greve-Vingone

River = Fosso Dogaione Reach = Dogaione RS = 58.5 BR

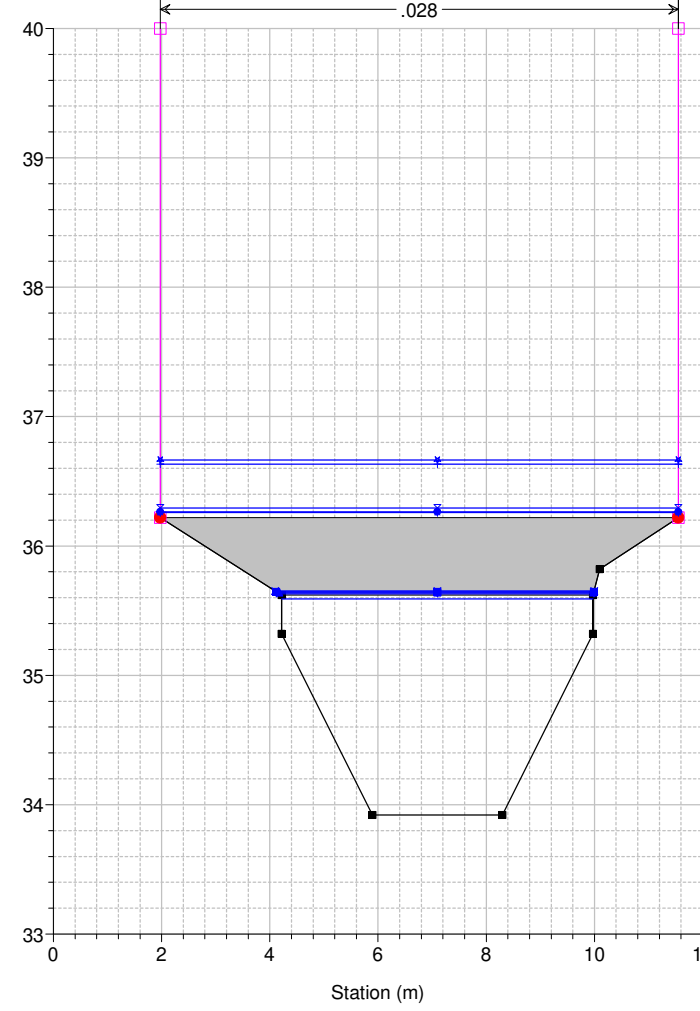

Legend

- WS Max WS - TR200_24_0
- WS Max WS - TR200_18_0
- WS Max WS - TR200_12_0
- WS Max WS - TR200_09_0
- WS Max WS - TR200_36_0
- WS Max WS - TR200_03_0
- WS Max WS - TR200_06_0
- WS Max WS - TR200_01_5
- WS Max WS - TR200_01_0
- WS Max WS - TR200_00_5
- Ground
- Levee
- Bank Sta

Studio Scandicci Torrenti Greve-Vingone

River = Fosso Dogaione Reach = Dogaione RS = 58.5 BR

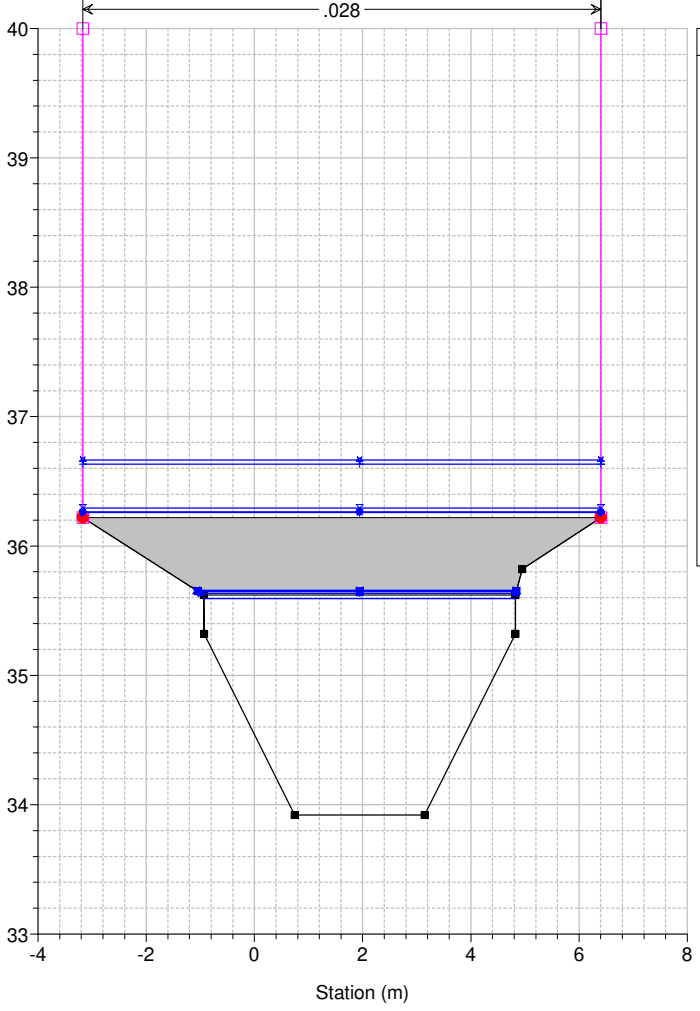

Legend

- WS Max WS - TR200_24_0
- WS Max WS - TR200_18_0
- WS Max WS - TR200_12_0
- WS Max WS - TR200_09_0
- WS Max WS - TR200_36_0
- WS Max WS - TR200_03_0
- WS Max WS - TR200_06_0
- WS Max WS - TR200_01_5
- WS Max WS - TR200_01_0
- WS Max WS - TR200_00_5
- Ground
- Levee
- Bank Sta

Studio Scandicci Torrenti Greve-Vingone

River = Fosso Dogaione Reach = Dogaione RS = 58 DG1006_C

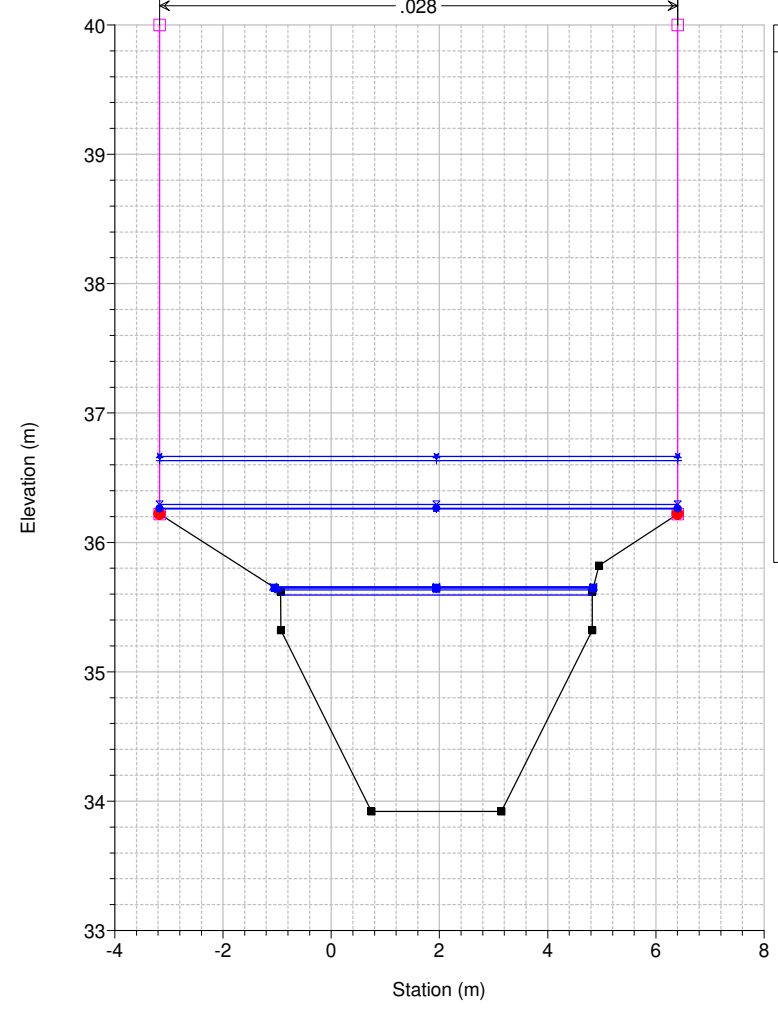

Legend

- WS Max WS - TR200_24_0
- WS Max WS - TR200_18_0
- WS Max WS - TR200_12_0
- WS Max WS - TR200_09_0
- WS Max WS - TR200_36_0
- WS Max WS - TR200_03_0
- WS Max WS - TR200_06_0
- WS Max WS - TR200_01_5
- WS Max WS - TR200_01_0
- WS Max WS - TR200_00_5
- Ground
- Levee
- Bank Sta

Studio Scandicci Torrenti Greve-Vingone

River = Fosso Dogaione Reach = Dogaione RS = 57 DG1006_D

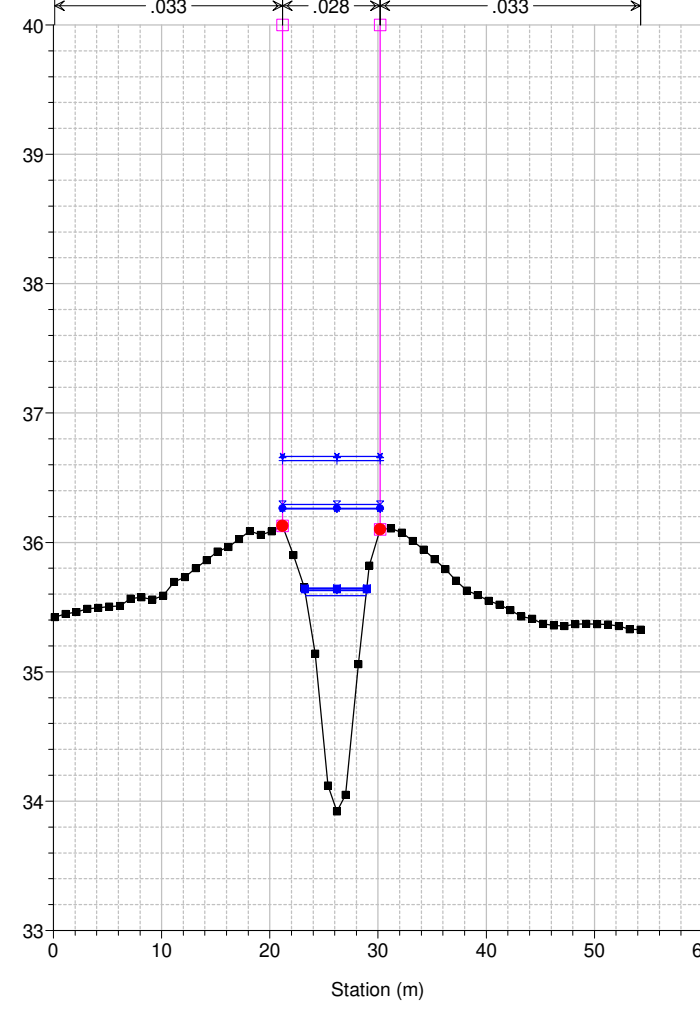

Legend

- WS Max WS - TR200_24_0
- WS Max WS - TR200_18_0
- WS Max WS - TR200_12_0
- WS Max WS - TR200_09_0
- WS Max WS - TR200_36_0
- WS Max WS - TR200_03_0
- WS Max WS - TR200_06_0
- WS Max WS - TR200_01_5
- WS Max WS - TR200_01_0
- WS Max WS - TR200_00_5
- Ground
- Levee
- Bank Sta

Studio Scandicci Torrenti Greve-Vingone

River = Fosso Dogaione Reach = Dogaione RS = 56 DG0007_A

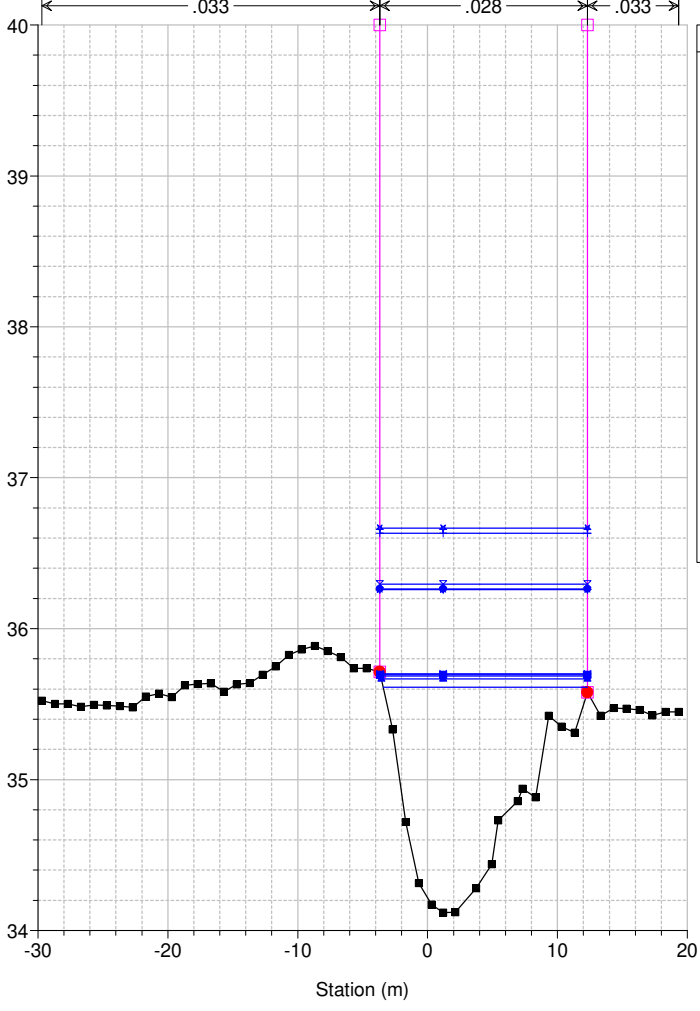

Legend

- WS Max WS - TR200_24_0
- WS Max WS - TR200_18_0
- WS Max WS - TR200_12_0
- WS Max WS - TR200_09_0
- WS Max WS - TR200_36_0
- WS Max WS - TR200_03_0
- WS Max WS - TR200_06_0
- WS Max WS - TR200_01_5
- WS Max WS - TR200_01_0
- WS Max WS - TR200_00_5
- Ground
- Levee
- Bank Sta

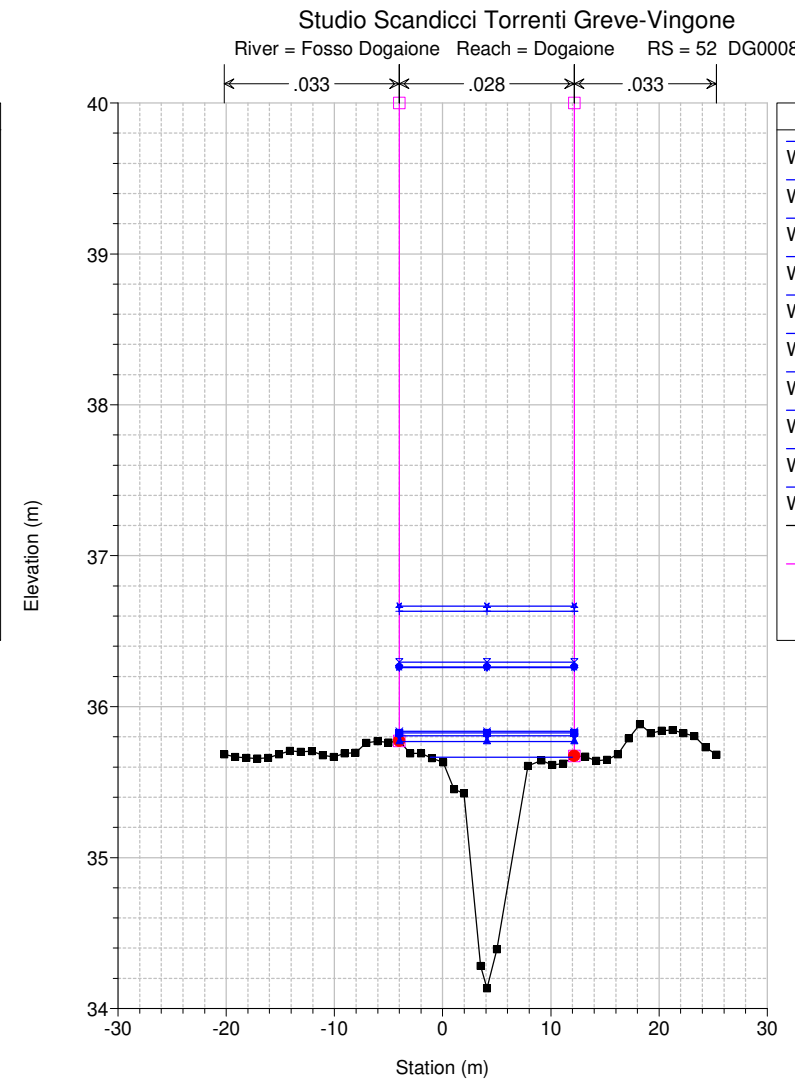
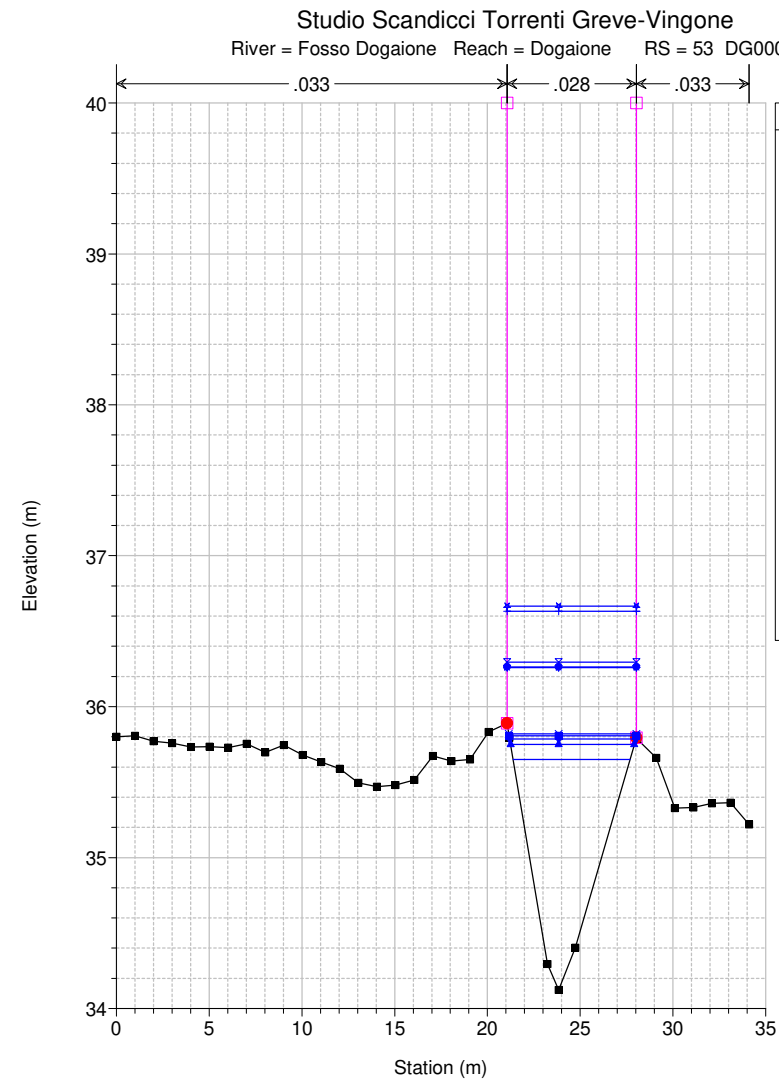
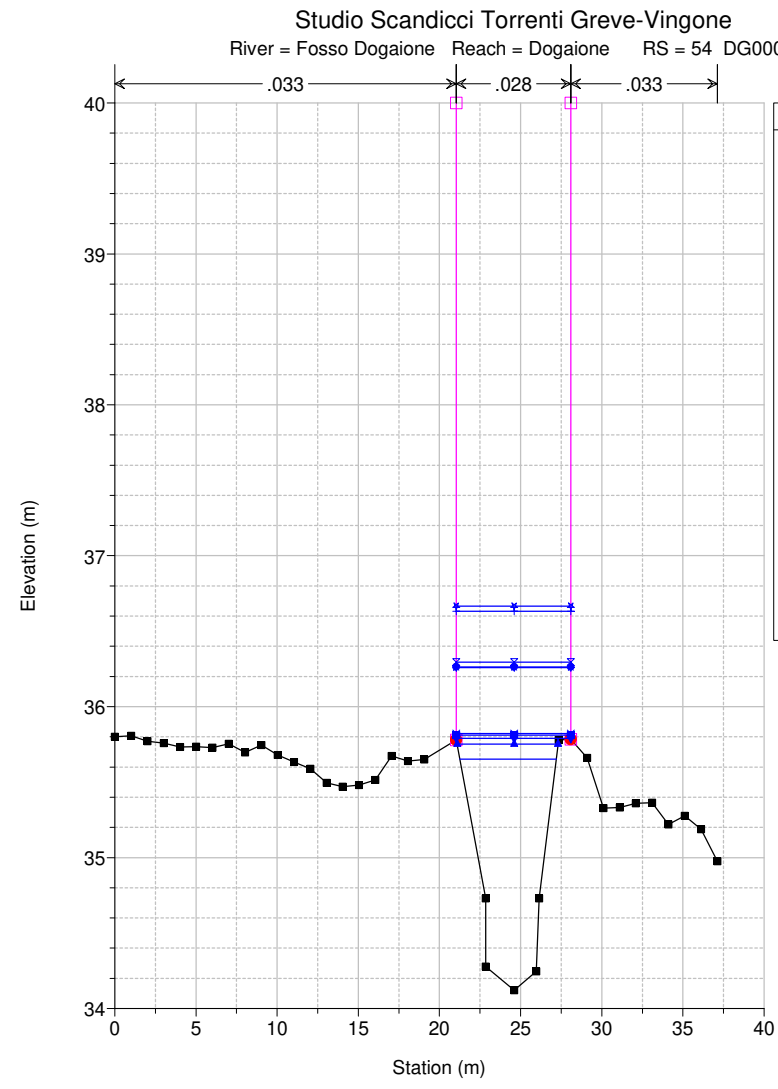
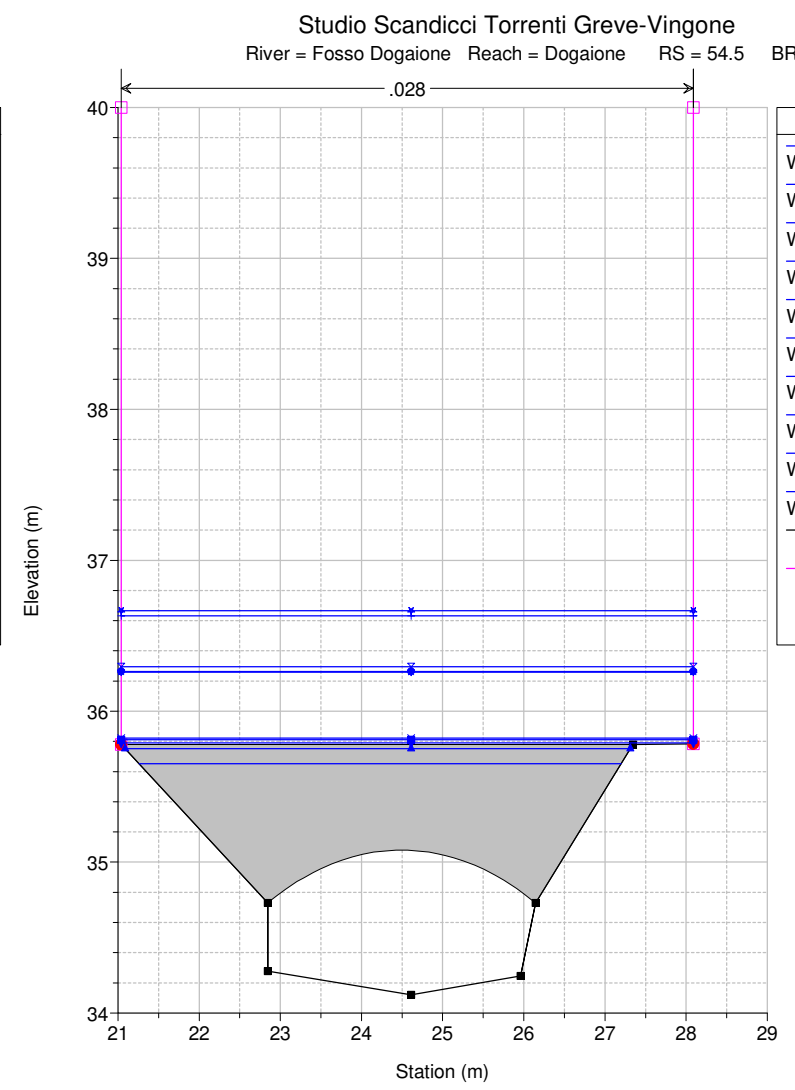
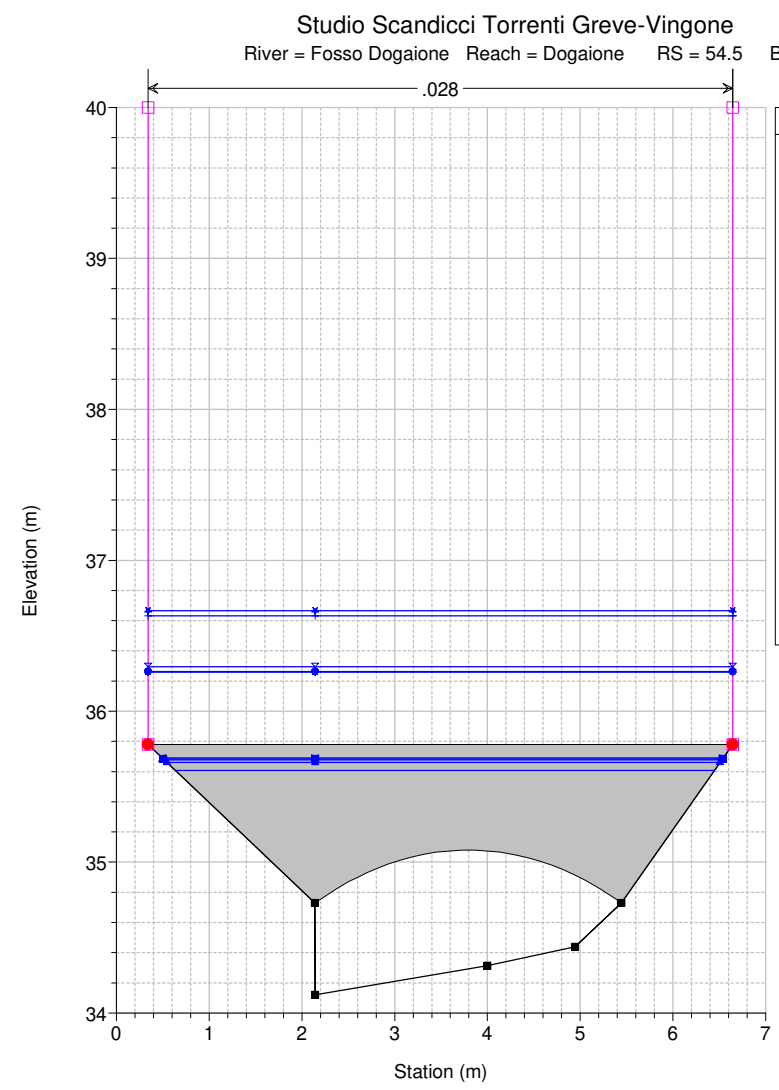
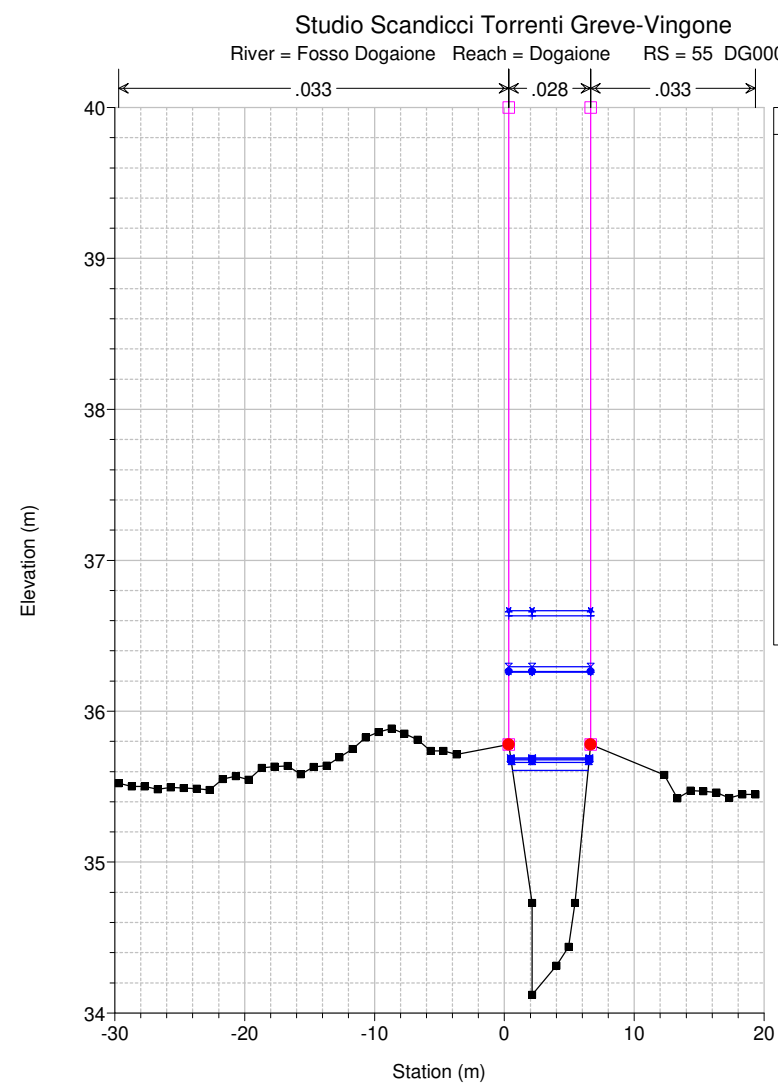

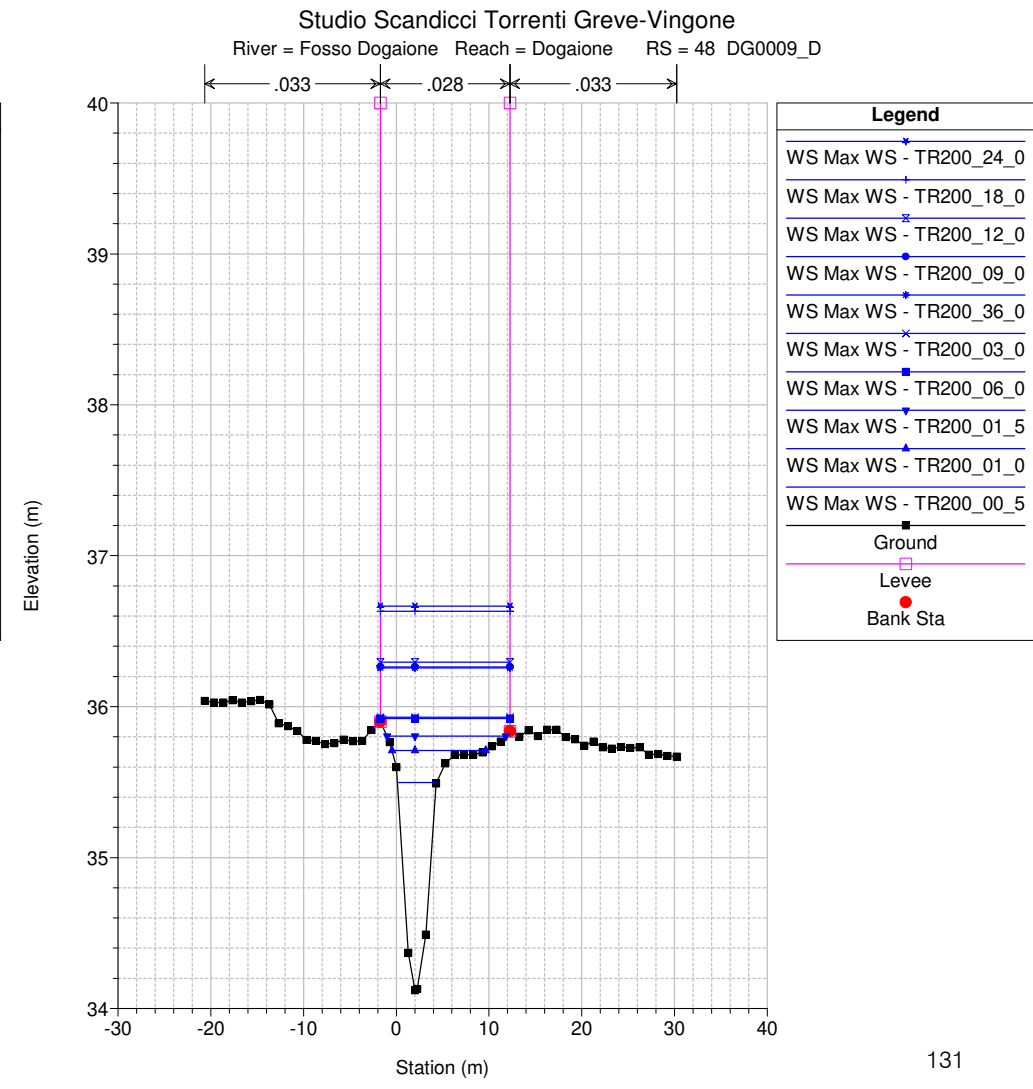
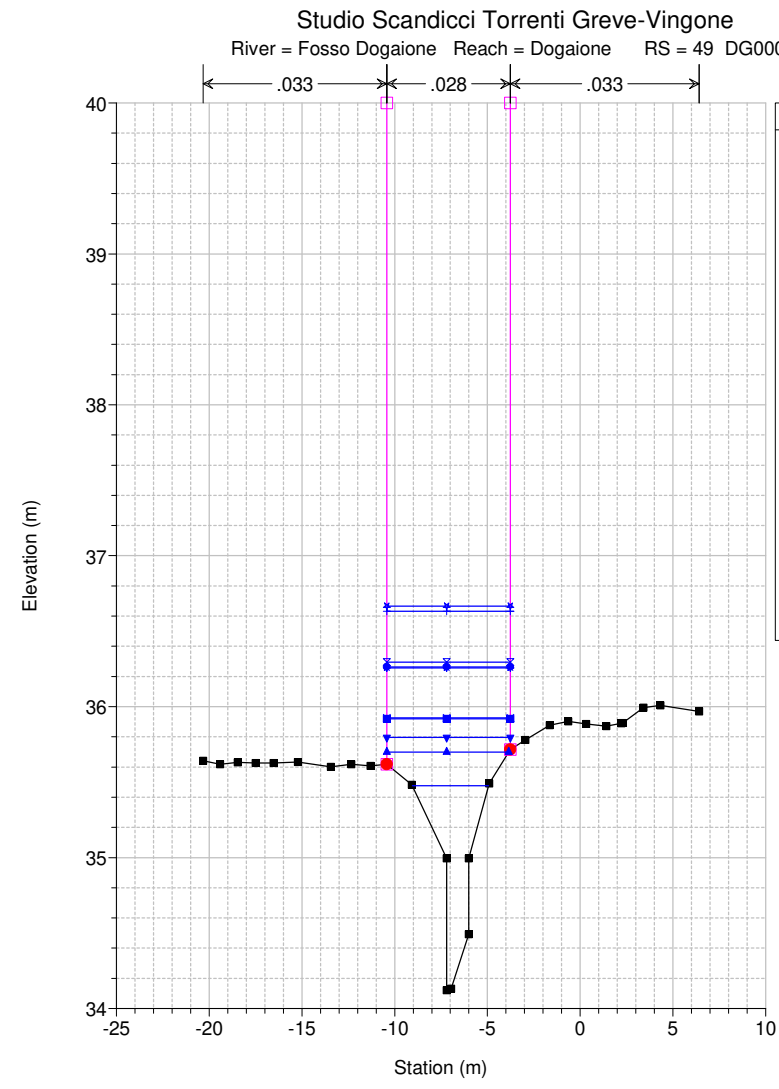
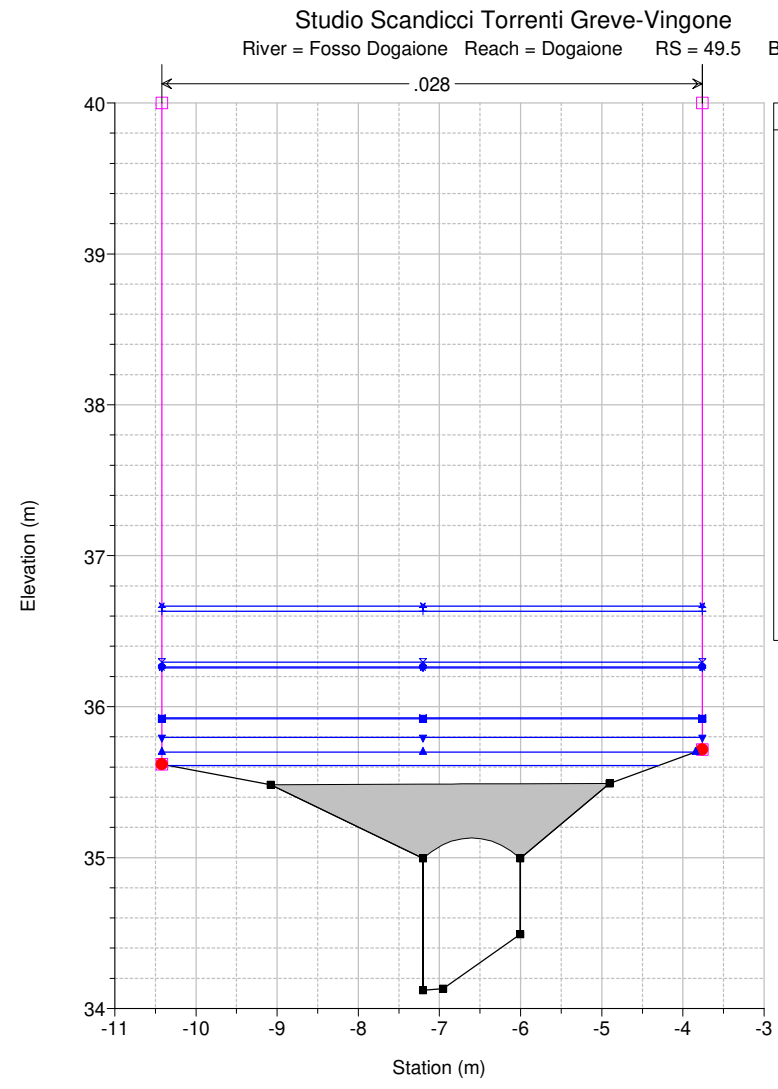
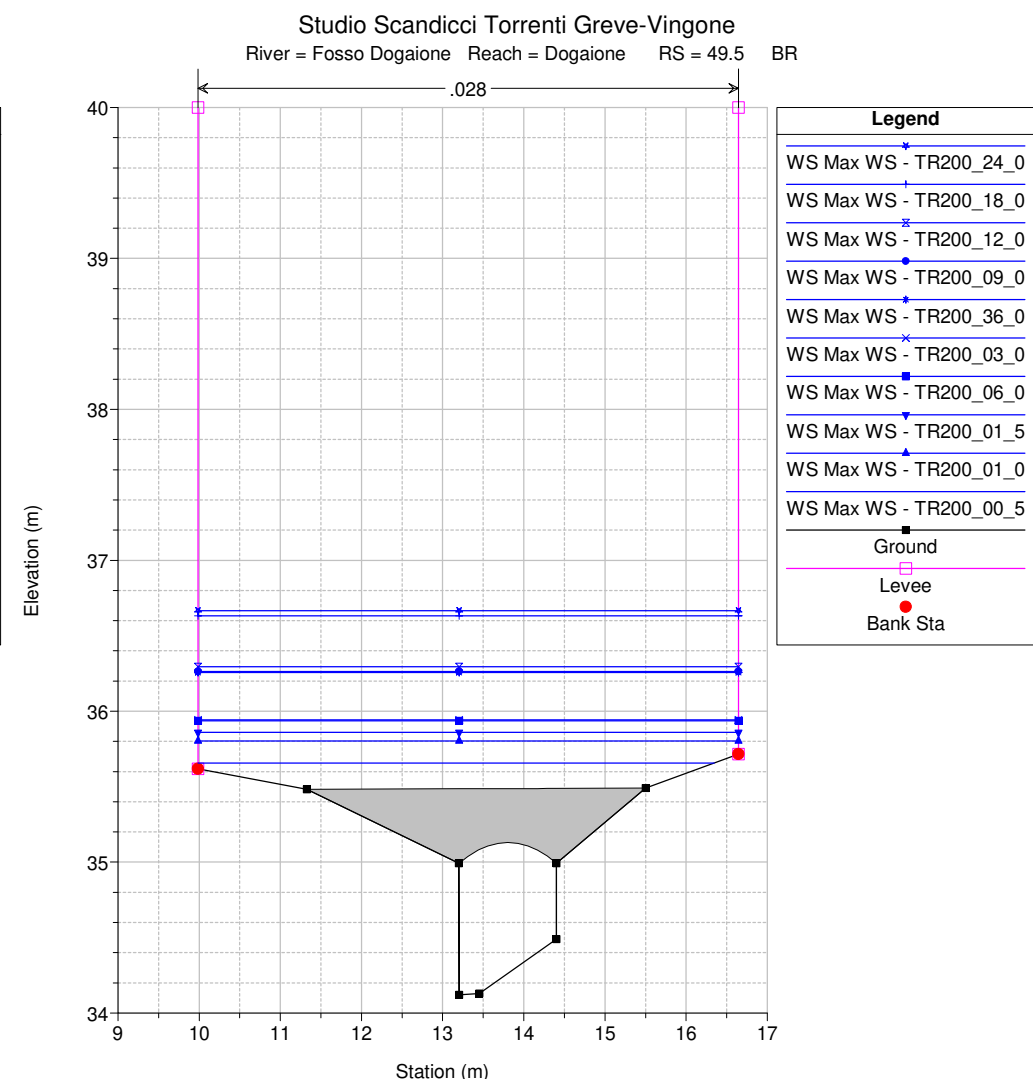
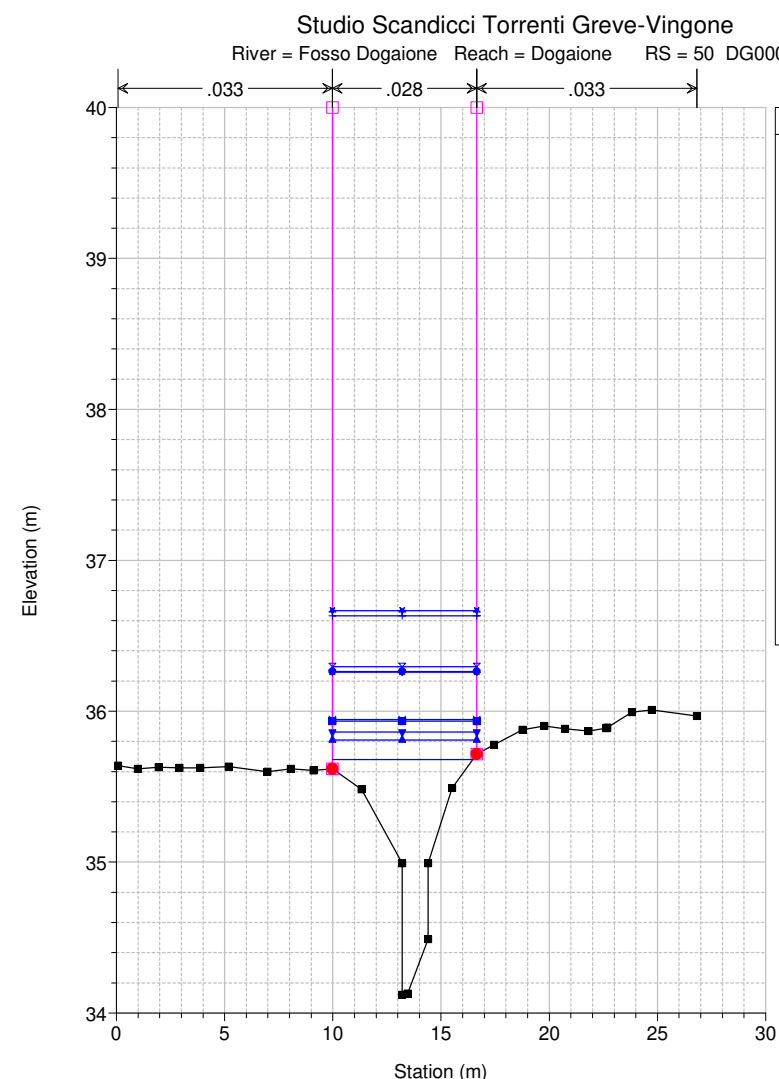
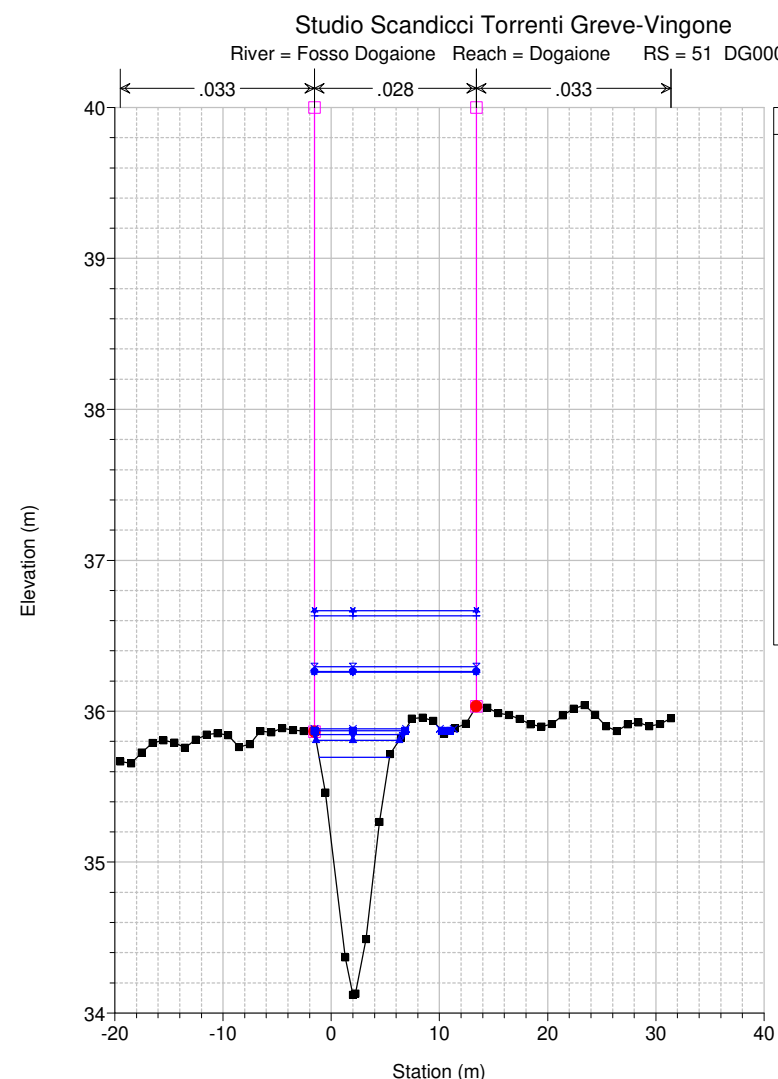

Studio Scandicci Torrenti Greve-Vingone
River = Fosso Dogaione Reach = Dogaione RS = 47 DG0010_A

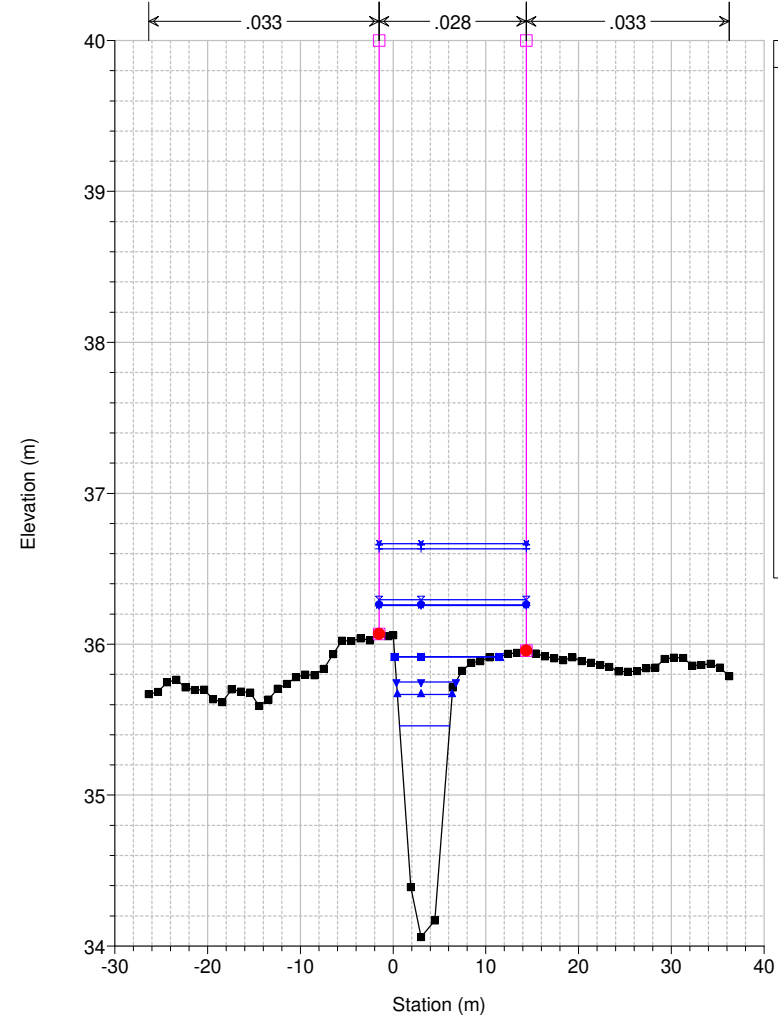

Legend	
WS Max WS - TR200_24_0	▲
WS Max WS - TR200_18_0	+
WS Max WS - TR200_12_0	×
WS Max WS - TR200_09_0	●
WS Max WS - TR200_36_0	◆
WS Max WS - TR200_03_0	▼
WS Max WS - TR200_06_0	■
WS Max WS - TR200_01_5	▽
WS Max WS - TR200_01_0	▲
WS Max WS - TR200_00_5	▲
Ground	■
Levee	□
Bank Sta	●

Studio Scandicci Torrenti Greve-Vingone
River = Fosso Dogaione Reach = Dogaione RS = 46 DG0010_B

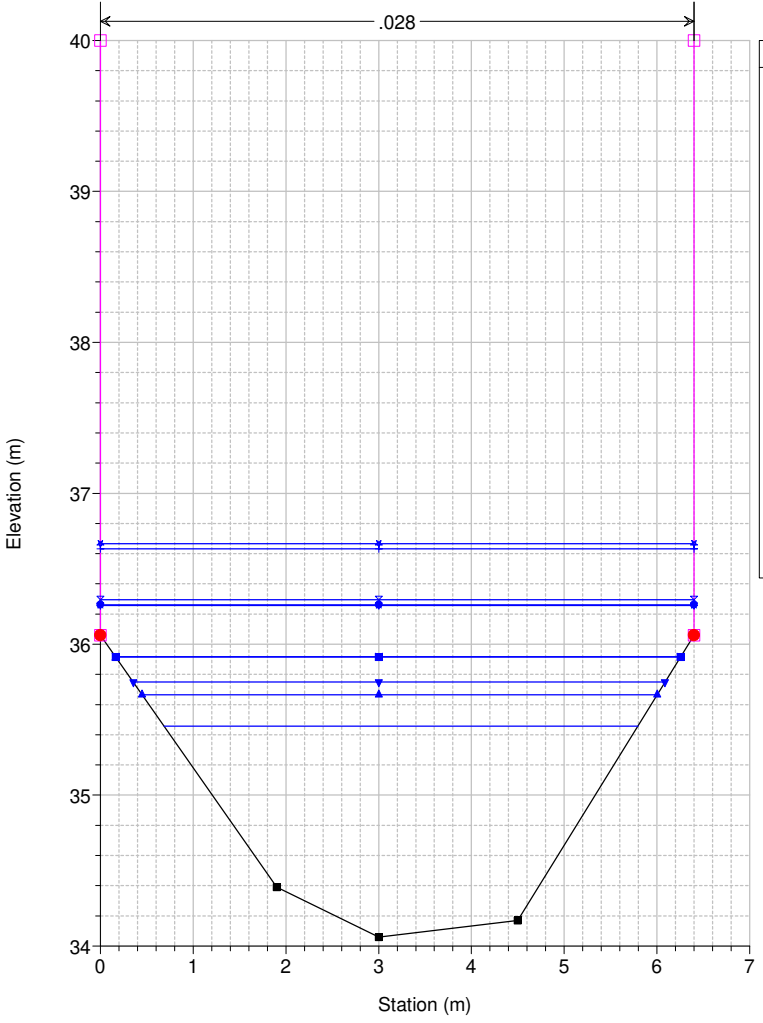

Legend	
WS Max WS - TR200_24_0	▲
WS Max WS - TR200_18_0	+
WS Max WS - TR200_12_0	×
WS Max WS - TR200_09_0	●
WS Max WS - TR200_36_0	◆
WS Max WS - TR200_03_0	▼
WS Max WS - TR200_06_0	■
WS Max WS - TR200_01_5	▽
WS Max WS - TR200_01_0	▲
WS Max WS - TR200_00_5	▲
Ground	■
Levee	□
Bank Sta	●

Studio Scandicci Torrenti Greve-Vingone
River = Fosso Dogaione Reach = Dogaione RS = 45.5 BR

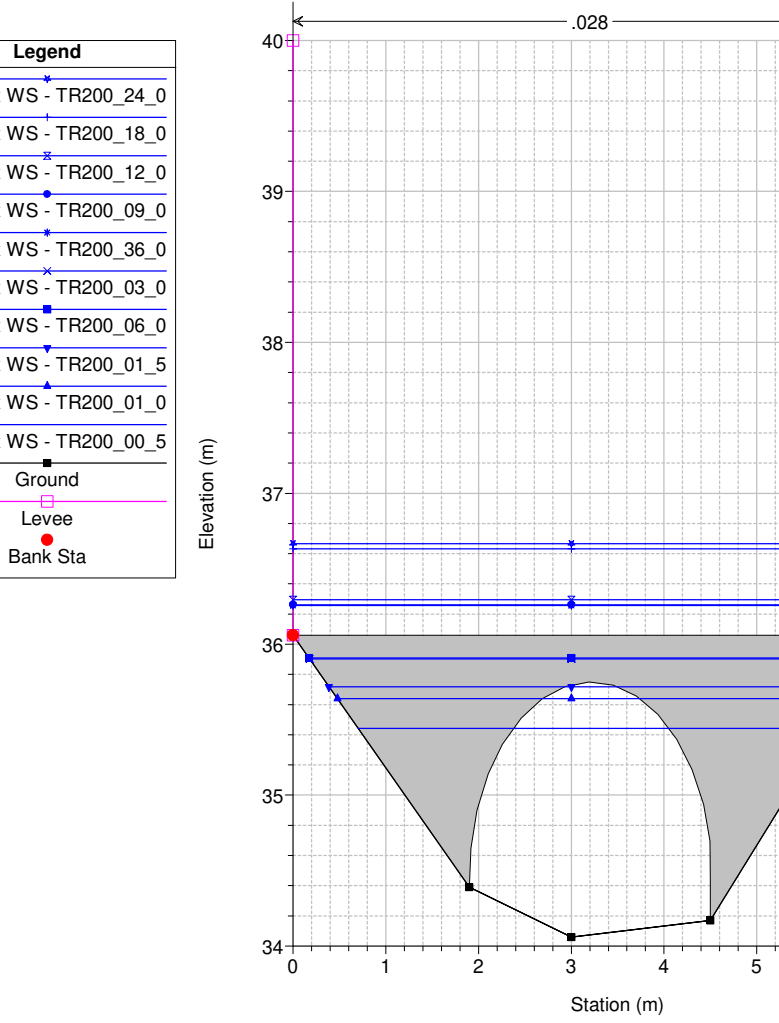

Legend	
WS Max WS - TR200_24_0	▲
WS Max WS - TR200_18_0	+
WS Max WS - TR200_12_0	×
WS Max WS - TR200_09_0	●
WS Max WS - TR200_36_0	◆
WS Max WS - TR200_03_0	▼
WS Max WS - TR200_06_0	■
WS Max WS - TR200_01_5	▽
WS Max WS - TR200_01_0	▲
WS Max WS - TR200_00_5	▲
Ground	■
Levee	□
Bank Sta	●

Studio Scandicci Torrenti Greve-Vingone
River = Fosso Dogaione Reach = Dogaione RS = 45.5 BR

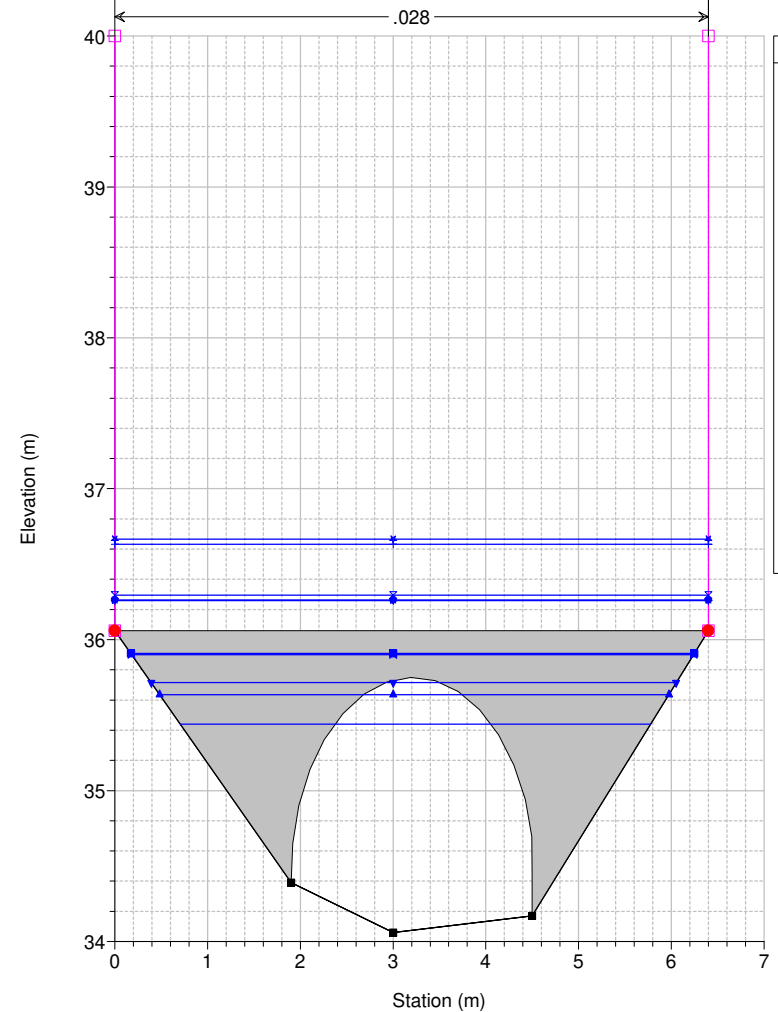

Legend	
WS Max WS - TR200_24_0	▲
WS Max WS - TR200_18_0	+
WS Max WS - TR200_12_0	×
WS Max WS - TR200_09_0	●
WS Max WS - TR200_36_0	◆
WS Max WS - TR200_03_0	▼
WS Max WS - TR200_06_0	■
WS Max WS - TR200_01_5	▽
WS Max WS - TR200_01_0	▲
WS Max WS - TR200_00_5	▲
Ground	■
Levee	□
Bank Sta	●

Studio Scandicci Torrenti Greve-Vingone
River = Fosso Dogaione Reach = Dogaione RS = 45 DG0010_C

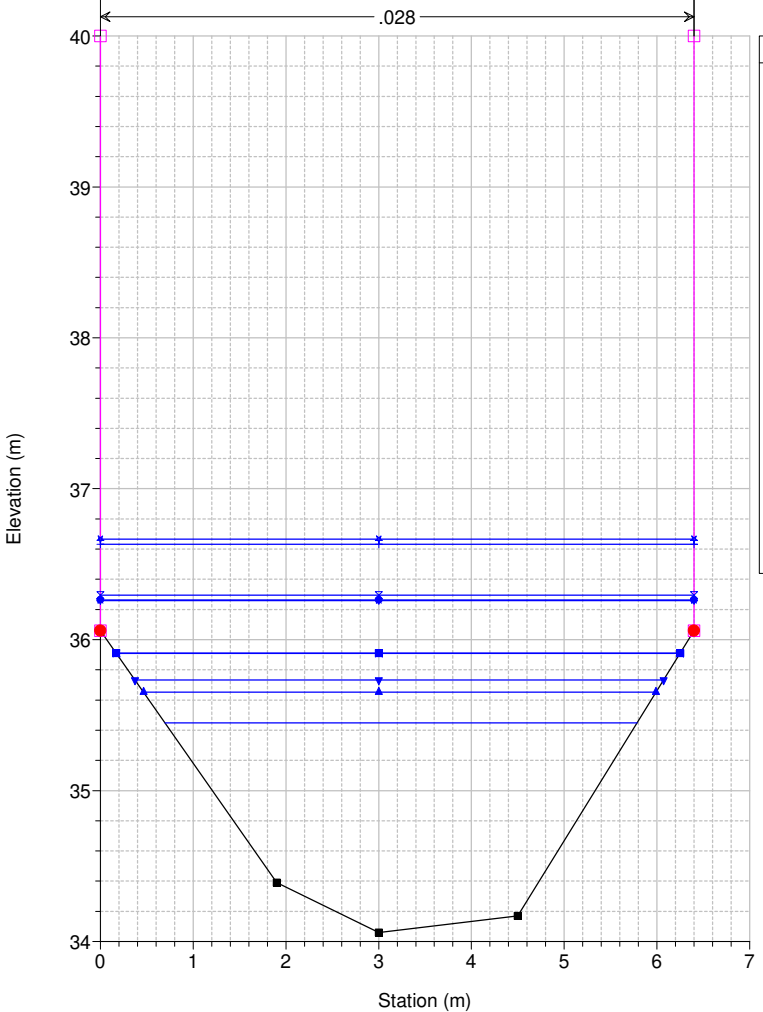

Legend	
WS Max WS - TR200_24_0	▲
WS Max WS - TR200_18_0	+
WS Max WS - TR200_12_0	×
WS Max WS - TR200_09_0	●
WS Max WS - TR200_36_0	◆
WS Max WS - TR200_03_0	▼
WS Max WS - TR200_06_0	■
WS Max WS - TR200_01_5	▽
WS Max WS - TR200_01_0	▲
WS Max WS - TR200_00_5	▲
Ground	■
Levee	□
Bank Sta	●

Studio Scandicci Torrenti Greve-Vingone
River = Fosso Dogaione Reach = Dogaione RS = 44 DG0010_D

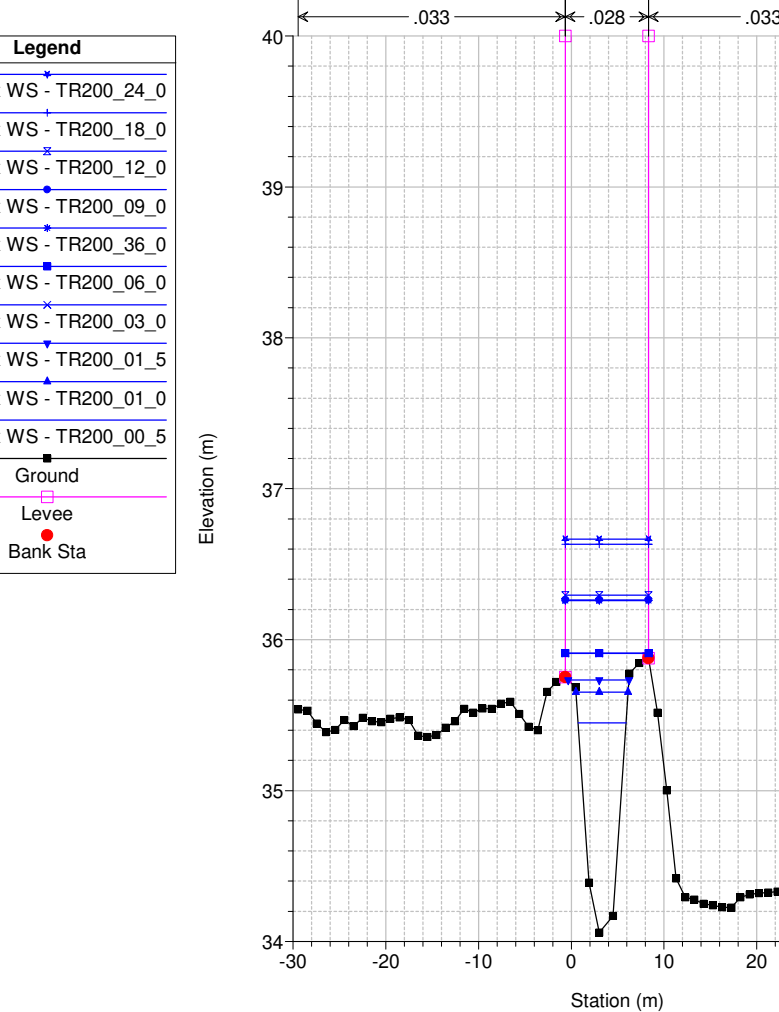

Legend	
WS Max WS - TR200_24_0	▲
WS Max WS - TR200_18_0	+
WS Max WS - TR200_12_0	×
WS Max WS - TR200_09_0	●
WS Max WS - TR200_36_0	◆
WS Max WS - TR200_03_0	▼
WS Max WS - TR200_06_0	■
WS Max WS - TR200_01_5	▽
WS Max WS - TR200_01_0	▲
WS Max WS - TR200_00_5	▲
Ground	■
Levee	□
Bank Sta	●

Studio Scandicci Torrenti Greve-Vingone
River = Fosso Dogaione Reach = Dogaione RS = 43 DG1011_A

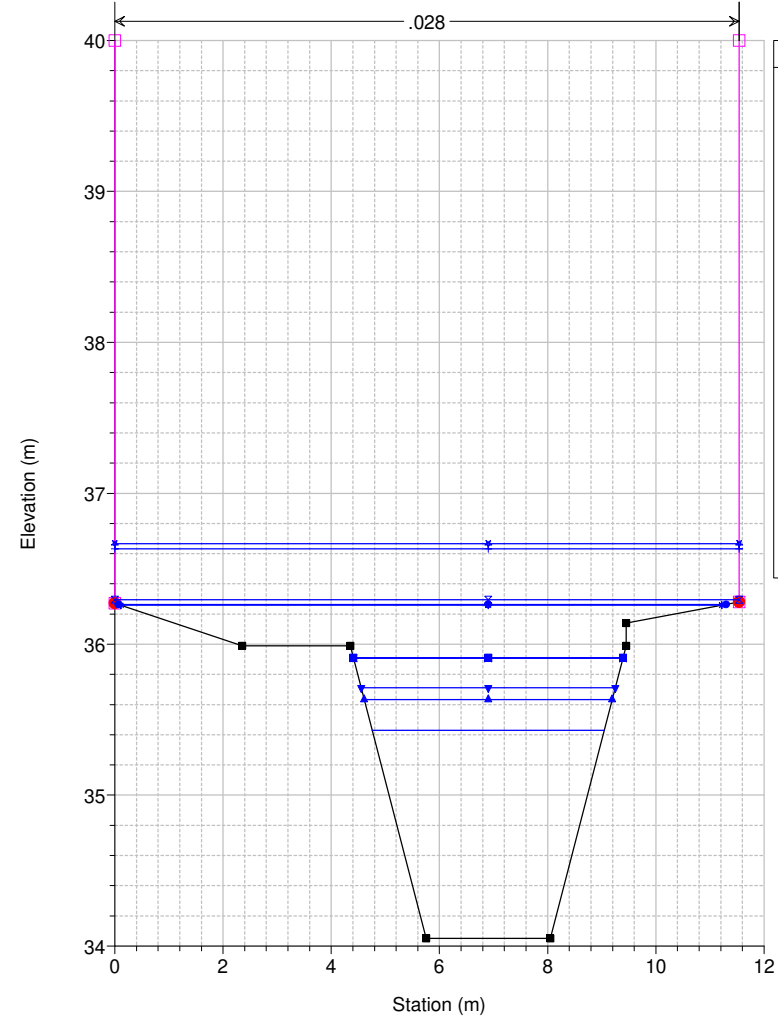

Legend

- WS Max WS - TR200_24_0
- WS Max WS - TR200_18_0
- WS Max WS - TR200_12_0
- WS Max WS - TR200_09_0
- WS Max WS - TR200_36_0
- WS Max WS - TR200_06_0
- WS Max WS - TR200_03_0
- WS Max WS - TR200_01_5
- WS Max WS - TR200_01_0
- WS Max WS - TR200_00_5
- Ground
- Levee
- Bank Sta

Studio Scandicci Torrenti Greve-Vingone
River = Fosso Dogaione Reach = Dogaione RS = 42 DG1011_B

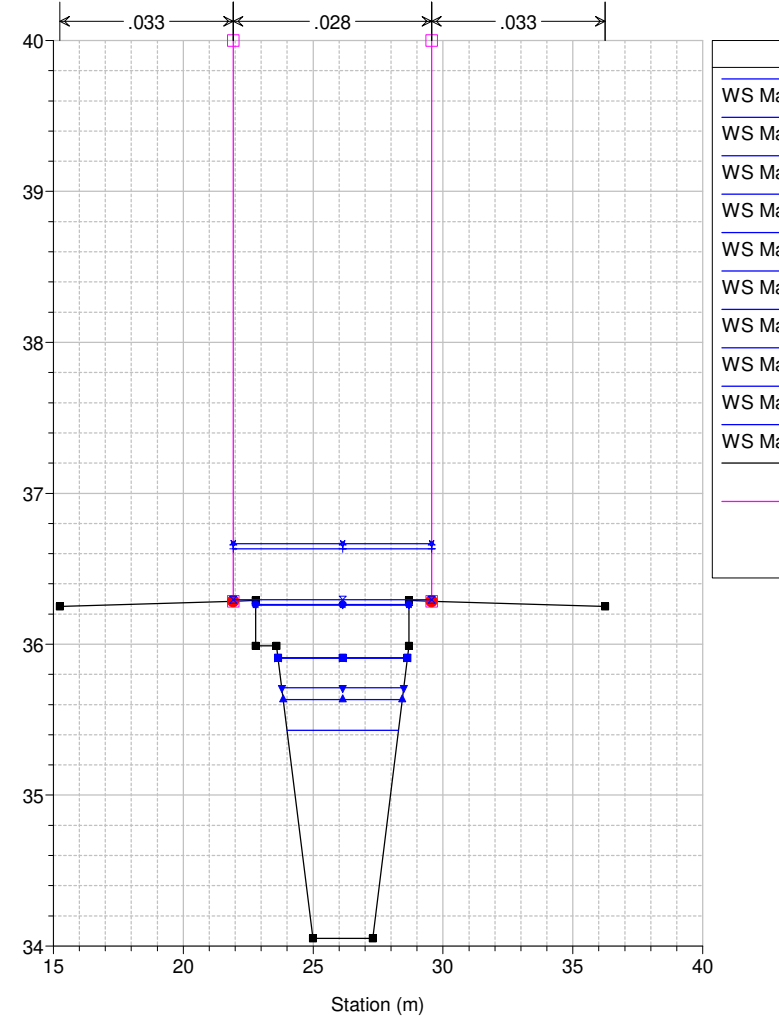

Legend

- WS Max WS - TR200_24_0
- WS Max WS - TR200_18_0
- WS Max WS - TR200_12_0
- WS Max WS - TR200_09_0
- WS Max WS - TR200_36_0
- WS Max WS - TR200_06_0
- WS Max WS - TR200_03_0
- WS Max WS - TR200_01_5
- WS Max WS - TR200_01_0
- WS Max WS - TR200_00_5
- Ground
- Levee
- Bank Sta

Studio Scandicci Torrenti Greve-Vingone
River = Fosso Dogaione Reach = Dogaione RS = 41.5 BR

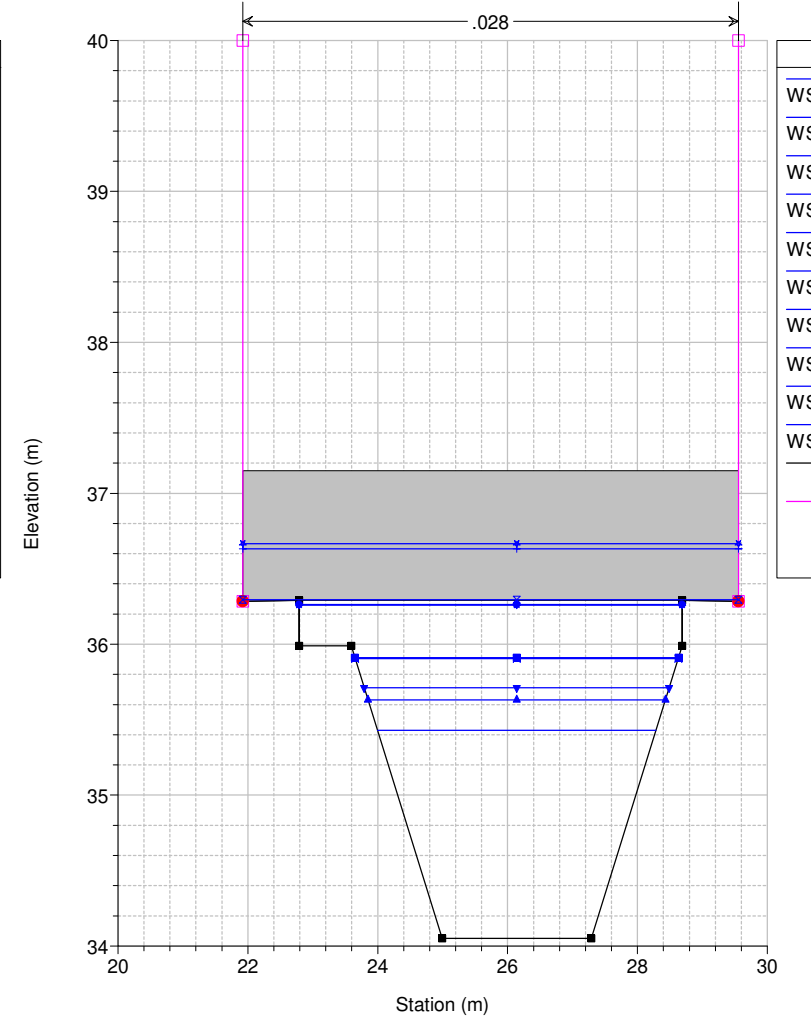

Legend

- WS Max WS - TR200_24_0
- WS Max WS - TR200_18_0
- WS Max WS - TR200_12_0
- WS Max WS - TR200_09_0
- WS Max WS - TR200_36_0
- WS Max WS - TR200_06_0
- WS Max WS - TR200_03_0
- WS Max WS - TR200_01_5
- WS Max WS - TR200_01_0
- WS Max WS - TR200_00_5
- Ground
- Levee
- Bank Sta

Studio Scandicci Torrenti Greve-Vingone
River = Fosso Dogaione Reach = Dogaione RS = 41.5 BR

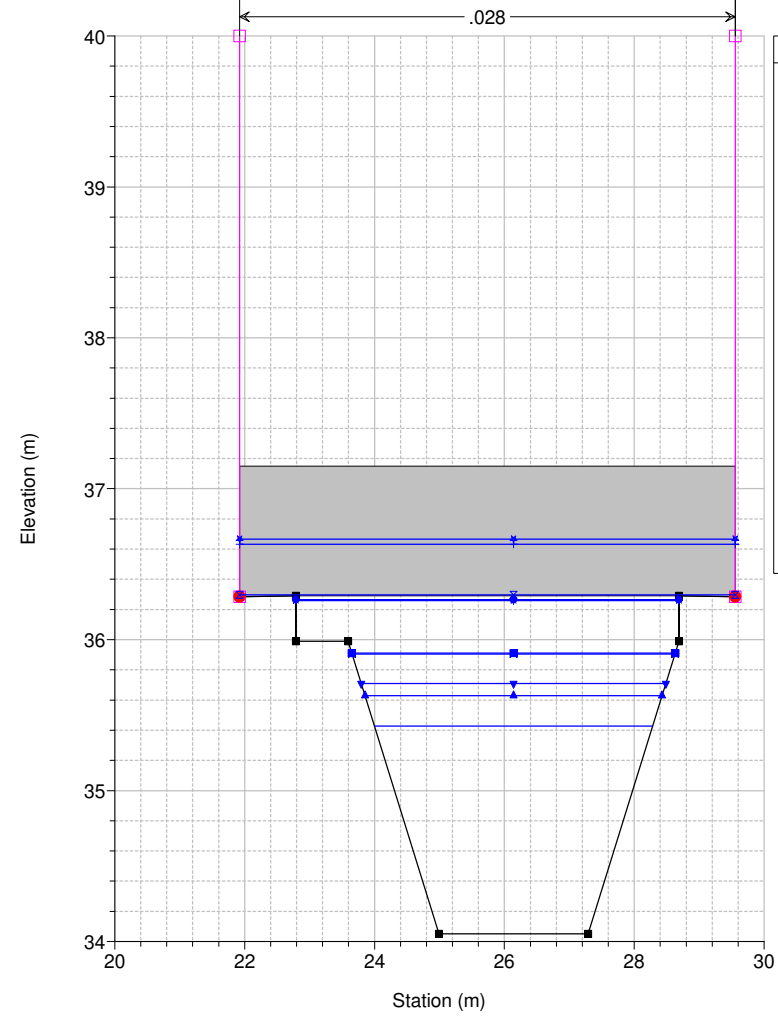

Legend

- WS Max WS - TR200_24_0
- WS Max WS - TR200_18_0
- WS Max WS - TR200_12_0
- WS Max WS - TR200_09_0
- WS Max WS - TR200_36_0
- WS Max WS - TR200_06_0
- WS Max WS - TR200_03_0
- WS Max WS - TR200_01_5
- WS Max WS - TR200_01_0
- WS Max WS - TR200_00_5
- Ground
- Levee
- Bank Sta

Studio Scandicci Torrenti Greve-Vingone
River = Fosso Dogaione Reach = Dogaione RS = 41 DG1011_C

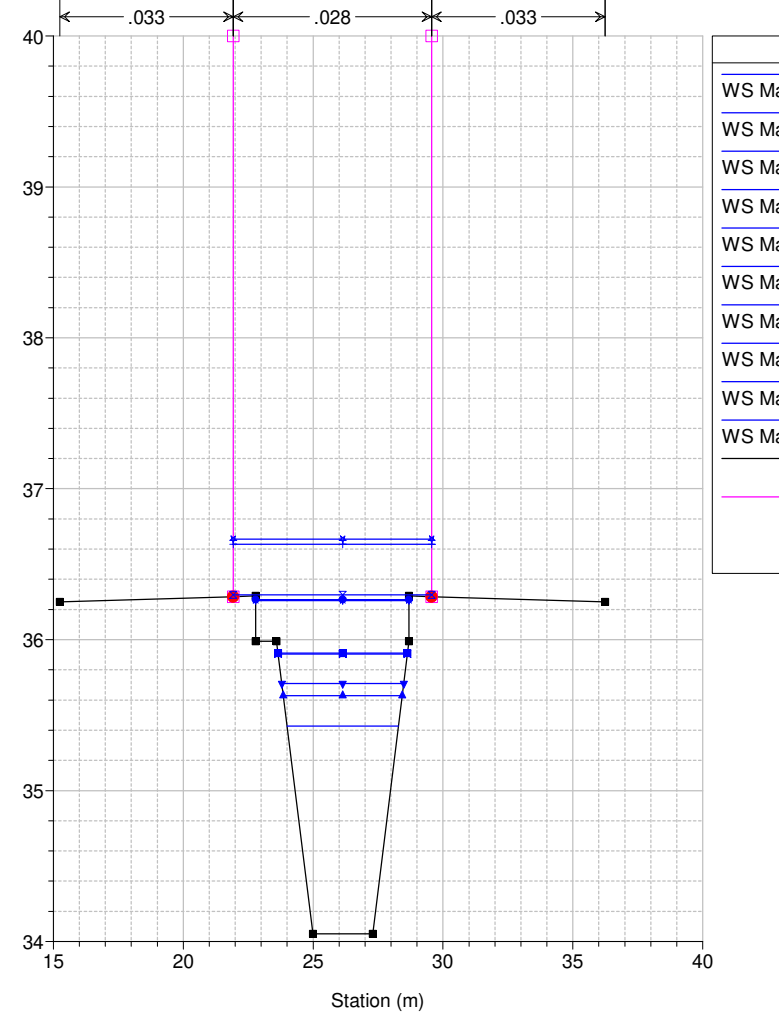

Legend

- WS Max WS - TR200_24_0
- WS Max WS - TR200_18_0
- WS Max WS - TR200_12_0
- WS Max WS - TR200_09_0
- WS Max WS - TR200_36_0
- WS Max WS - TR200_06_0
- WS Max WS - TR200_03_0
- WS Max WS - TR200_01_5
- WS Max WS - TR200_01_0
- WS Max WS - TR200_00_5
- Ground
- Levee
- Bank Sta

Studio Scandicci Torrenti Greve-Vingone
River = Fosso Dogaione Reach = Dogaione RS = 40 DG1011_D

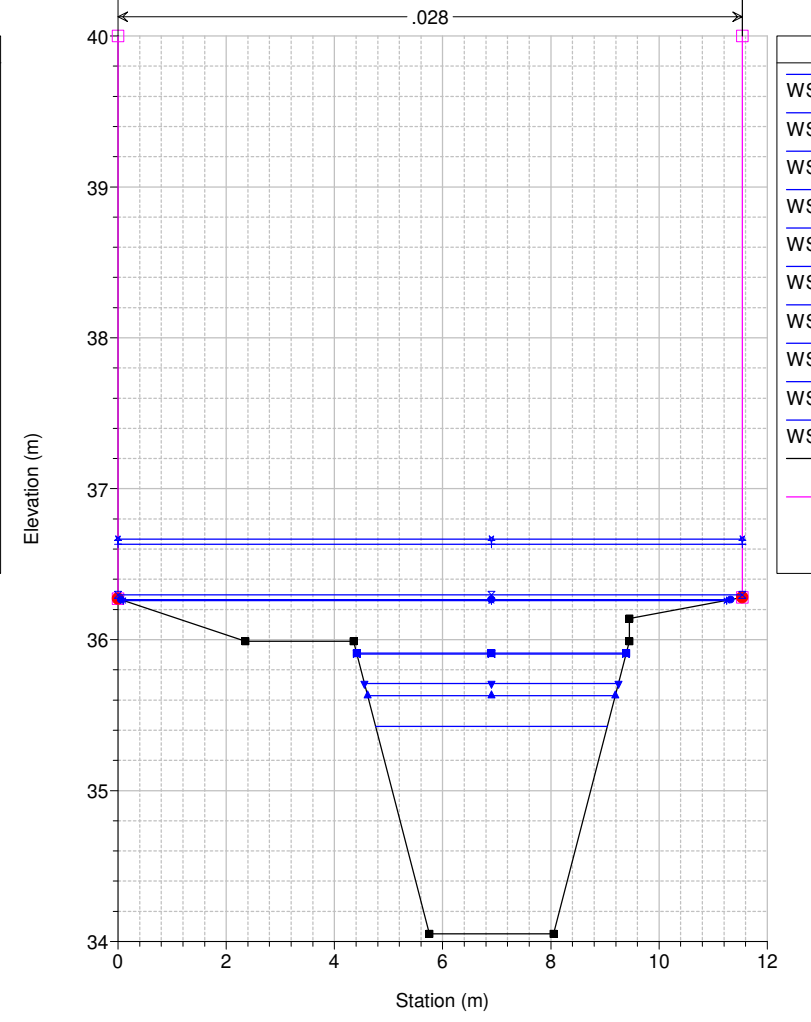

Legend

- WS Max WS - TR200_24_0
- WS Max WS - TR200_18_0
- WS Max WS - TR200_12_0
- WS Max WS - TR200_09_0
- WS Max WS - TR200_36_0
- WS Max WS - TR200_06_0
- WS Max WS - TR200_03_0
- WS Max WS - TR200_01_5
- WS Max WS - TR200_01_0
- WS Max WS - TR200_00_5
- Ground
- Levee
- Bank Sta

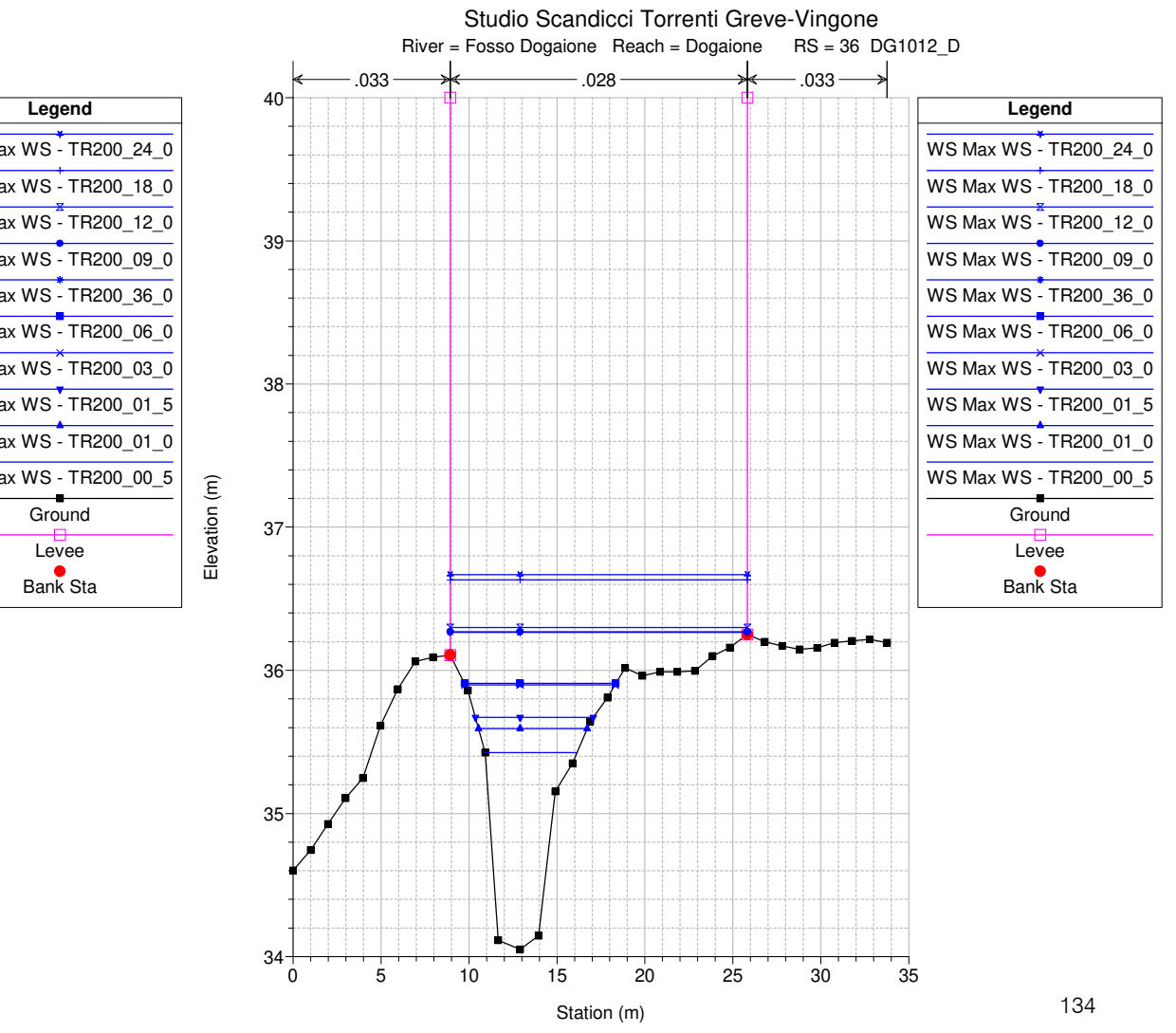
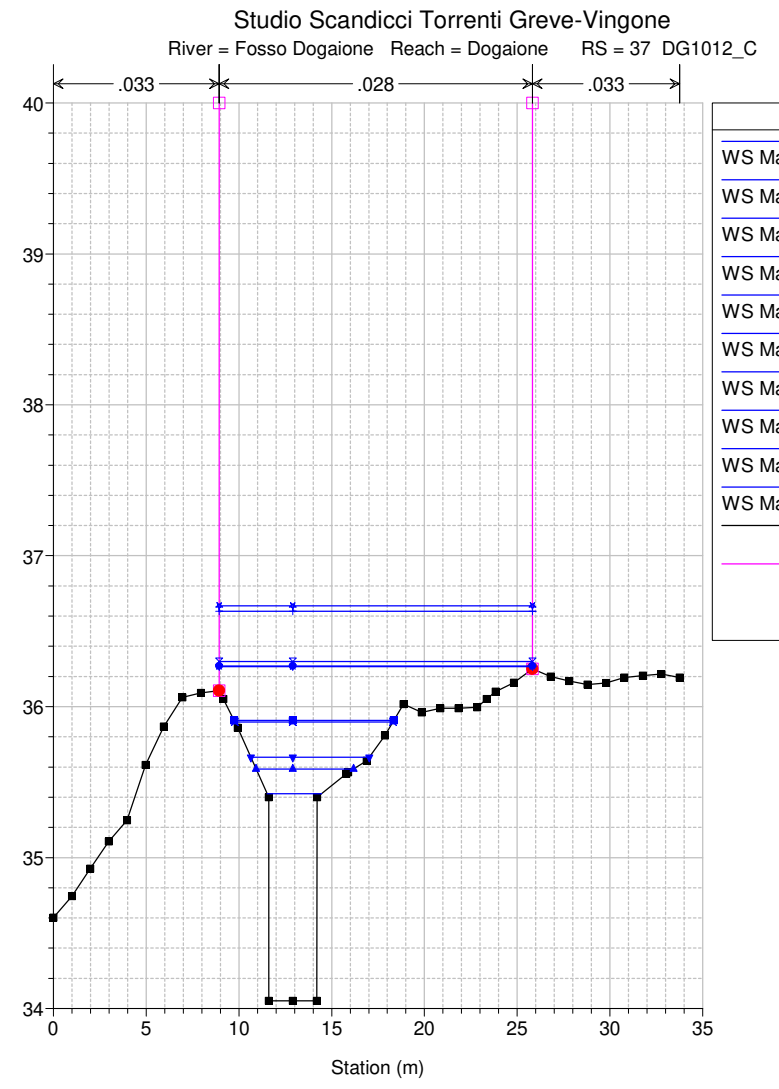
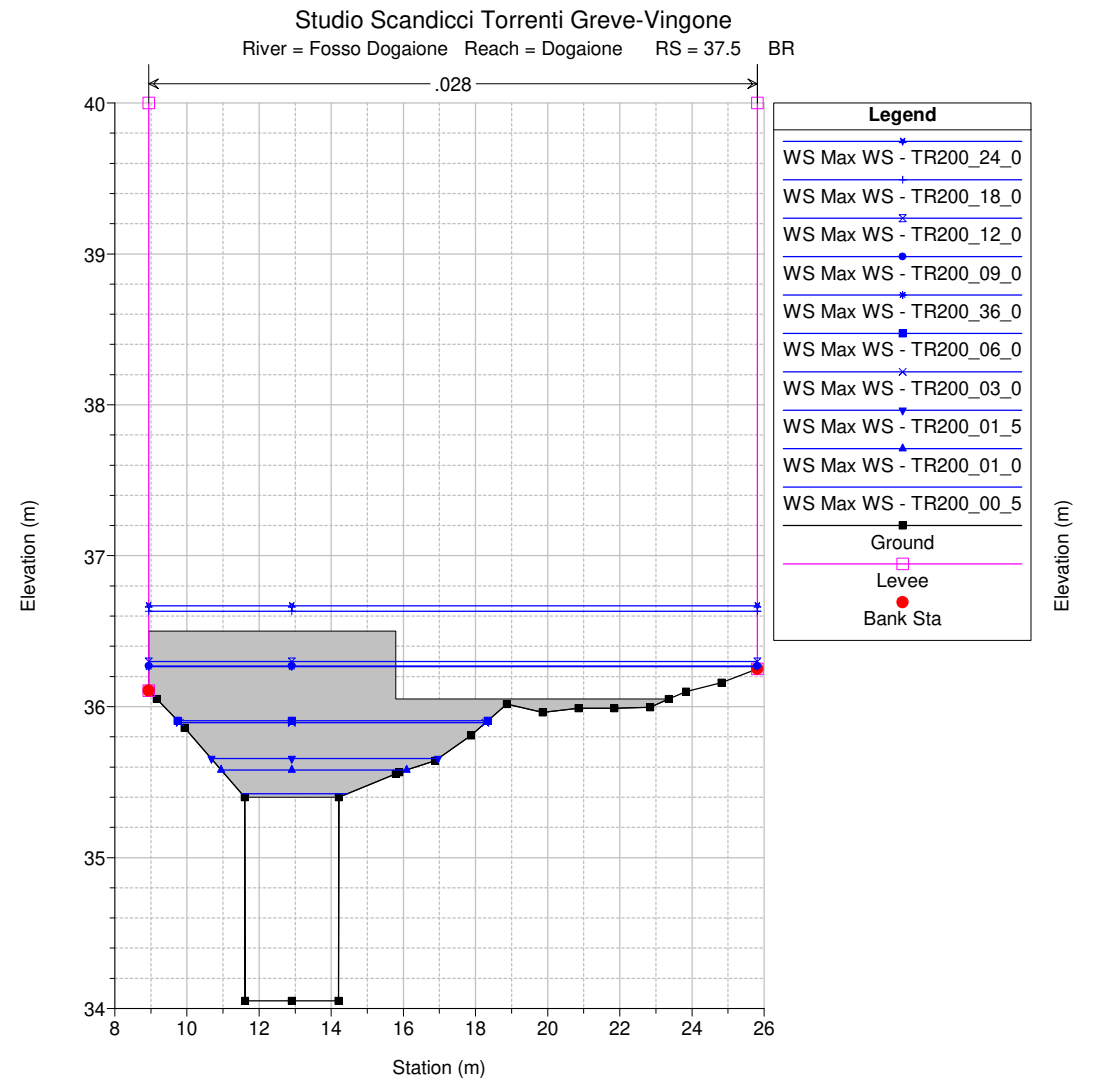
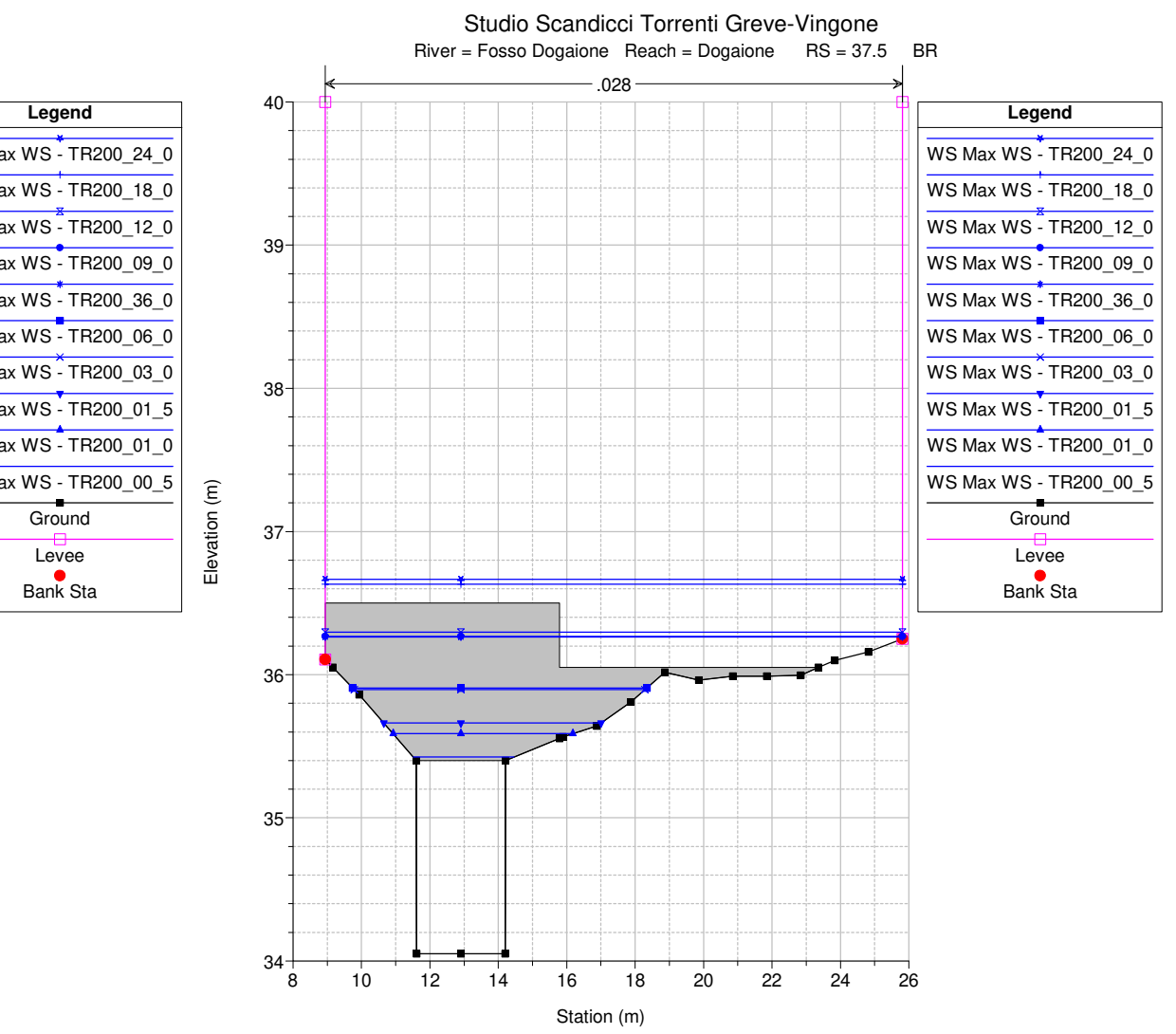
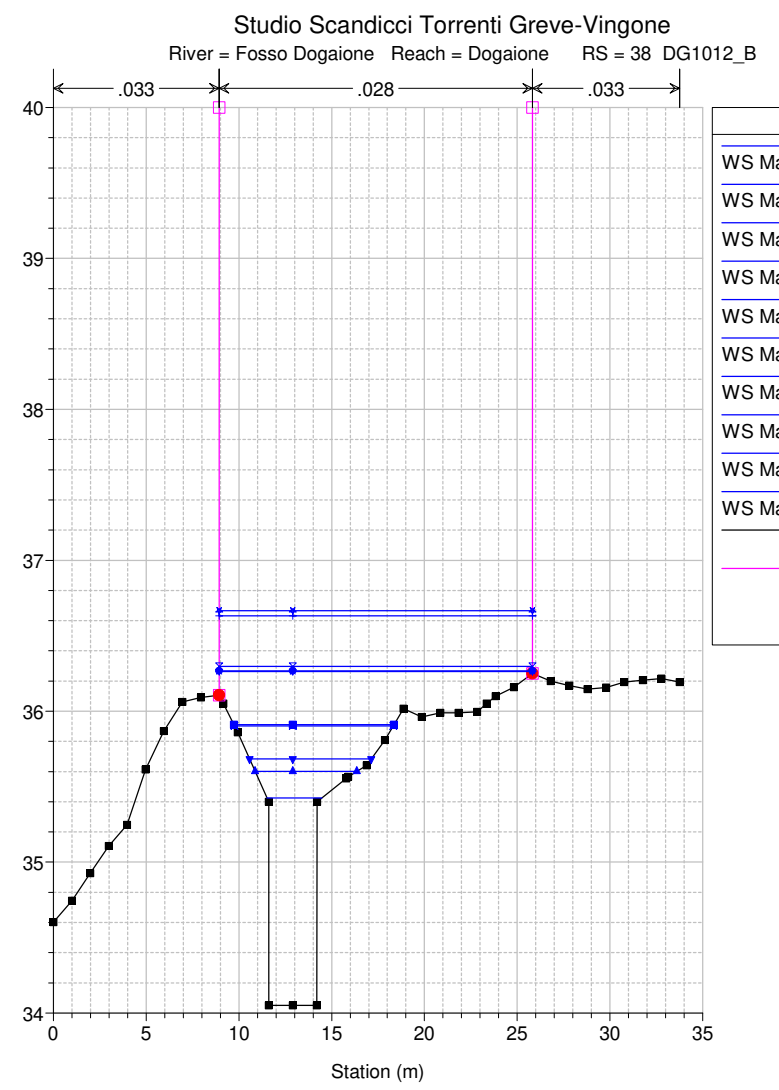
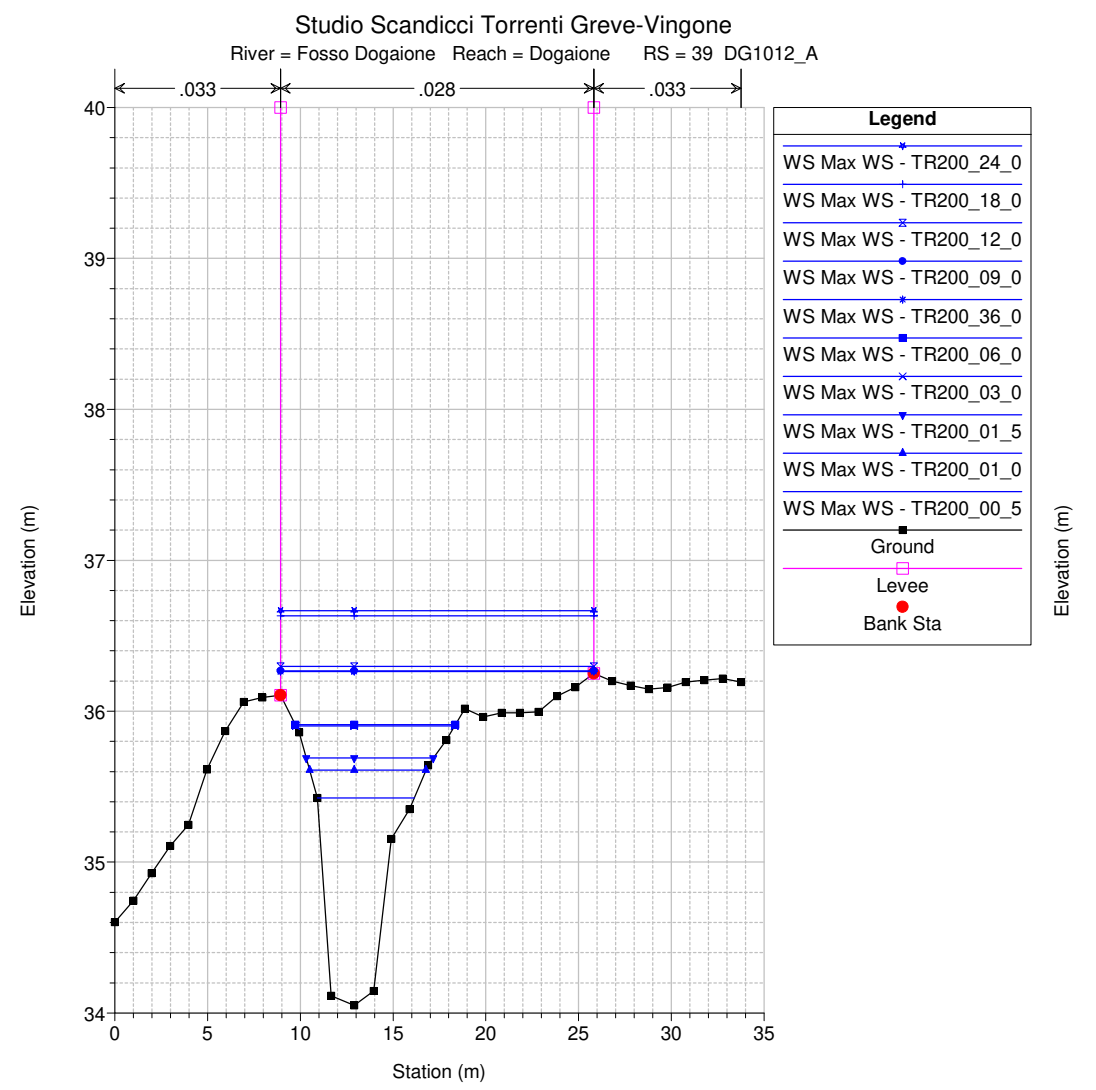

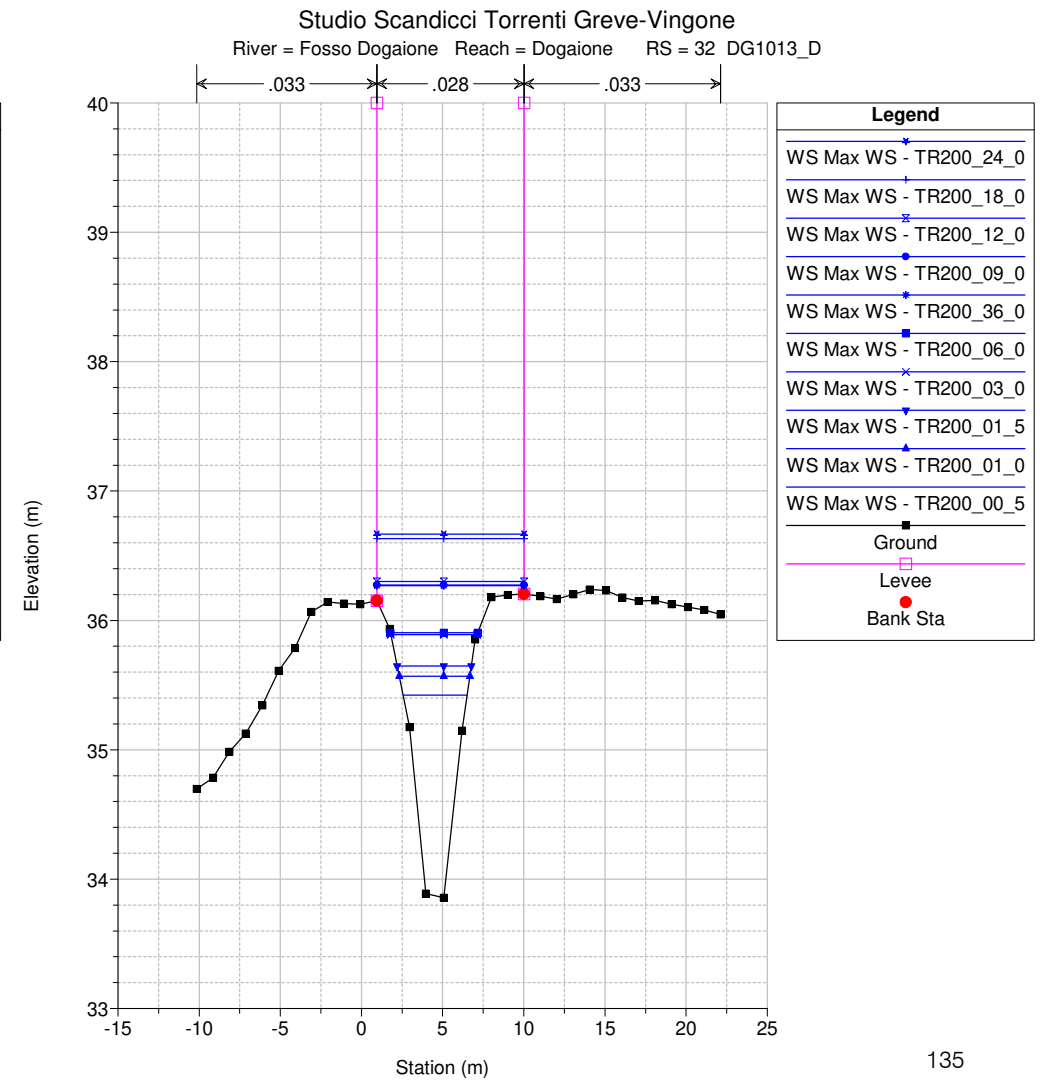
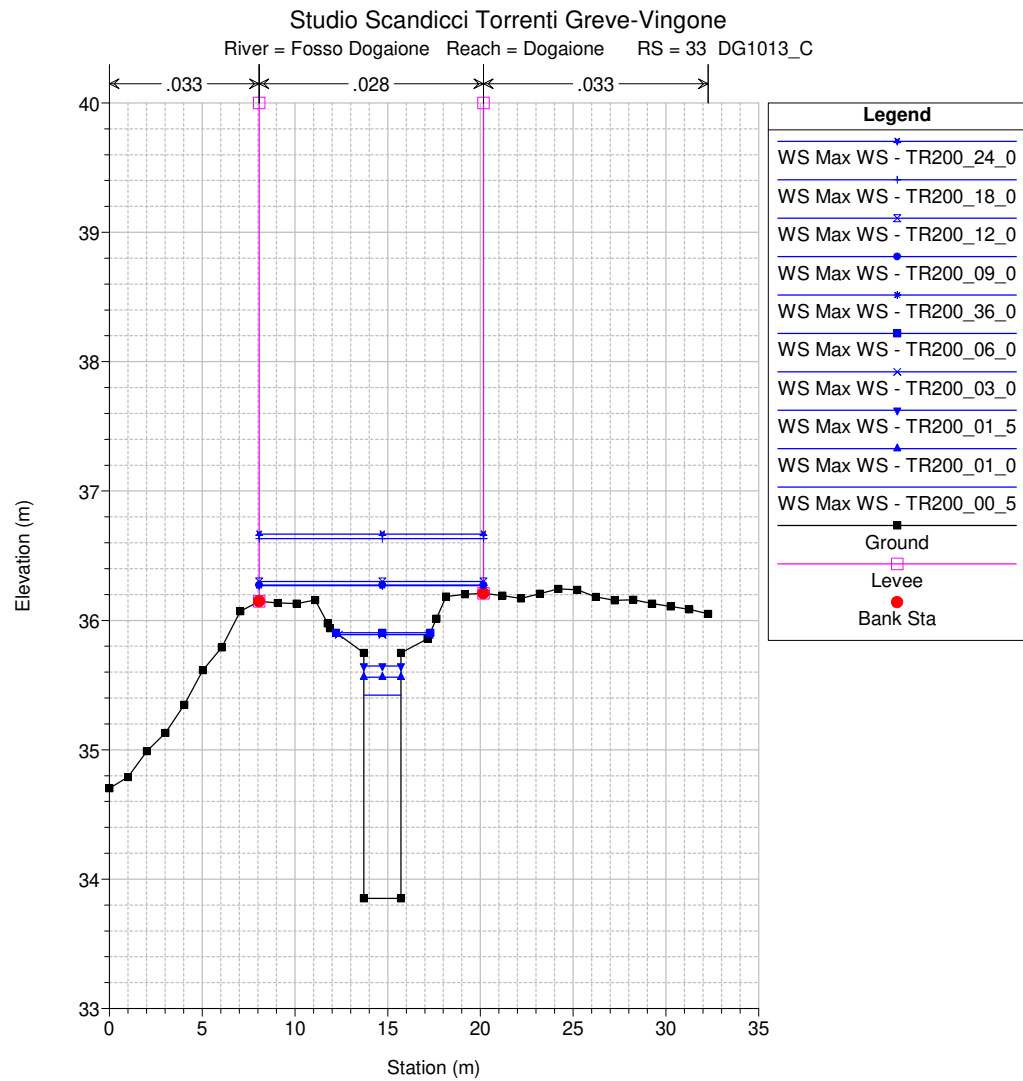
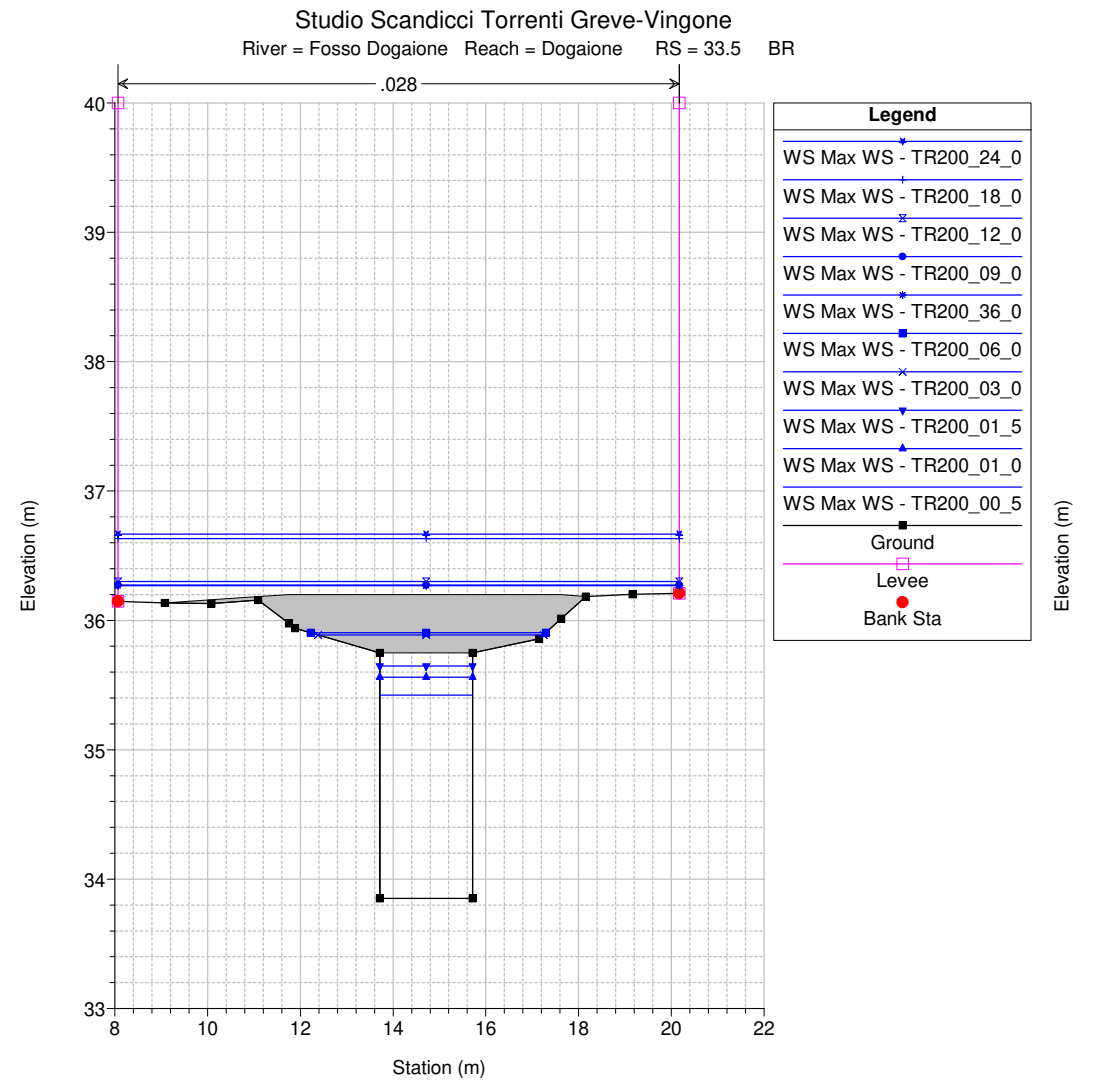
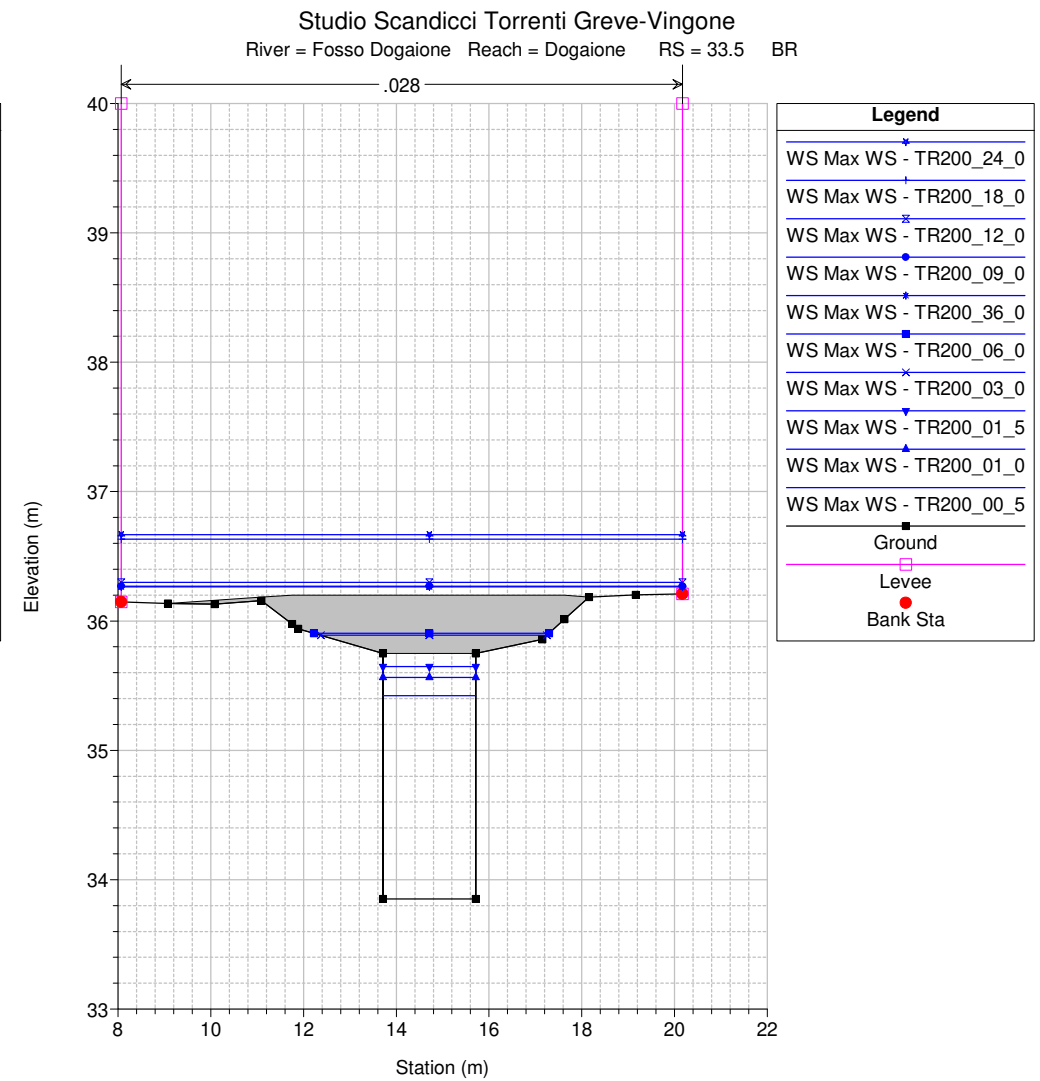
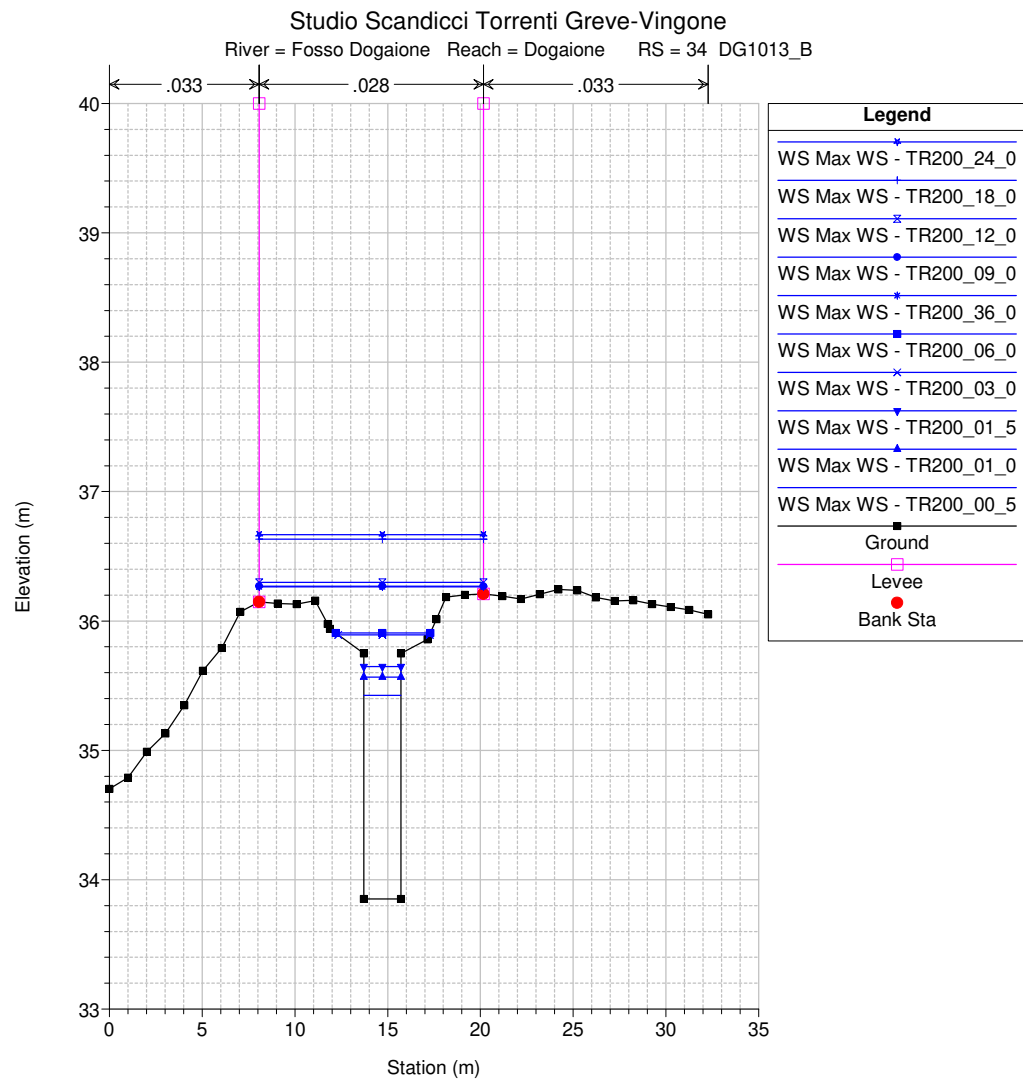
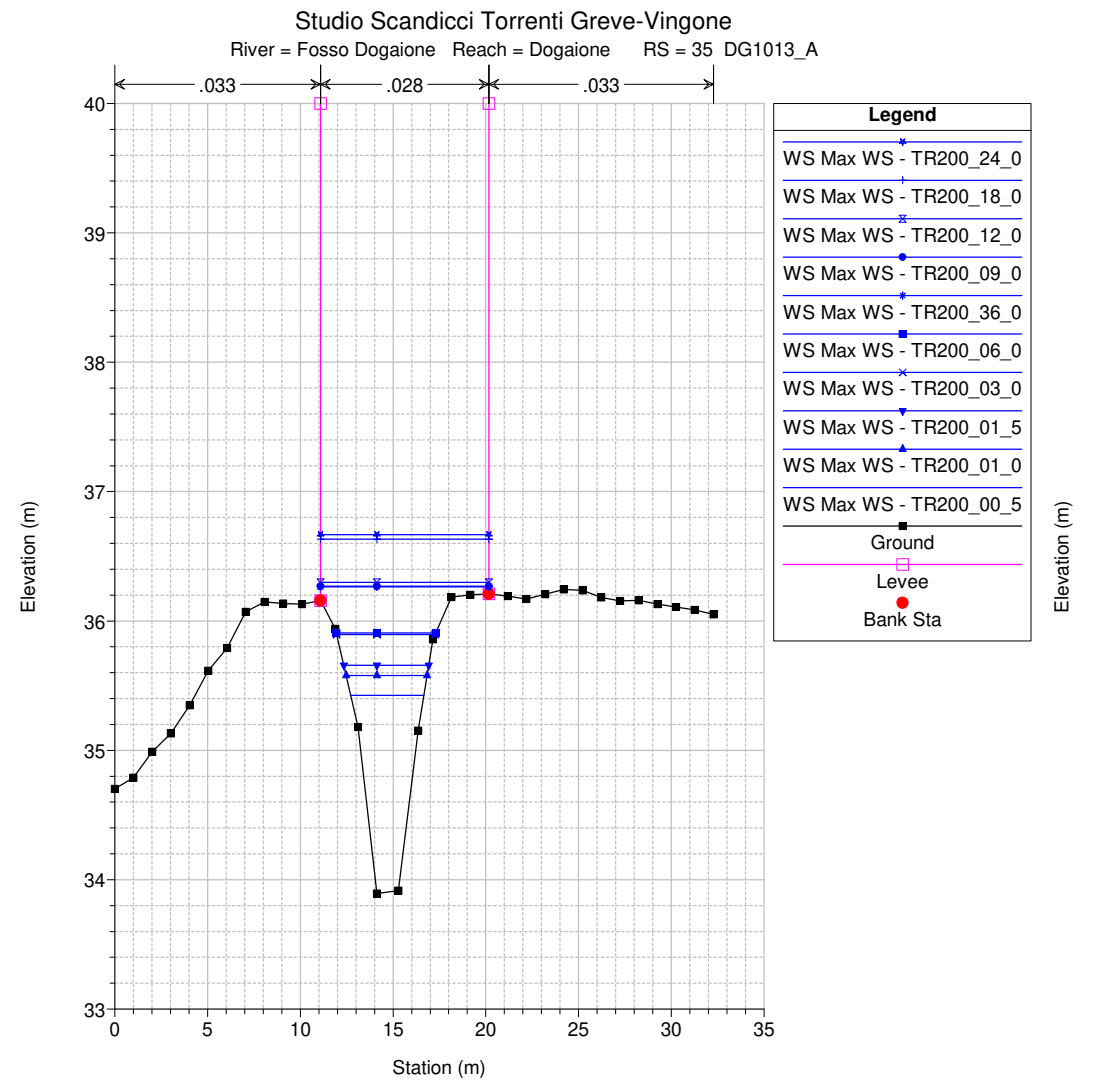

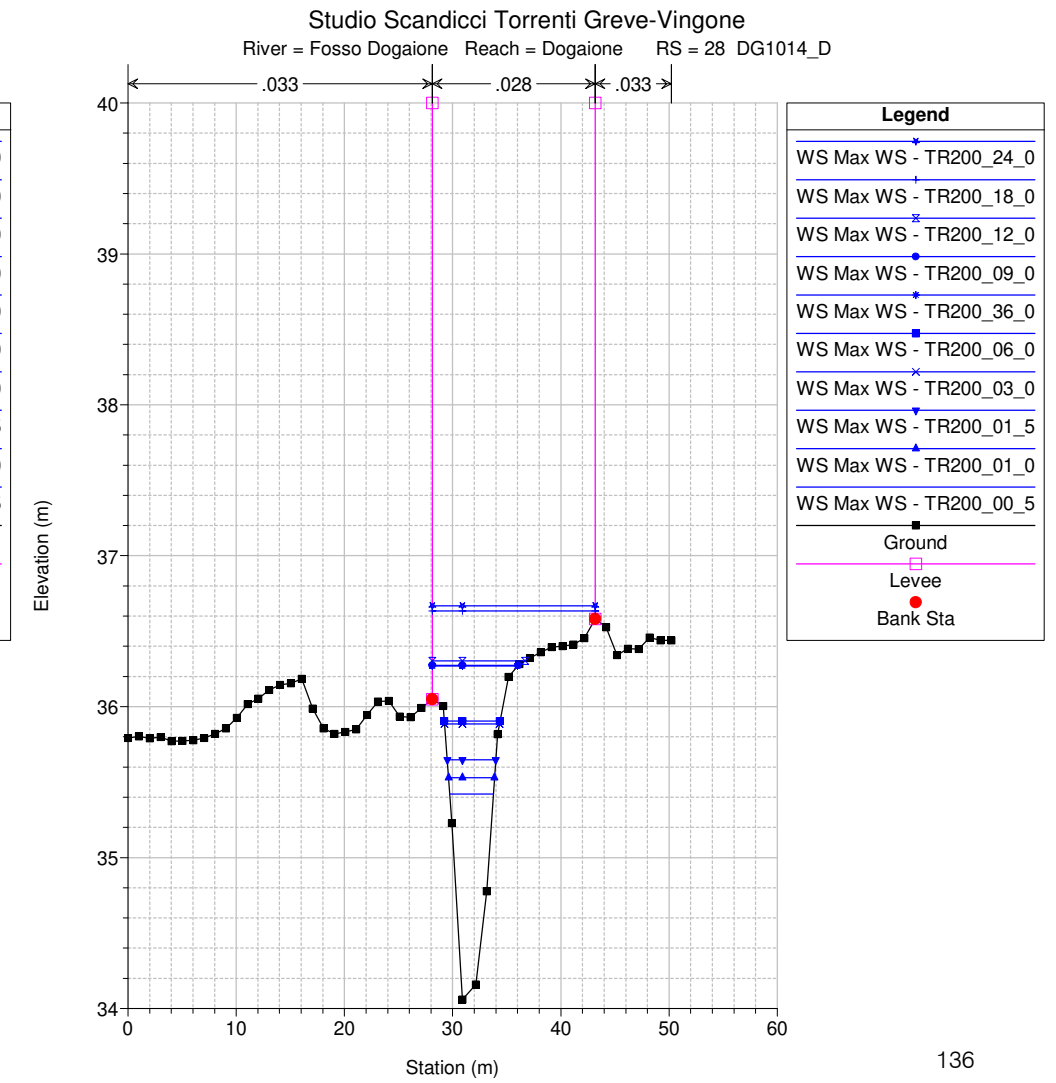
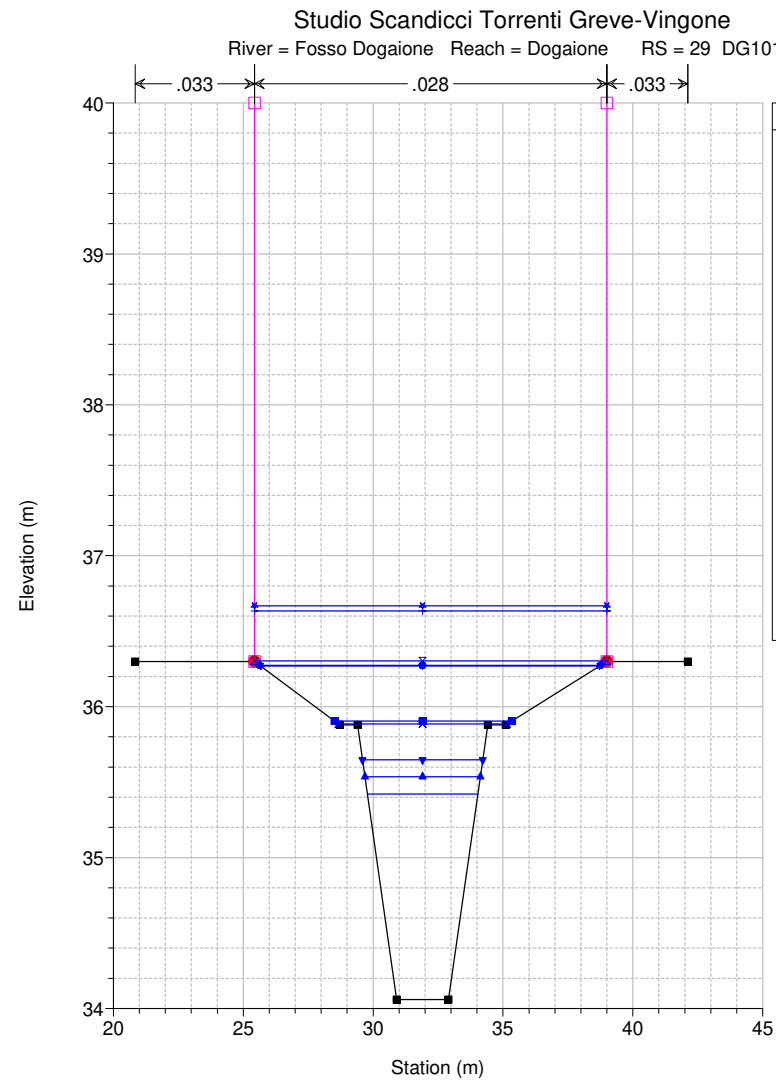
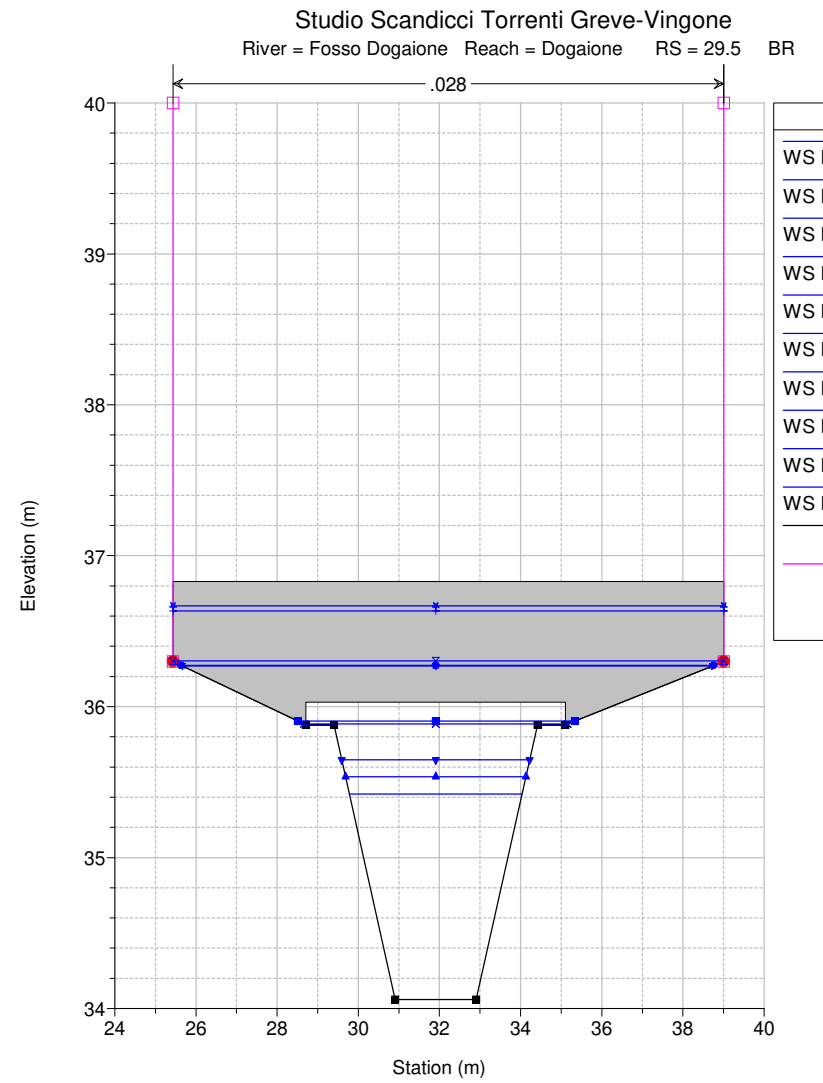
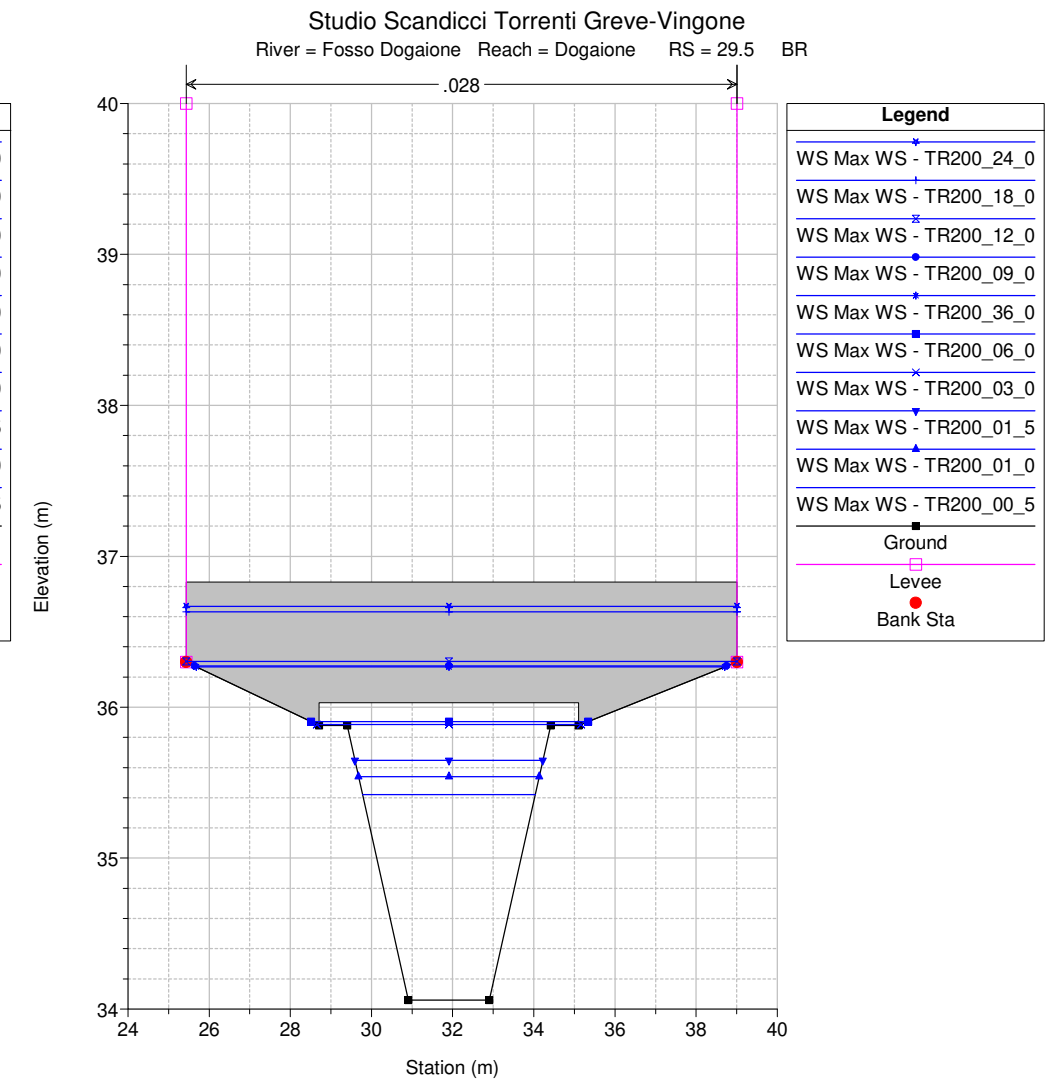
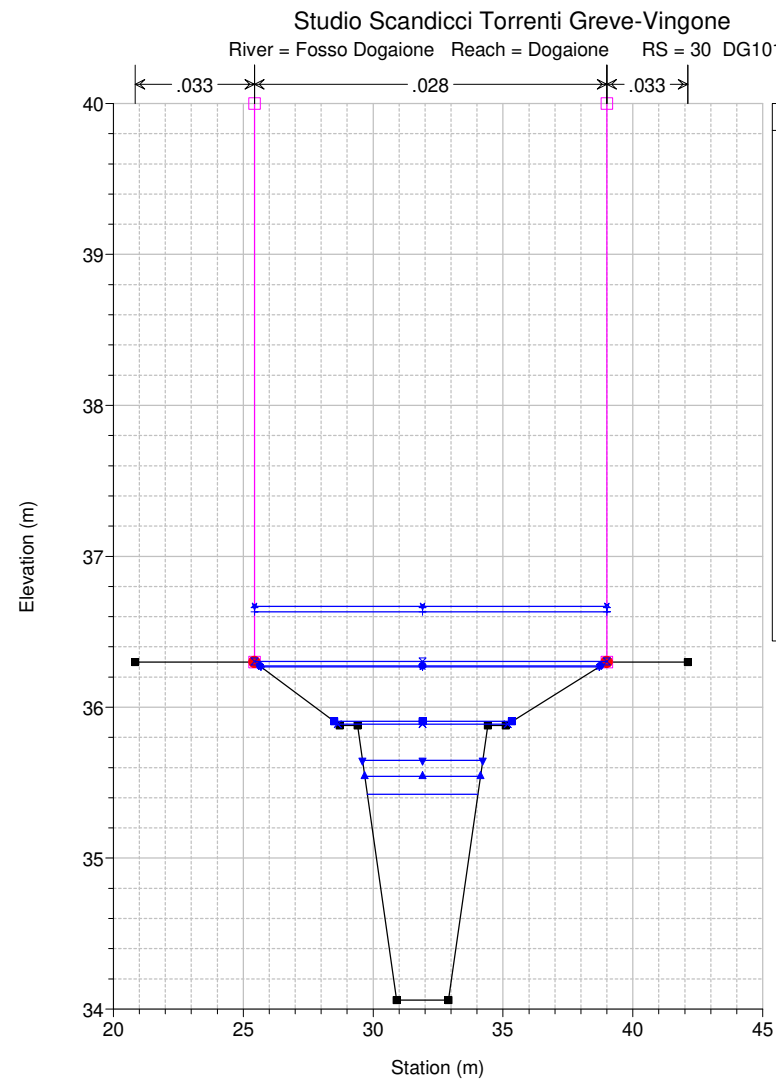
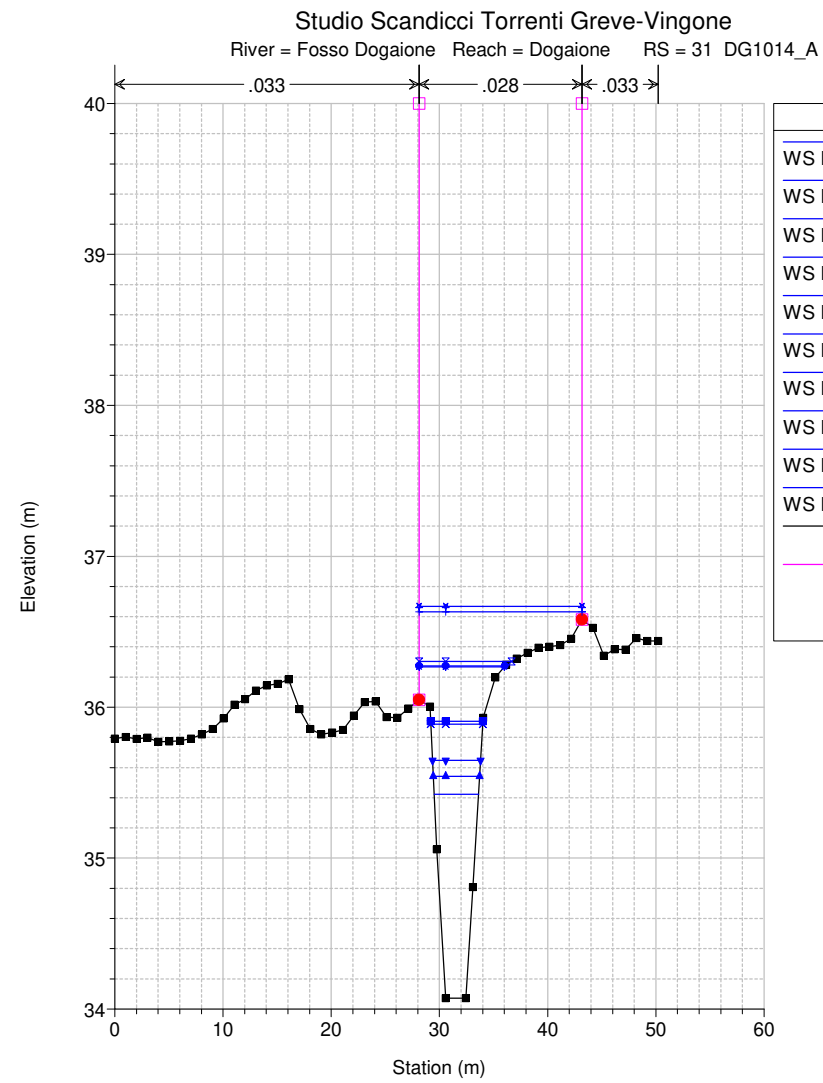

Studio Scandicci Torrenti Greve-Vingone
River = Fosso Dogaione Reach = Dogaione RS = 27 DG1015_A

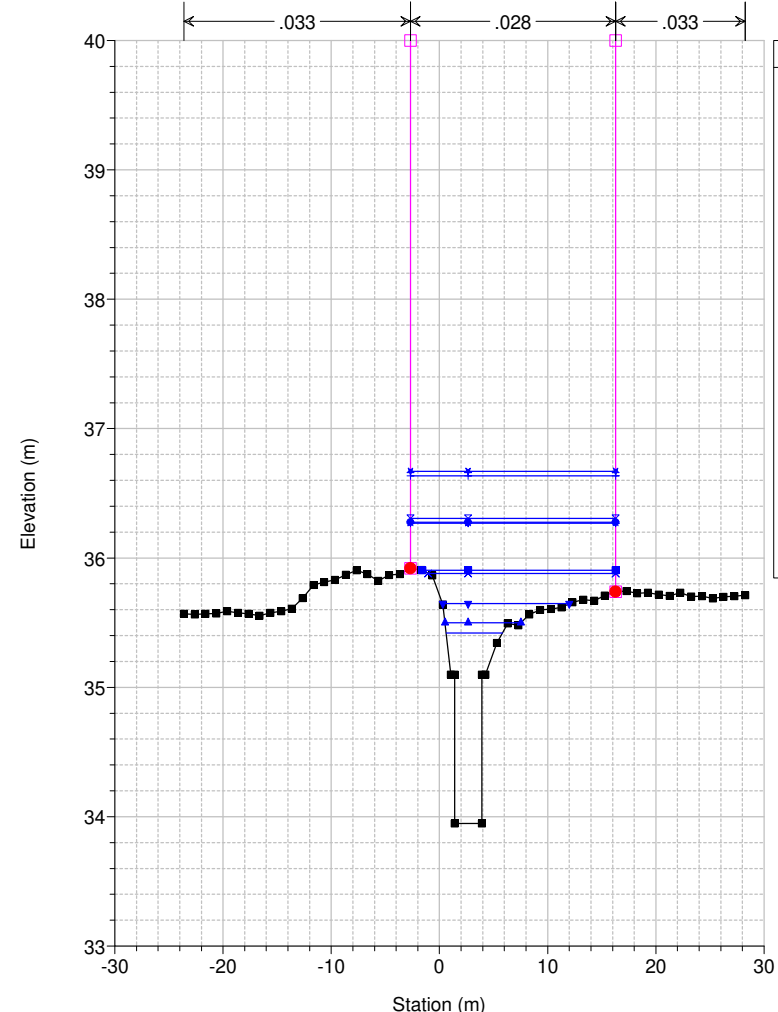

Legend	
WS Max WS - TR200_24_0	▲
WS Max WS - TR200_18_0	+
WS Max WS - TR200_12_0	×
WS Max WS - TR200_09_0	●
WS Max WS - TR200_36_0	■
WS Max WS - TR200_06_0	◆
WS Max WS - TR200_03_0	×
WS Max WS - TR200_01_5	▼
WS Max WS - TR200_01_0	▲
WS Max WS - TR200_00_5	▲
Ground	■
Levee	□
Bank Sta	●

Studio Scandicci Torrenti Greve-Vingone
River = Fosso Dogaione Reach = Dogaione RS = 26 DG1015_B

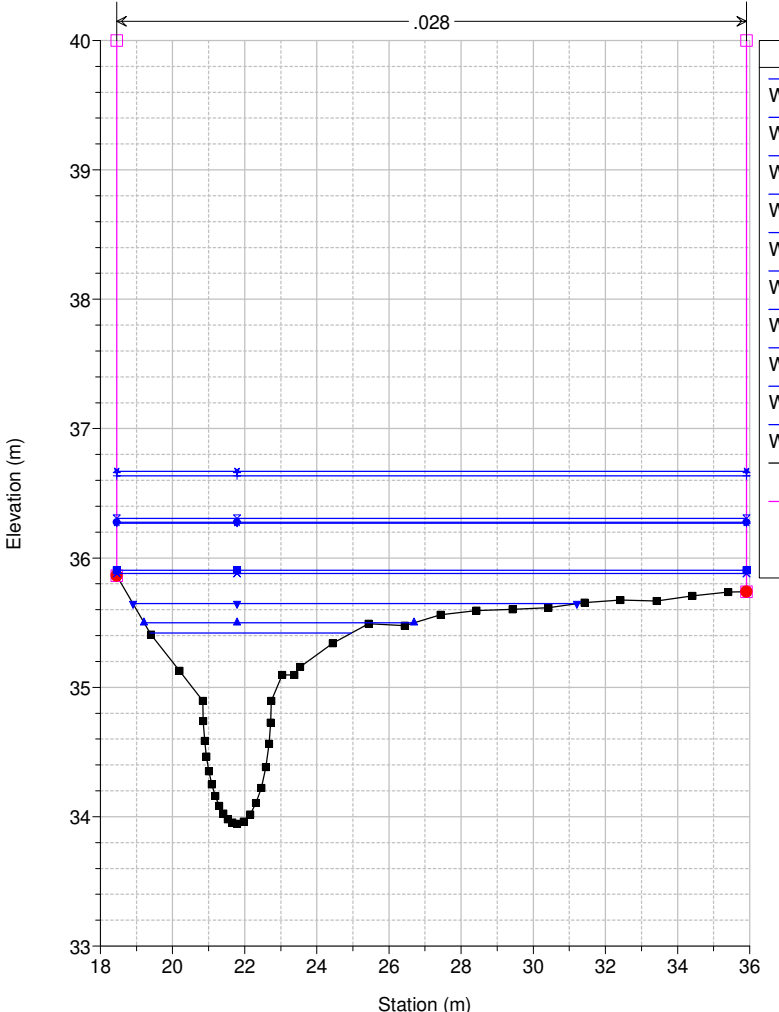

Legend	
WS Max WS - TR200_24_0	▲
WS Max WS - TR200_18_0	+
WS Max WS - TR200_12_0	×
WS Max WS - TR200_09_0	●
WS Max WS - TR200_36_0	■
WS Max WS - TR200_06_0	◆
WS Max WS - TR200_03_0	×
WS Max WS - TR200_01_5	▼
WS Max WS - TR200_01_0	▲
WS Max WS - TR200_00_5	▲
Ground	■
Levee	□
Bank Sta	●

Studio Scandicci Torrenti Greve-Vingone
River = Fosso Dogaione Reach = Dogaione RS = 25 DG1015_C

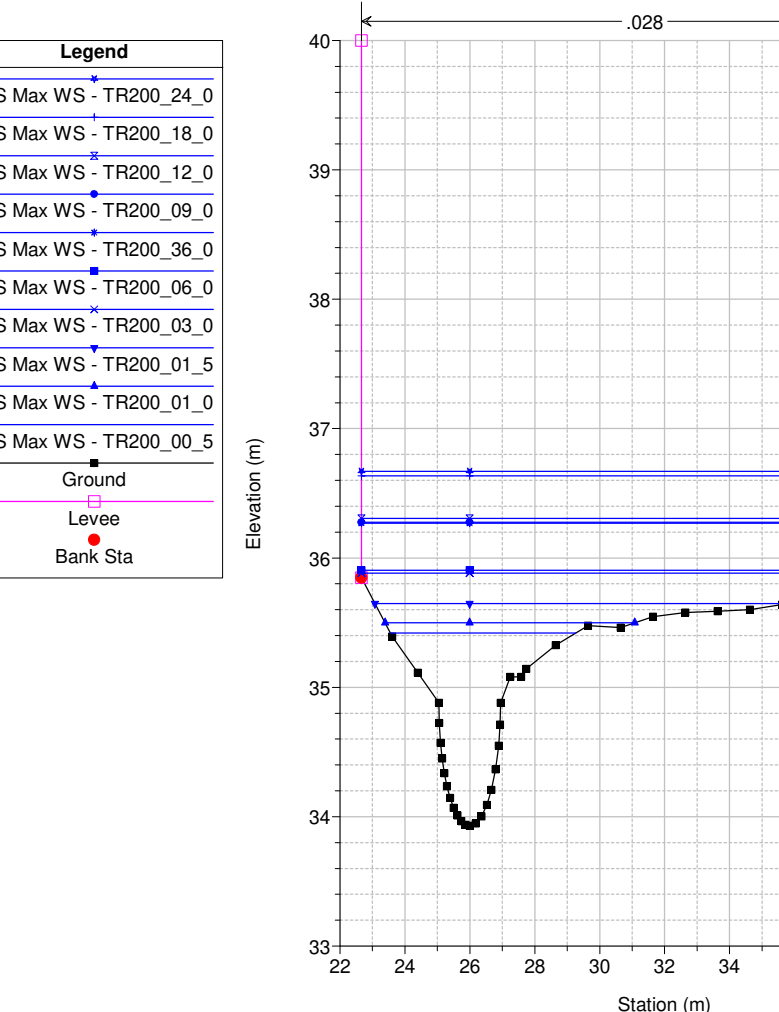

Legend	
WS Max WS - TR200_24_0	▲
WS Max WS - TR200_18_0	+
WS Max WS - TR200_12_0	×
WS Max WS - TR200_09_0	●
WS Max WS - TR200_36_0	■
WS Max WS - TR200_06_0	◆
WS Max WS - TR200_03_0	×
WS Max WS - TR200_01_5	▼
WS Max WS - TR200_01_0	▲
WS Max WS - TR200_00_5	▲
Ground	■
Levee	□
Bank Sta	●

Studio Scandicci Torrenti Greve-Vingone
River = Fosso Dogaione Reach = Dogaione RS = 24 DG1015_D

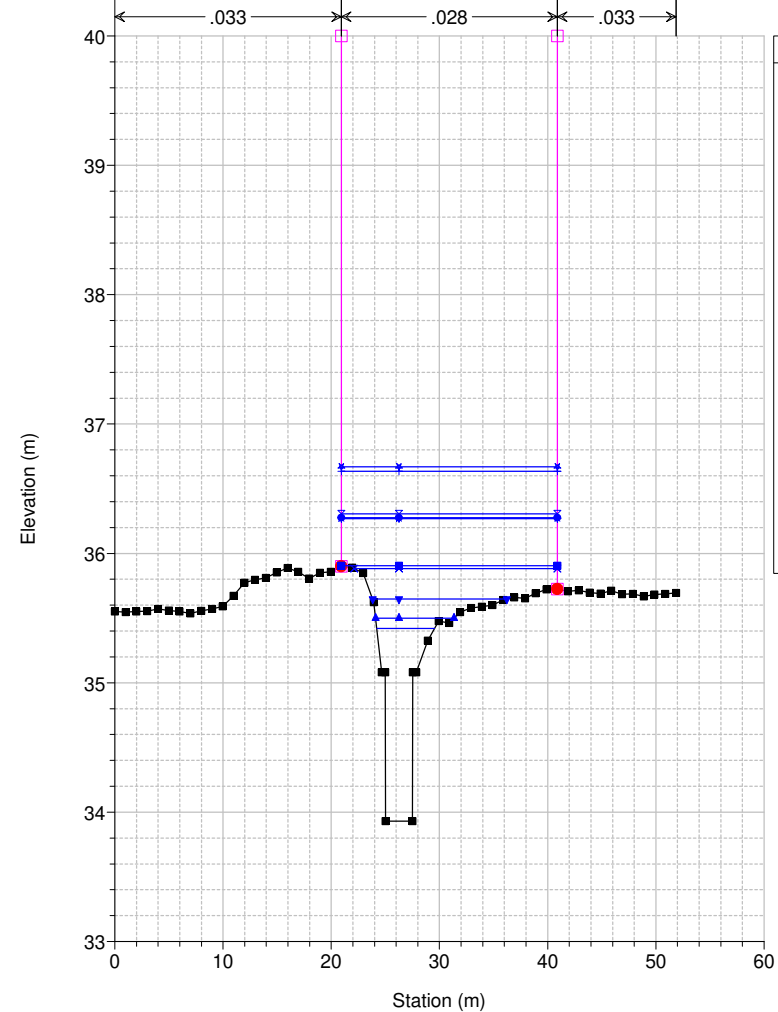

Legend	
WS Max WS - TR200_24_0	▲
WS Max WS - TR200_18_0	+
WS Max WS - TR200_12_0	×
WS Max WS - TR200_09_0	●
WS Max WS - TR200_36_0	■
WS Max WS - TR200_06_0	◆
WS Max WS - TR200_03_0	×
WS Max WS - TR200_01_5	▼
WS Max WS - TR200_01_0	▲
WS Max WS - TR200_00_5	▲
Ground	■
Levee	□
Bank Sta	●

Studio Scandicci Torrenti Greve-Vingone
River = Fosso Dogaione Reach = Dogaione RS = 23 DG0013_A

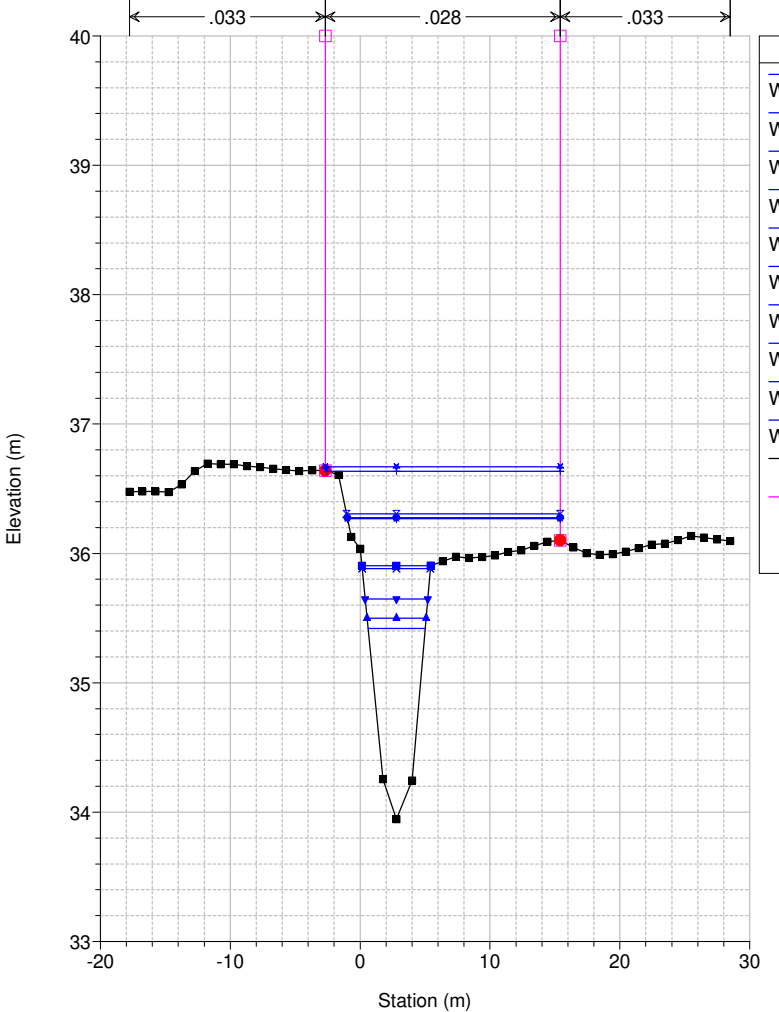

Legend	
WS Max WS - TR200_24_0	▲
WS Max WS - TR200_18_0	+
WS Max WS - TR200_12_0	×
WS Max WS - TR200_09_0	●
WS Max WS - TR200_36_0	■
WS Max WS - TR200_06_0	◆
WS Max WS - TR200_03_0	×
WS Max WS - TR200_01_5	▼
WS Max WS - TR200_01_0	▲
WS Max WS - TR200_00_5	▲
Ground	■
Levee	□
Bank Sta	●

Studio Scandicci Torrenti Greve-Vingone
River = Fosso Dogaione Reach = Dogaione RS = 22 DG0013_B

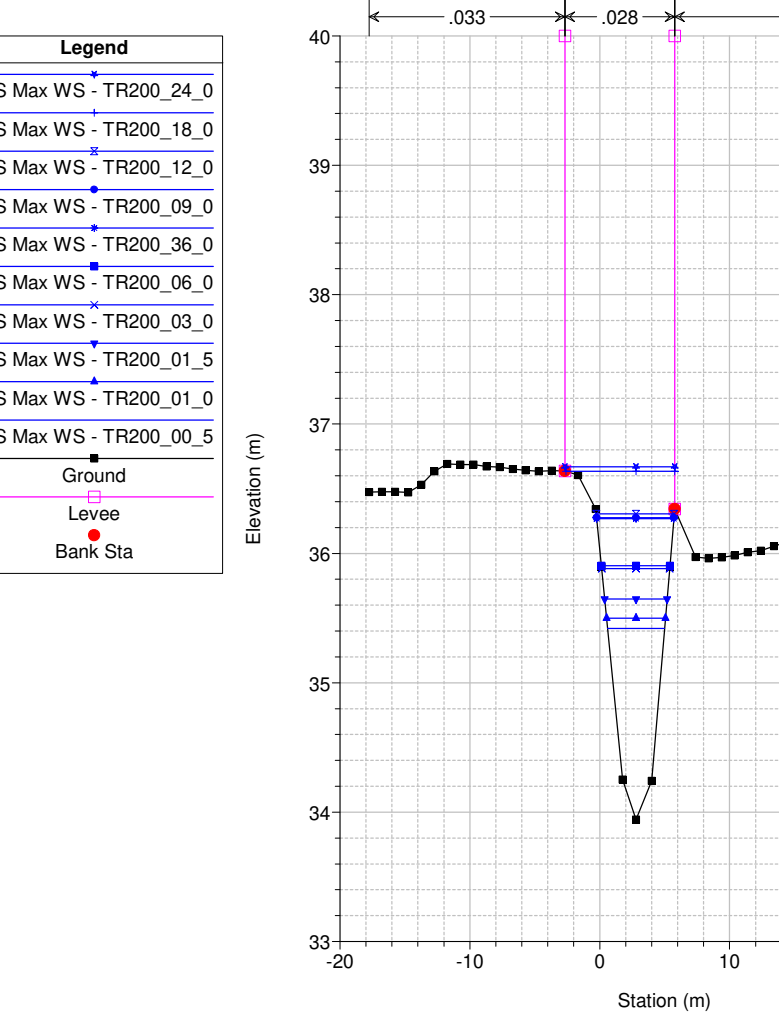

Legend	
WS Max WS - TR200_24_0	▲
WS Max WS - TR200_18_0	+
WS Max WS - TR200_12_0	×
WS Max WS - TR200_09_0	●
WS Max WS - TR200_36_0	■
WS Max WS - TR200_06_0	◆
WS Max WS - TR200_03_0	×
WS Max WS - TR200_01_5	▼
WS Max WS - TR200_01_0	▲
WS Max WS - TR200_00_5	▲
Ground	■
Levee	□
Bank Sta	●

Studio Scandicci Torrenti Greve-Vingone
River = Fosso Dogaione Reach = Dogaione RS = 21.5 BR

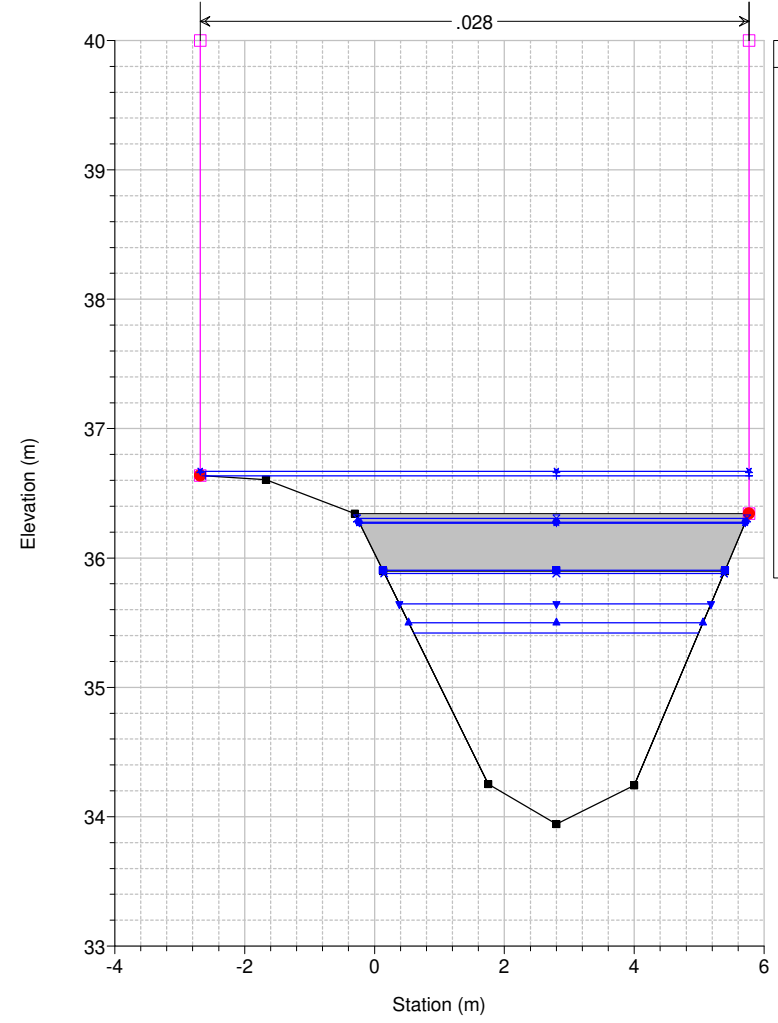

Legend	
WS Max WS - TR200_24_0	+
WS Max WS - TR200_18_0	+
WS Max WS - TR200_12_0	+
WS Max WS - TR200_09_0	+
WS Max WS - TR200_36_0	+
WS Max WS - TR200_06_0	+
WS Max WS - TR200_03_0	+
WS Max WS - TR200_01_5	+
WS Max WS - TR200_01_0	+
WS Max WS - TR200_00_5	+
Ground	■
Levee	□
Bank Sta	●

Studio Scandicci Torrenti Greve-Vingone
River = Fosso Dogaione Reach = Dogaione RS = 21.5 BR

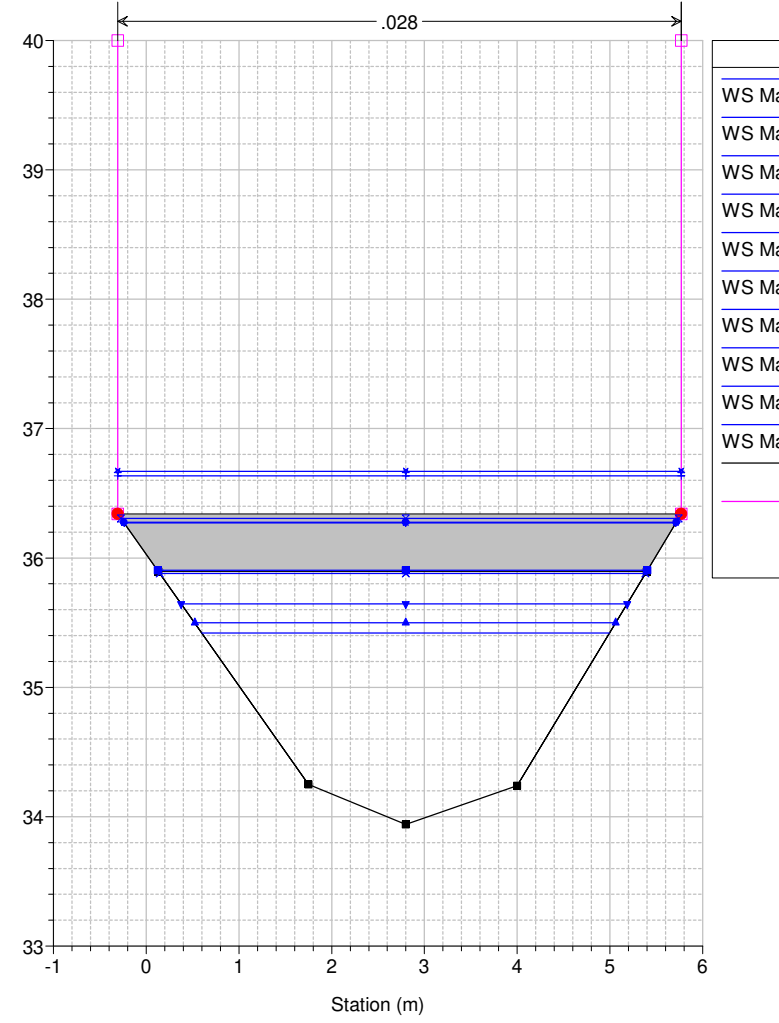

Legend	
WS Max WS - TR200_24_0	+
WS Max WS - TR200_18_0	+
WS Max WS - TR200_12_0	+
WS Max WS - TR200_09_0	+
WS Max WS - TR200_36_0	+
WS Max WS - TR200_06_0	+
WS Max WS - TR200_03_0	+
WS Max WS - TR200_01_5	+
WS Max WS - TR200_01_0	+
WS Max WS - TR200_00_5	+
Ground	■
Levee	□
Bank Sta	●

Studio Scandicci Torrenti Greve-Vingone
River = Fosso Dogaione Reach = Dogaione RS = 21 DG0013_C

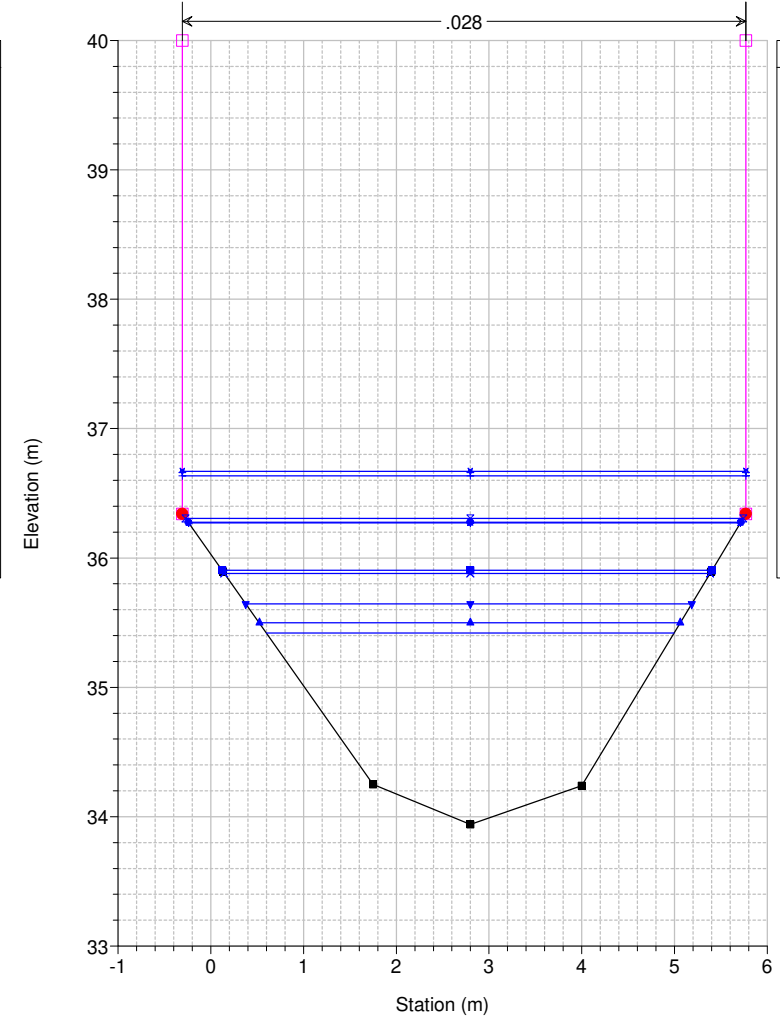

Legend	
WS Max WS - TR200_24_0	+
WS Max WS - TR200_18_0	+
WS Max WS - TR200_12_0	+
WS Max WS - TR200_09_0	+
WS Max WS - TR200_36_0	+
WS Max WS - TR200_06_0	+
WS Max WS - TR200_03_0	+
WS Max WS - TR200_01_5	+
WS Max WS - TR200_01_0	+
WS Max WS - TR200_00_5	+
Ground	■
Levee	□
Bank Sta	●

Studio Scandicci Torrenti Greve-Vingone
River = Fosso Dogaione Reach = Dogaione RS = 20 DG0013_D

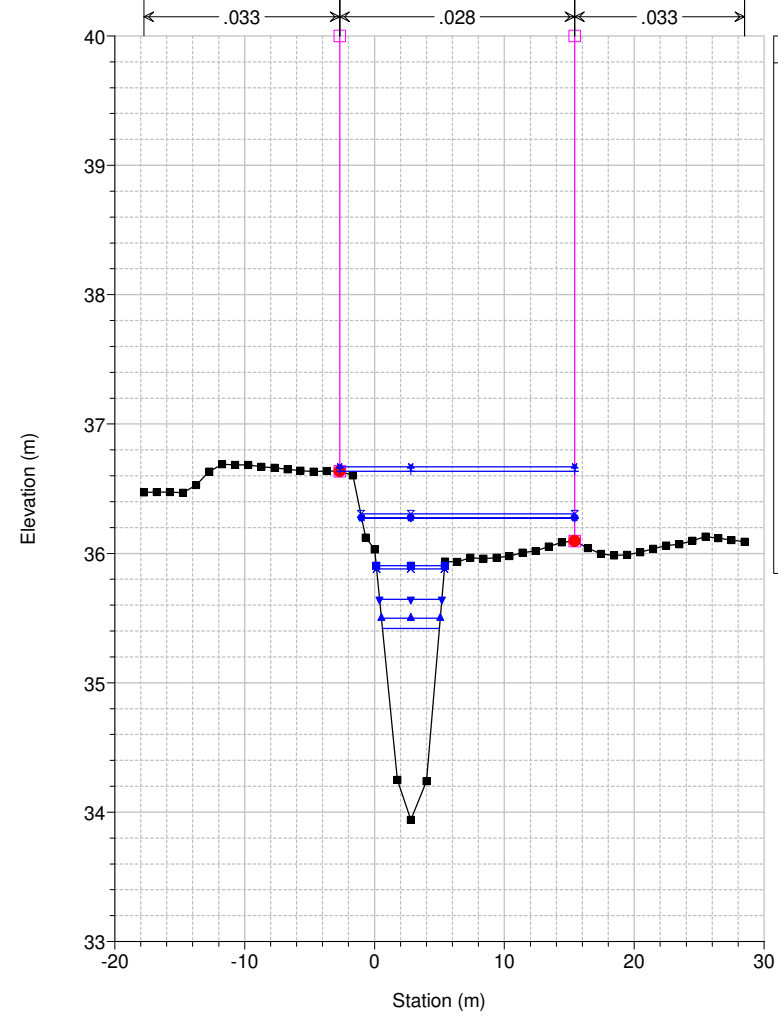

Legend	
WS Max WS - TR200_24_0	+
WS Max WS - TR200_18_0	+
WS Max WS - TR200_12_0	+
WS Max WS - TR200_09_0	+
WS Max WS - TR200_36_0	+
WS Max WS - TR200_06_0	+
WS Max WS - TR200_03_0	+
WS Max WS - TR200_01_5	+
WS Max WS - TR200_01_0	+
WS Max WS - TR200_00_5	+
Ground	■
Levee	□
Bank Sta	●

Studio Scandicci Torrenti Greve-Vingone
River = Fosso Dogaione Reach = Dogaione RS = 19 DG0014_A

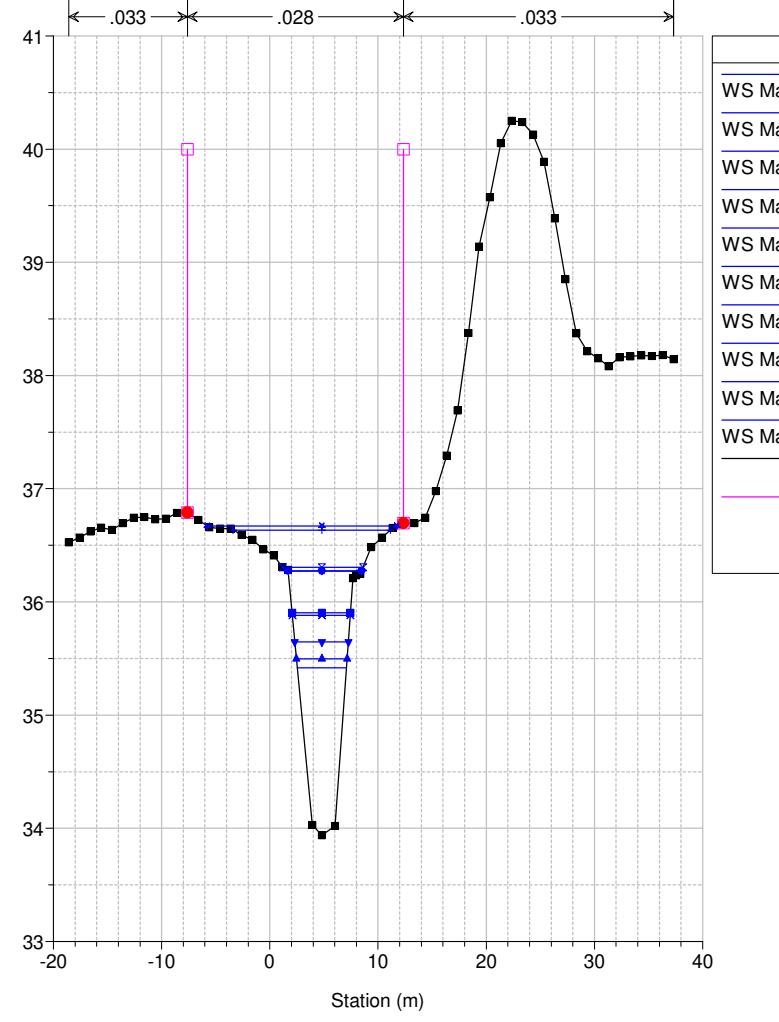

Legend	
WS Max WS - TR200_24_0	+
WS Max WS - TR200_18_0	+
WS Max WS - TR200_12_0	+
WS Max WS - TR200_09_0	+
WS Max WS - TR200_36_0	+
WS Max WS - TR200_06_0	+
WS Max WS - TR200_03_0	+
WS Max WS - TR200_01_5	+
WS Max WS - TR200_01_0	+
WS Max WS - TR200_00_5	+
Ground	■
Levee	□
Bank Sta	●

Studio Scandicci Torrenti Greve-Vingone
River = Fosso Dogaione Reach = Dogaione RS = 18 DG0014_B

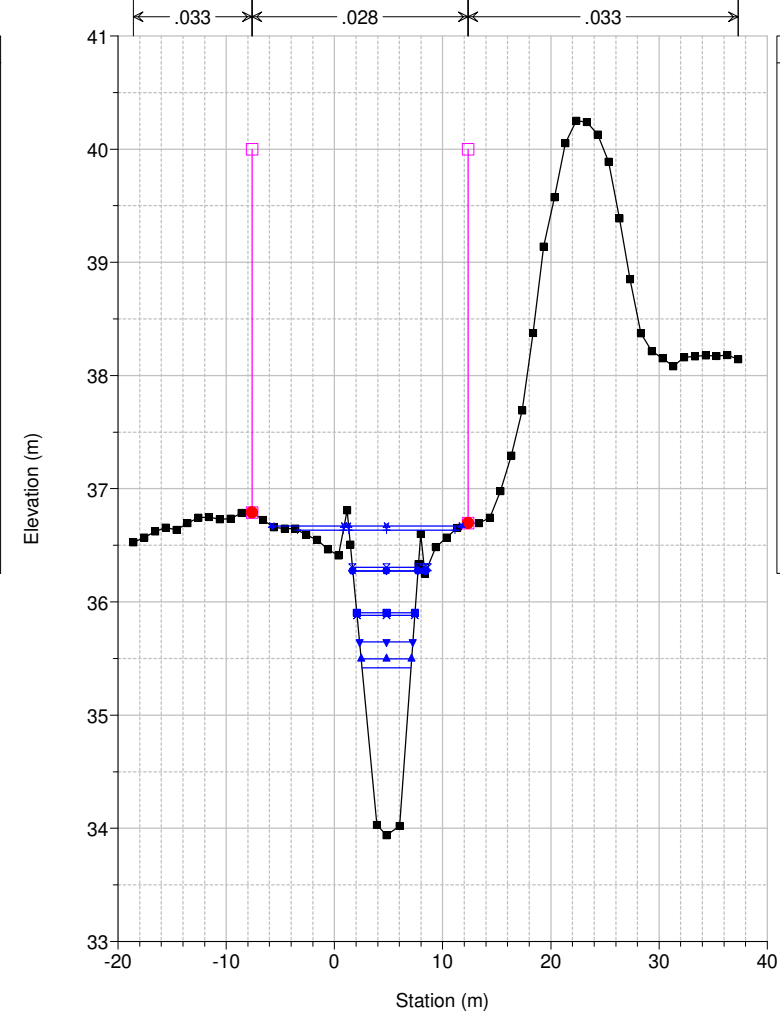

Legend	
WS Max WS - TR200_24_0	+
WS Max WS - TR200_18_0	+
WS Max WS - TR200_12_0	+
WS Max WS - TR200_09_0	+
WS Max WS - TR200_36_0	+
WS Max WS - TR200_06_0	+
WS Max WS - TR200_03_0	+
WS Max WS - TR200_01_5	+
WS Max WS - TR200_01_0	+
WS Max WS - TR200_00_5	+
Ground	■
Levee	□
Bank Sta	●

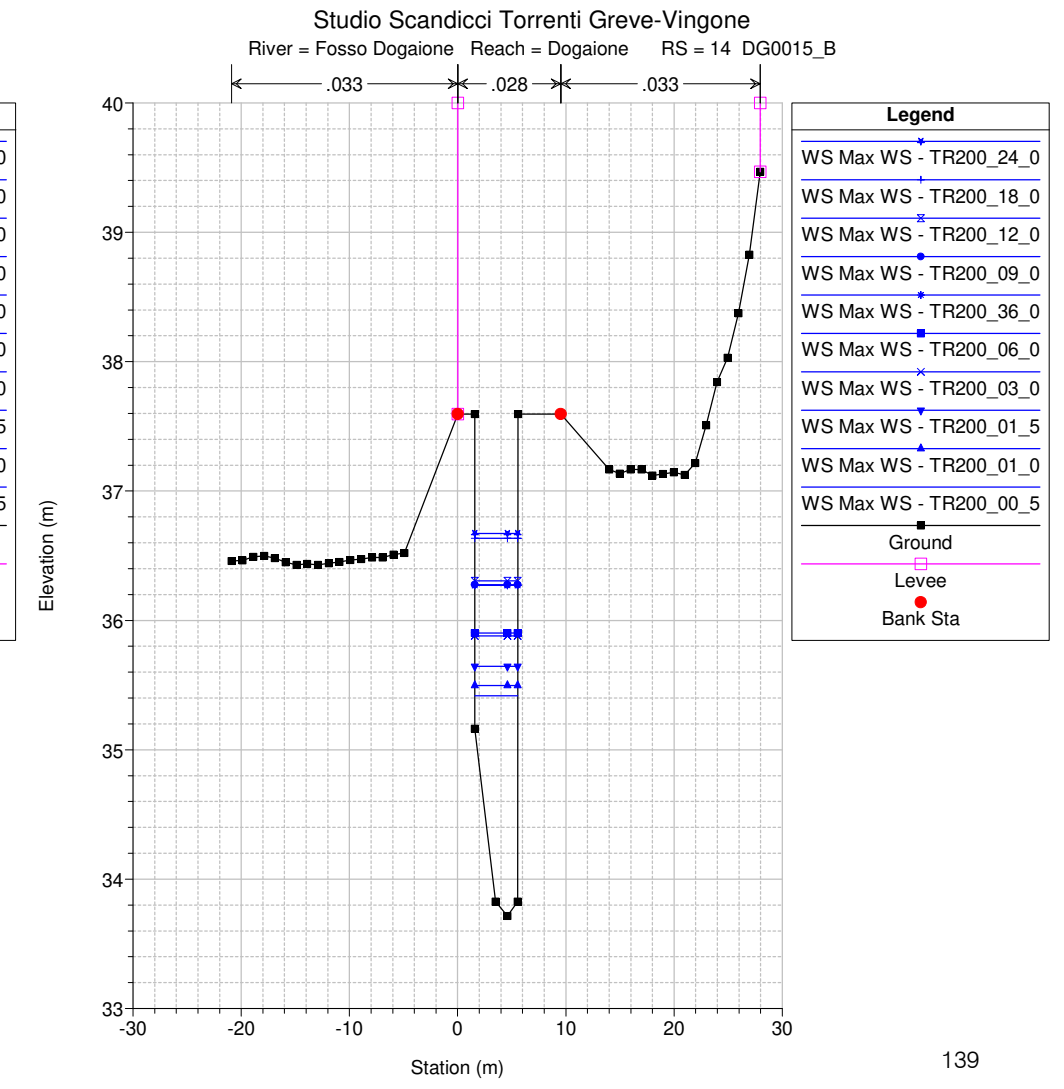
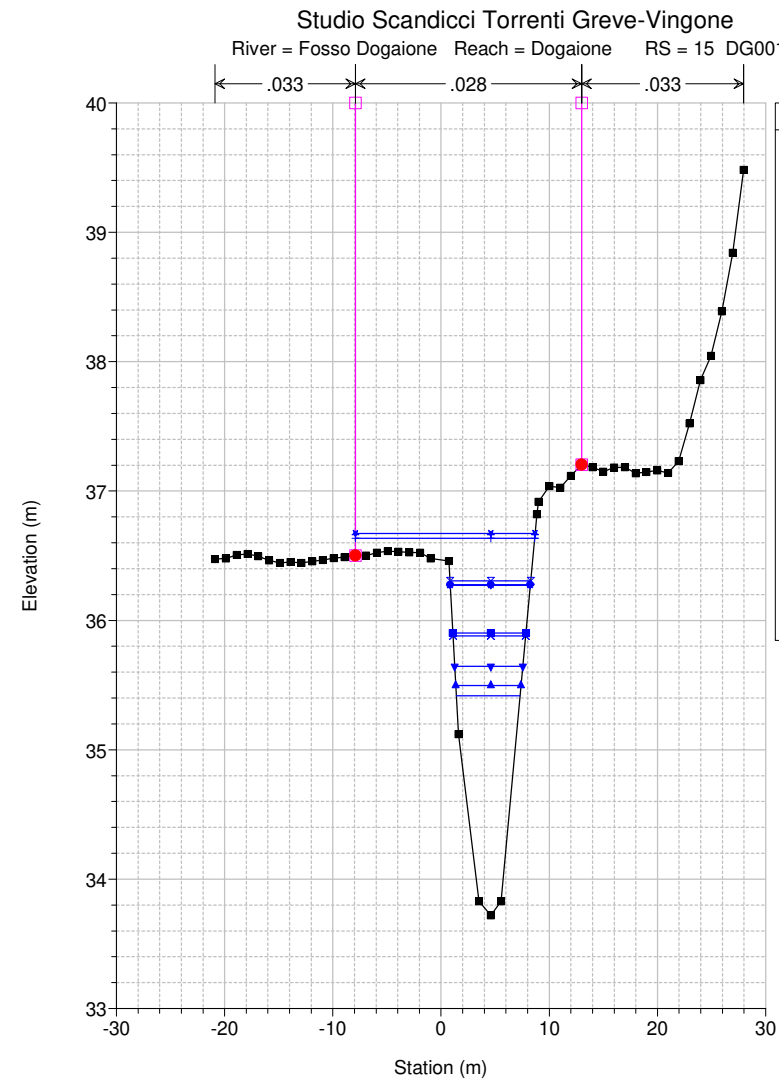
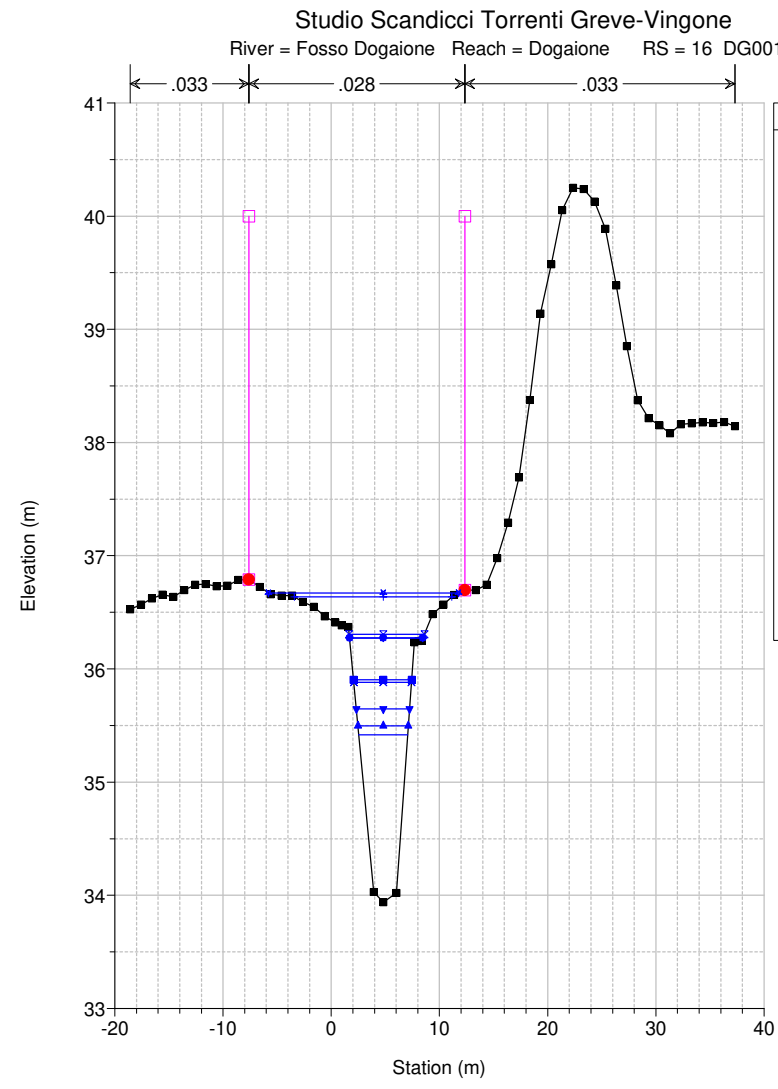
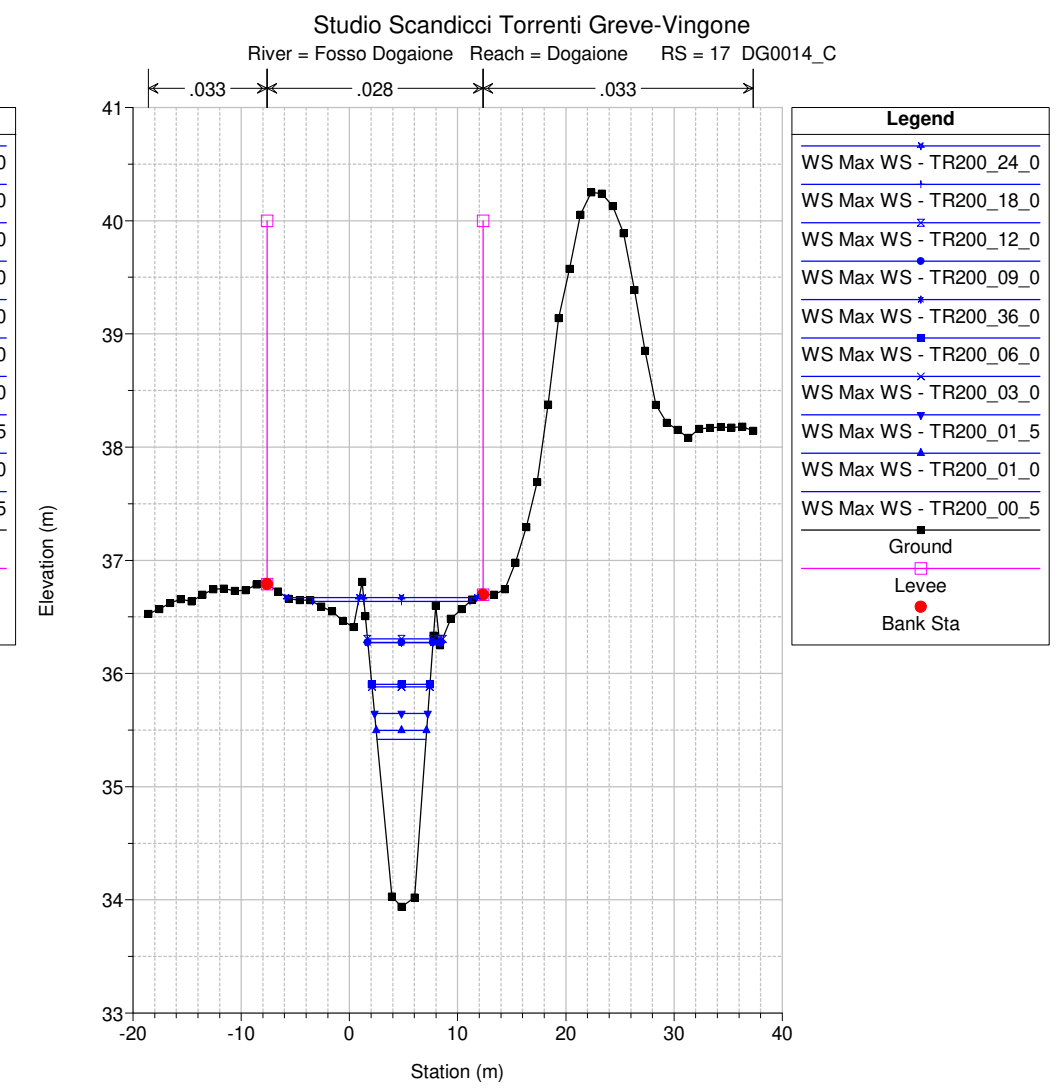
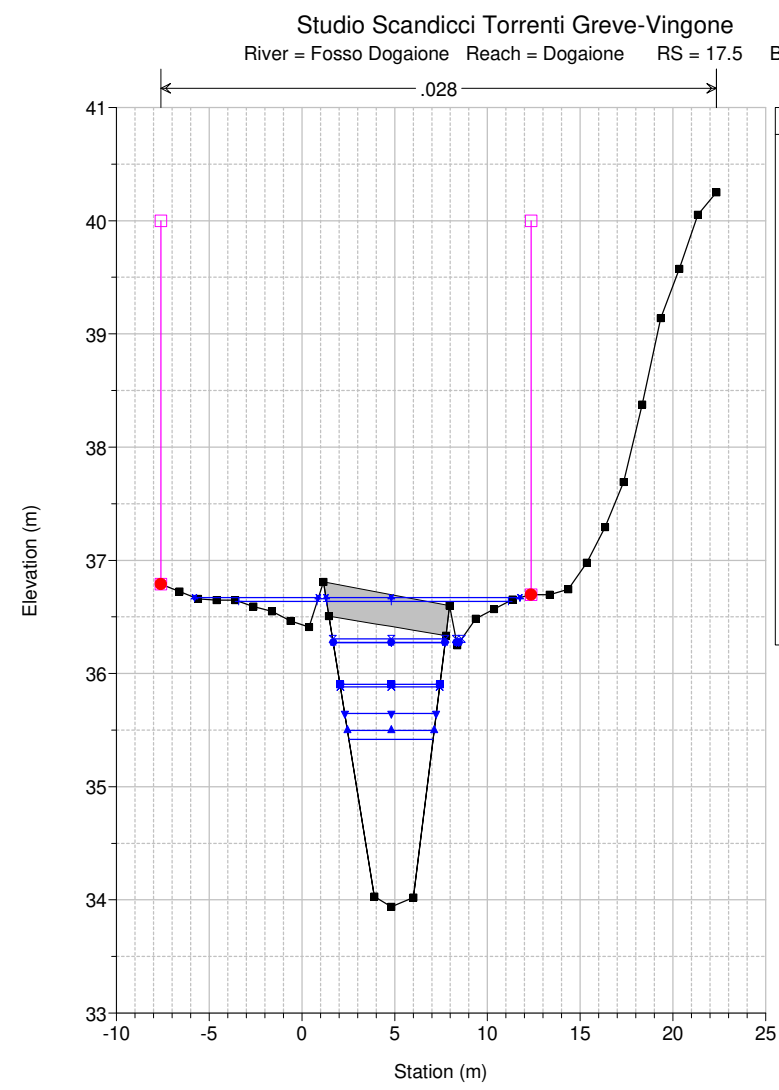
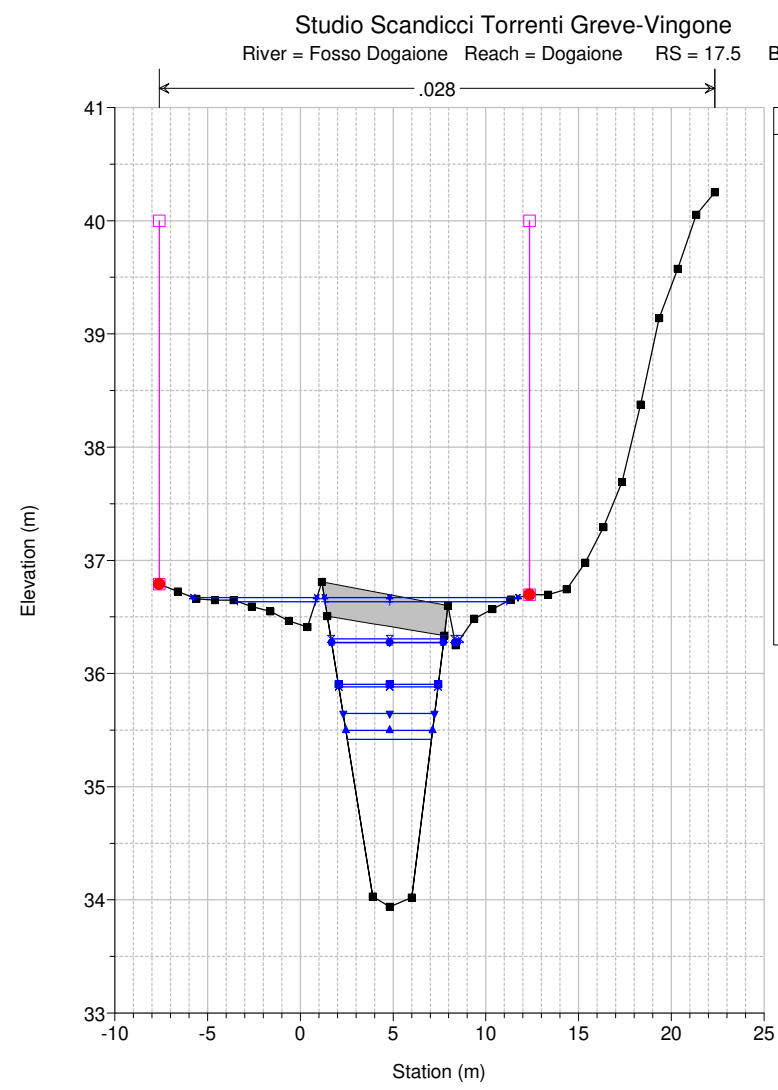

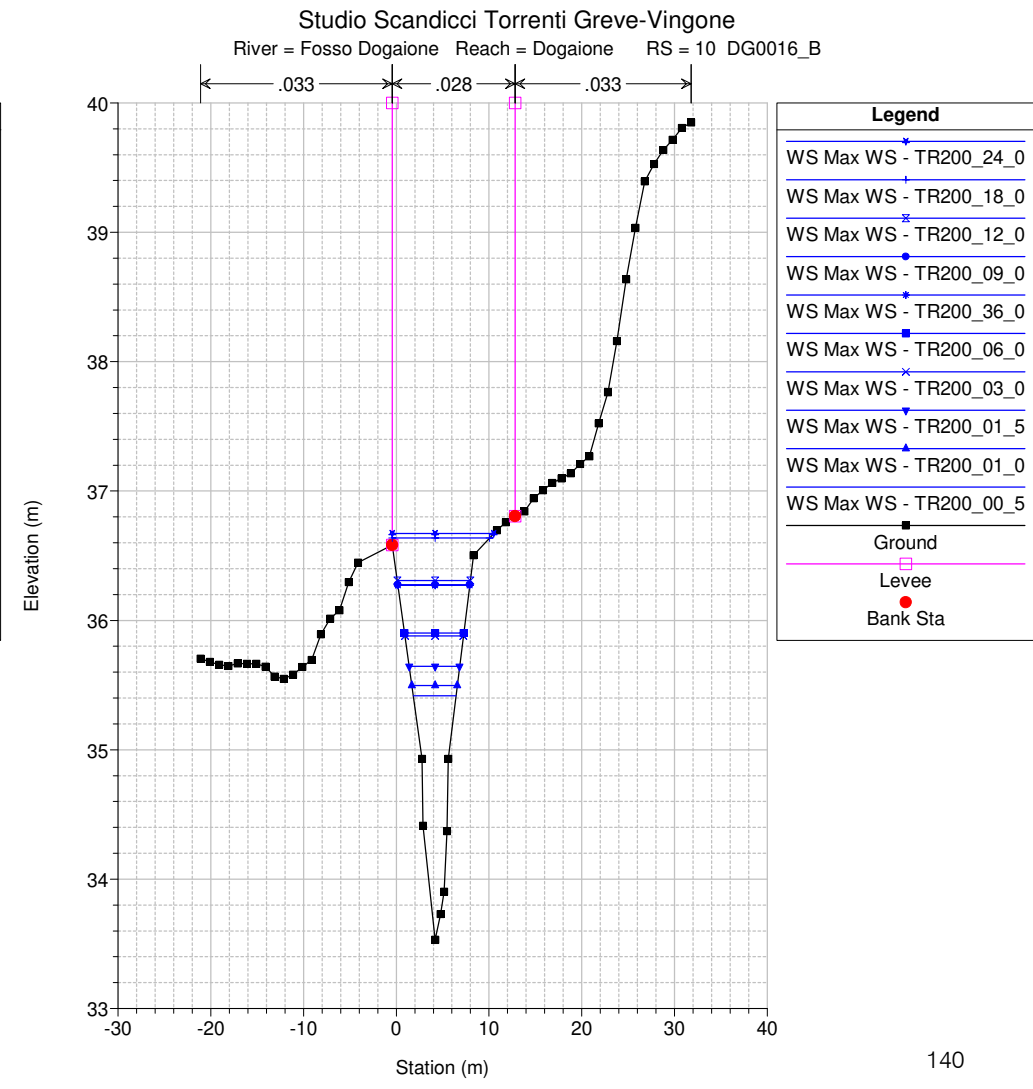
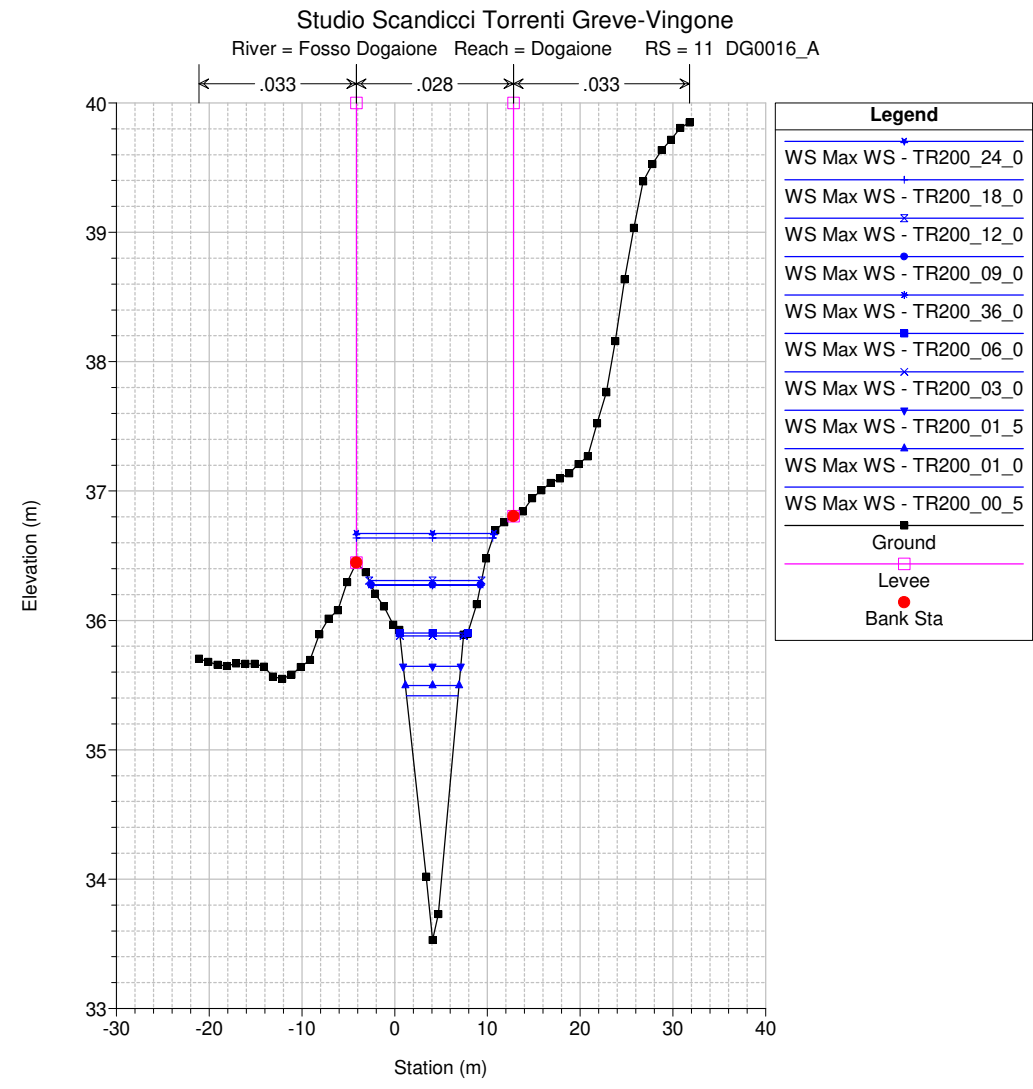
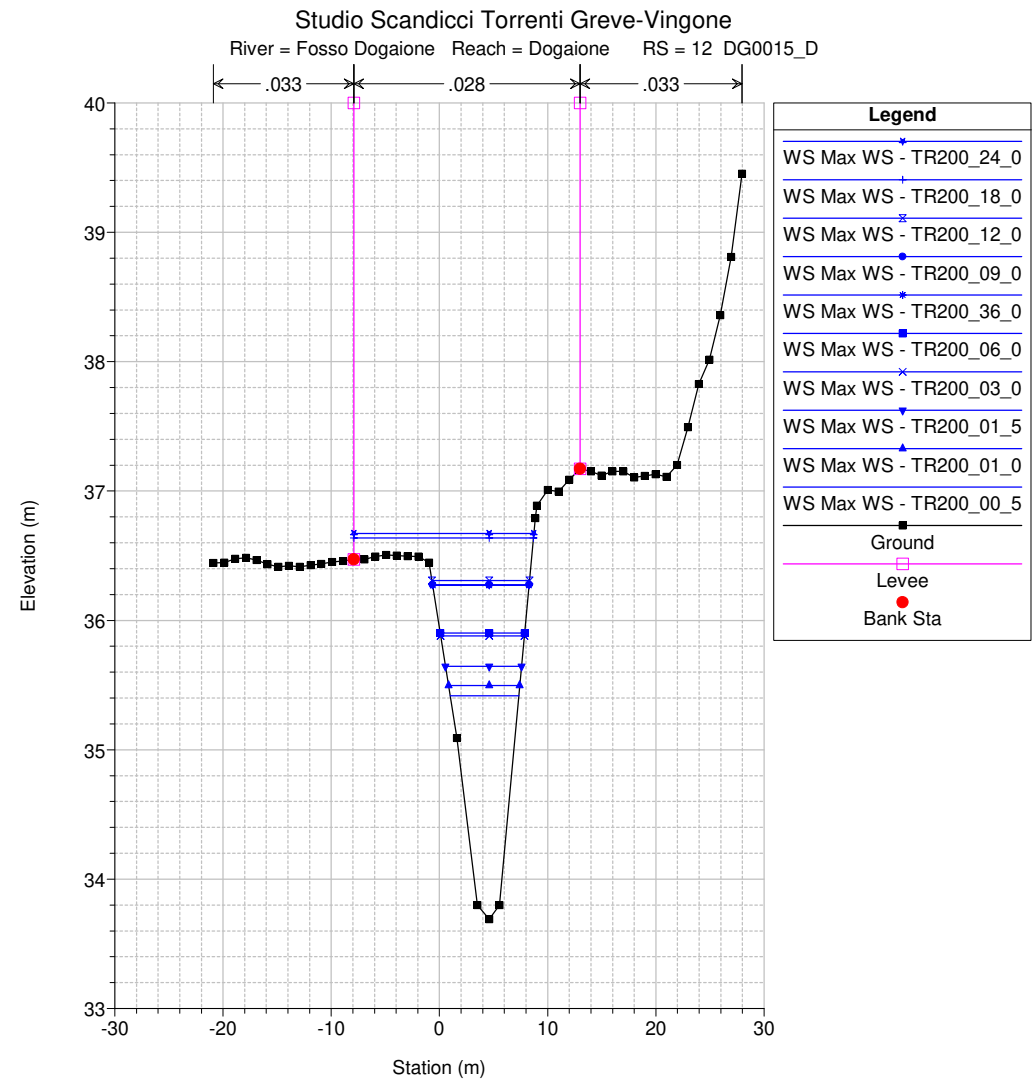
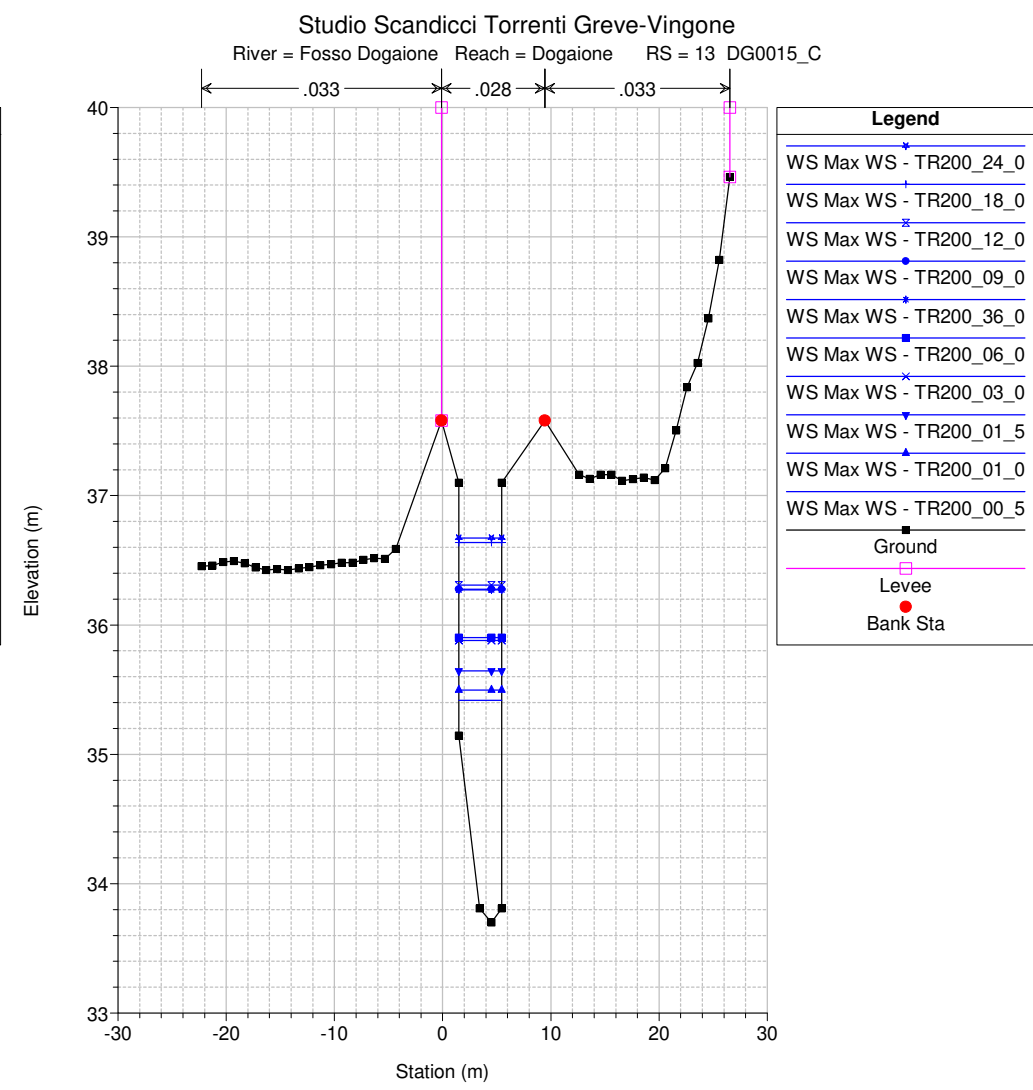
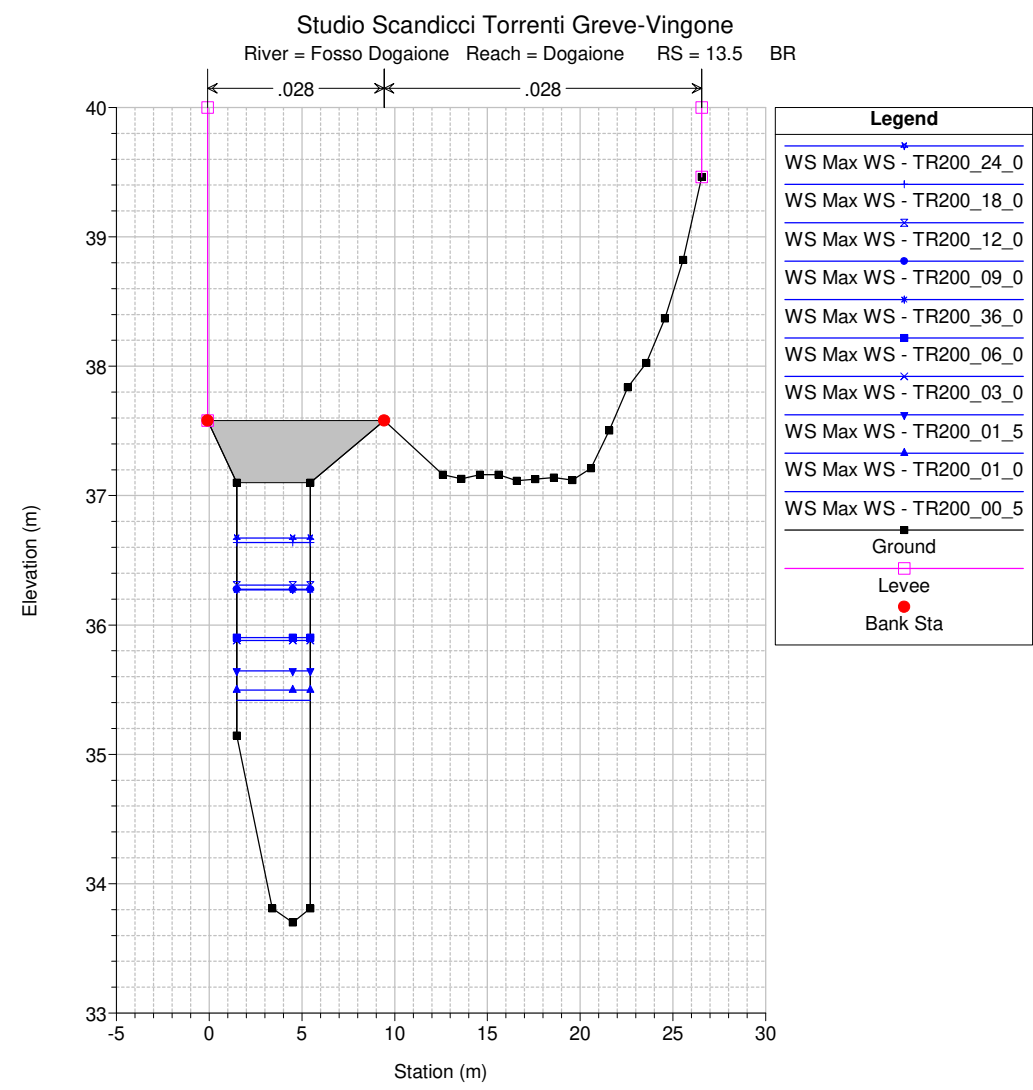
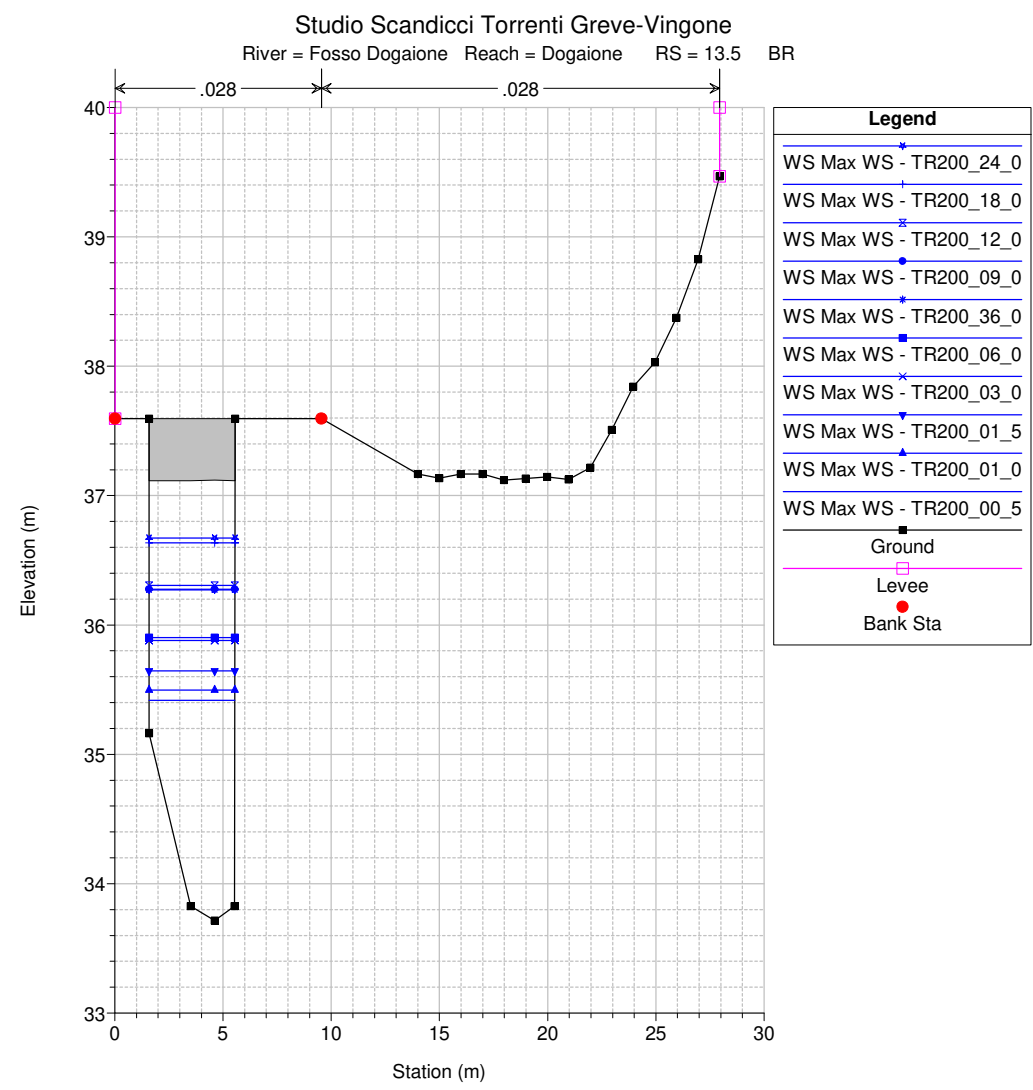

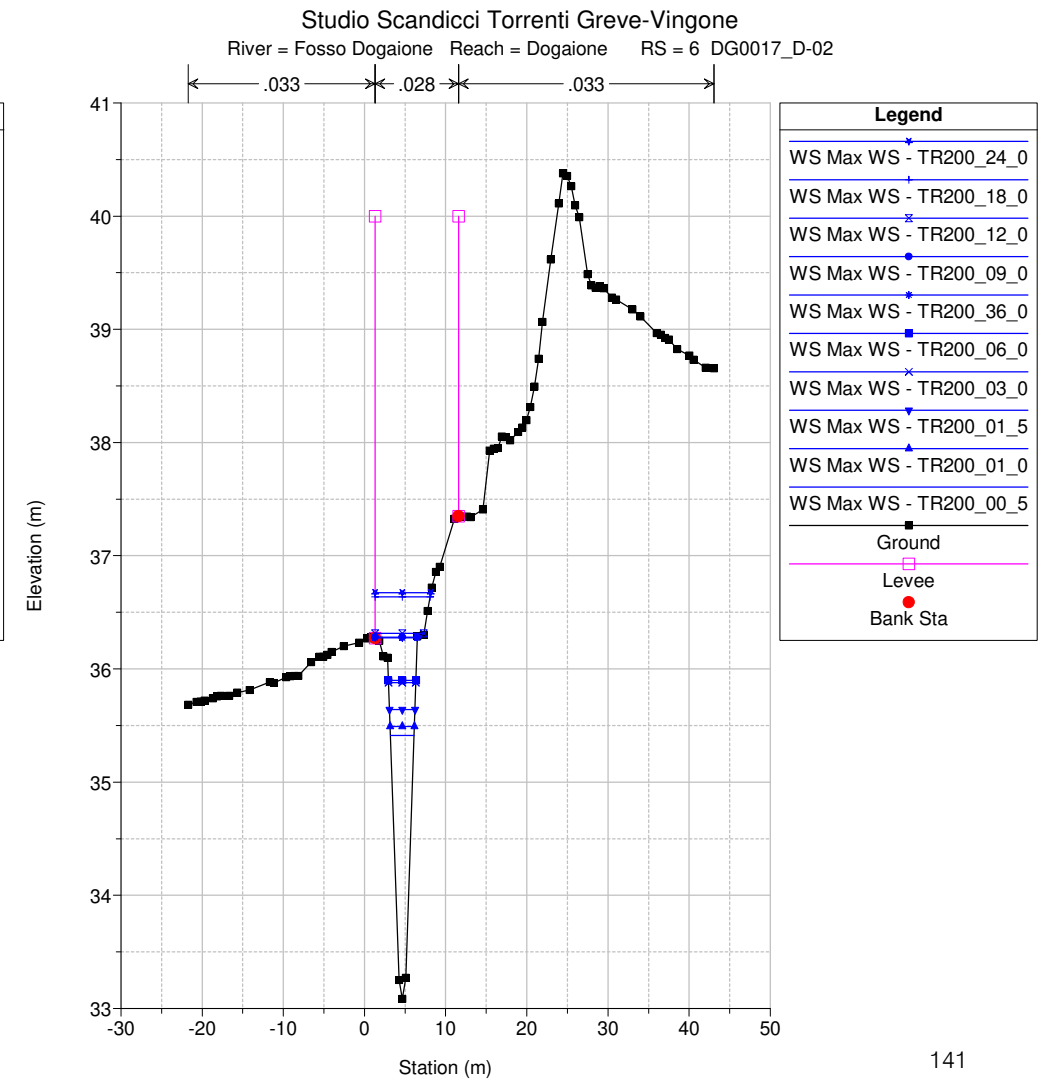
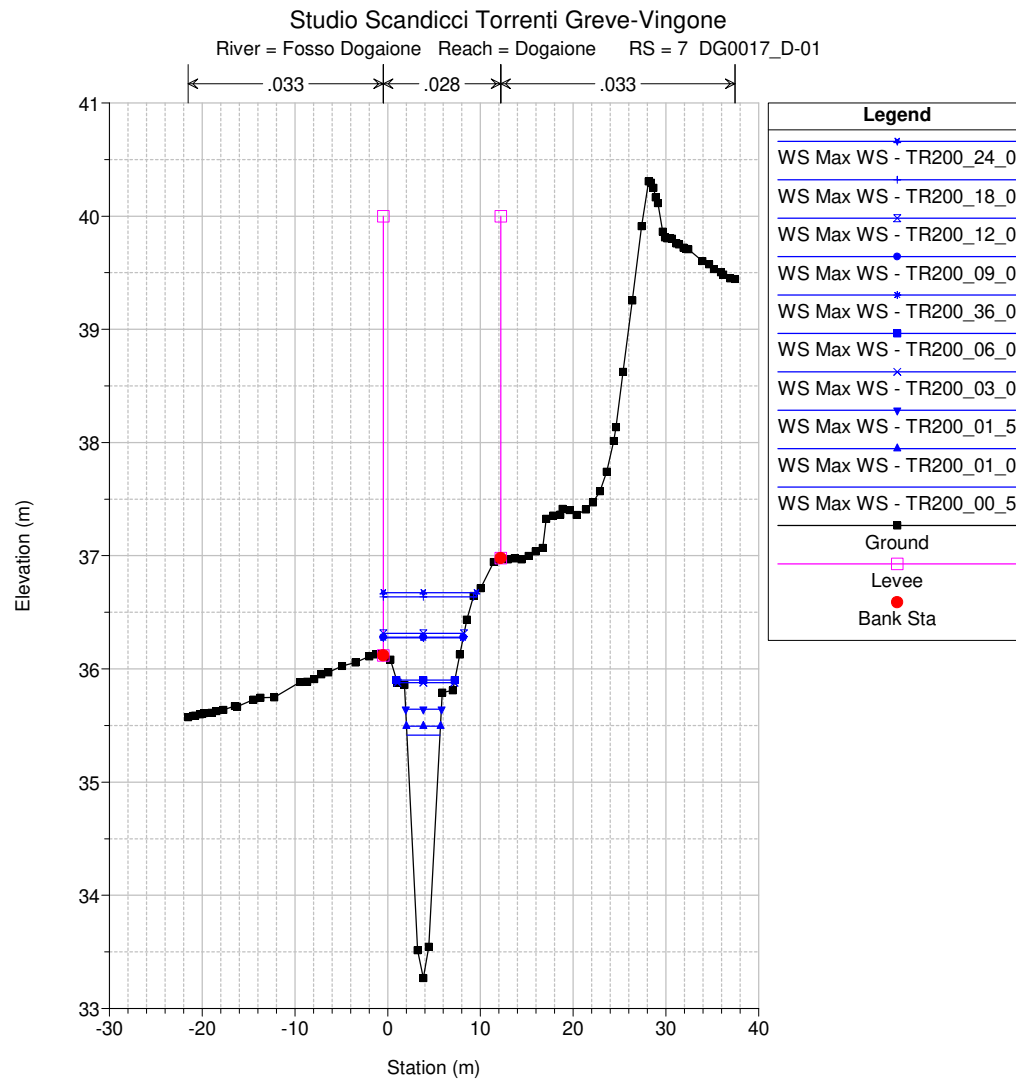
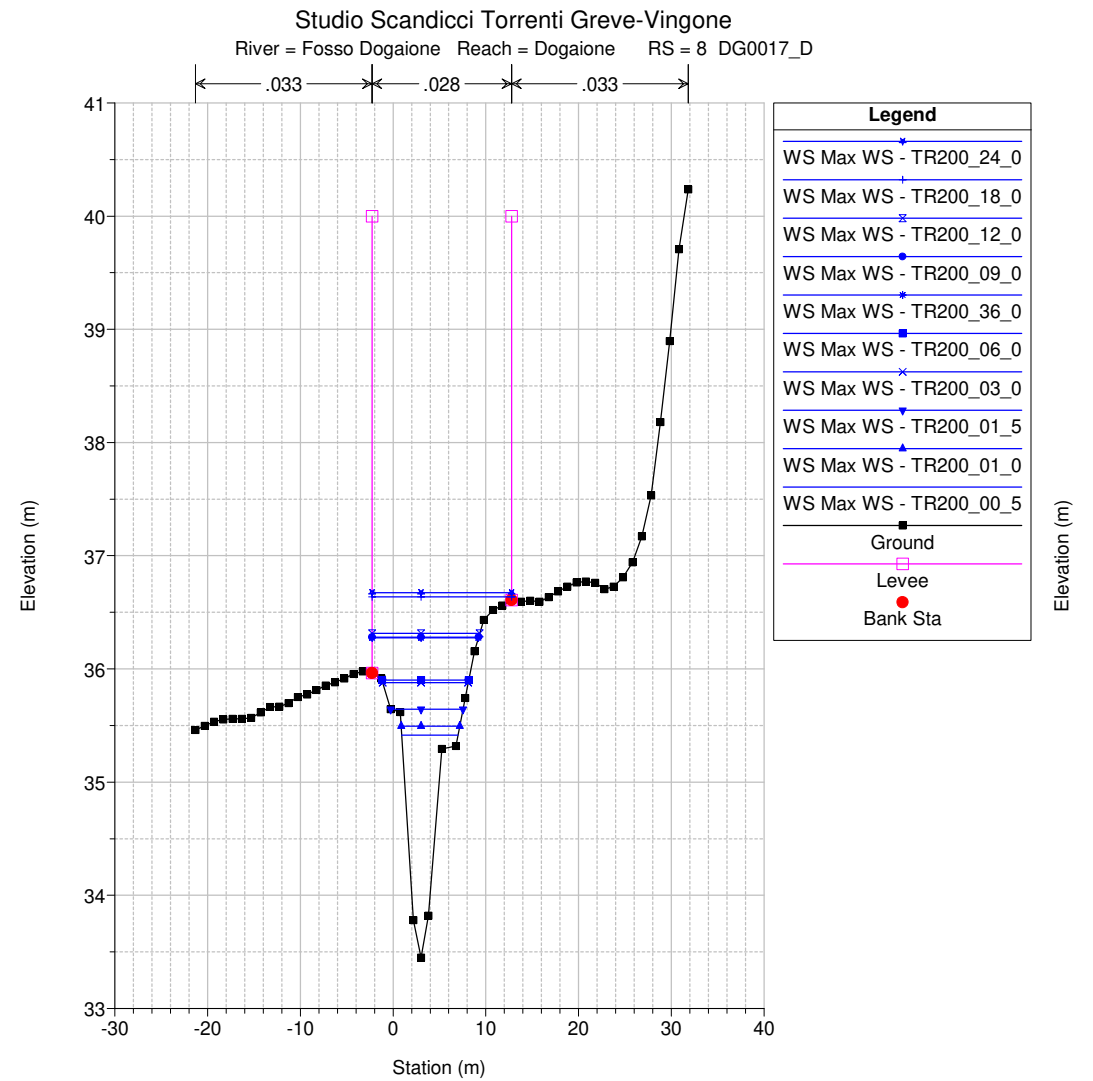
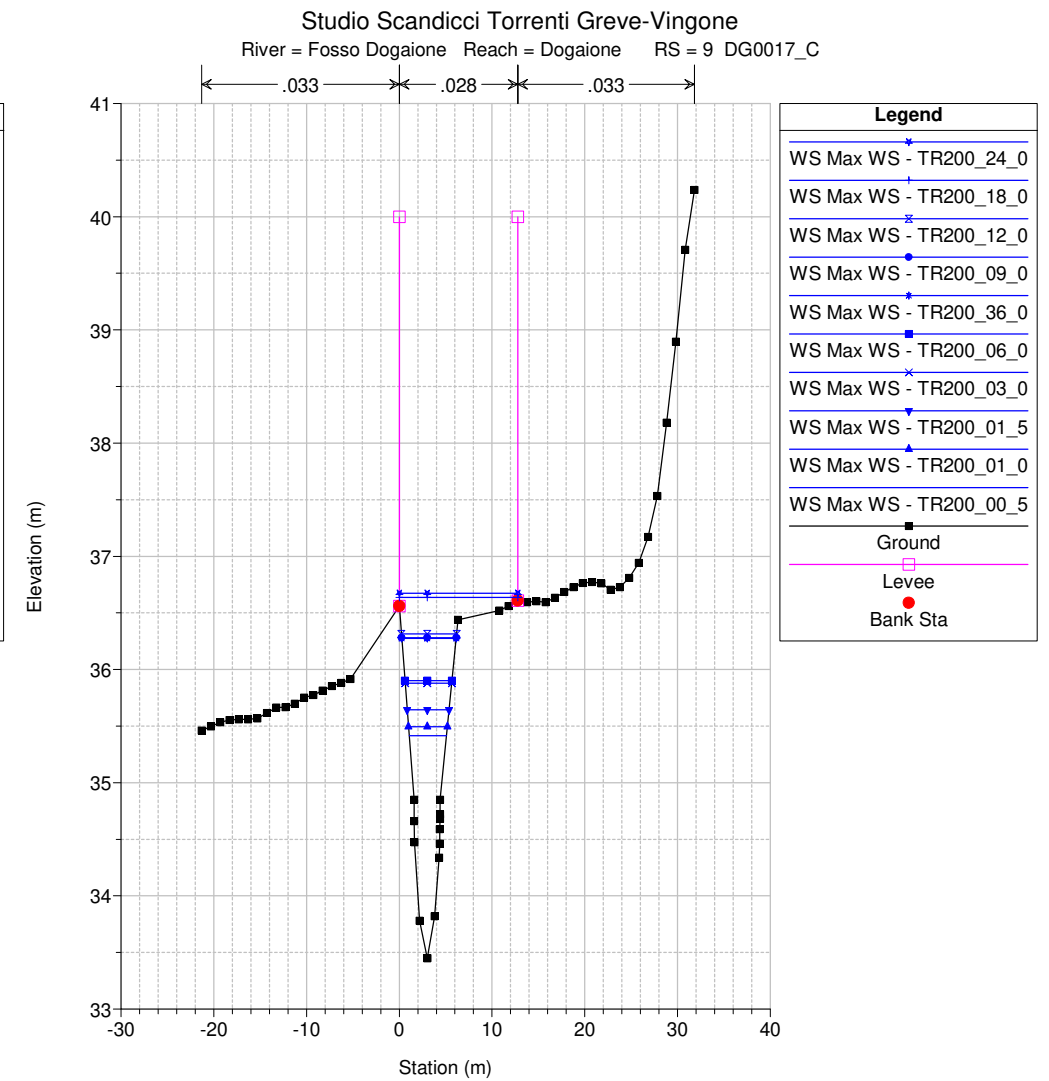
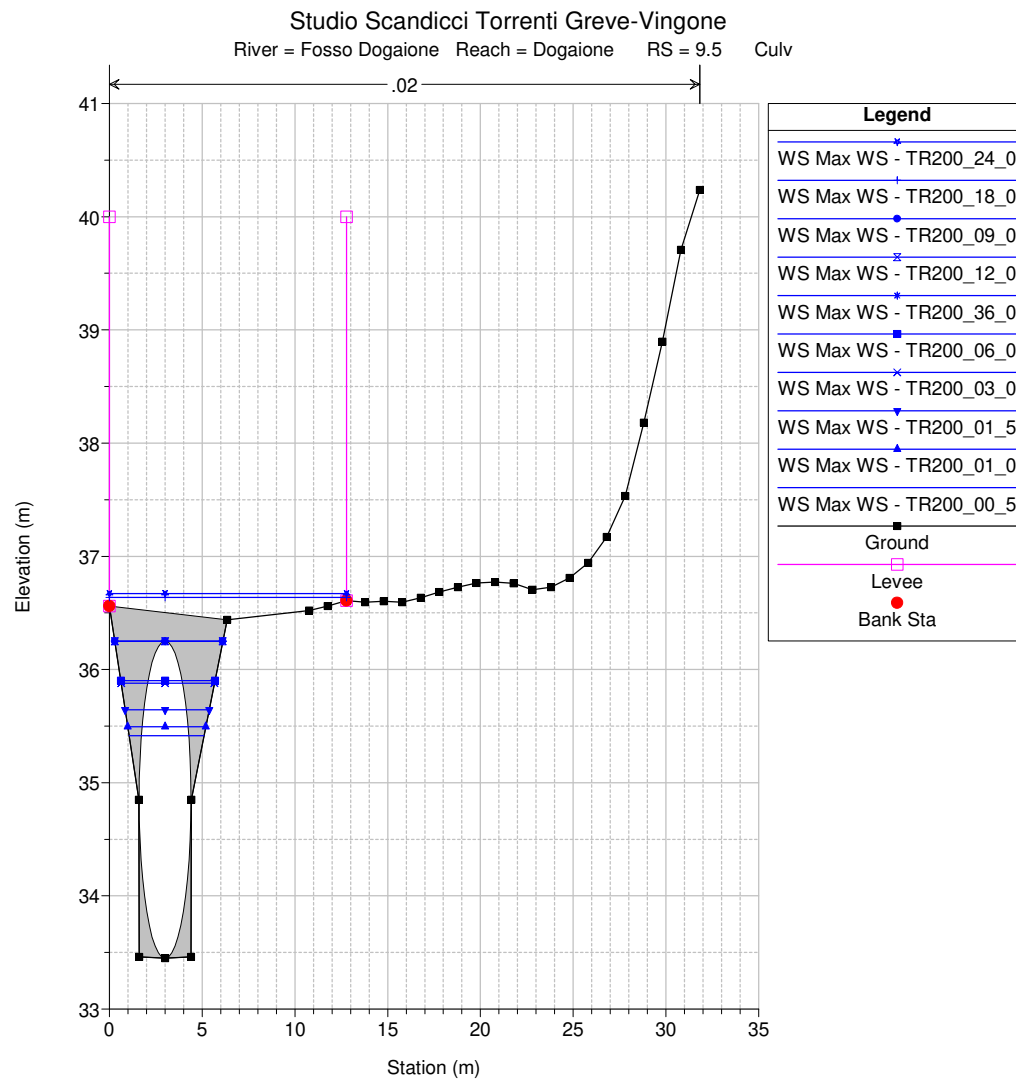
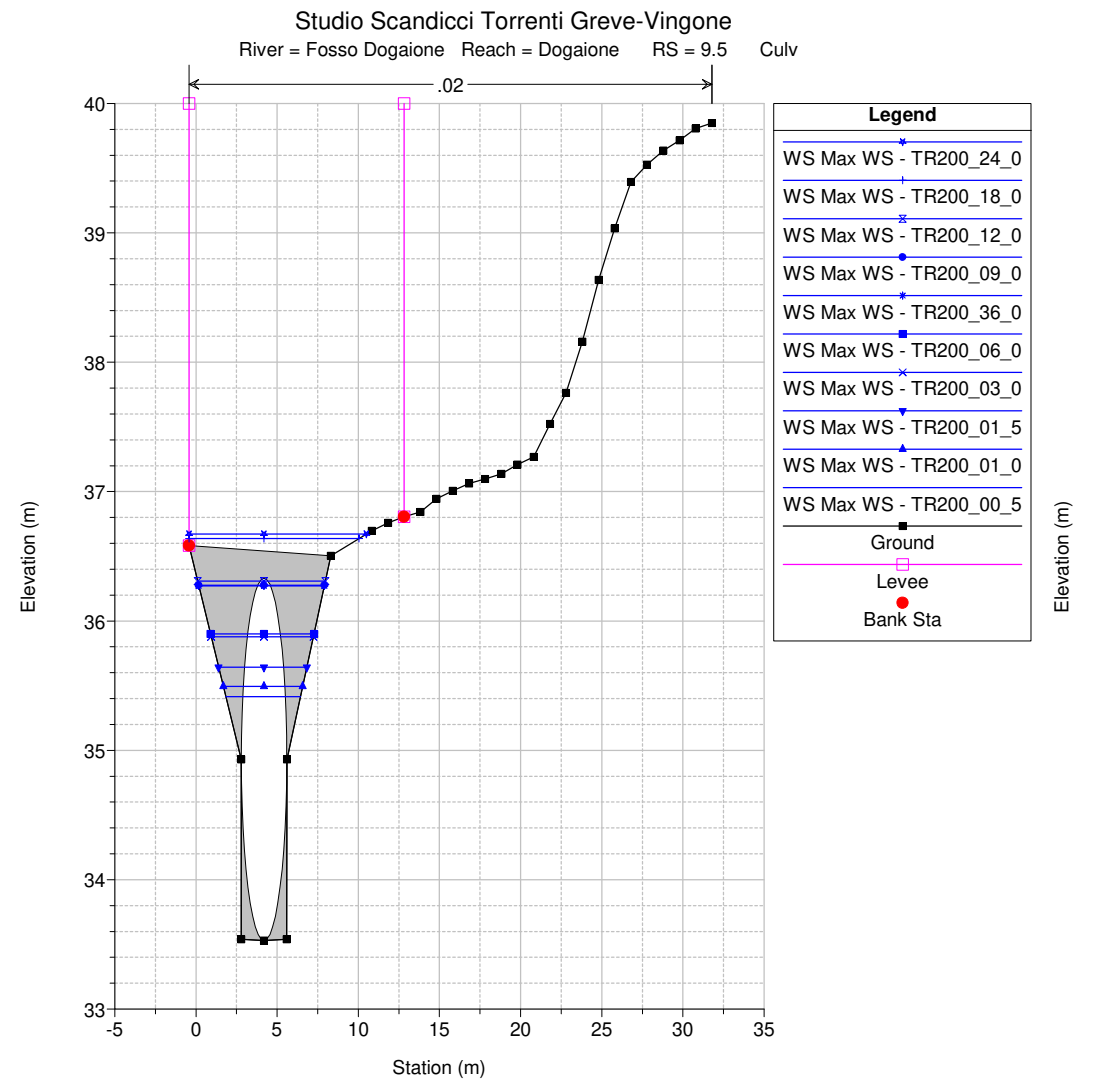

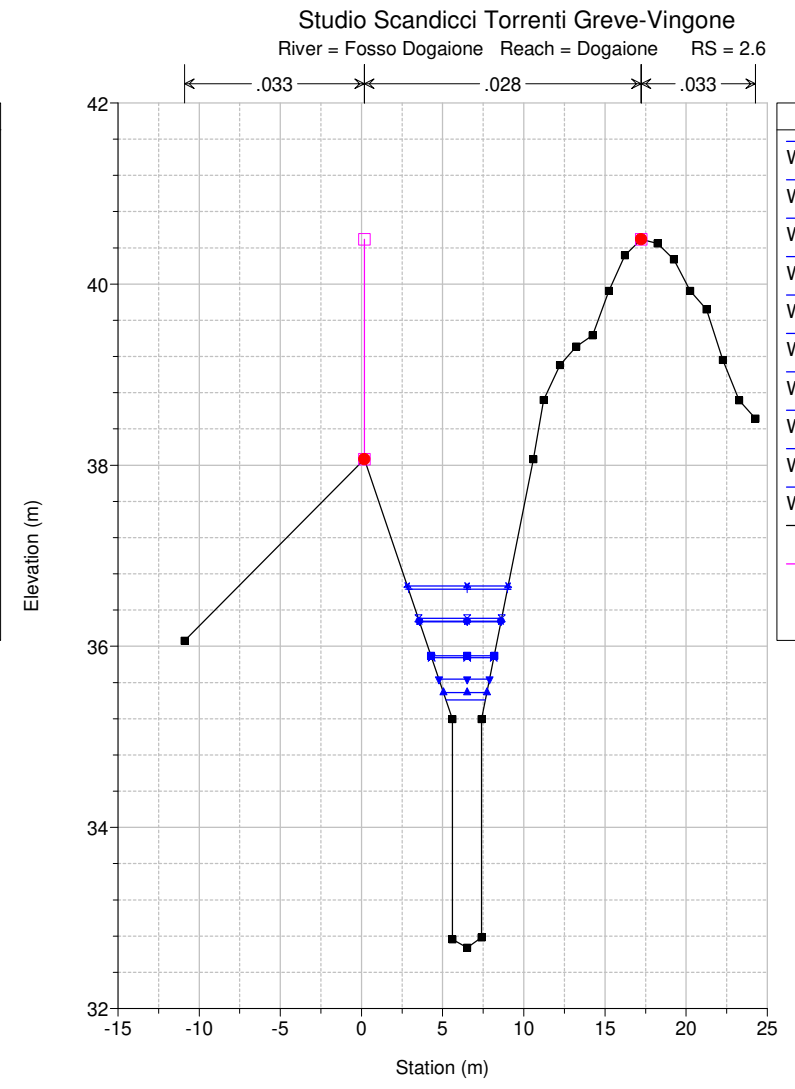
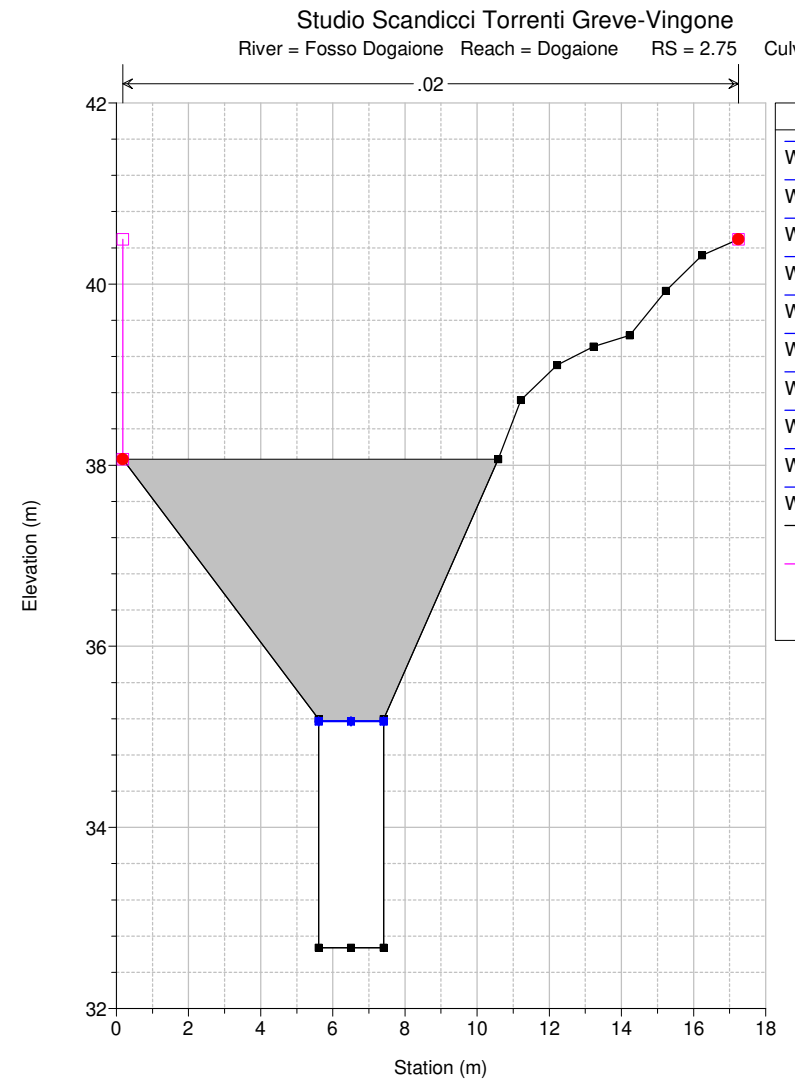
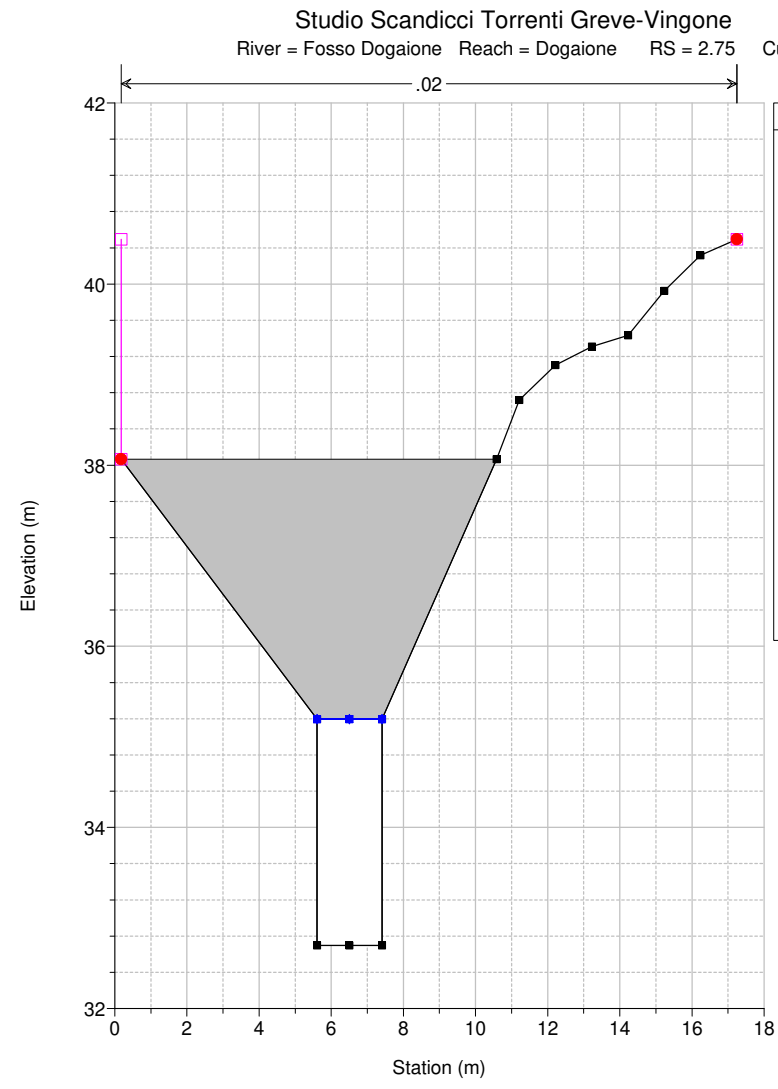
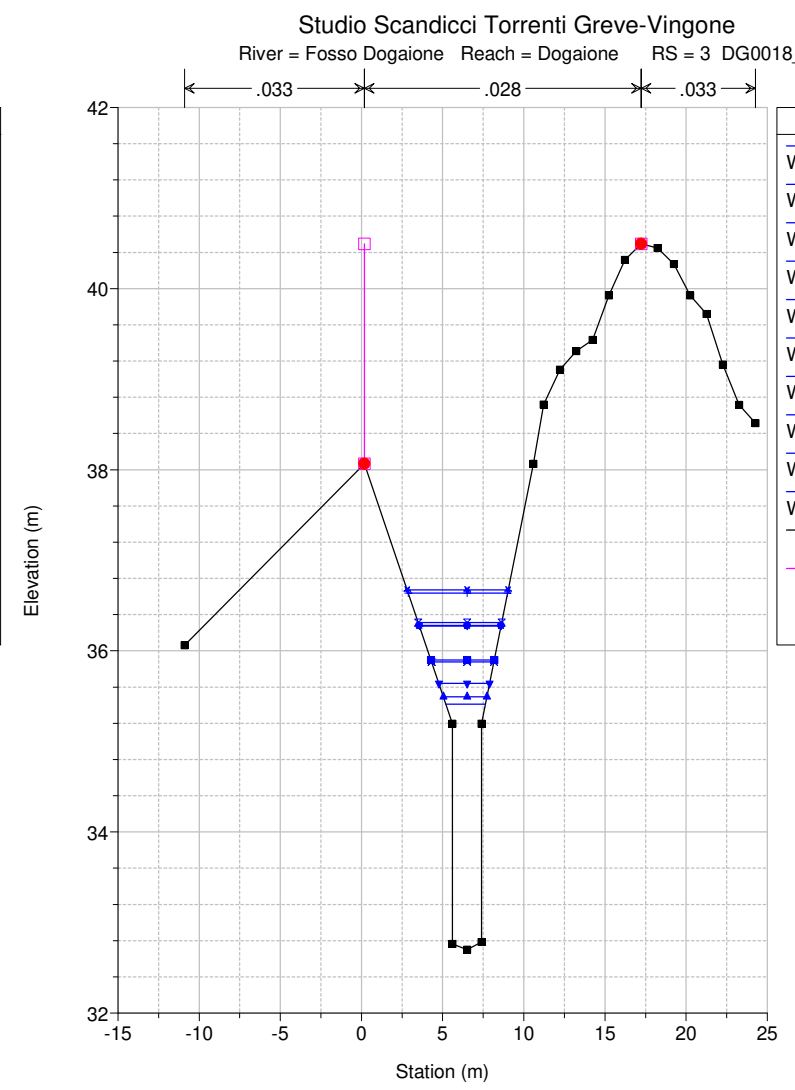
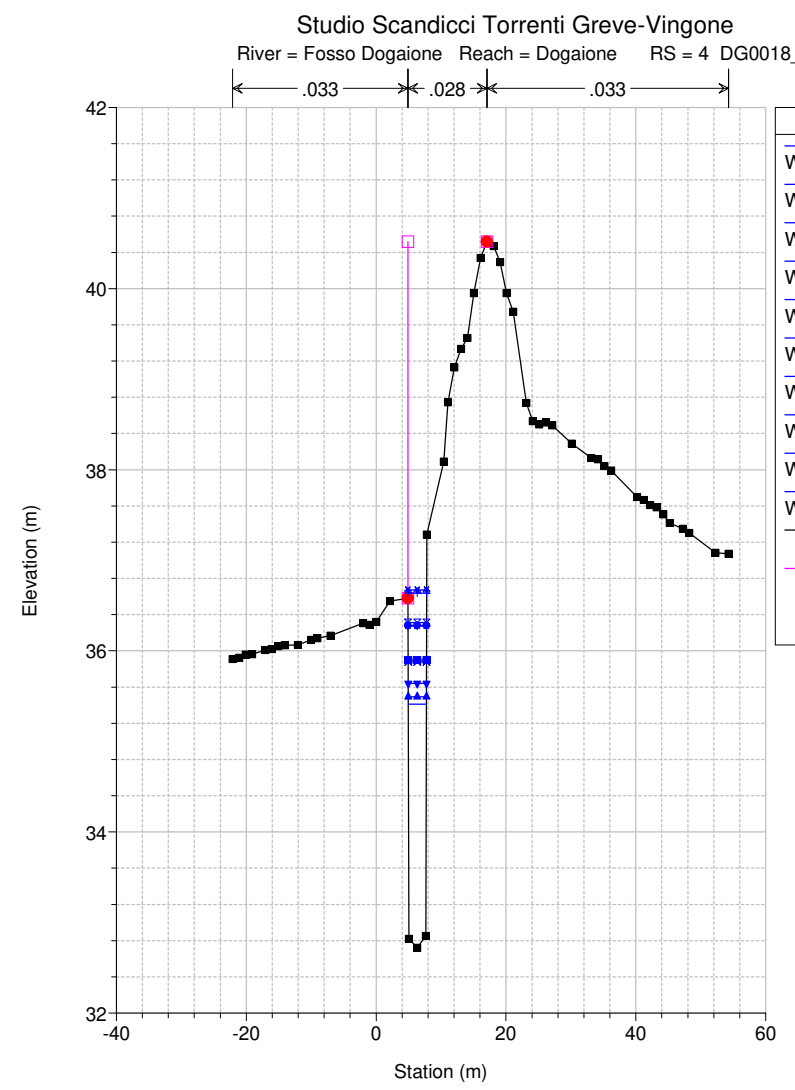
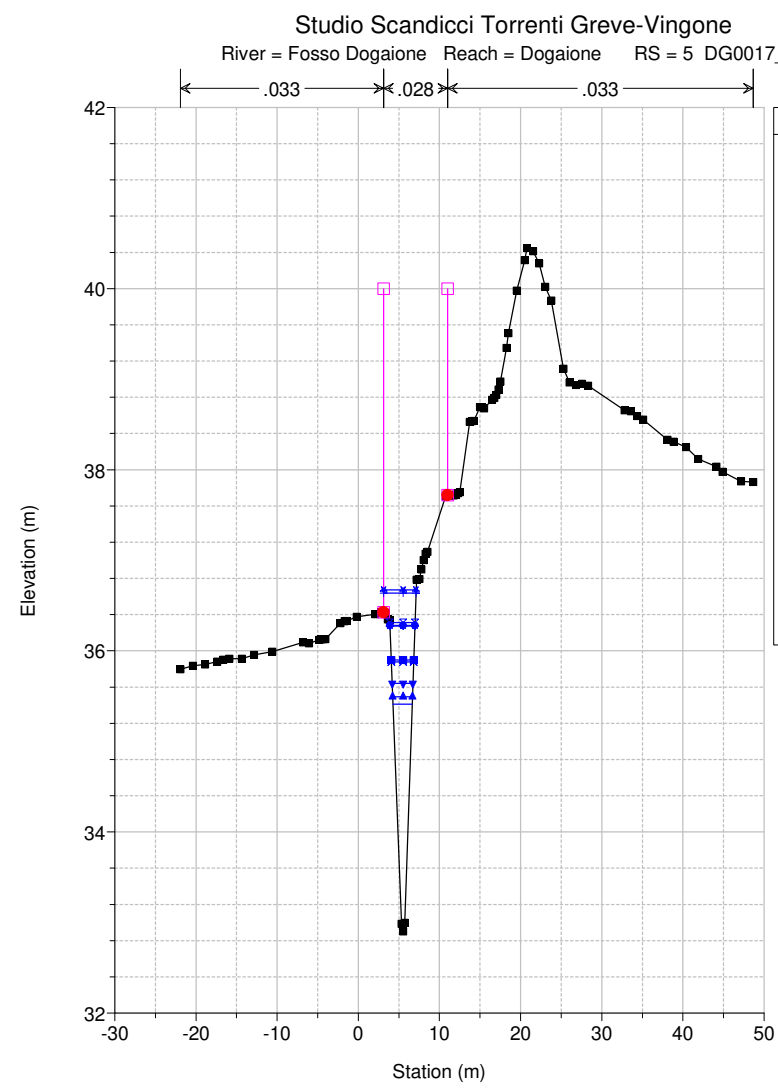

Studio Scandicci Torrenti Greve-Vingone
River = Fosso Dogaione Reach = Dogaione RS = 2.4

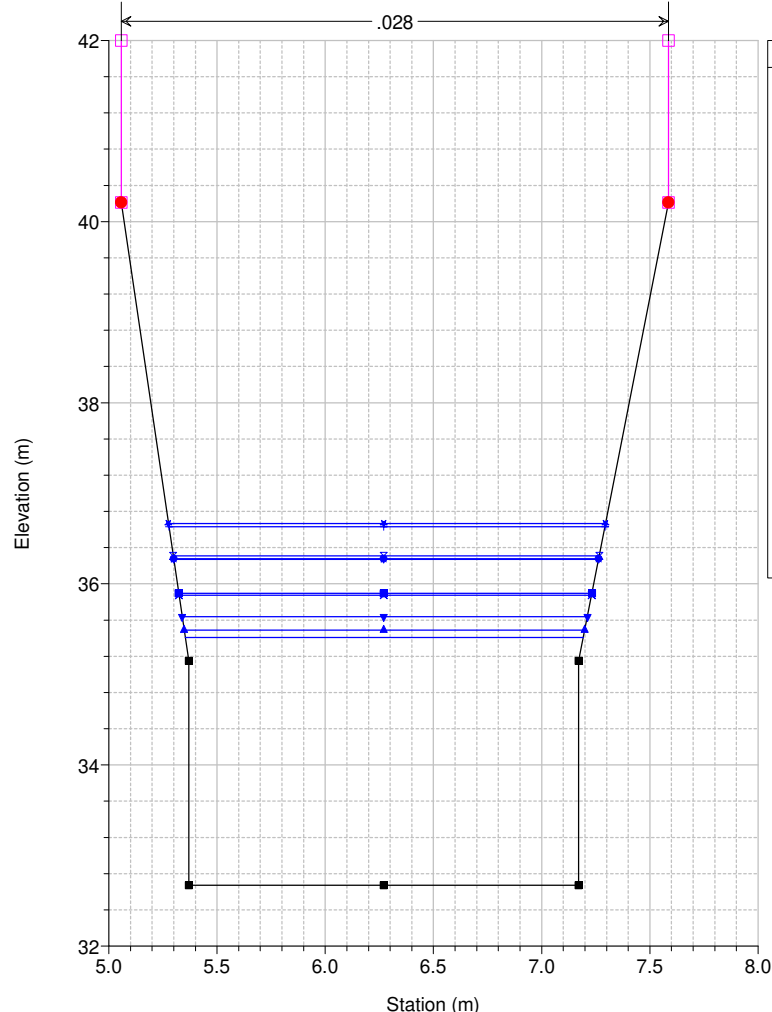

Legend	
WS Max WS - TR200_24_0	+
WS Max WS - TR200_18_0	*
WS Max WS - TR200_12_0	x
WS Max WS - TR200_09_0	o
WS Max WS - TR200_36_0	■
WS Max WS - TR200_06_0	■
WS Max WS - TR200_03_0	x
WS Max WS - TR200_01_5	▼
WS Max WS - TR200_01_0	▲
WS Max WS - TR200_00_5	▲
Ground	■
Levee	□
Bank Sta	●

Studio Scandicci Torrenti Greve-Vingone
River = Fosso Dogaione Reach = Dogaione RS = 2.25 IS

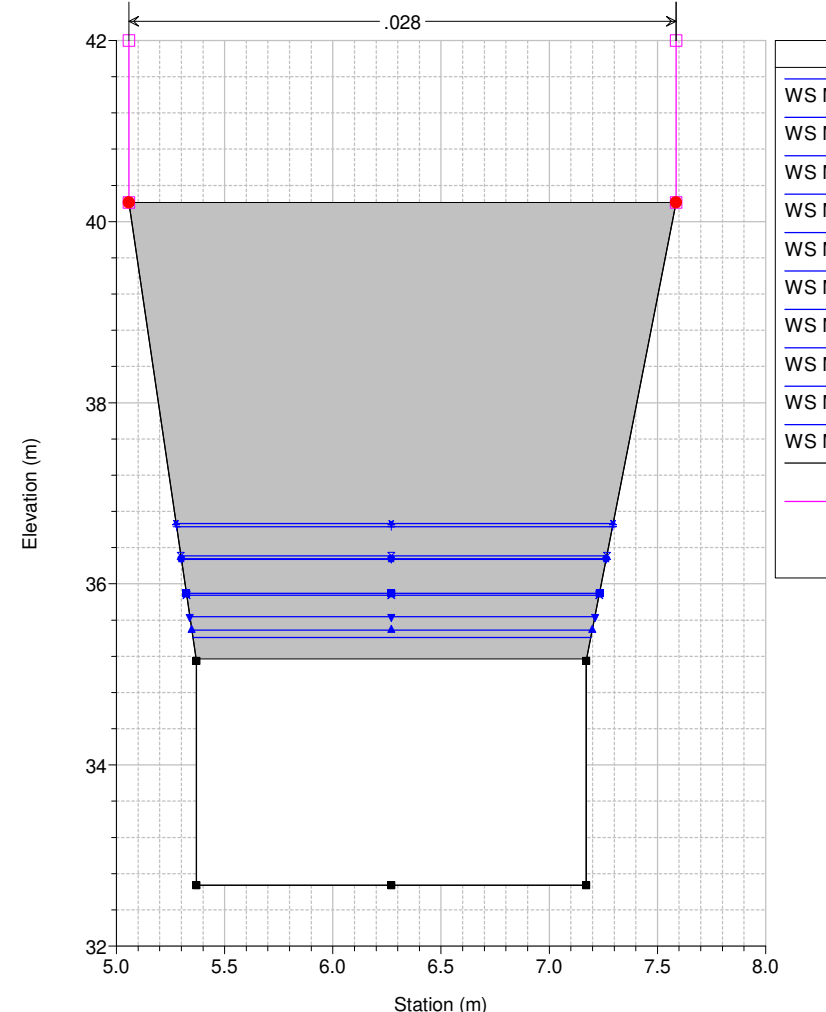

Legend	
WS Max WS - TR200_24_0	+
WS Max WS - TR200_18_0	*
WS Max WS - TR200_12_0	x
WS Max WS - TR200_09_0	o
WS Max WS - TR200_36_0	■
WS Max WS - TR200_06_0	■
WS Max WS - TR200_03_0	x
WS Max WS - TR200_01_5	▼
WS Max WS - TR200_01_0	▲
WS Max WS - TR200_00_5	▲
Ground	■
Levee	□
Bank Sta	●

Studio Scandicci Torrenti Greve-Vingone
River = Fosso Dogaione Reach = Dogaione RS = 2 DG0018_C

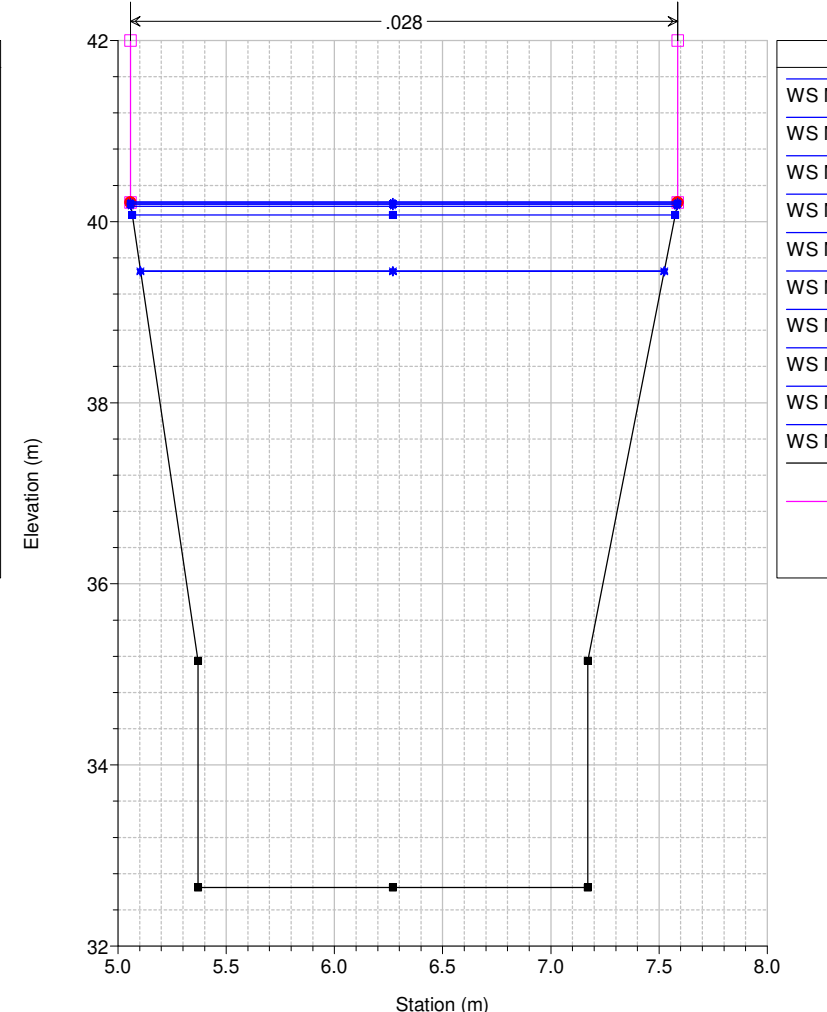

Legend	
WS Max WS - TR200_18_0	+
WS Max WS - TR200_24_0	*
WS Max WS - TR200_09_0	o
WS Max WS - TR200_12_0	x
WS Max WS - TR200_36_0	■
WS Max WS - TR200_06_0	■
WS Max WS - TR200_03_0	x
WS Max WS - TR200_03_0	x
WS Max WS - TR200_00_5	▲
WS Max WS - TR200_01_0	▲
WS Max WS - TR200_01_5	▼
Ground	■
Levee	□
Bank Sta	●

Studio Scandicci Torrenti Greve-Vingone
River = Fosso Dogaione Reach = Dogaione RS = 1 DG0018_D

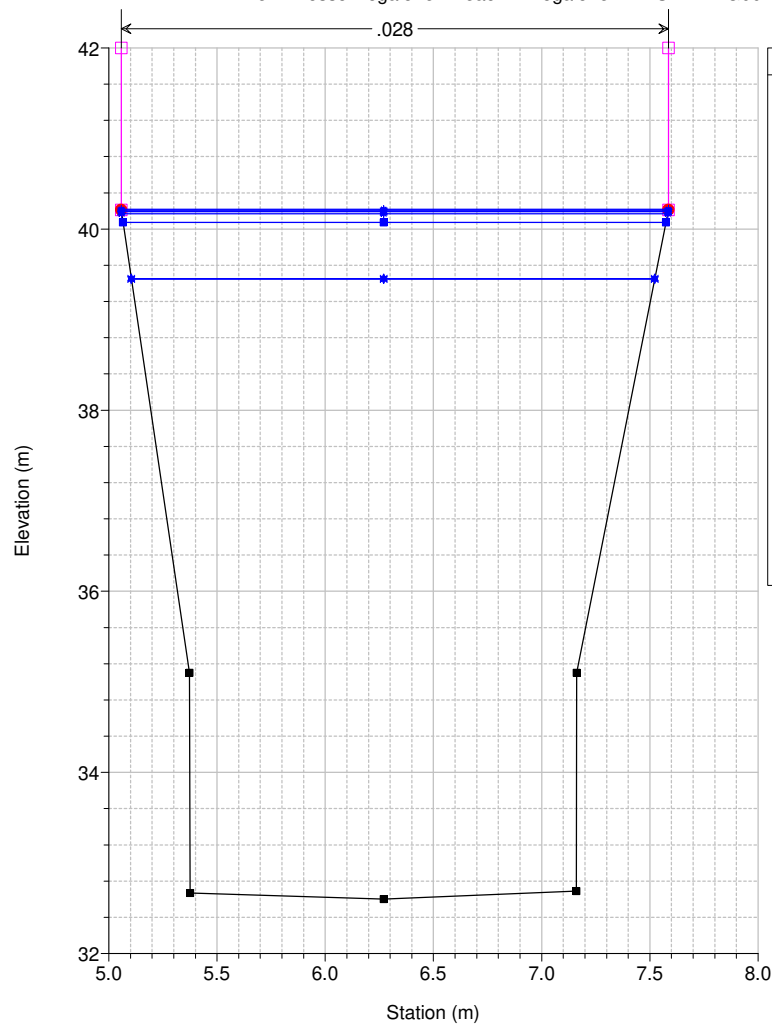

Legend	
WS Max WS - TR200_18_0	+
WS Max WS - TR200_24_0	*
WS Max WS - TR200_09_0	o
WS Max WS - TR200_12_0	x
WS Max WS - TR200_36_0	■
WS Max WS - TR200_06_0	■
WS Max WS - TR200_03_0	x
WS Max WS - TR200_00_5	▲
WS Max WS - TR200_01_0	▲
WS Max WS - TR200_01_5	▼
Ground	■
Levee	□
Bank Sta	●

Studio Scandicci Torrenti Greve-Vingone
River = Fosso Dogaione Reach = Dogaione RS = 0.5 AR0521

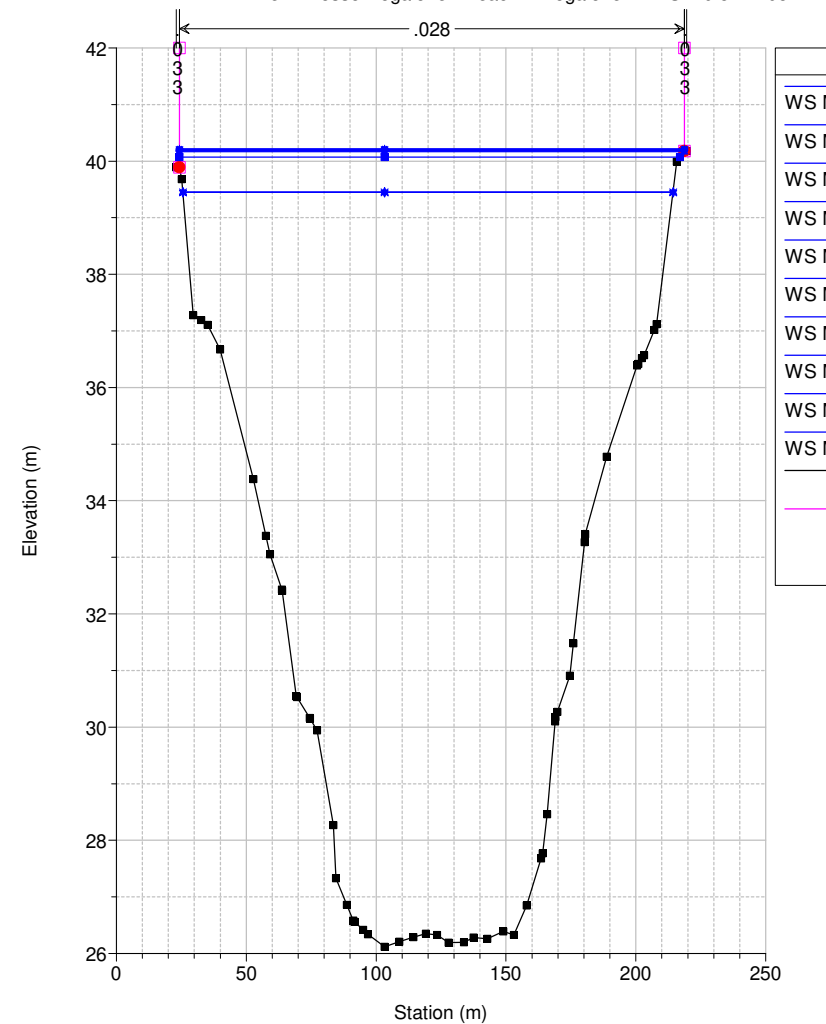

Legend	
WS Max WS - TR200_18_0	+
WS Max WS - TR200_24_0	*
WS Max WS - TR200_09_0	o
WS Max WS - TR200_12_0	x
WS Max WS - TR200_36_0	■
WS Max WS - TR200_06_0	■
WS Max WS - TR200_03_0	x
WS Max WS - TR200_00_5	▲
WS Max WS - TR200_01_0	▲
WS Max WS - TR200_01_5	▼
Ground	■
Levee	□
Bank Sta	●

Studio Scandicci Torrenti Greve-Vingone
River = Fosso Rigone Reach = Rigone 03 RS = 63 RI0001_D

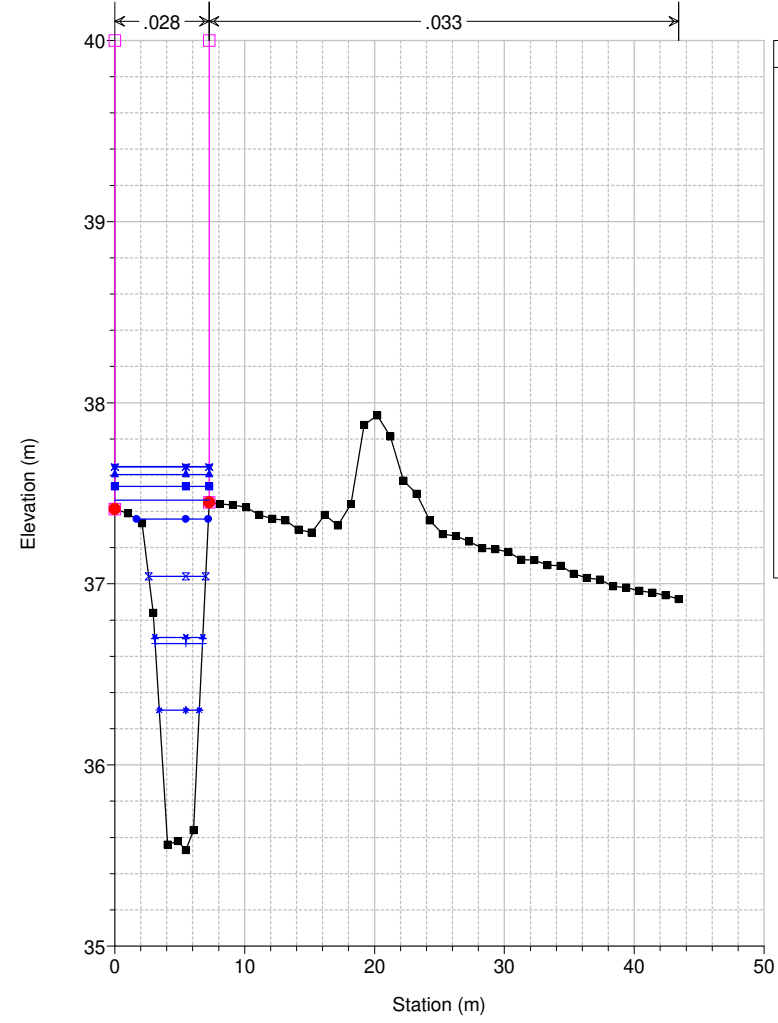

Legend	
WS Max WS - TR200_01_5	▲
WS Max WS - TR200_03_0	×
WS Max WS - TR200_01_0	▲
WS Max WS - TR200_06_0	■
WS Max WS - TR200_00_5	●
WS Max WS - TR200_09_0	●
WS Max WS - TR200_12_0	×
WS Max WS - TR200_24_0	▲
WS Max WS - TR200_18_0	▲
WS Max WS - TR200_36_0	▲
Ground	■
Levee	□
Bank Sta	●

Studio Scandicci Torrenti Greve-Vingone
River = Fosso Rigone Reach = Rigone 03 RS = 62 RI0002_

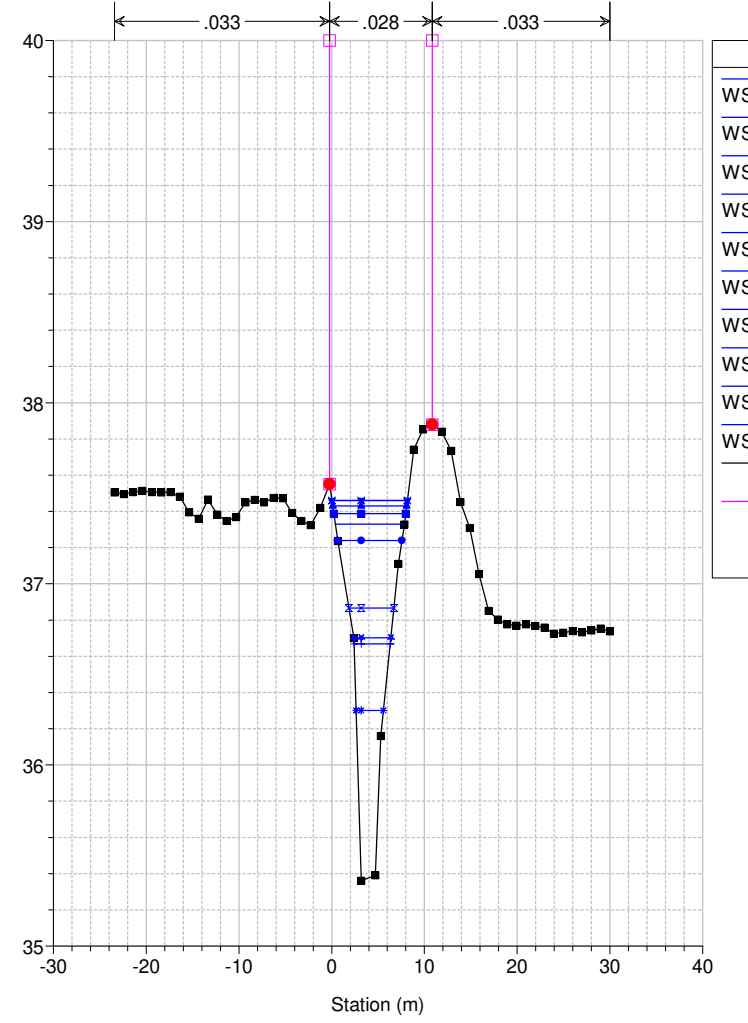

Legend	
WS Max WS - TR200_01_5	▲
WS Max WS - TR200_03_0	×
WS Max WS - TR200_01_0	▲
WS Max WS - TR200_06_0	■
WS Max WS - TR200_00_5	●
WS Max WS - TR200_09_0	●
WS Max WS - TR200_12_0	×
WS Max WS - TR200_24_0	▲
WS Max WS - TR200_18_0	▲
WS Max WS - TR200_36_0	▲
Ground	■
Levee	□
Bank Sta	●

Studio Scandicci Torrenti Greve-Vingone
River = Fosso Rigone Reach = Rigone 03 RS = 61 RI0003_

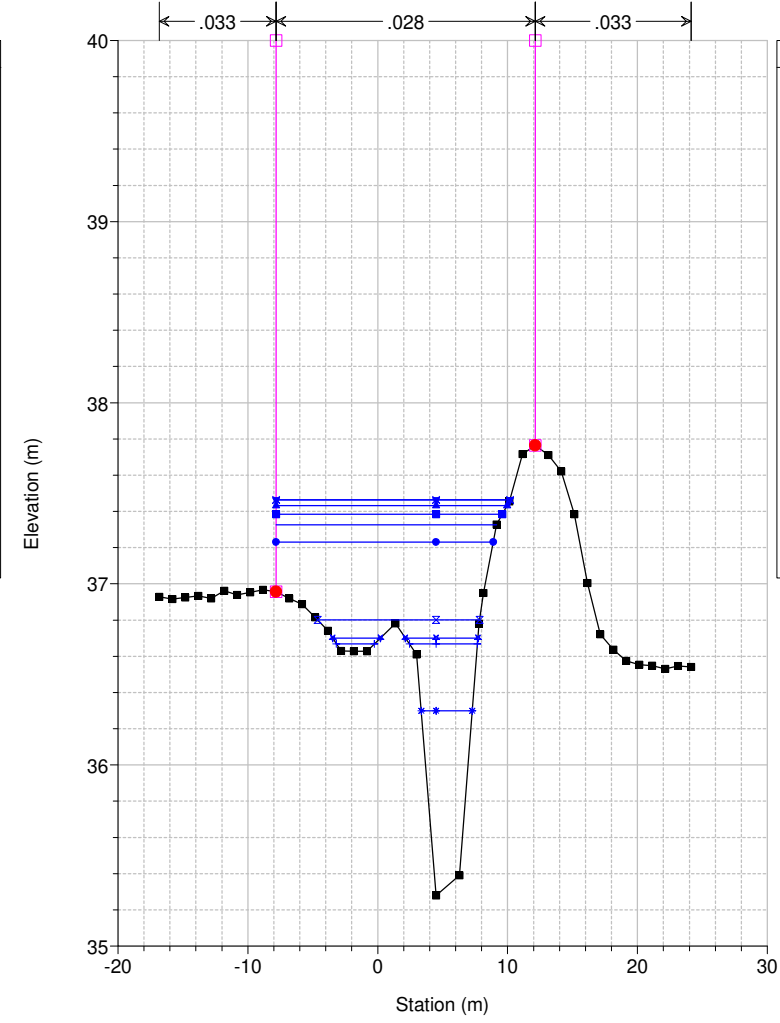

Legend	
WS Max WS - TR200_01_5	▲
WS Max WS - TR200_03_0	×
WS Max WS - TR200_01_0	▲
WS Max WS - TR200_06_0	■
WS Max WS - TR200_00_5	●
WS Max WS - TR200_09_0	●
WS Max WS - TR200_12_0	×
WS Max WS - TR200_24_0	▲
WS Max WS - TR200_18_0	▲
WS Max WS - TR200_36_0	▲
Ground	■
Levee	□
Bank Sta	●

Studio Scandicci Torrenti Greve-Vingone
River = Fosso Rigone Reach = Rigone 03 RS = 60 RI0004_

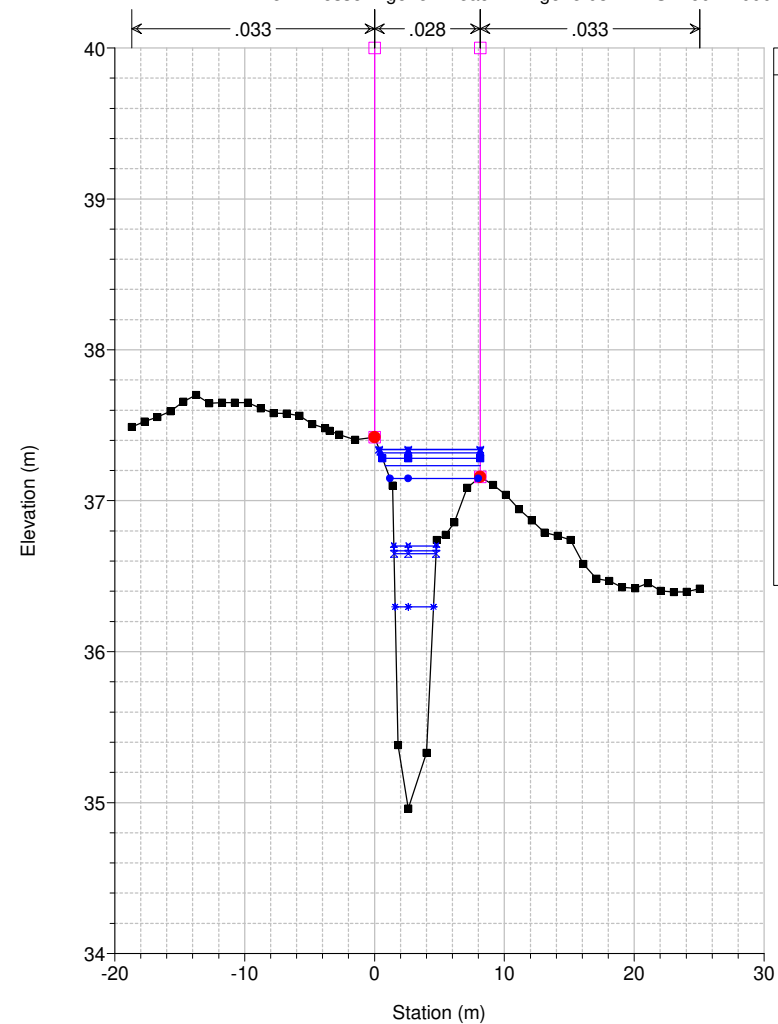

Legend	
WS Max WS - TR200_01_5	▲
WS Max WS - TR200_03_0	×
WS Max WS - TR200_01_0	▲
WS Max WS - TR200_06_0	■
WS Max WS - TR200_00_5	●
WS Max WS - TR200_09_0	●
WS Max WS - TR200_24_0	▲
WS Max WS - TR200_18_0	▲
WS Max WS - TR200_12_0	×
WS Max WS - TR200_36_0	▲
Ground	■
Levee	□
Bank Sta	●

Studio Scandicci Torrenti Greve-Vingone
River = Fosso Rigone Reach = Rigone 03 RS = 59 RI0005_A

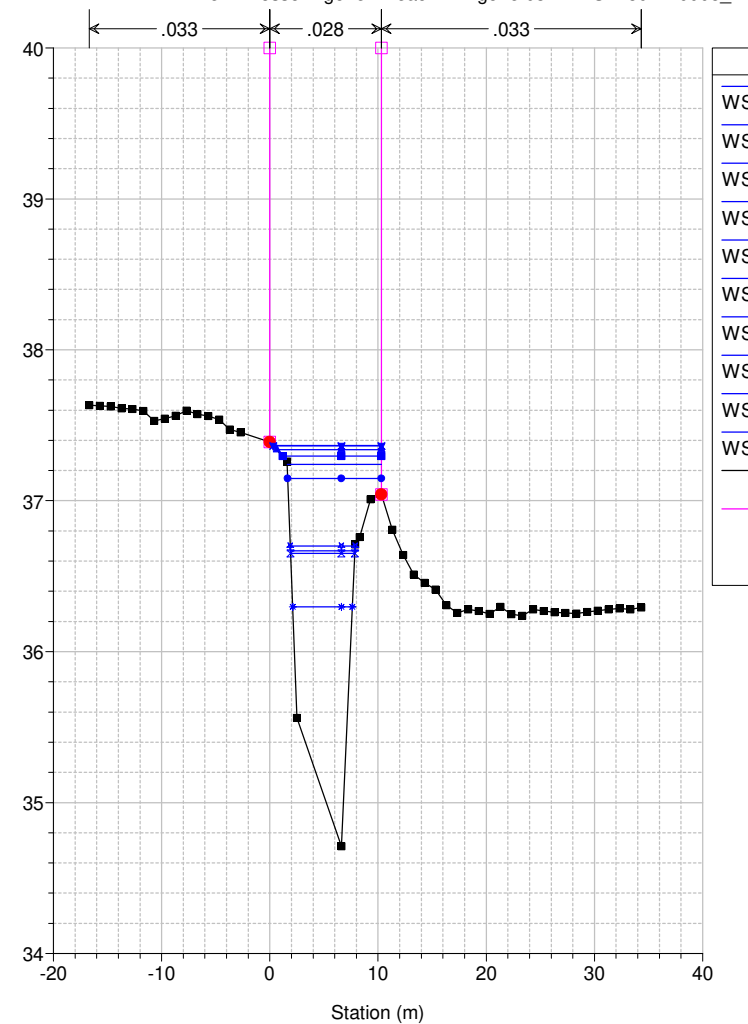

Legend	
WS Max WS - TR200_01_5	▲
WS Max WS - TR200_03_0	×
WS Max WS - TR200_01_0	▲
WS Max WS - TR200_06_0	■
WS Max WS - TR200_00_5	●
WS Max WS - TR200_09_0	●
WS Max WS - TR200_24_0	▲
WS Max WS - TR200_18_0	▲
WS Max WS - TR200_12_0	×
WS Max WS - TR200_36_0	▲
Ground	■
Levee	□
Bank Sta	●

Studio Scandicci Torrenti Greve-Vingone
River = Fosso Rigone Reach = Rigone 03 RS = 58 RI0005_B

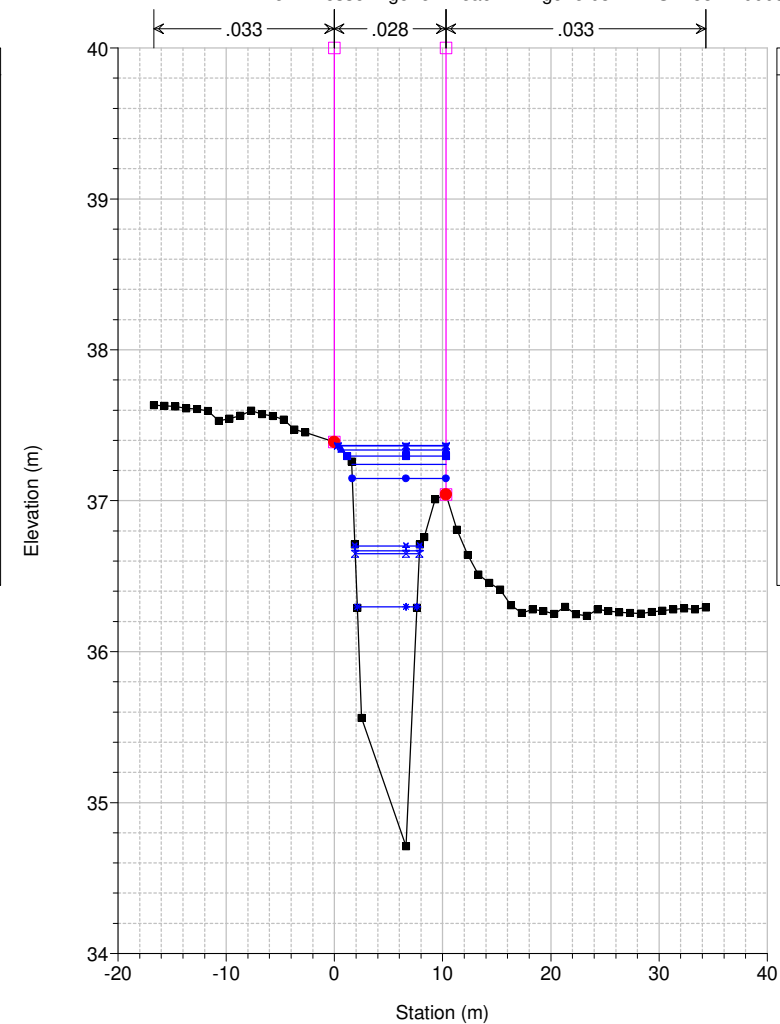

Legend	
WS Max WS - TR200_01_5	▲
WS Max WS - TR200_03_0	×
WS Max WS - TR200_01_0	▲
WS Max WS - TR200_06_0	■
WS Max WS - TR200_00_5	●
WS Max WS - TR200_09_0	●
WS Max WS - TR200_24_0	▲
WS Max WS - TR200_18_0	▲
WS Max WS - TR200_12_0	×
WS Max WS - TR200_36_0	▲
Ground	■
Levee	□
Bank Sta	●

Studio Scandicci Torrenti Greve-Vingone
River = Fosso Rigone Reach = Rigone 03 RS = 57.75 BR

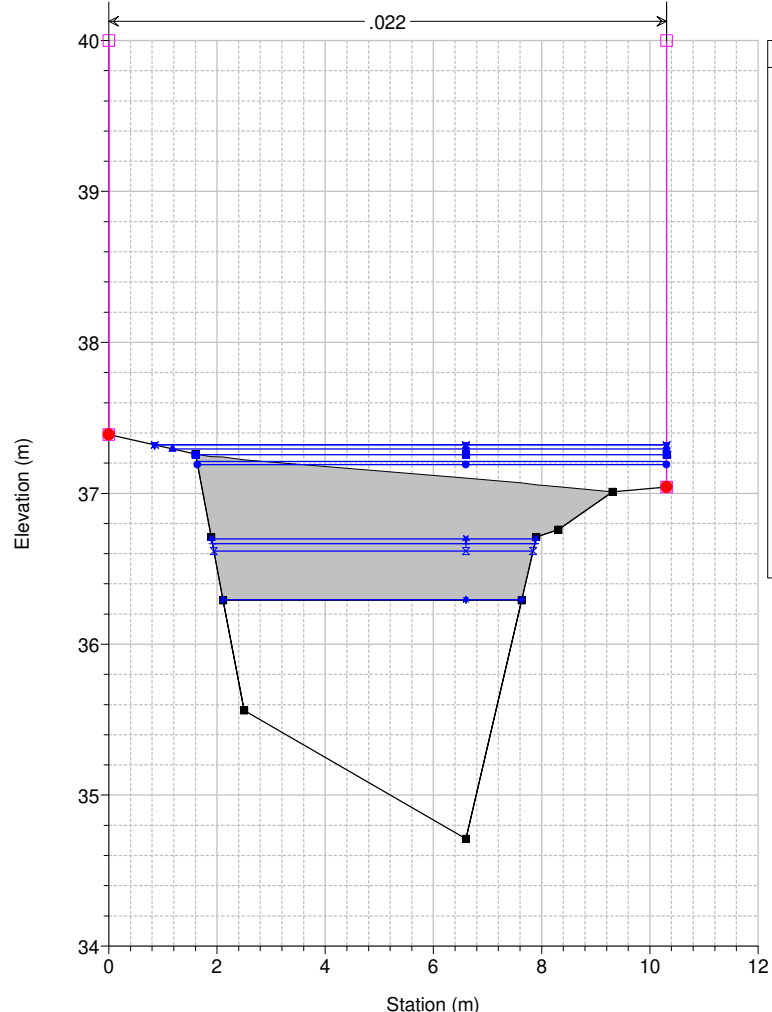

Legend

- WS Max WS - TR200_01_5
- WS Max WS - TR200_03_0
- WS Max WS - TR200_01_0
- WS Max WS - TR200_06_0
- WS Max WS - TR200_00_5
- WS Max WS - TR200_09_0
- WS Max WS - TR200_24_0
- WS Max WS - TR200_18_0
- WS Max WS - TR200_12_0
- WS Max WS - TR200_36_0
- Ground
- Levee
- Bank Sta

Studio Scandicci Torrenti Greve-Vingone
River = Fosso Rigone Reach = Rigone 03 RS = 57.75 BR

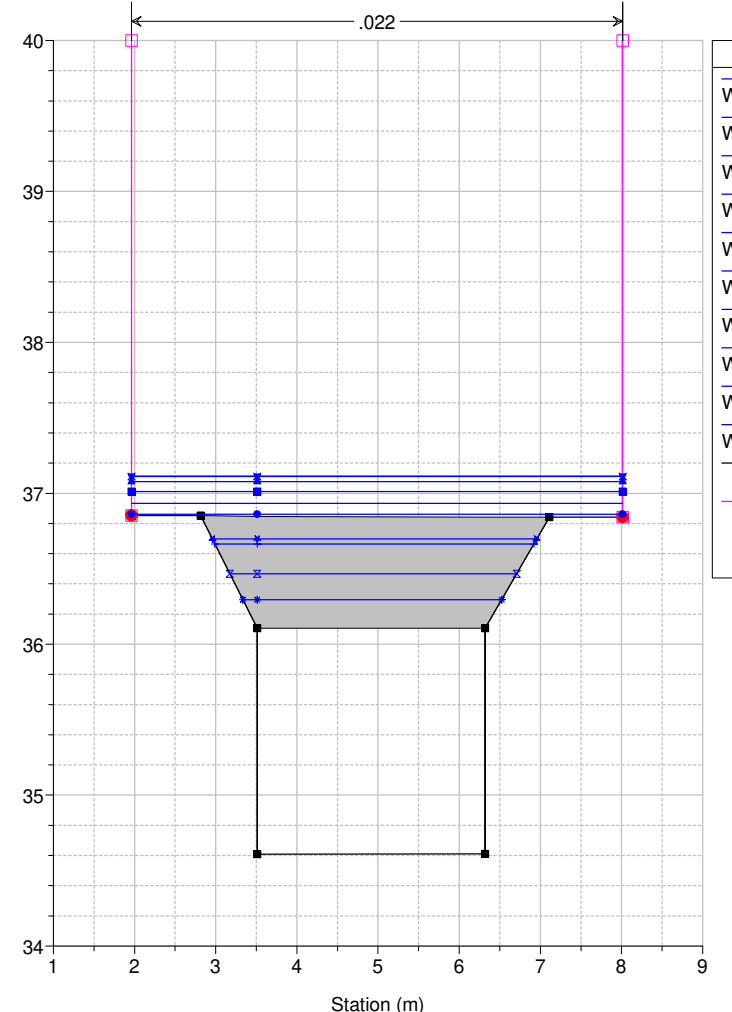

Legend

- WS Max WS - TR200_01_5
- WS Max WS - TR200_03_0
- WS Max WS - TR200_01_0
- WS Max WS - TR200_06_0
- WS Max WS - TR200_00_5
- WS Max WS - TR200_09_0
- WS Max WS - TR200_24_0
- WS Max WS - TR200_18_0
- WS Max WS - TR200_12_0
- WS Max WS - TR200_36_0
- Ground
- Levee
- Bank Sta

Studio Scandicci Torrenti Greve-Vingone
River = Fosso Rigone Reach = Rigone 03 RS = 57.4

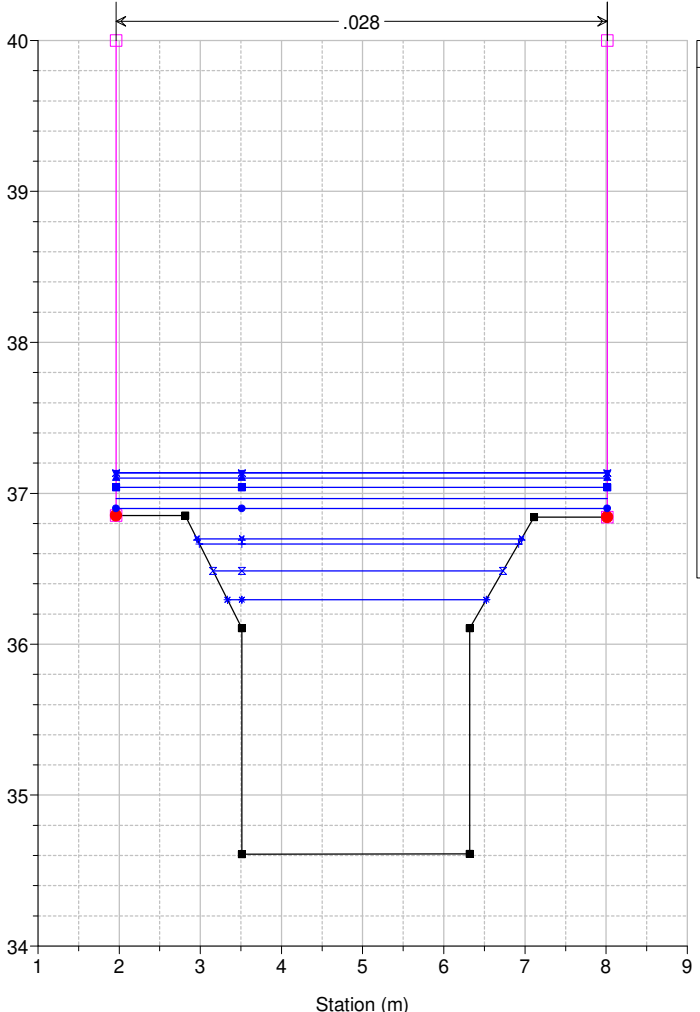

Legend

- WS Max WS - TR200_01_5
- WS Max WS - TR200_03_0
- WS Max WS - TR200_01_0
- WS Max WS - TR200_06_0
- WS Max WS - TR200_00_5
- WS Max WS - TR200_09_0
- WS Max WS - TR200_24_0
- WS Max WS - TR200_18_0
- WS Max WS - TR200_12_0
- WS Max WS - TR200_36_0
- Ground
- Levee
- Bank Sta

Studio Scandicci Torrenti Greve-Vingone
River = Fosso Rigone Reach = Rigone 03 RS = 57 RI0005_C

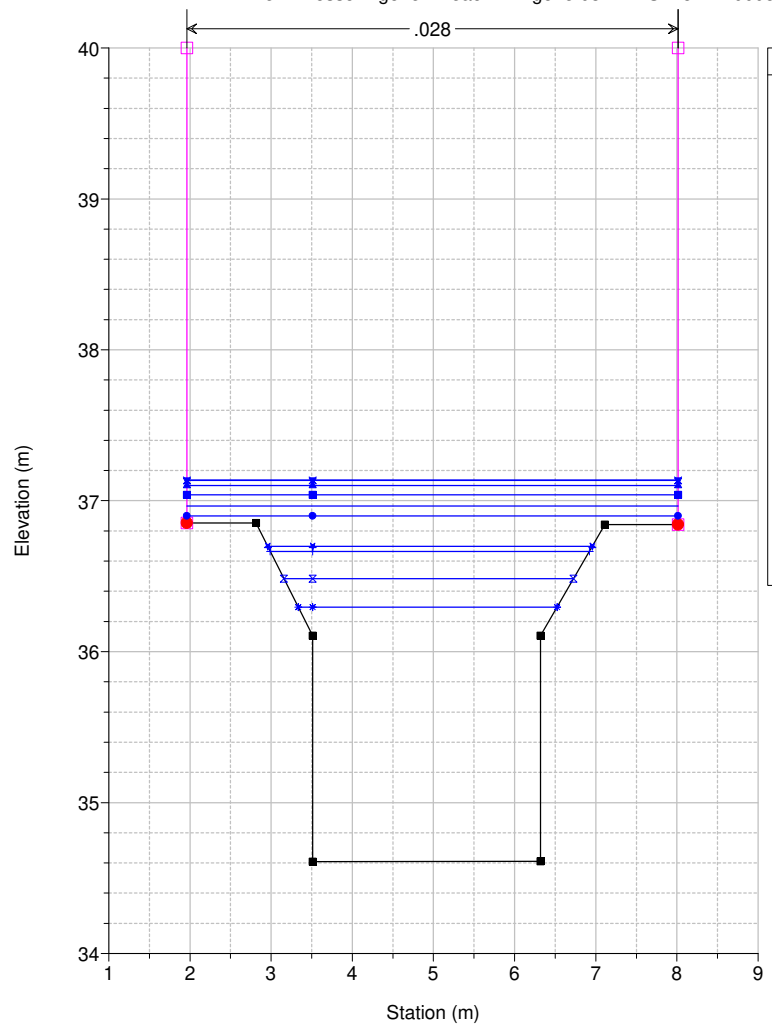

Legend

- WS Max WS - TR200_01_5
- WS Max WS - TR200_03_0
- WS Max WS - TR200_01_0
- WS Max WS - TR200_06_0
- WS Max WS - TR200_00_5
- WS Max WS - TR200_09_0
- WS Max WS - TR200_24_0
- WS Max WS - TR200_18_0
- WS Max WS - TR200_12_0
- WS Max WS - TR200_36_0
- Ground
- Levee
- Bank Sta

Studio Scandicci Torrenti Greve-Vingone
River = Fosso Rigone Reach = Rigone 03 RS = 56.75 Culv

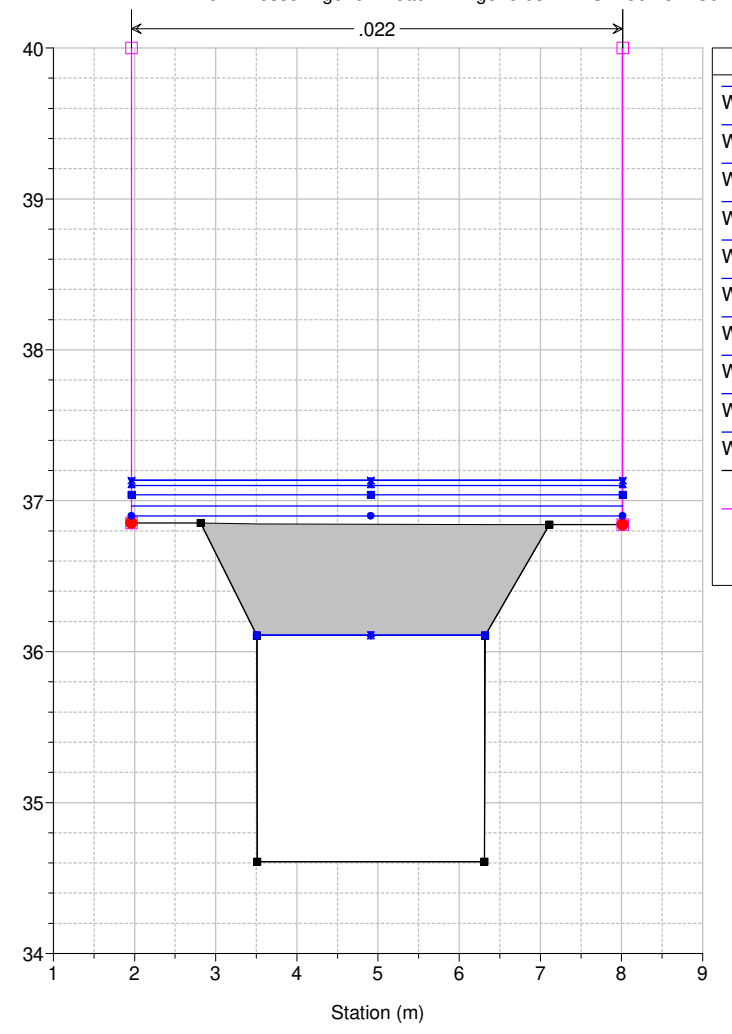

Legend

- WS Max WS - TR200_01_5
- WS Max WS - TR200_03_0
- WS Max WS - TR200_01_0
- WS Max WS - TR200_06_0
- WS Max WS - TR200_00_5
- WS Max WS - TR200_09_0
- WS Max WS - TR200_24_0
- WS Max WS - TR200_12_0
- WS Max WS - TR200_18_0
- WS Max WS - TR200_36_0
- Ground
- Levee
- Bank Sta

Studio Scandicci Torrenti Greve-Vingone
River = Fosso Rigone Reach = Rigone 03 RS = 56.75 Culv

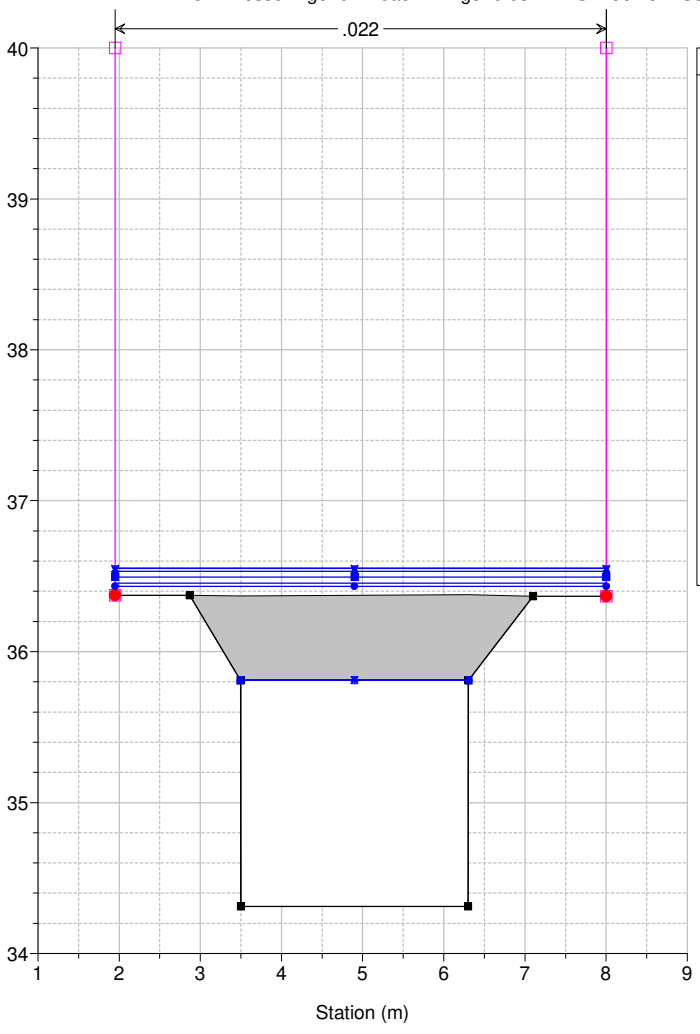

Legend

- WS Max WS - TR200_01_5
- WS Max WS - TR200_03_0
- WS Max WS - TR200_01_0
- WS Max WS - TR200_06_0
- WS Max WS - TR200_00_5
- WS Max WS - TR200_09_0
- WS Max WS - TR200_24_0
- WS Max WS - TR200_12_0
- WS Max WS - TR200_18_0
- WS Max WS - TR200_36_0
- Ground
- Levee
- Bank Sta

Studio Scandicci Torrenti Greve-Vingone
River = Fosso Rigone Reach = Rigone 03 RS = 56.4

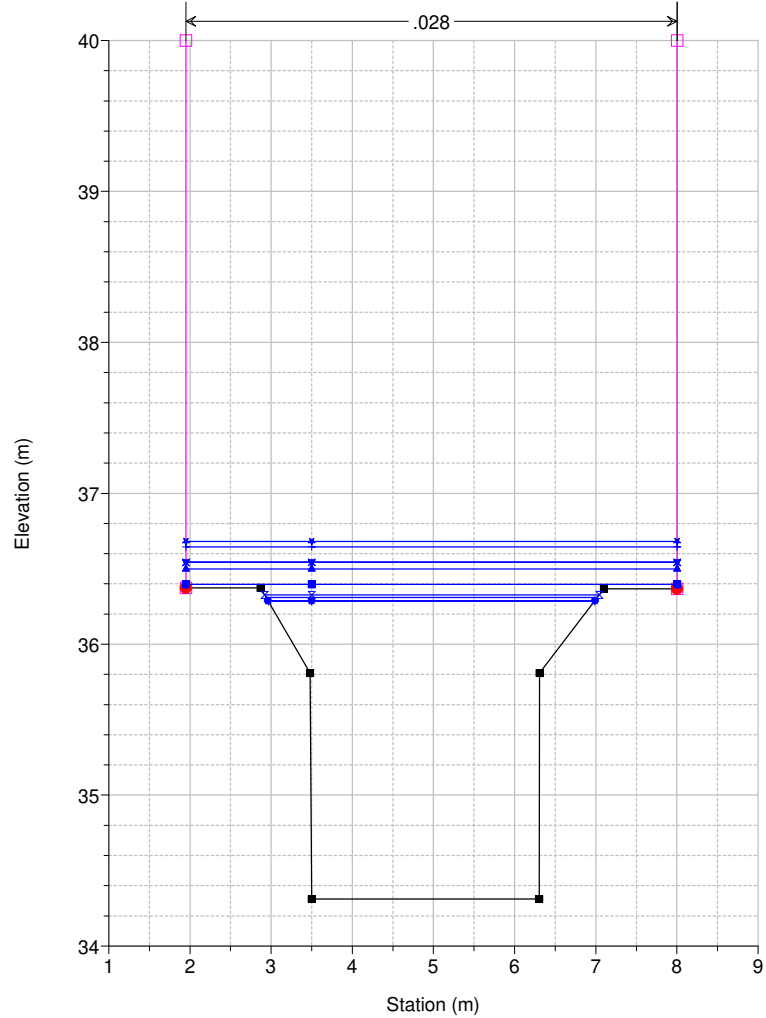

Legend	
WS Max WS - TR200_24_0	▲
WS Max WS - TR200_18_0	▲
WS Max WS - TR200_01_5	▲
WS Max WS - TR200_03_0	▲
WS Max WS - TR200_01_0	▲
WS Max WS - TR200_06_0	▲
WS Max WS - TR200_12_0	▲
WS Max WS - TR200_00_5	▲
WS Max WS - TR200_09_0	▲
WS Max WS - TR200_36_0	▲
Ground	■
Levee	□
Bank Sta	●

Studio Scandicci Torrenti Greve-Vingone
River = Fosso Rigone Reach = Rigone 03 RS = 56 RI0005_D

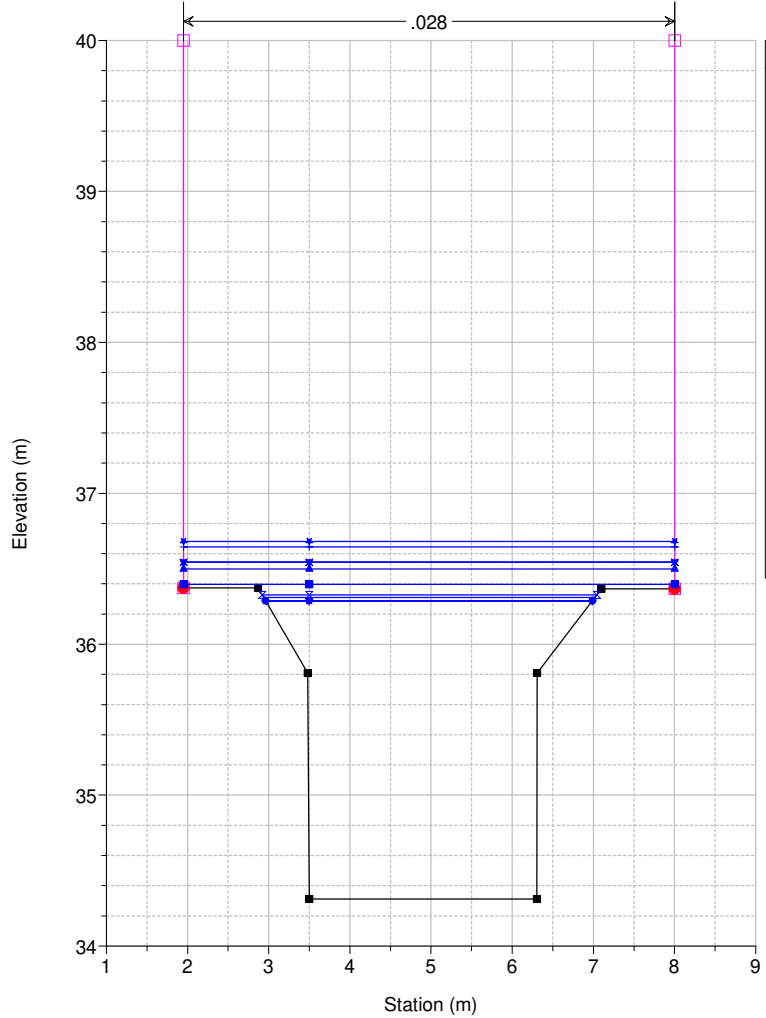

Legend	
WS Max WS - TR200_24_0	▲
WS Max WS - TR200_18_0	▲
WS Max WS - TR200_01_5	▲
WS Max WS - TR200_03_0	▲
WS Max WS - TR200_01_0	▲
WS Max WS - TR200_06_0	▲
WS Max WS - TR200_12_0	▲
WS Max WS - TR200_00_5	▲
WS Max WS - TR200_09_0	▲
WS Max WS - TR200_36_0	▲
Ground	■
Levee	□
Bank Sta	●

Studio Scandicci Torrenti Greve-Vingone
River = Fosso Rigone Reach = Rigone 03 RS = 55.75 BR

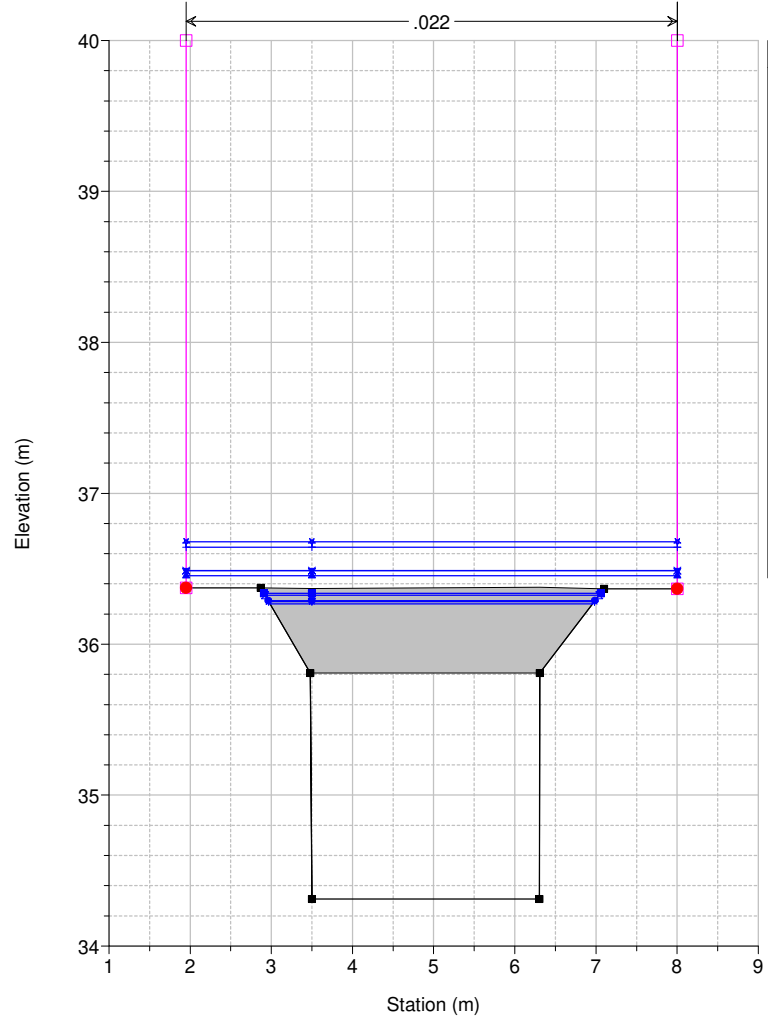

Legend	
WS Max WS - TR200_24_0	▲
WS Max WS - TR200_18_0	▲
WS Max WS - TR200_01_5	▲
WS Max WS - TR200_03_0	▲
WS Max WS - TR200_01_0	▲
WS Max WS - TR200_06_0	▲
WS Max WS - TR200_12_0	▲
WS Max WS - TR200_09_0	▲
WS Max WS - TR200_36_0	▲
WS Max WS - TR200_00_5	▲
Ground	■
Levee	□
Bank Sta	●

Studio Scandicci Torrenti Greve-Vingone
River = Fosso Rigone Reach = Rigone 03 RS = 55.75 BR

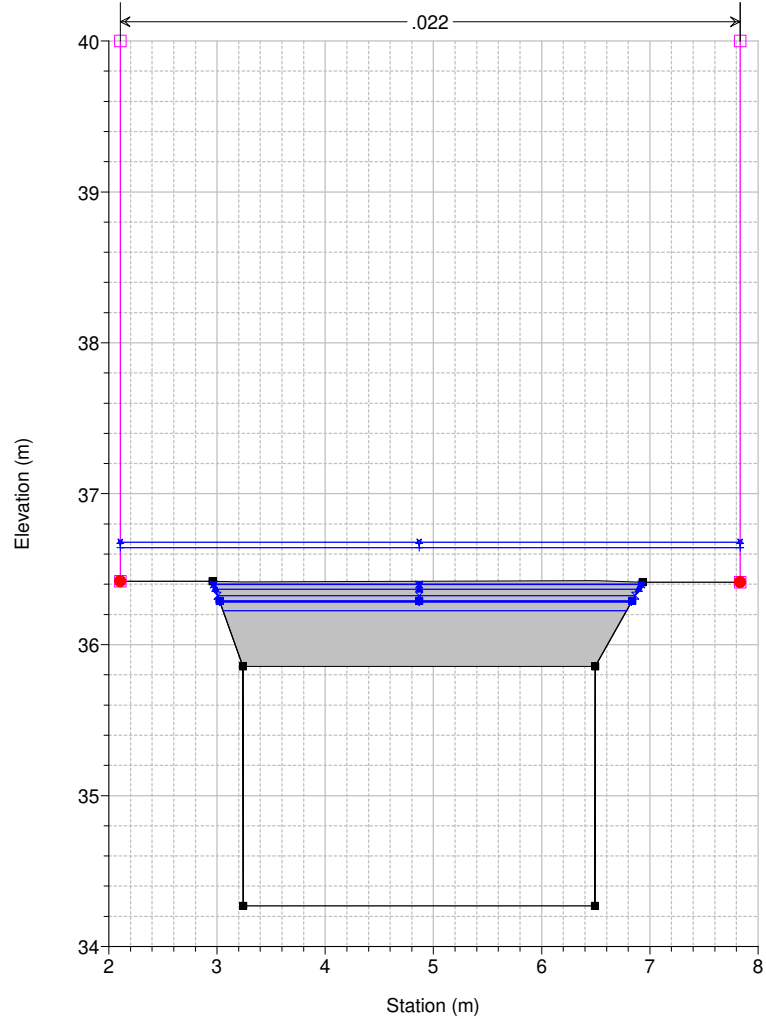

Legend	
WS Max WS - TR200_24_0	▲
WS Max WS - TR200_18_0	▲
WS Max WS - TR200_01_5	▲
WS Max WS - TR200_03_0	▲
WS Max WS - TR200_01_0	▲
WS Max WS - TR200_12_0	▲
WS Max WS - TR200_06_0	▲
WS Max WS - TR200_09_0	▲
WS Max WS - TR200_36_0	▲
WS Max WS - TR200_00_5	▲
Ground	■
Levee	□
Bank Sta	●

Studio Scandicci Torrenti Greve-Vingone
River = Fosso Rigone Reach = Rigone 03 RS = 55.4

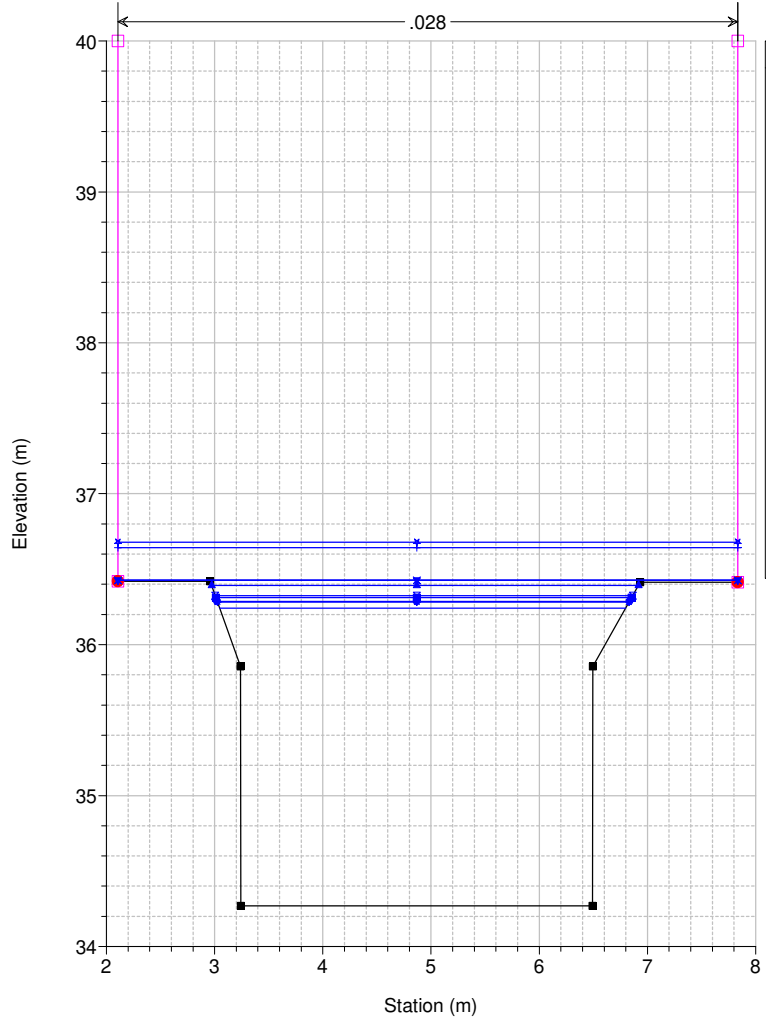

Legend	
WS Max WS - TR200_24_0	▲
WS Max WS - TR200_18_0	▲
WS Max WS - TR200_01_5	▲
WS Max WS - TR200_03_0	▲
WS Max WS - TR200_01_0	▲
WS Max WS - TR200_12_0	▲
WS Max WS - TR200_06_0	▲
WS Max WS - TR200_09_0	▲
WS Max WS - TR200_36_0	▲
WS Max WS - TR200_00_5	▲
Ground	■
Levee	□
Bank Sta	●

Studio Scandicci Torrenti Greve-Vingone
River = Fosso Rigone Reach = Rigone 03 RS = 55 RI0006_A

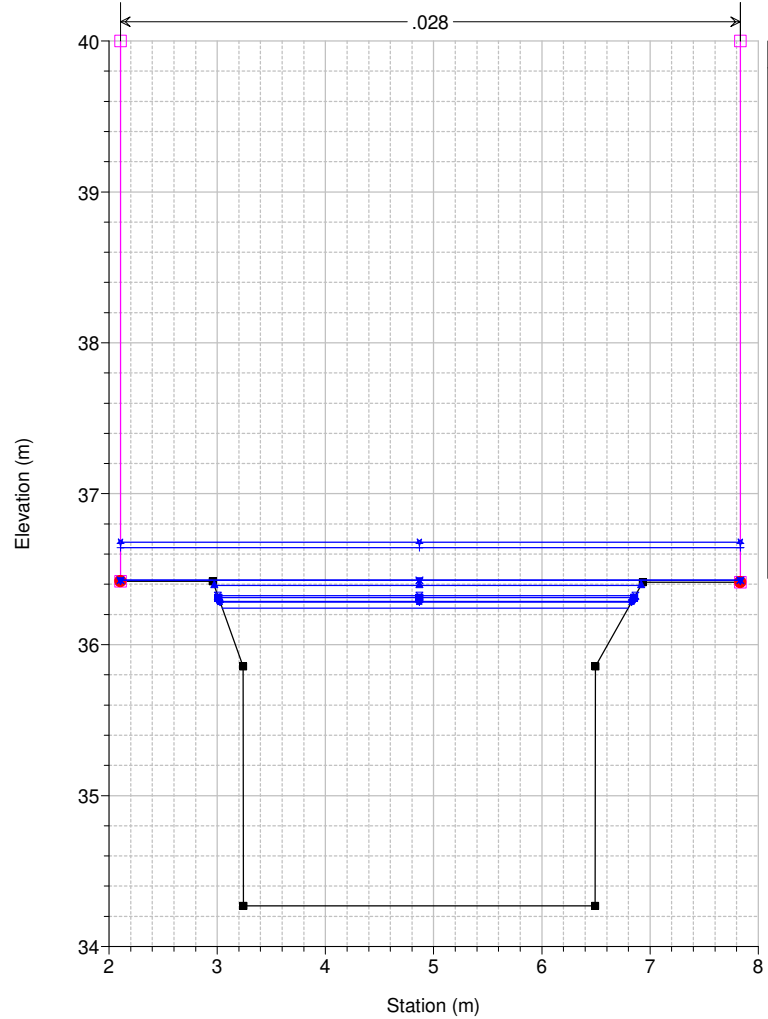

Legend	
WS Max WS - TR200_24_0	▲
WS Max WS - TR200_18_0	▲
WS Max WS - TR200_01_5	▲
WS Max WS - TR200_03_0	▲
WS Max WS - TR200_01_0	▲
WS Max WS - TR200_12_0	▲
WS Max WS - TR200_06_0	▲
WS Max WS - TR200_09_0	▲
WS Max WS - TR200_36_0	▲
WS Max WS - TR200_00_5	▲
Ground	■
Levee	□
Bank Sta	●

Studio Scandicci Torrenti Greve-Vingone
River = Fosso Rigone Reach = Rigone 03 RS = 54.5 Culv

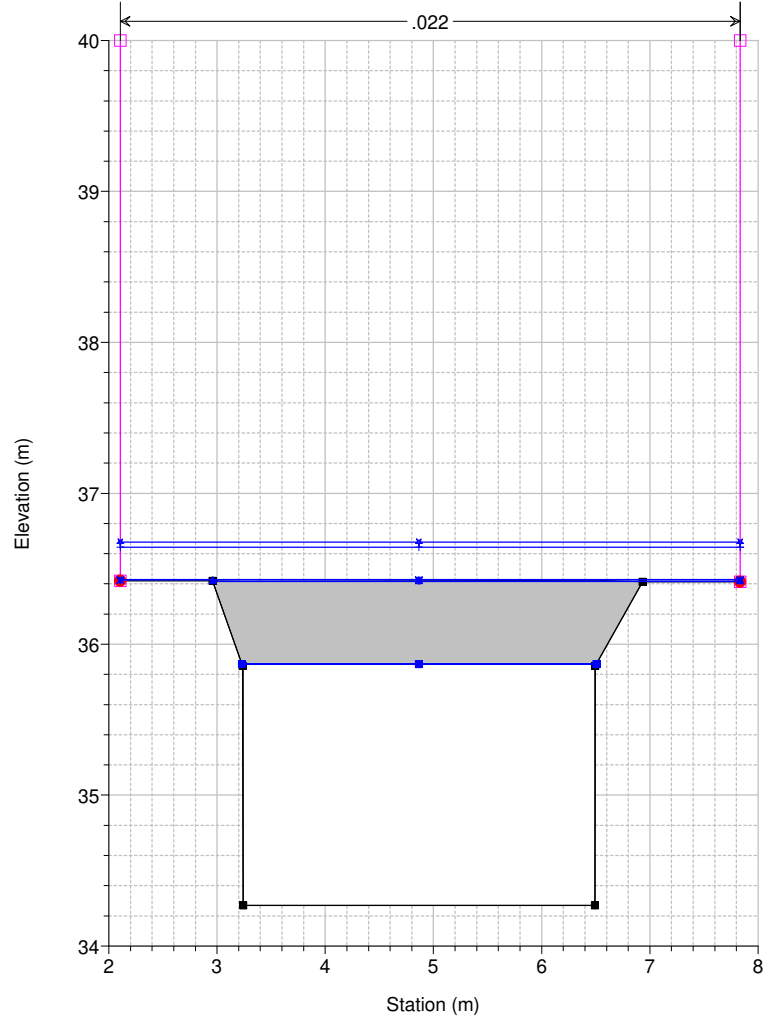

Legend	
WS Max WS - TR200_24_0	+
WS Max WS - TR200_18_0	+
WS Max WS - TR200_01_5	+
WS Max WS - TR200_03_0	+
WS Max WS - TR200_01_0	+
WS Max WS - TR200_09_0	+
WS Max WS - TR200_12_0	+
WS Max WS - TR200_06_0	+
WS Max WS - TR200_00_5	+
WS Max WS - TR200_36_0	+
Ground	■
Levee	□
Bank Sta	●

Studio Scandicci Torrenti Greve-Vingone
River = Fosso Rigone Reach = Rigone 03 RS = 54.5 Culv

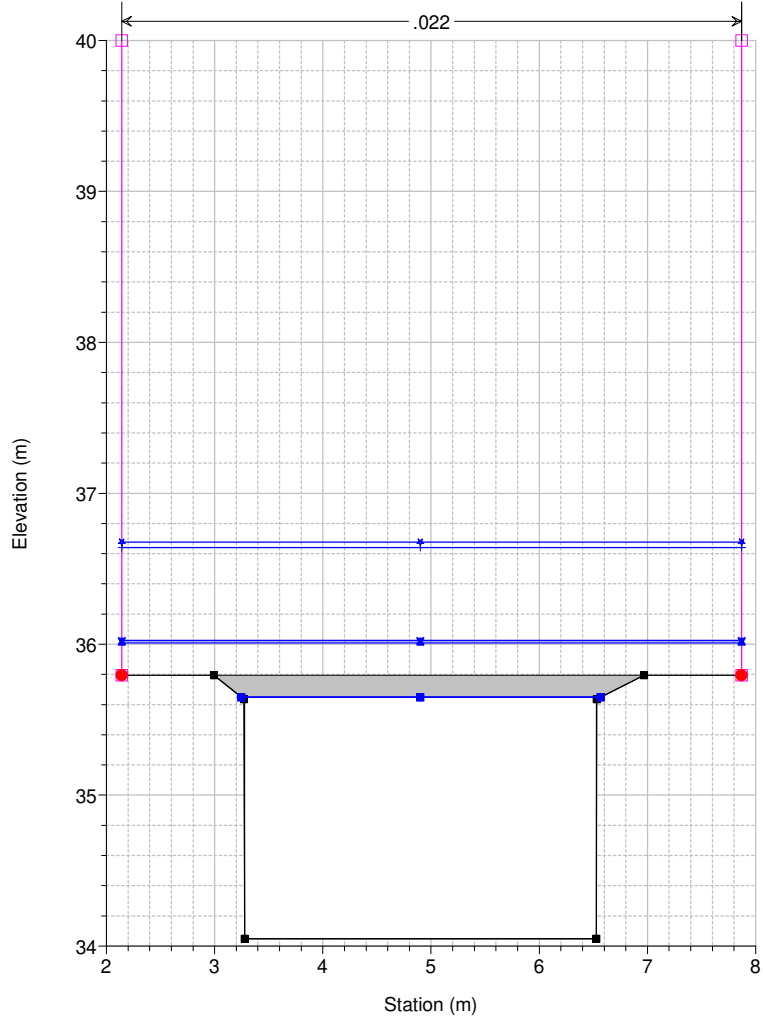

Legend	
WS Max WS - TR200_24_0	+
WS Max WS - TR200_18_0	+
WS Max WS - TR200_01_5	+
WS Max WS - TR200_03_0	+
WS Max WS - TR200_01_0	+
WS Max WS - TR200_09_0	+
WS Max WS - TR200_12_0	+
WS Max WS - TR200_06_0	+
WS Max WS - TR200_00_5	+
WS Max WS - TR200_36_0	+
Ground	■
Levee	□
Bank Sta	●

Studio Scandicci Torrenti Greve-Vingone
River = Fosso Rigone Reach = Rigone 03 RS = 54.4

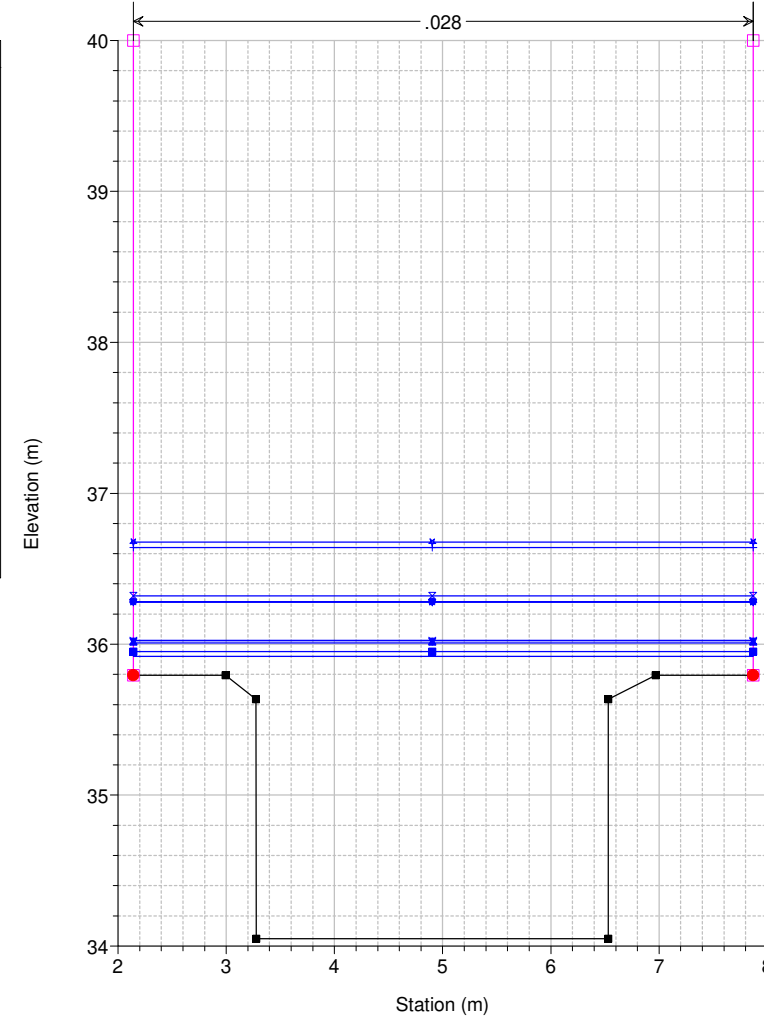

Legend	
WS Max WS - TR200_24_0	+
WS Max WS - TR200_18_0	+
WS Max WS - TR200_12_0	+
WS Max WS - TR200_09_0	+
WS Max WS - TR200_36_0	+
WS Max WS - TR200_01_5	+
WS Max WS - TR200_03_0	+
WS Max WS - TR200_01_0	+
WS Max WS - TR200_06_0	+
WS Max WS - TR200_00_5	+
Ground	■
Levee	□
Bank Sta	●

Studio Scandicci Torrenti Greve-Vingone
River = Fosso Rigone Reach = Rigone 03 RS = 54 RI0006_B

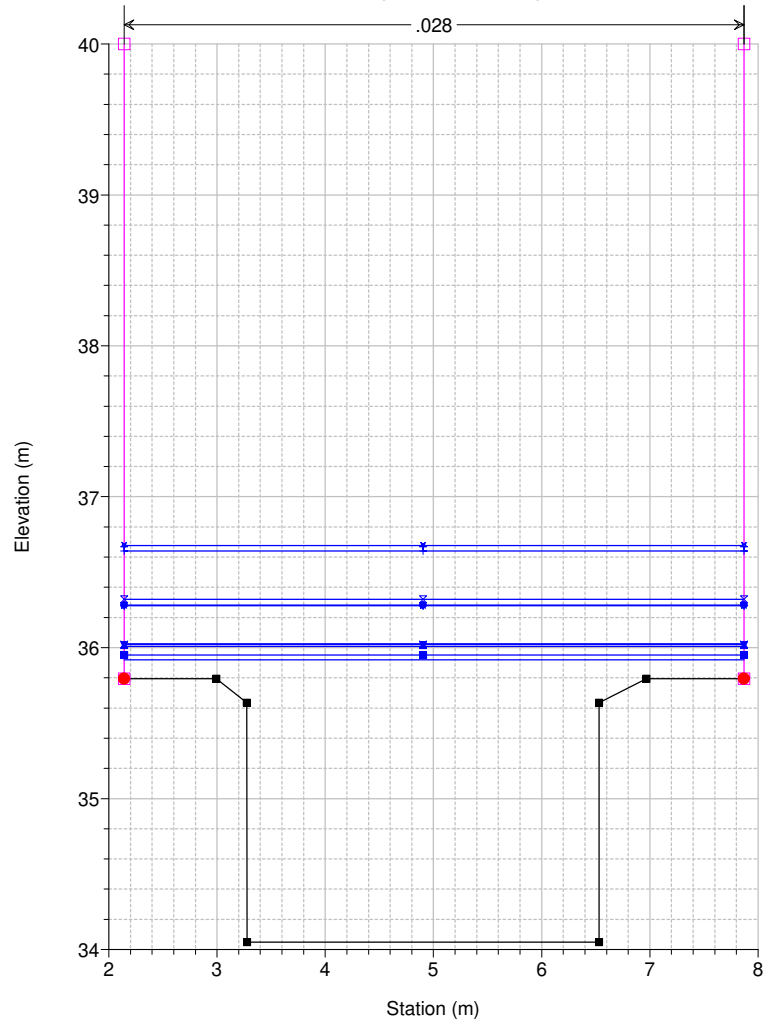

Legend	
WS Max WS - TR200_24_0	+
WS Max WS - TR200_18_0	+
WS Max WS - TR200_12_0	+
WS Max WS - TR200_09_0	+
WS Max WS - TR200_36_0	+
WS Max WS - TR200_01_5	+
WS Max WS - TR200_03_0	+
WS Max WS - TR200_01_0	+
WS Max WS - TR200_06_0	+
WS Max WS - TR200_00_5	+
Ground	■
Levee	□
Bank Sta	●

Studio Scandicci Torrenti Greve-Vingone
River = Fosso Rigone Reach = Rigone 03 RS = 53.5 BR

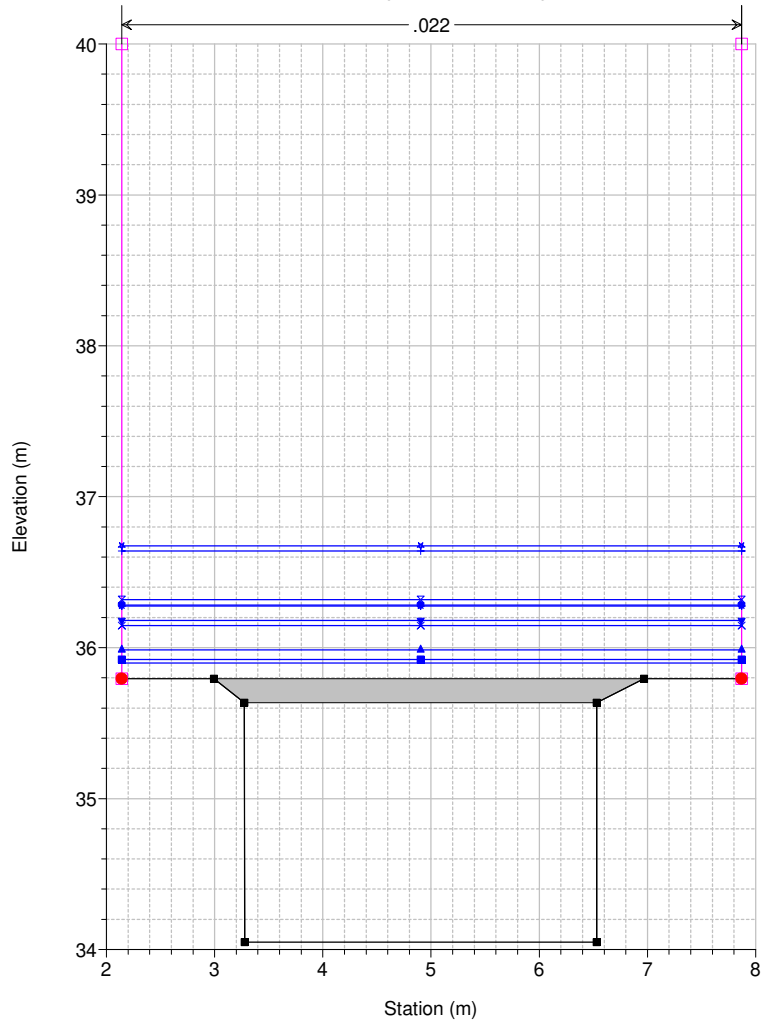

Legend	
WS Max WS - TR200_24_0	+
WS Max WS - TR200_18_0	+
WS Max WS - TR200_12_0	+
WS Max WS - TR200_09_0	+
WS Max WS - TR200_36_0	+
WS Max WS - TR200_01_5	+
WS Max WS - TR200_03_0	+
WS Max WS - TR200_01_0	+
WS Max WS - TR200_06_0	+
WS Max WS - TR200_00_5	+
Ground	■
Levee	□
Bank Sta	●

Studio Scandicci Torrenti Greve-Vingone
River = Fosso Rigone Reach = Rigone 03 RS = 53.5 BR

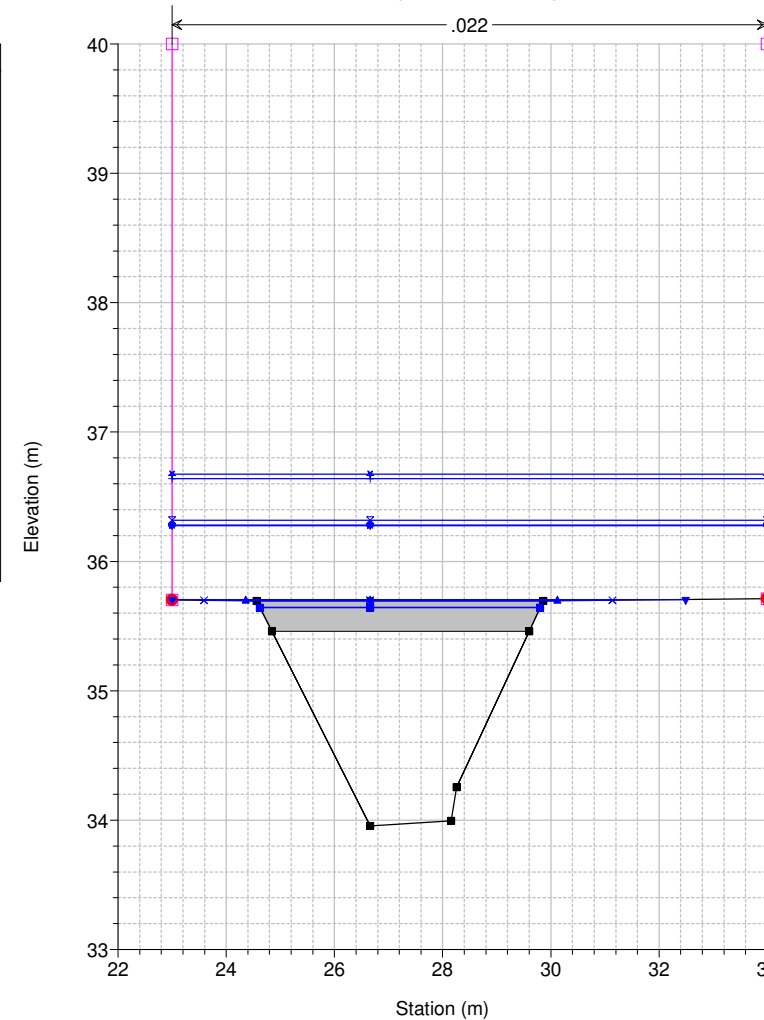

Legend	
WS Max WS - TR200_24_0	+
WS Max WS - TR200_18_0	+
WS Max WS - TR200_12_0	+
WS Max WS - TR200_09_0	+
WS Max WS - TR200_36_0	+
WS Max WS - TR200_01_5	+
WS Max WS - TR200_03_0	+
WS Max WS - TR200_01_0	+
WS Max WS - TR200_06_0	+
WS Max WS - TR200_00_5	+
Ground	■
Levee	□
Bank Sta	●

Studio Scandicci Torrenti Greve-Vingone
River = Fosso Rigone Reach = Rigone 03 RS = 53 RI0006_C

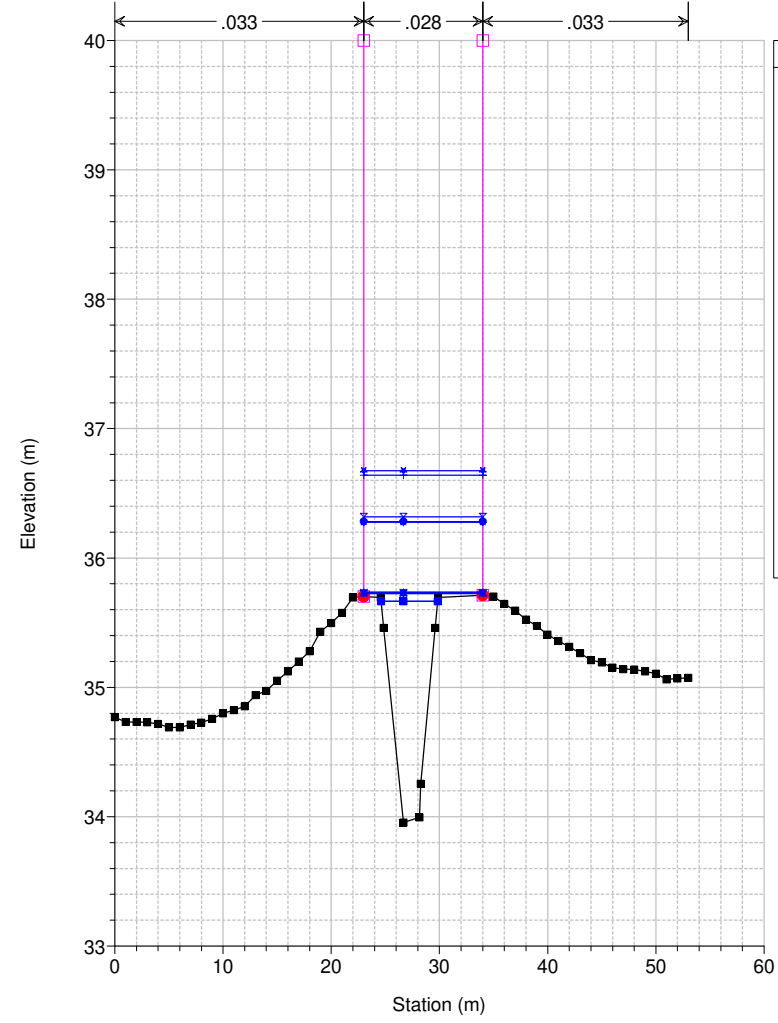

Legend	
WS Max WS - TR200_24_0	+
WS Max WS - TR200_18_0	+
WS Max WS - TR200_12_0	+
WS Max WS - TR200_09_0	+
WS Max WS - TR200_36_0	+
WS Max WS - TR200_01_5	+
WS Max WS - TR200_03_0	+
WS Max WS - TR200_01_0	+
WS Max WS - TR200_06_0	+
WS Max WS - TR200_00_5	+
Ground	■
Levee	□
Bank Sta	●

Studio Scandicci Torrenti Greve-Vingone
River = Fosso Rigone Reach = Rigone 03 RS = 52 RI0006_D

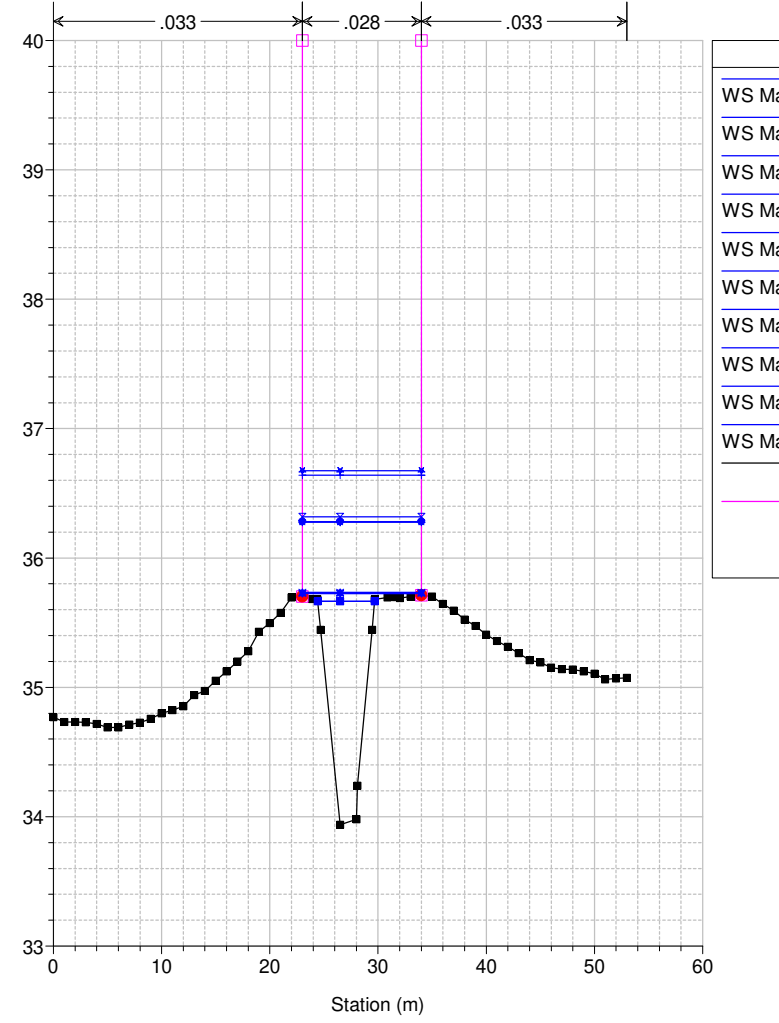

Legend	
WS Max WS - TR200_24_0	+
WS Max WS - TR200_18_0	+
WS Max WS - TR200_12_0	+
WS Max WS - TR200_09_0	+
WS Max WS - TR200_36_0	+
WS Max WS - TR200_01_5	+
WS Max WS - TR200_03_0	+
WS Max WS - TR200_01_0	+
WS Max WS - TR200_06_0	+
WS Max WS - TR200_00_5	+
Ground	■
Levee	□
Bank Sta	●

Studio Scandicci Torrenti Greve-Vingone
River = Fosso Rigone Reach = Rigone 03 RS = 51 RI0007_A

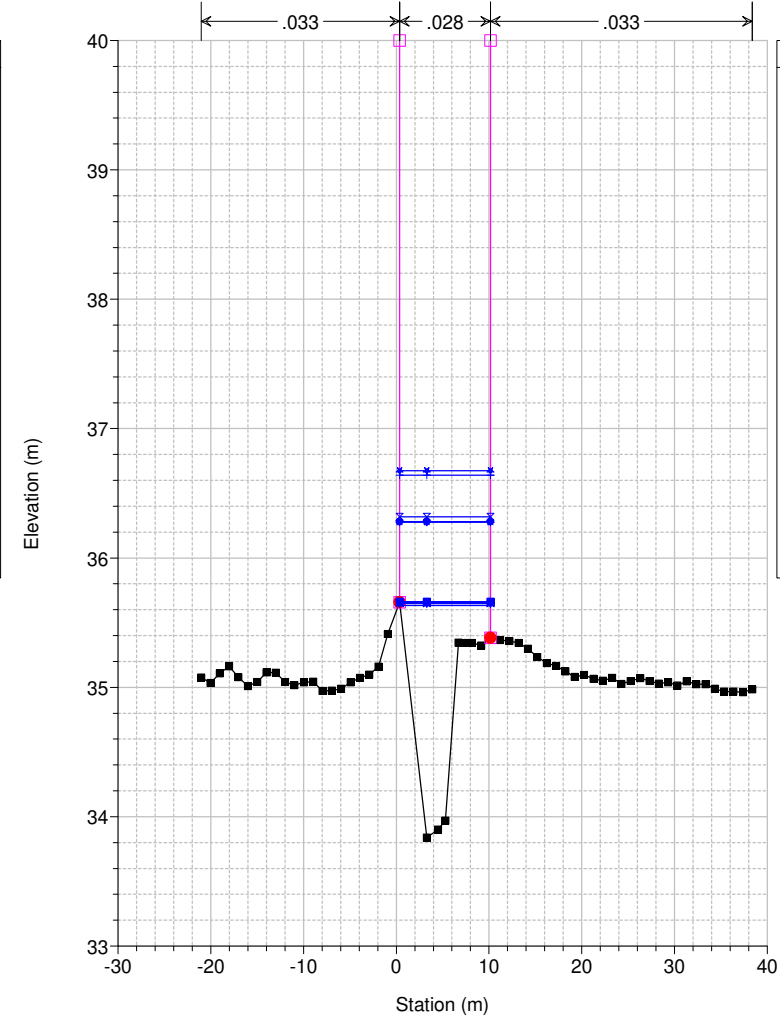

Legend	
WS Max WS - TR200_24_0	+
WS Max WS - TR200_18_0	+
WS Max WS - TR200_12_0	+
WS Max WS - TR200_09_0	+
WS Max WS - TR200_36_0	+
WS Max WS - TR200_06_0	+
WS Max WS - TR200_01_5	+
WS Max WS - TR200_03_0	+
WS Max WS - TR200_01_0	+
WS Max WS - TR200_00_5	+
Ground	■
Levee	□
Bank Sta	●

Studio Scandicci Torrenti Greve-Vingone
River = Fosso Rigone Reach = Rigone 03 RS = 50 RI0007_B

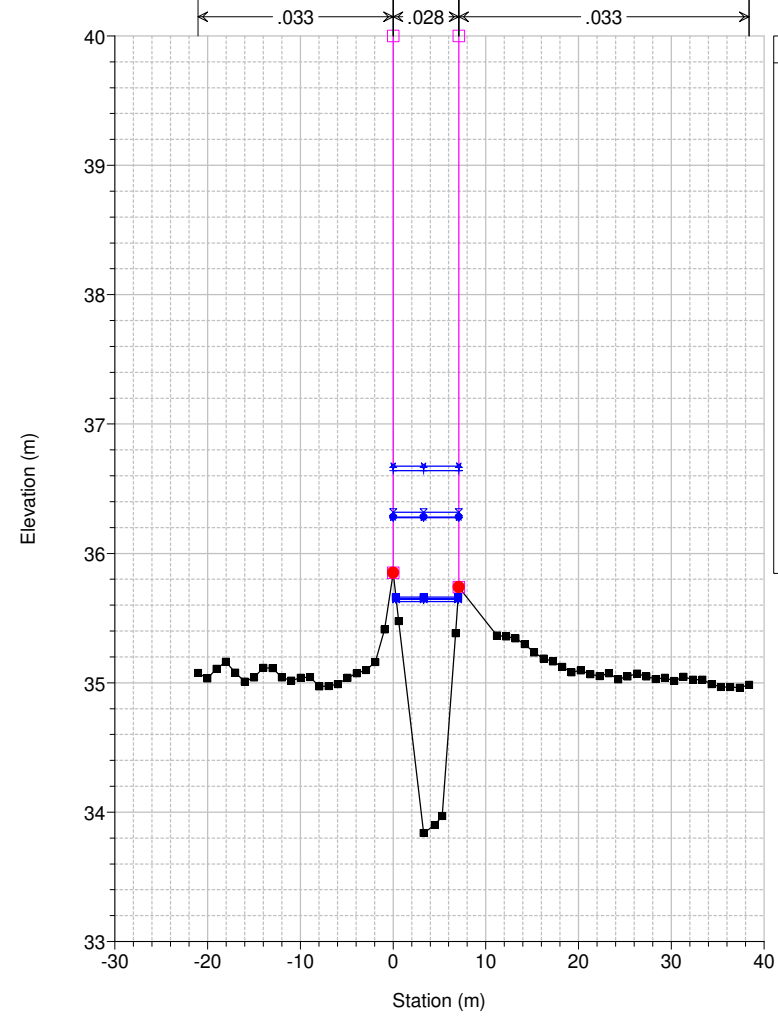

Legend	
WS Max WS - TR200_24_0	+
WS Max WS - TR200_18_0	+
WS Max WS - TR200_12_0	+
WS Max WS - TR200_09_0	+
WS Max WS - TR200_36_0	+
WS Max WS - TR200_06_0	+
WS Max WS - TR200_01_5	+
WS Max WS - TR200_03_0	+
WS Max WS - TR200_01_0	+
WS Max WS - TR200_00_5	+
Ground	■
Levee	□
Bank Sta	●

Studio Scandicci Torrenti Greve-Vingone
River = Fosso Rigone Reach = Rigone 03 RS = 49.5 BR

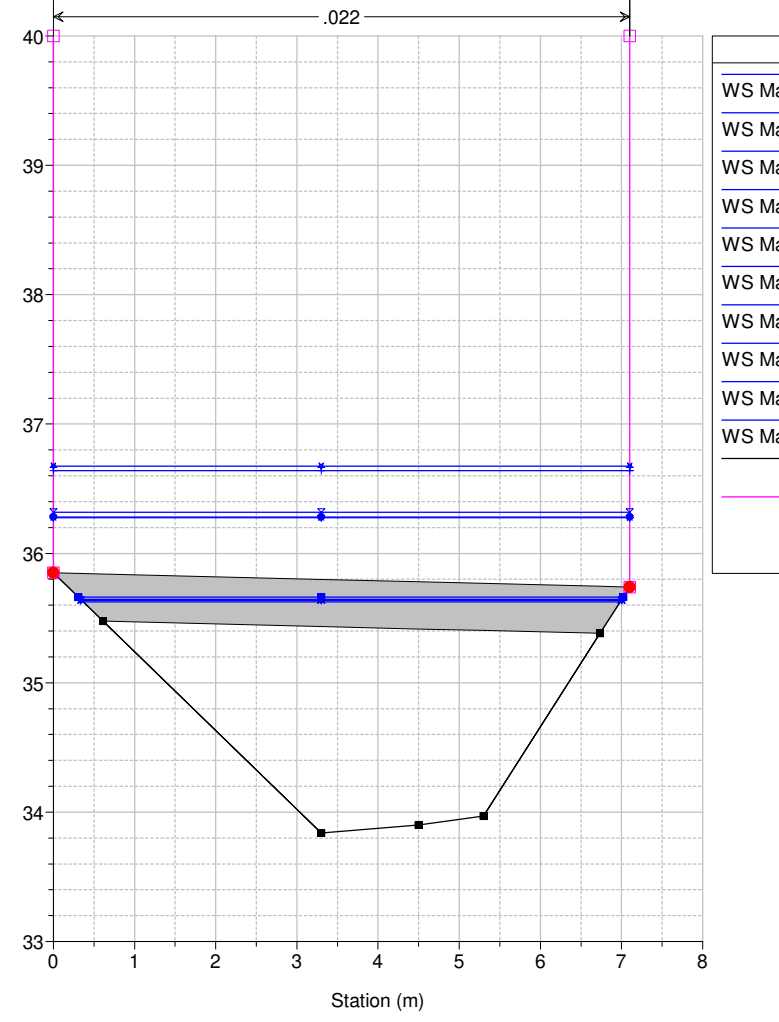

Legend	
WS Max WS - TR200_24_0	+
WS Max WS - TR200_18_0	+
WS Max WS - TR200_12_0	+
WS Max WS - TR200_09_0	+
WS Max WS - TR200_36_0	+
WS Max WS - TR200_06_0	+
WS Max WS - TR200_01_5	+
WS Max WS - TR200_03_0	+
WS Max WS - TR200_01_0	+
WS Max WS - TR200_00_5	+
Ground	■
Levee	□
Bank Sta	●

Studio Scandicci Torrenti Greve-Vingone
River = Fosso Rigone Reach = Rigone 03 RS = 49.5 BR

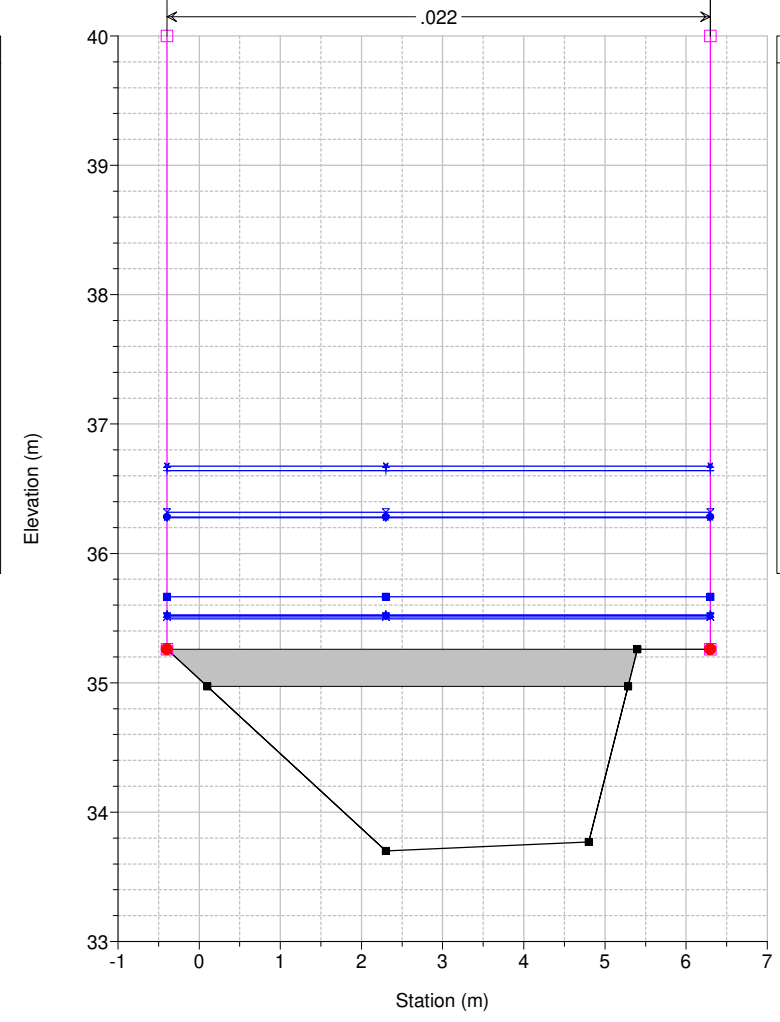

Legend	
WS Max WS - TR200_24_0	+
WS Max WS - TR200_18_0	+
WS Max WS - TR200_12_0	+
WS Max WS - TR200_09_0	+
WS Max WS - TR200_36_0	+
WS Max WS - TR200_06_0	+
WS Max WS - TR200_01_5	+
WS Max WS - TR200_01_0	+
WS Max WS - TR200_03_0	+
WS Max WS - TR200_00_5	+
Ground	■
Levee	□
Bank Sta	●

Studio Scandicci Torrenti Greve-Vingone
River = Fosso Rigone Reach = Rigone 03 RS = 49 RI0008_C

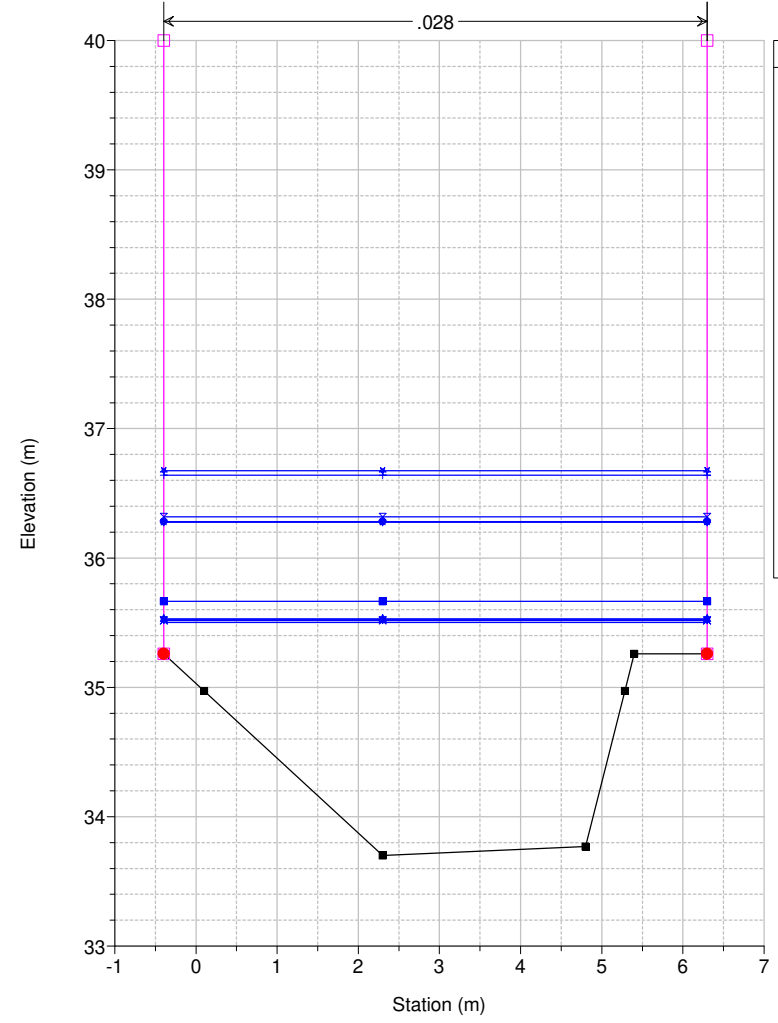

Legend	
WS Max WS - TR200_24_0	▲
WS Max WS - TR200_18_0	+
WS Max WS - TR200_12_0	✕
WS Max WS - TR200_09_0	●
WS Max WS - TR200_36_0	■
WS Max WS - TR200_06_0	▼
WS Max WS - TR200_01_5	▽
WS Max WS - TR200_01_0	▲
WS Max WS - TR200_03_0	✕
WS Max WS - TR200_00_5	■
Ground	■
Levee	□
Bank Sta	●

Studio Scandicci Torrenti Greve-Vingone
River = Fosso Rigone Reach = Rigone 03 RS = 48 RI0008_D

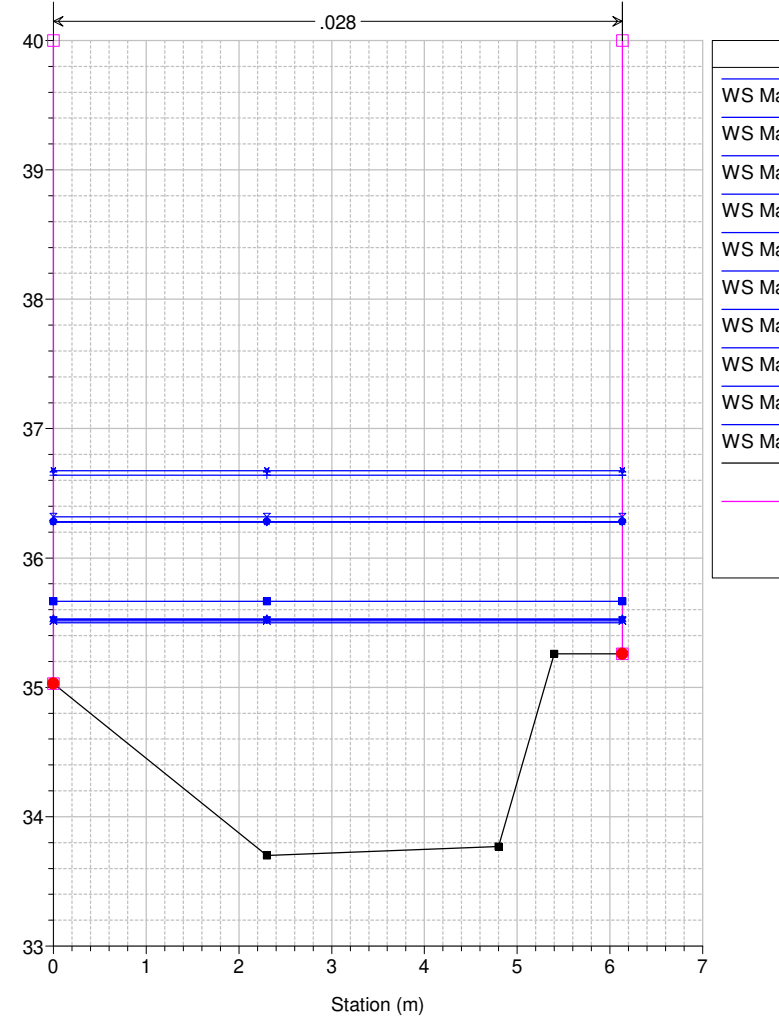

Legend	
WS Max WS - TR200_24_0	▲
WS Max WS - TR200_18_0	+
WS Max WS - TR200_12_0	✕
WS Max WS - TR200_09_0	●
WS Max WS - TR200_36_0	■
WS Max WS - TR200_06_0	▼
WS Max WS - TR200_01_5	▽
WS Max WS - TR200_01_0	▲
WS Max WS - TR200_03_0	✕
WS Max WS - TR200_00_5	■
Ground	■
Levee	□
Bank Sta	●

Studio Scandicci Torrenti Greve-Vingone
River = Fosso Rigone Reach = Rigone 03 RS = 47 RI0009__

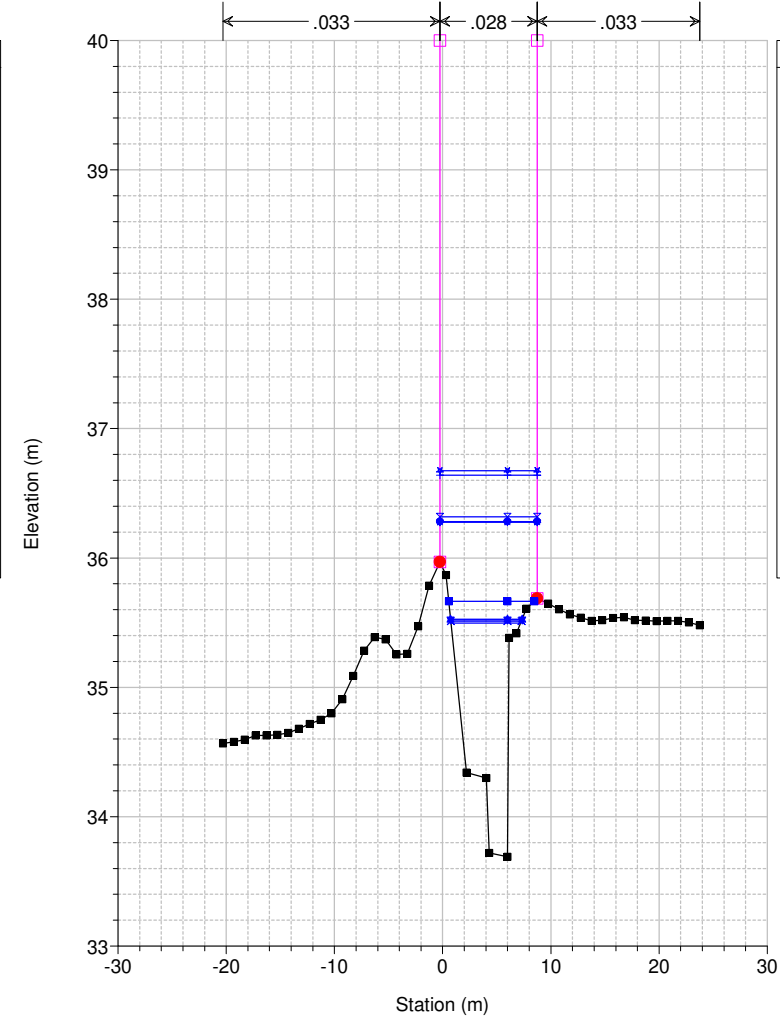

Legend	
WS Max WS - TR200_24_0	▲
WS Max WS - TR200_18_0	+
WS Max WS - TR200_12_0	✕
WS Max WS - TR200_09_0	●
WS Max WS - TR200_36_0	■
WS Max WS - TR200_06_0	▼
WS Max WS - TR200_01_5	▽
WS Max WS - TR200_01_0	▲
WS Max WS - TR200_03_0	✕
WS Max WS - TR200_00_5	■
Ground	■
Levee	□
Bank Sta	●

Studio Scandicci Torrenti Greve-Vingone
River = Fosso Rigone Reach = Rigone 03 RS = 46 RI0010__

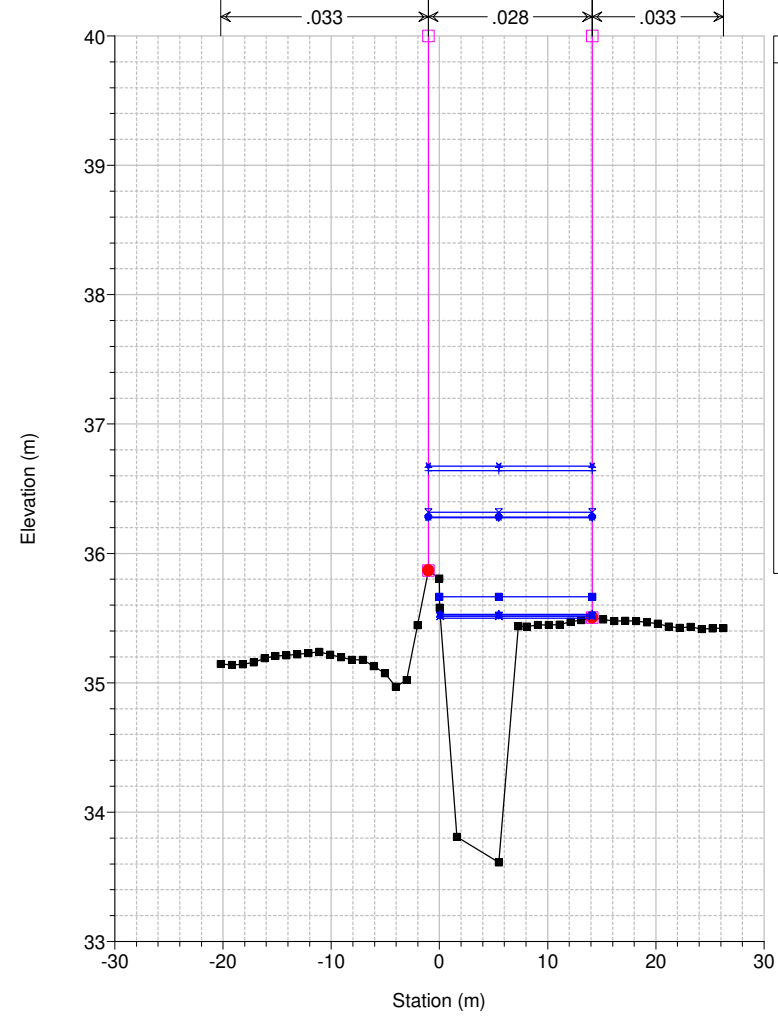

Legend	
WS Max WS - TR200_24_0	▲
WS Max WS - TR200_18_0	+
WS Max WS - TR200_12_0	✕
WS Max WS - TR200_09_0	●
WS Max WS - TR200_36_0	■
WS Max WS - TR200_06_0	▼
WS Max WS - TR200_01_5	▽
WS Max WS - TR200_01_0	▲
WS Max WS - TR200_03_0	✕
WS Max WS - TR200_00_5	■
Ground	■
Levee	□
Bank Sta	●

Studio Scandicci Torrenti Greve-Vingone
River = Fosso Rigone Reach = Rigone 03 RS = 45 RI0011__

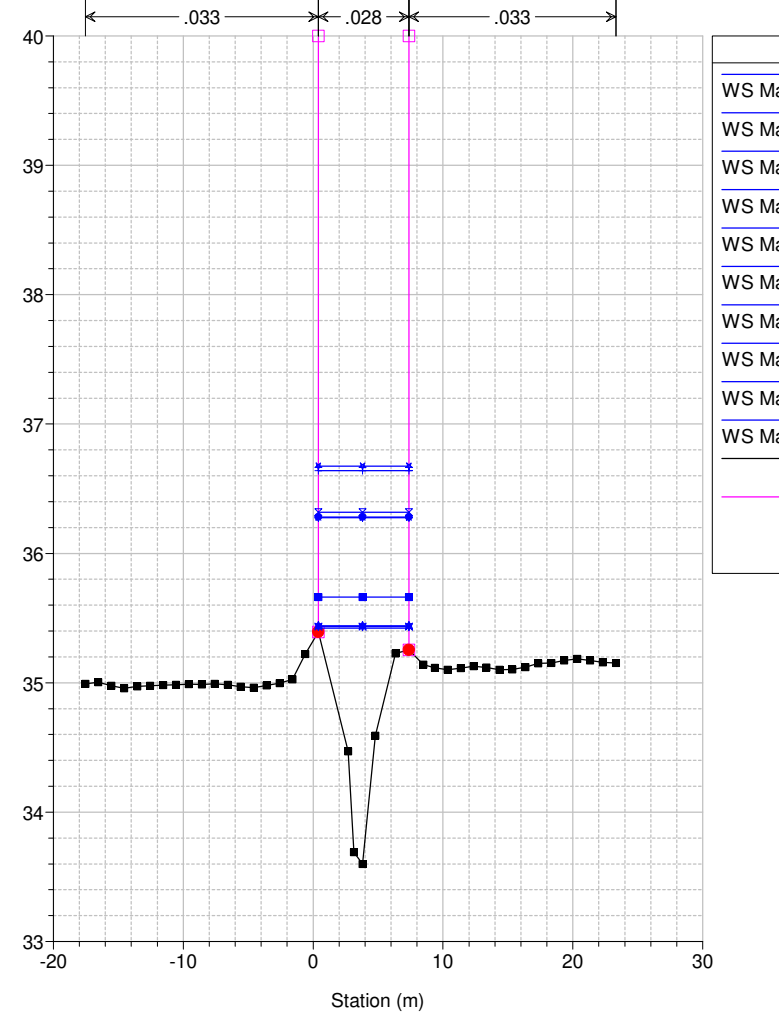

Legend	
WS Max WS - TR200_24_0	▲
WS Max WS - TR200_18_0	+
WS Max WS - TR200_12_0	✕
WS Max WS - TR200_09_0	●
WS Max WS - TR200_36_0	■
WS Max WS - TR200_06_0	▼
WS Max WS - TR200_01_5	▽
WS Max WS - TR200_01_0	▲
WS Max WS - TR200_03_0	✕
WS Max WS - TR200_00_5	■
Ground	■
Levee	□
Bank Sta	●

Studio Scandicci Torrenti Greve-Vingone
River = Fosso Rigone Reach = Rigone 03 RS = 44 RI1011_A

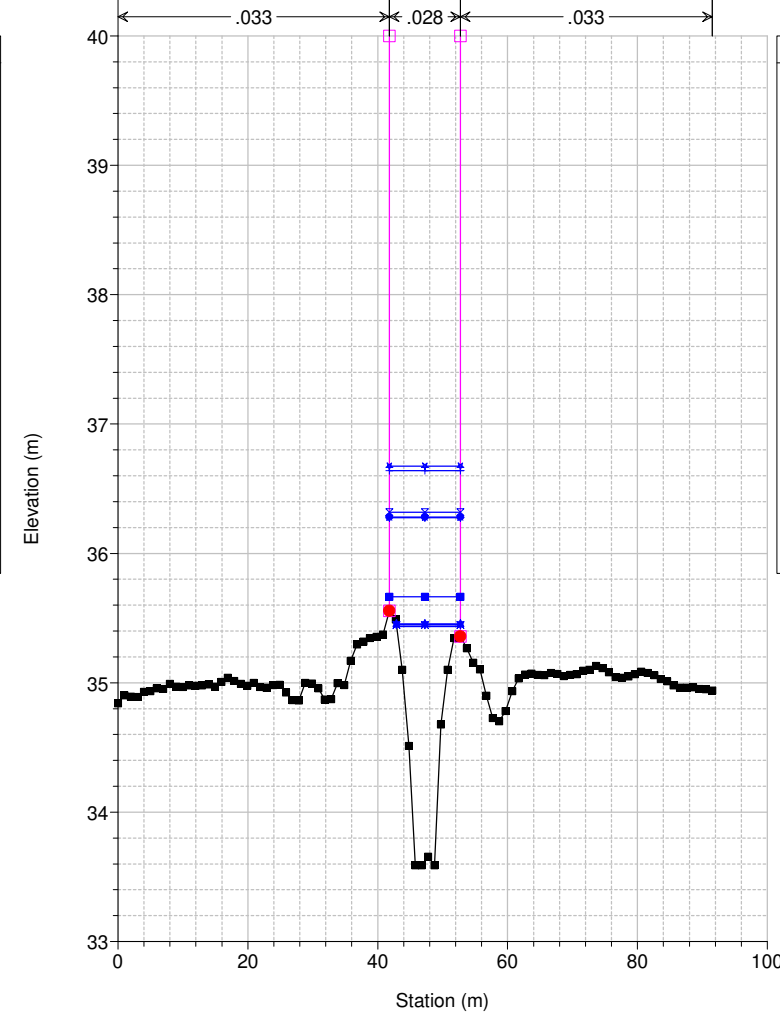

Legend	
WS Max WS - TR200_24_0	▲
WS Max WS - TR200_18_0	+
WS Max WS - TR200_12_0	✕
WS Max WS - TR200_09_0	●
WS Max WS - TR200_36_0	■
WS Max WS - TR200_06_0	▼
WS Max WS - TR200_01_5	▽
WS Max WS - TR200_01_0	▲
WS Max WS - TR200_03_0	✕
WS Max WS - TR200_00_5	■
Ground	■
Levee	□
Bank Sta	●

Studio Scandicci Torrenti Greve-Vingone
River = Fosso Rigone Reach = Rigone 03 RS = 43 RI1011_B

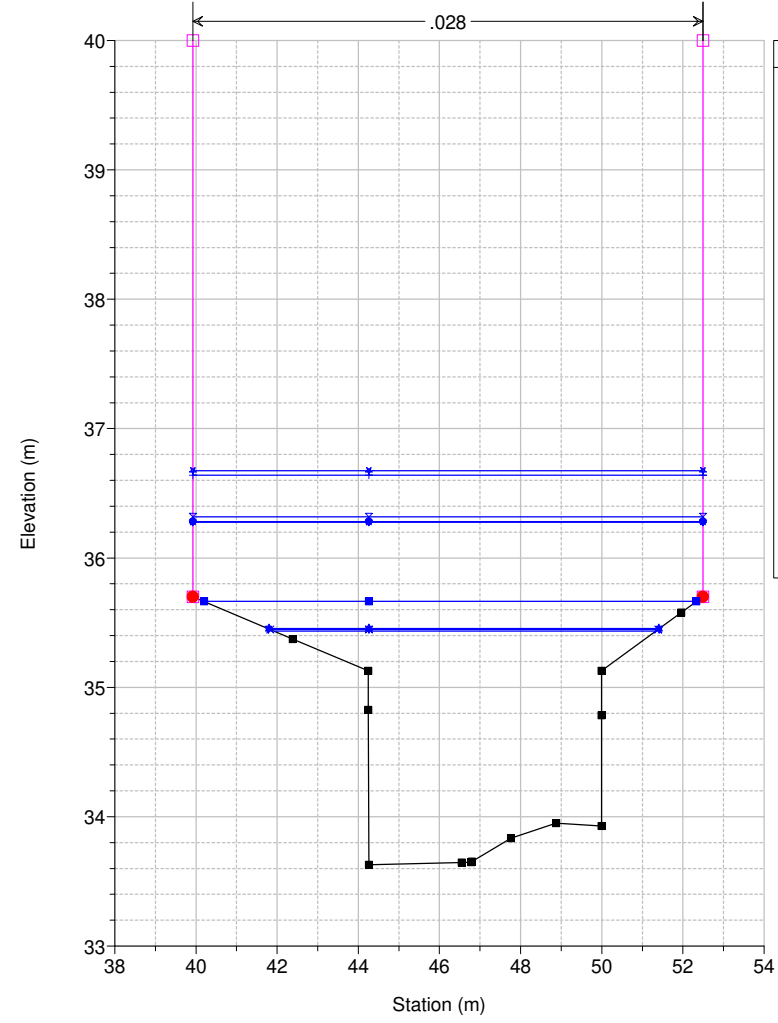

Legend

- WS Max WS - TR200_24_0
- WS Max WS - TR200_18_0
- WS Max WS - TR200_12_0
- WS Max WS - TR200_09_0
- WS Max WS - TR200_36_0
- WS Max WS - TR200_06_0
- WS Max WS - TR200_01_5
- WS Max WS - TR200_01_0
- WS Max WS - TR200_03_0
- WS Max WS - TR200_00_5
- Ground
- Levee
- Bank Sta

Studio Scandicci Torrenti Greve-Vingone
River = Fosso Rigone Reach = Rigone 03 RS = 42.5 BR

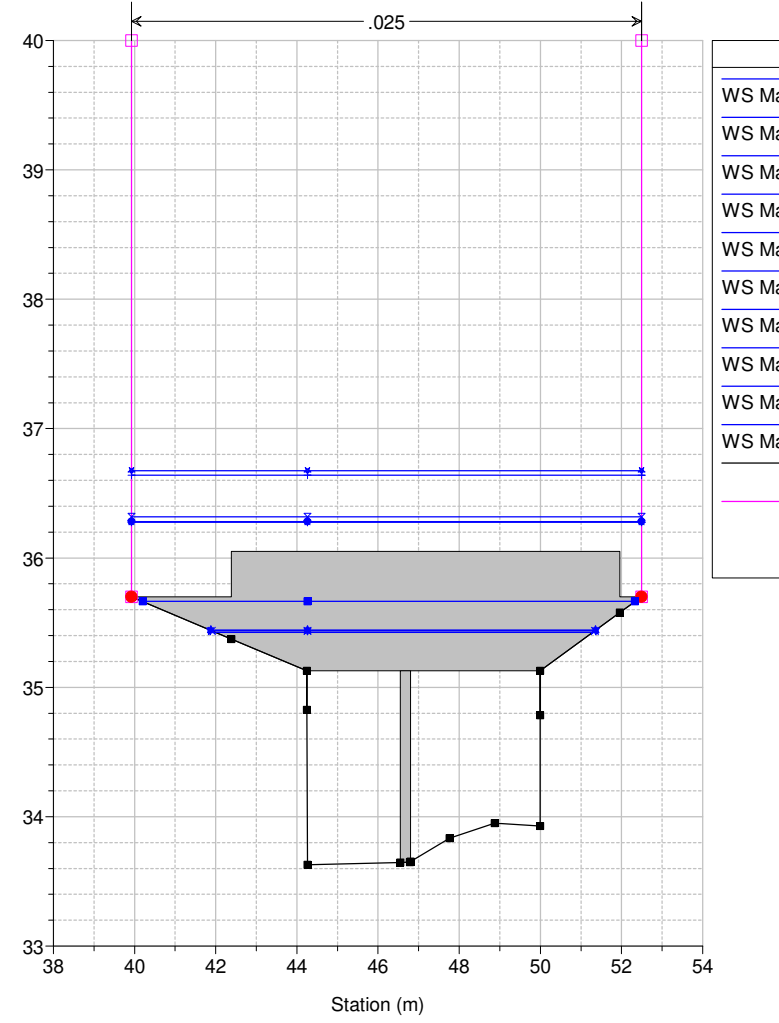

Legend

- WS Max WS - TR200_24_0
- WS Max WS - TR200_18_0
- WS Max WS - TR200_12_0
- WS Max WS - TR200_09_0
- WS Max WS - TR200_36_0
- WS Max WS - TR200_06_0
- WS Max WS - TR200_01_5
- WS Max WS - TR200_01_0
- WS Max WS - TR200_03_0
- WS Max WS - TR200_00_5
- Ground
- Levee
- Bank Sta

Studio Scandicci Torrenti Greve-Vingone
River = Fosso Rigone Reach = Rigone 03 RS = 42.5 BR

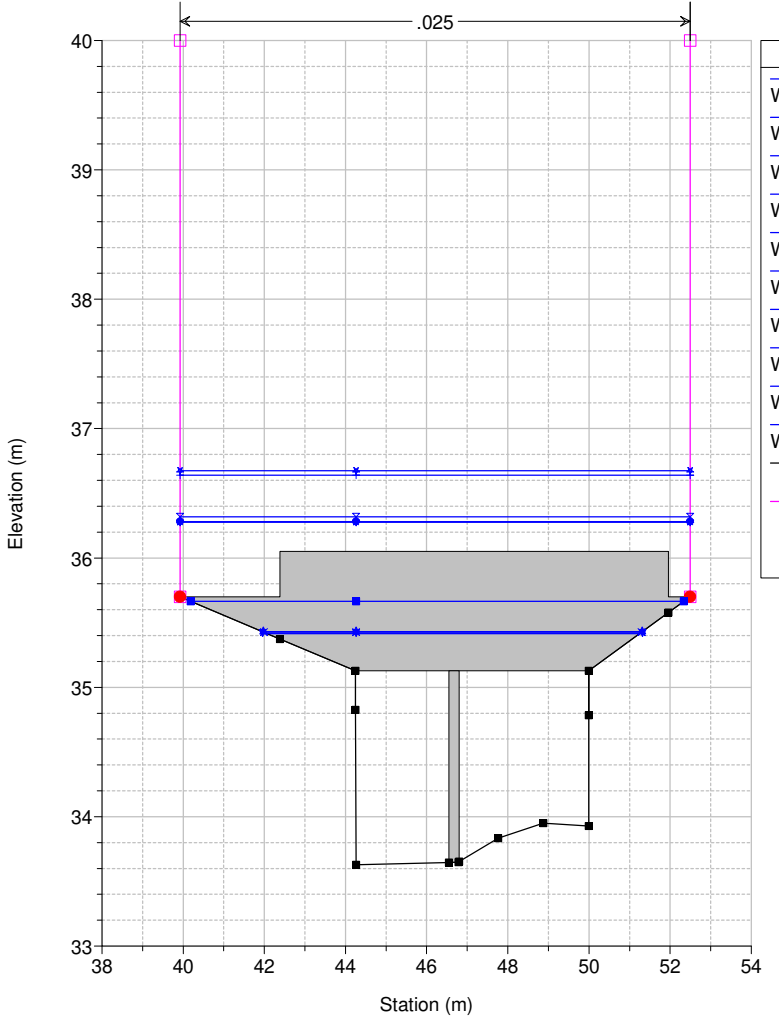

Legend

- WS Max WS - TR200_24_0
- WS Max WS - TR200_18_0
- WS Max WS - TR200_12_0
- WS Max WS - TR200_09_0
- WS Max WS - TR200_36_0
- WS Max WS - TR200_06_0
- WS Max WS - TR200_01_5
- WS Max WS - TR200_01_0
- WS Max WS - TR200_03_0
- WS Max WS - TR200_00_5
- Ground
- Levee
- Bank Sta

Studio Scandicci Torrenti Greve-Vingone
River = Fosso Rigone Reach = Rigone 03 RS = 42 RI1011_C

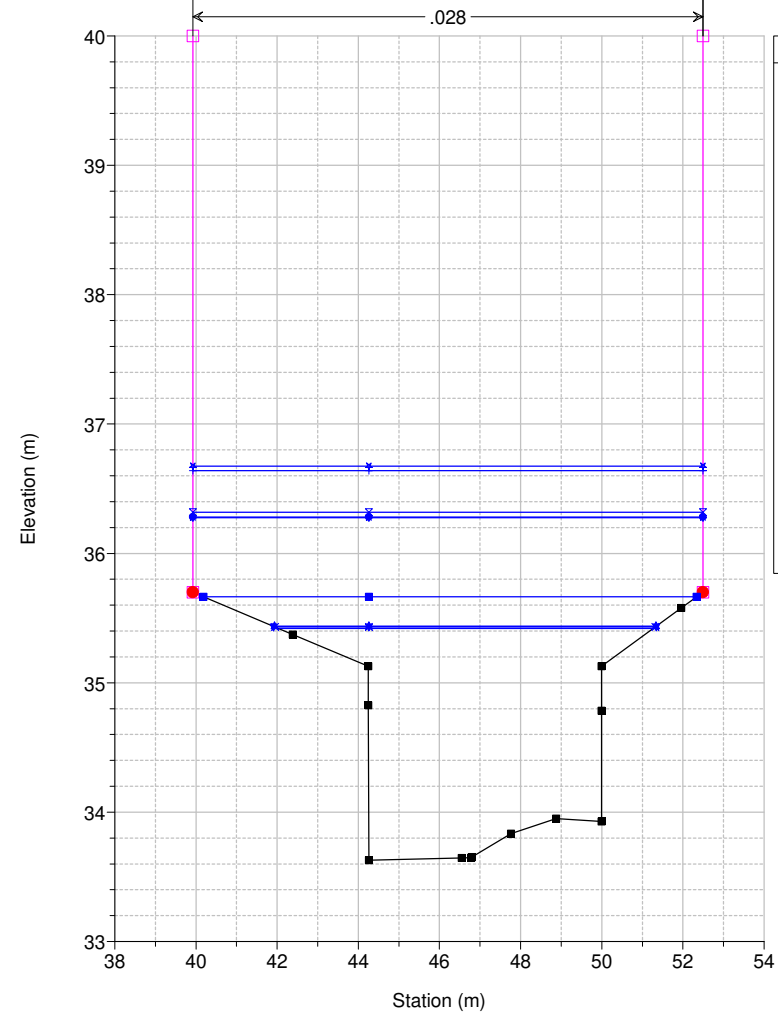

Legend

- WS Max WS - TR200_24_0
- WS Max WS - TR200_18_0
- WS Max WS - TR200_12_0
- WS Max WS - TR200_09_0
- WS Max WS - TR200_36_0
- WS Max WS - TR200_06_0
- WS Max WS - TR200_01_5
- WS Max WS - TR200_01_0
- WS Max WS - TR200_03_0
- WS Max WS - TR200_00_5
- Ground
- Levee
- Bank Sta

Studio Scandicci Torrenti Greve-Vingone
River = Fosso Rigone Reach = Rigone 03 RS = 41 RI1011_D

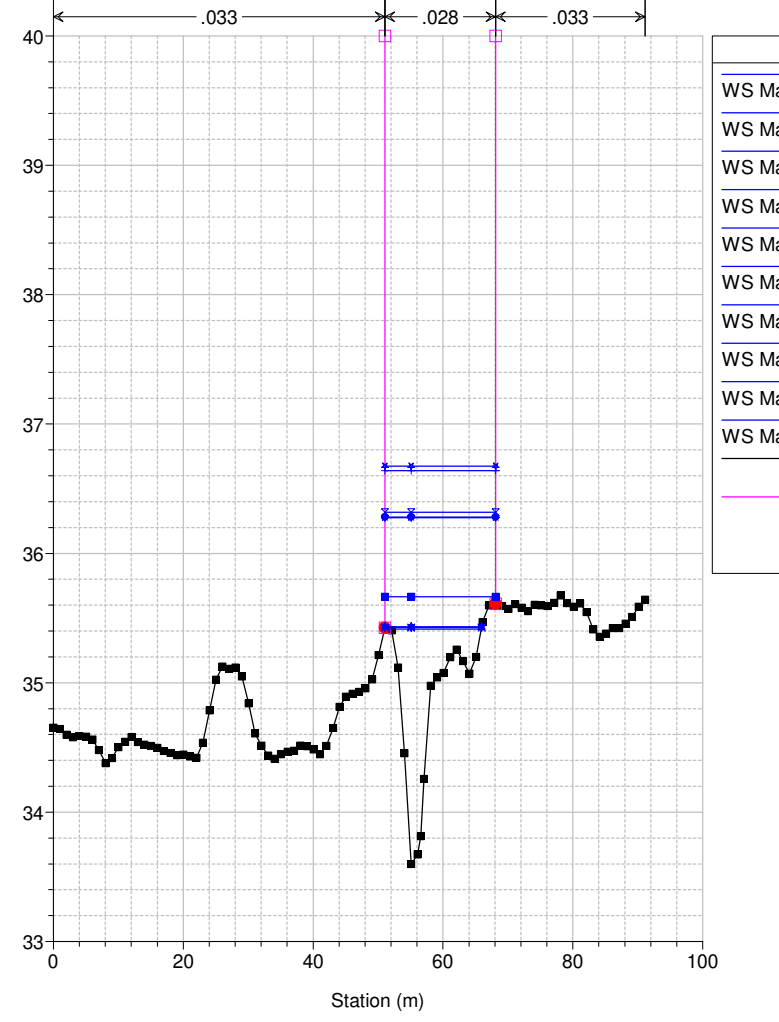

Legend

- WS Max WS - TR200_24_0
- WS Max WS - TR200_18_0
- WS Max WS - TR200_12_0
- WS Max WS - TR200_09_0
- WS Max WS - TR200_36_0
- WS Max WS - TR200_06_0
- WS Max WS - TR200_01_5
- WS Max WS - TR200_01_0
- WS Max WS - TR200_03_0
- WS Max WS - TR200_00_5
- Ground
- Levee
- Bank Sta

Studio Scandicci Torrenti Greve-Vingone
River = Fosso Rigone Reach = Rigone 03 RS = 40 RI1012_

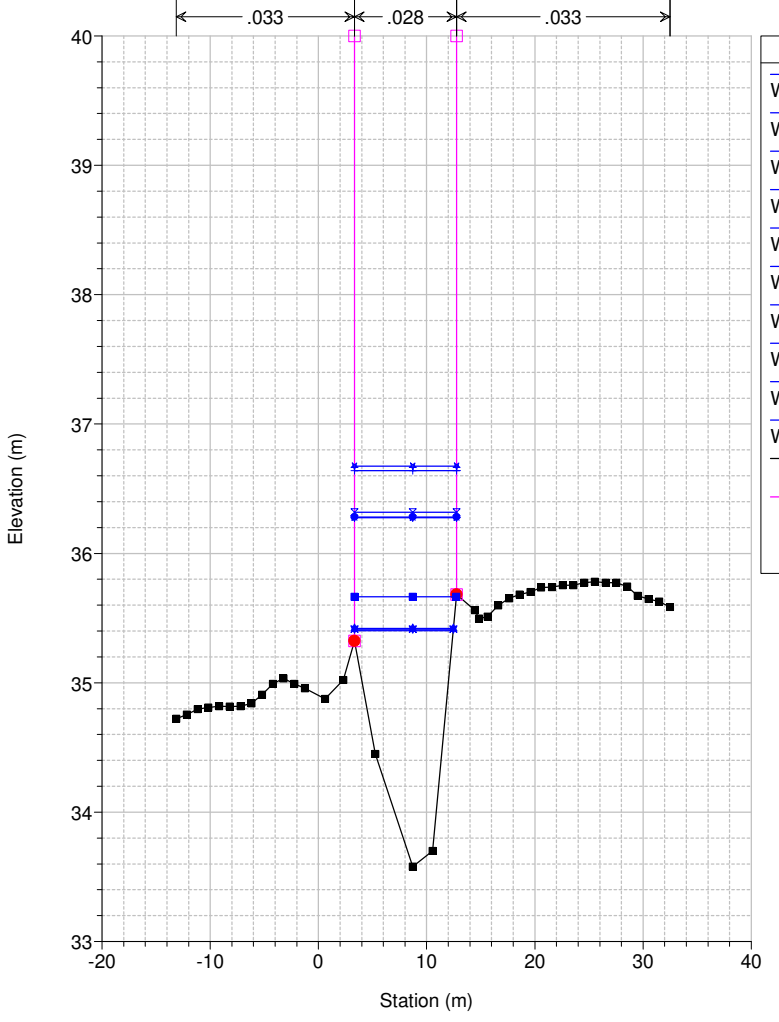

Legend

- WS Max WS - TR200_24_0
- WS Max WS - TR200_18_0
- WS Max WS - TR200_12_0
- WS Max WS - TR200_09_0
- WS Max WS - TR200_36_0
- WS Max WS - TR200_06_0
- WS Max WS - TR200_01_5
- WS Max WS - TR200_01_0
- WS Max WS - TR200_03_0
- WS Max WS - TR200_00_5
- Ground
- Levee
- Bank Sta

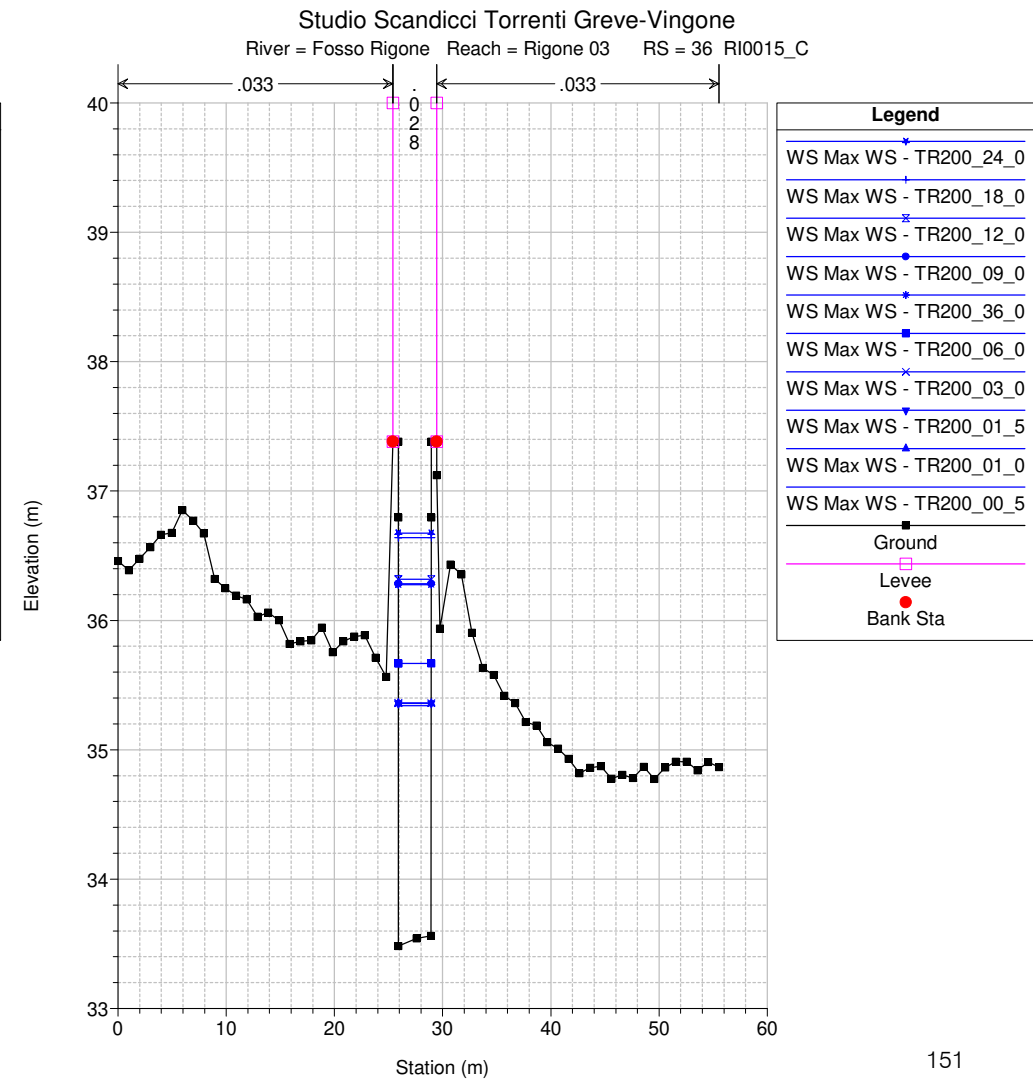
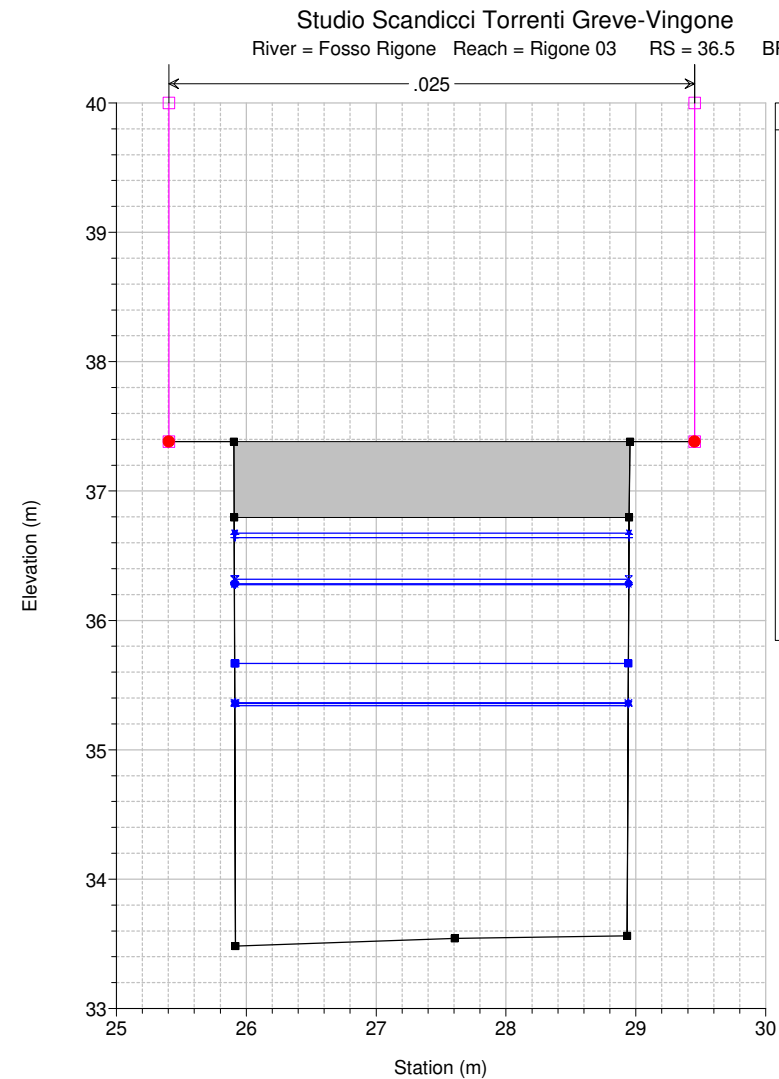
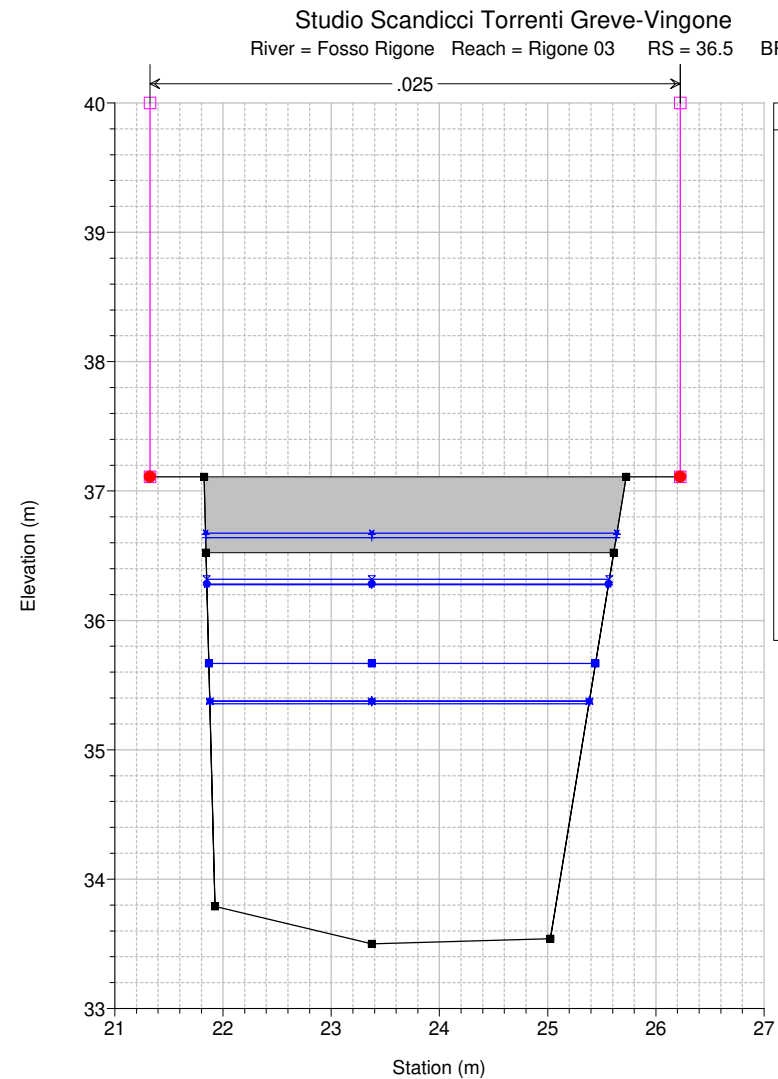
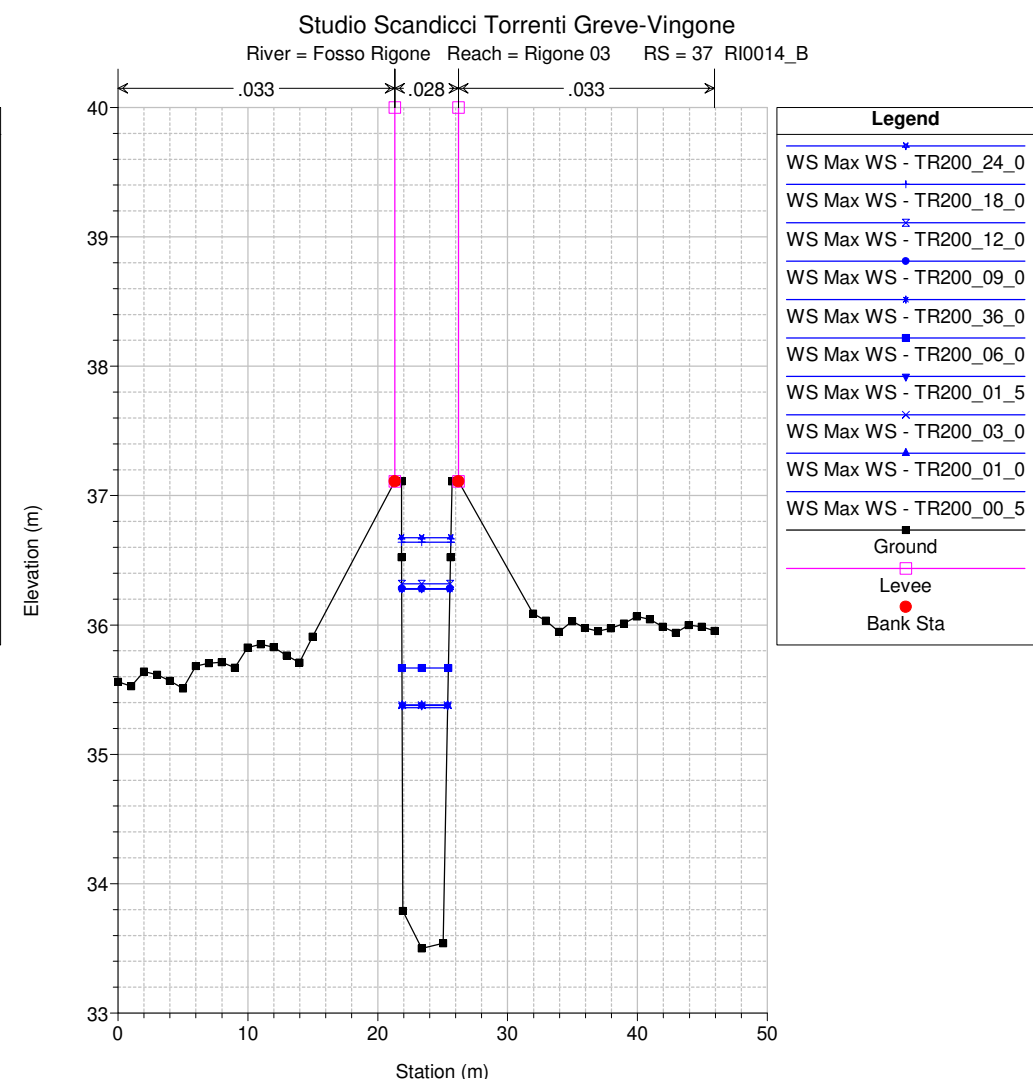
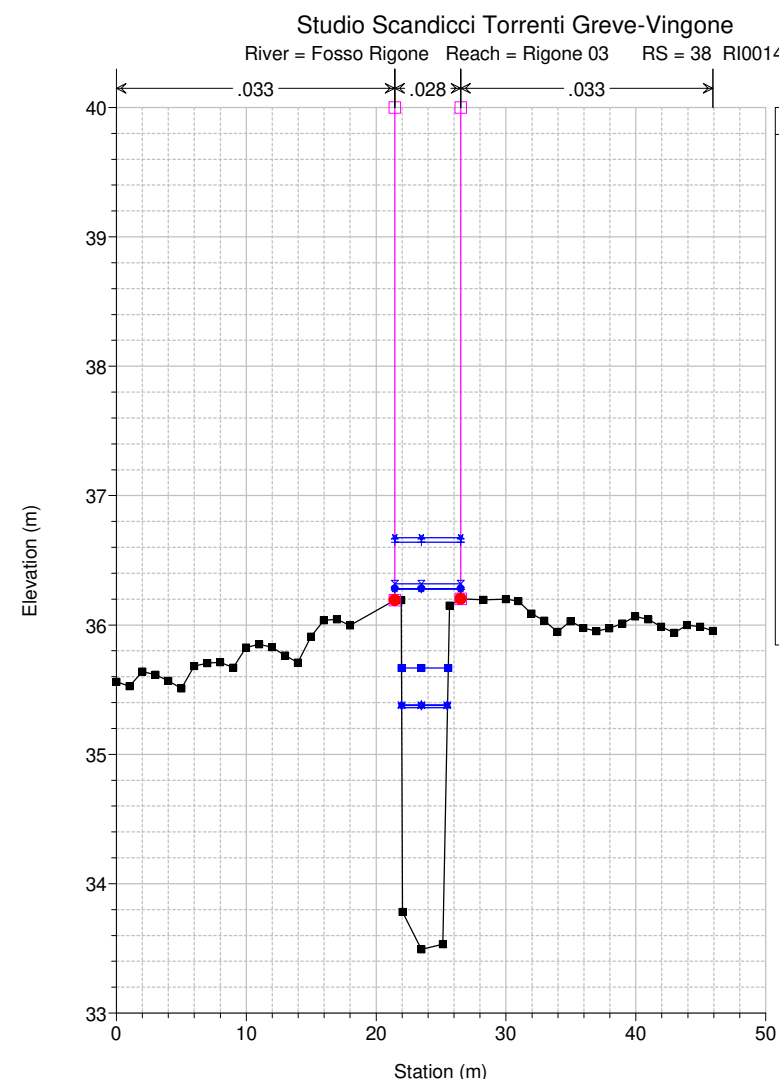
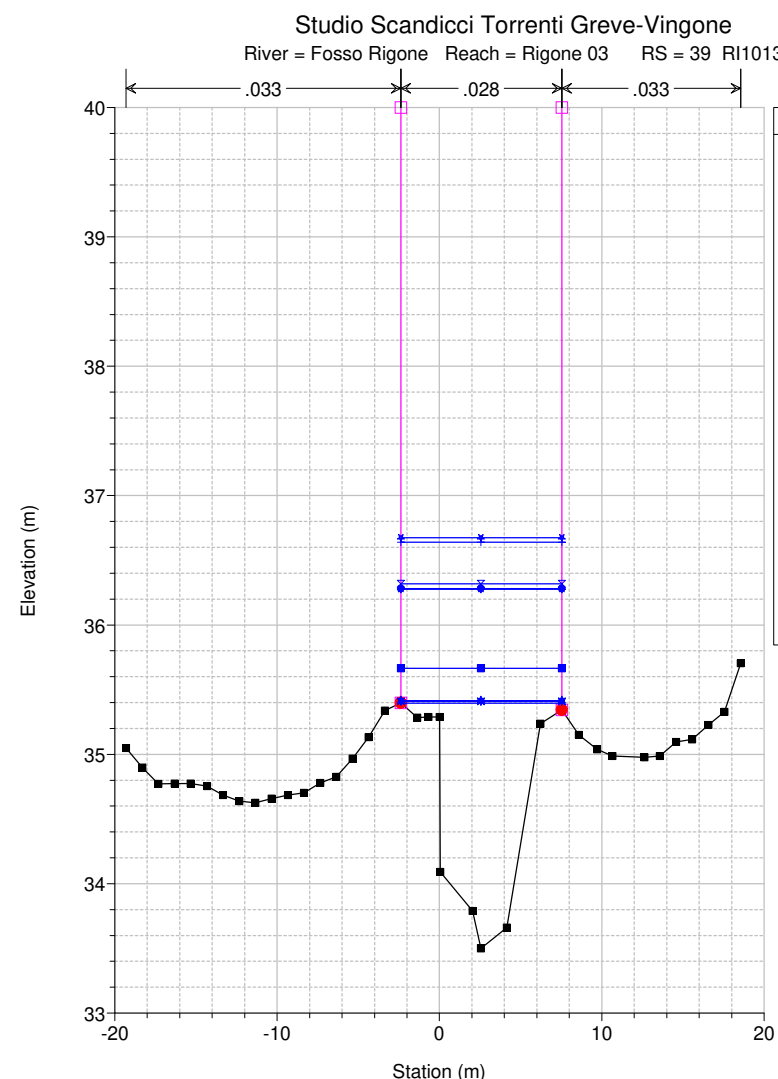

Studio Scandicci Torrenti Greve-Vingone
River = Fosso Rigone Reach = Rigone 03 RS = 35 RI0015_D

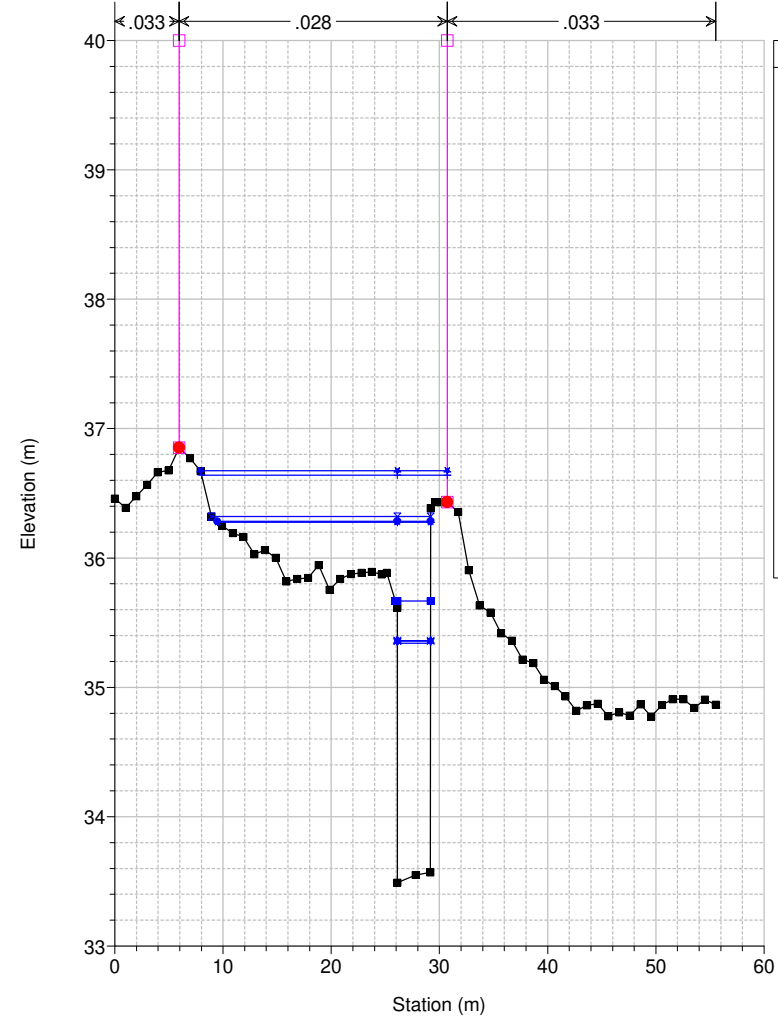

Legend

- WS Max WS - TR200_24_0
- WS Max WS - TR200_18_0
- WS Max WS - TR200_12_0
- WS Max WS - TR200_09_0
- WS Max WS - TR200_36_0
- WS Max WS - TR200_06_0
- WS Max WS - TR200_03_0
- WS Max WS - TR200_01_5
- WS Max WS - TR200_01_0
- WS Max WS - TR200_00_5
- Ground
- Levee
- Bank Sta

Studio Scandicci Torrenti Greve-Vingone
River = Fosso Rigone Reach = Rigone 03 RS = 34 RI0016_A

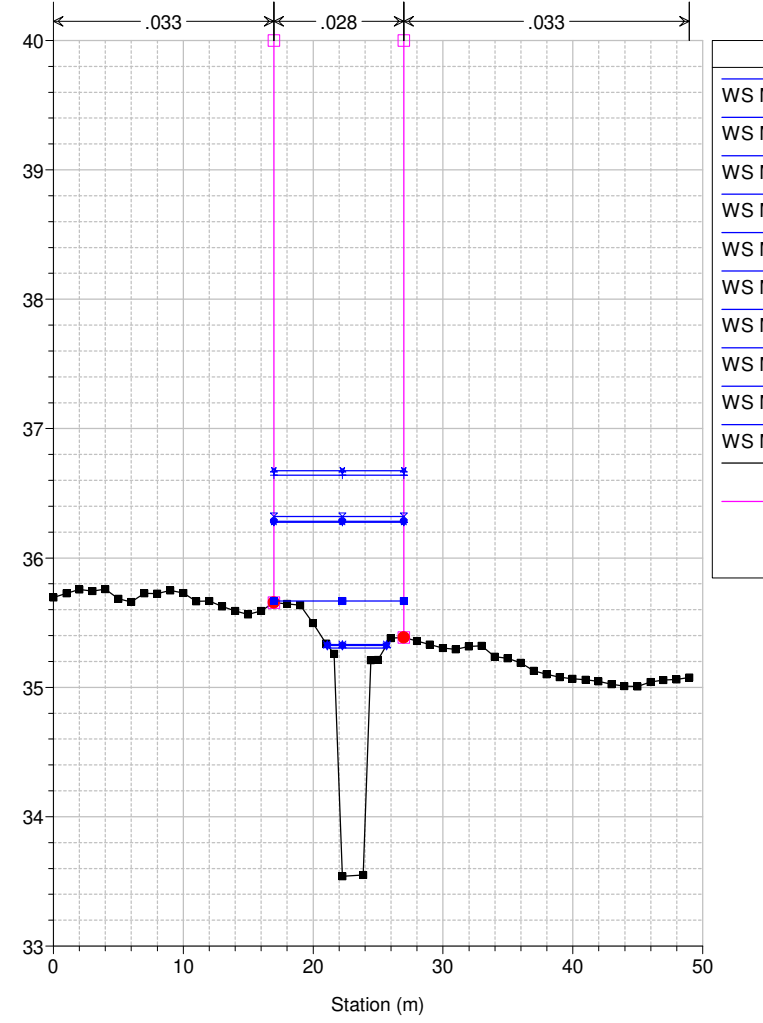

Legend

- WS Max WS - TR200_24_0
- WS Max WS - TR200_18_0
- WS Max WS - TR200_12_0
- WS Max WS - TR200_09_0
- WS Max WS - TR200_36_0
- WS Max WS - TR200_06_0
- WS Max WS - TR200_03_0
- WS Max WS - TR200_01_5
- WS Max WS - TR200_01_0
- WS Max WS - TR200_00_5
- Ground
- Levee
- Bank Sta

Studio Scandicci Torrenti Greve-Vingone
River = Fosso Rigone Reach = Rigone 03 RS = 33 RI0016_B

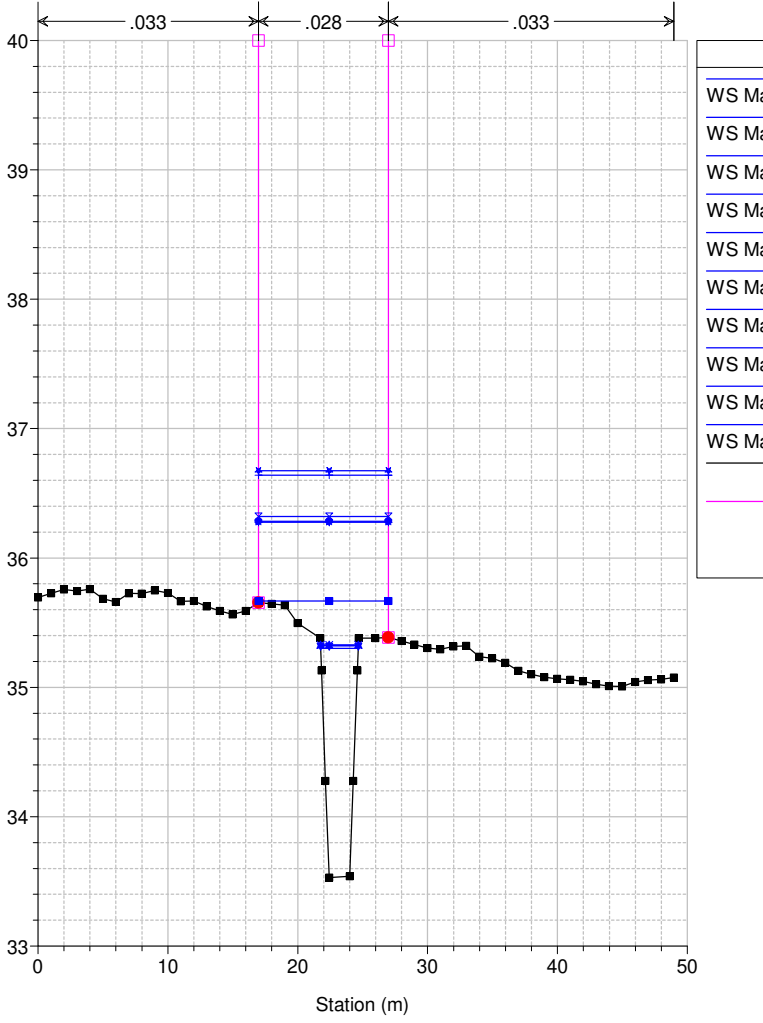

Legend

- WS Max WS - TR200_24_0
- WS Max WS - TR200_18_0
- WS Max WS - TR200_12_0
- WS Max WS - TR200_09_0
- WS Max WS - TR200_36_0
- WS Max WS - TR200_06_0
- WS Max WS - TR200_03_0
- WS Max WS - TR200_01_5
- WS Max WS - TR200_01_0
- WS Max WS - TR200_00_5
- Ground
- Levee
- Bank Sta

Studio Scandicci Torrenti Greve-Vingone
River = Fosso Rigone Reach = Rigone 03 RS = 32.5 BR

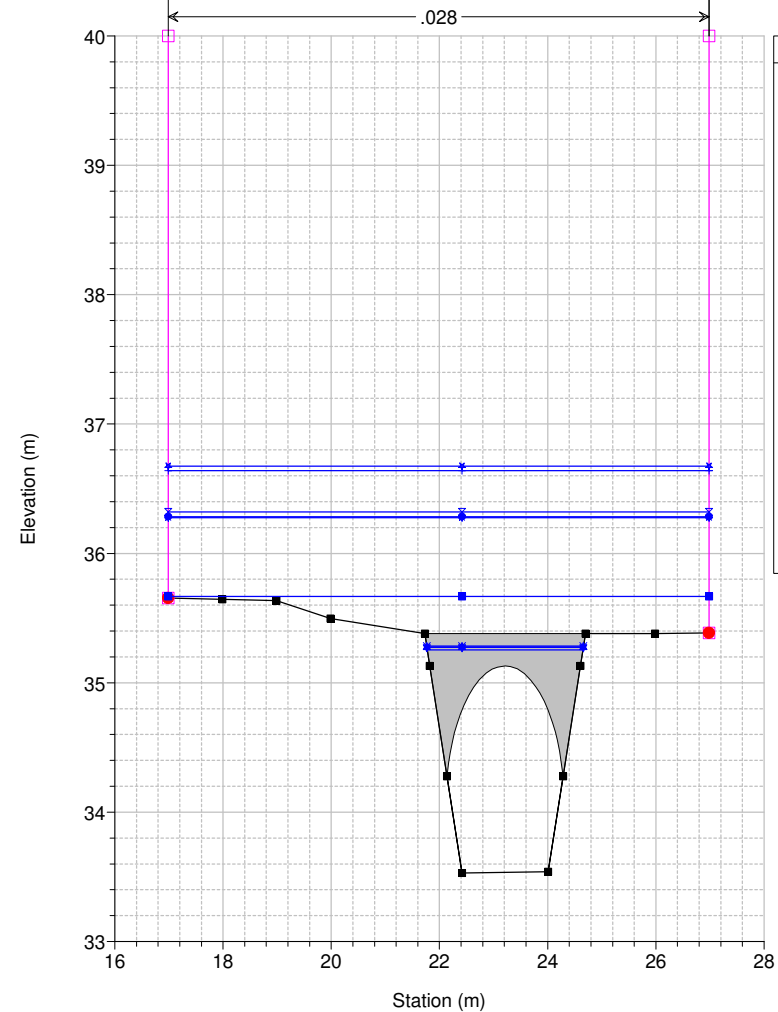

Legend

- WS Max WS - TR200_24_0
- WS Max WS - TR200_18_0
- WS Max WS - TR200_12_0
- WS Max WS - TR200_09_0
- WS Max WS - TR200_36_0
- WS Max WS - TR200_06_0
- WS Max WS - TR200_03_0
- WS Max WS - TR200_01_5
- WS Max WS - TR200_01_0
- WS Max WS - TR200_00_5
- Ground
- Levee
- Bank Sta

Studio Scandicci Torrenti Greve-Vingone
River = Fosso Rigone Reach = Rigone 03 RS = 32.5 BR

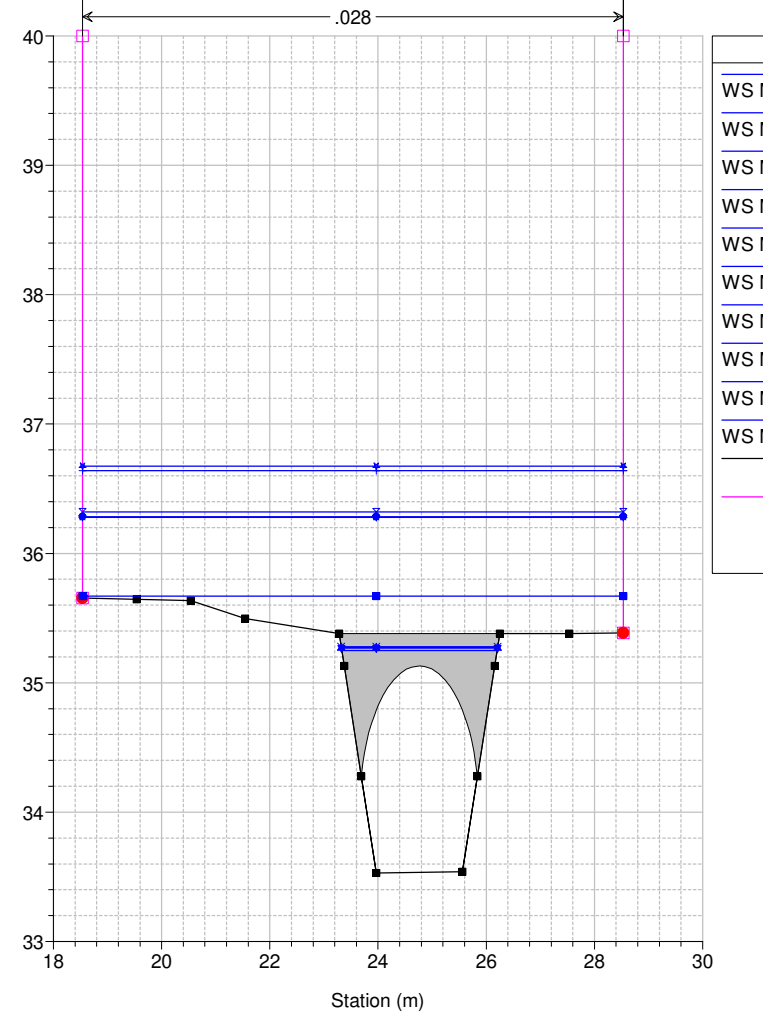

Legend

- WS Max WS - TR200_24_0
- WS Max WS - TR200_18_0
- WS Max WS - TR200_12_0
- WS Max WS - TR200_09_0
- WS Max WS - TR200_36_0
- WS Max WS - TR200_06_0
- WS Max WS - TR200_03_0
- WS Max WS - TR200_01_5
- WS Max WS - TR200_01_0
- WS Max WS - TR200_00_5
- Ground
- Levee
- Bank Sta

Studio Scandicci Torrenti Greve-Vingone
River = Fosso Rigone Reach = Rigone 03 RS = 32 RI0016_C

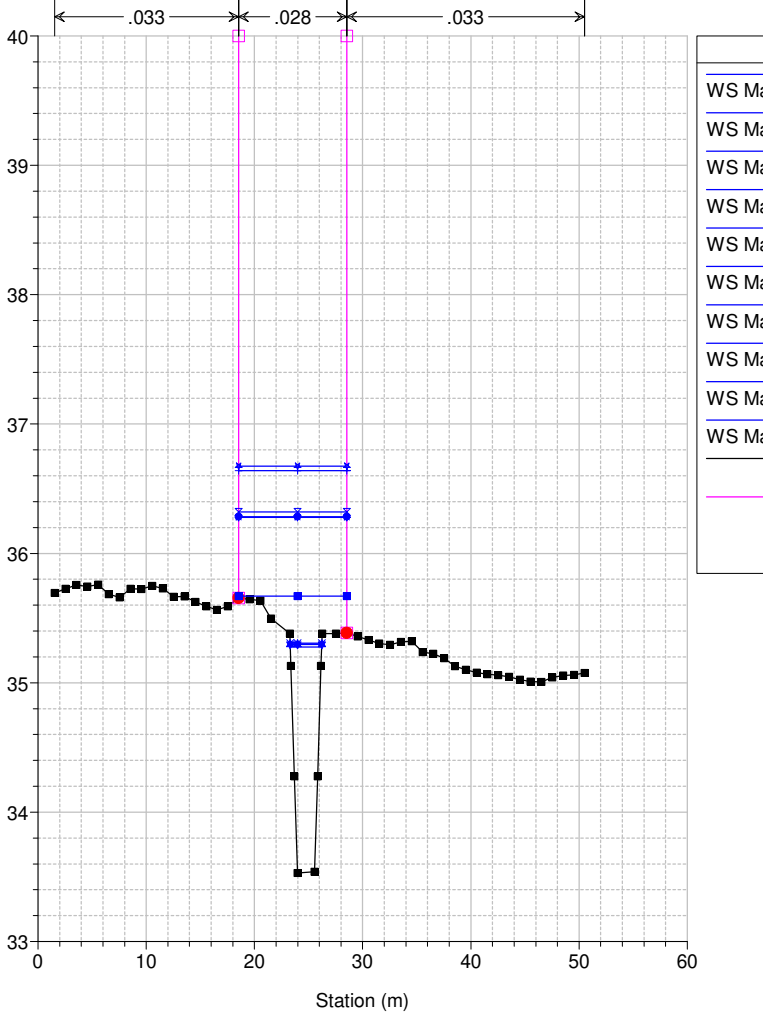

Legend

- WS Max WS - TR200_24_0
- WS Max WS - TR200_18_0
- WS Max WS - TR200_12_0
- WS Max WS - TR200_09_0
- WS Max WS - TR200_36_0
- WS Max WS - TR200_06_0
- WS Max WS - TR200_03_0
- WS Max WS - TR200_01_5
- WS Max WS - TR200_01_0
- WS Max WS - TR200_00_5
- Ground
- Levee
- Bank Sta

Studio Scandicci Torrenti Greve-Vingone
River = Fosso Rigone Reach = Rigone 03 RS = 31 RI0016_D

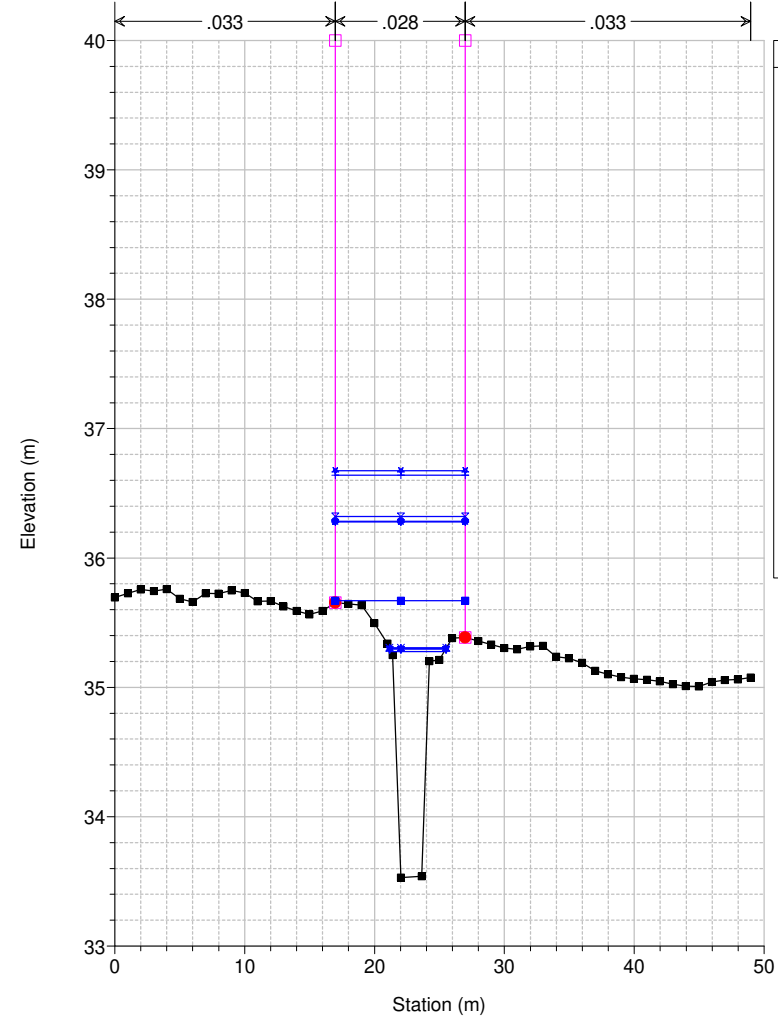

Legend	
WS Max WS - TR200_24_0	▲
WS Max WS - TR200_18_0	▲
WS Max WS - TR200_12_0	▲
WS Max WS - TR200_09_0	▲
WS Max WS - TR200_36_0	▲
WS Max WS - TR200_06_0	▲
WS Max WS - TR200_03_0	▲
WS Max WS - TR200_01_5	▲
WS Max WS - TR200_01_0	▲
WS Max WS - TR200_00_5	▲
Ground	■
Levee	□
Bank Sta	●

Studio Scandicci Torrenti Greve-Vingone
River = Fosso Rigone Reach = Rigone 03 RS = 30 RI1016_A

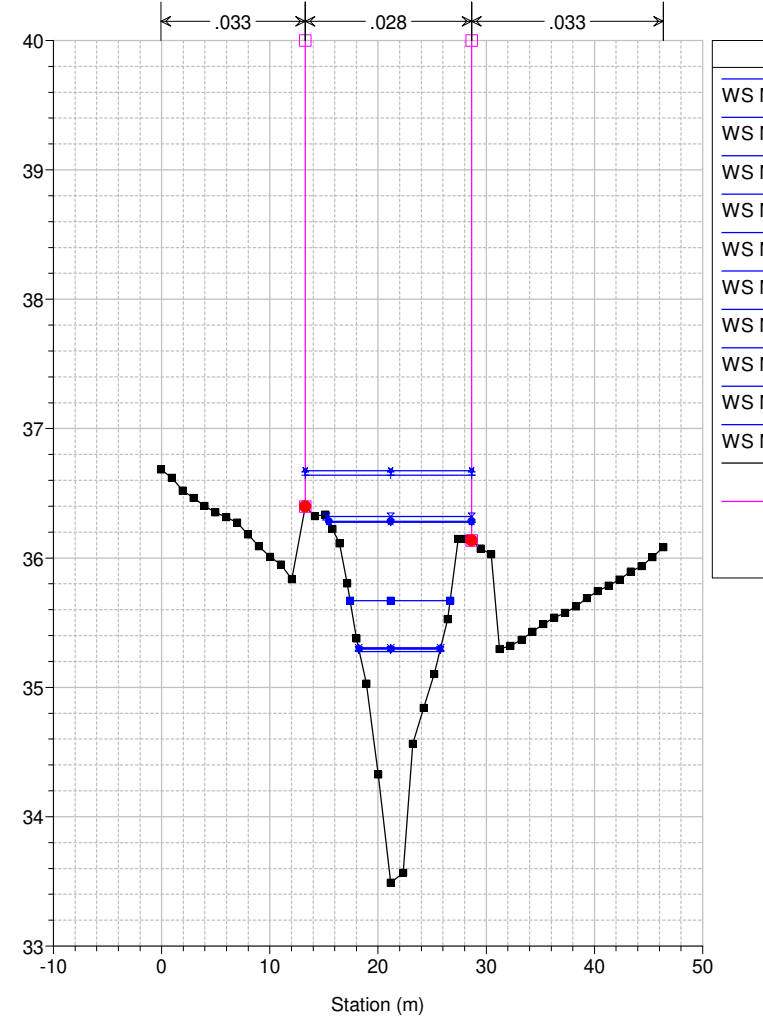

Legend	
WS Max WS - TR200_24_0	▲
WS Max WS - TR200_18_0	▲
WS Max WS - TR200_12_0	▲
WS Max WS - TR200_09_0	▲
WS Max WS - TR200_36_0	▲
WS Max WS - TR200_06_0	▲
WS Max WS - TR200_03_0	▲
WS Max WS - TR200_01_5	▲
WS Max WS - TR200_01_0	▲
WS Max WS - TR200_00_5	▲
Ground	■
Levee	□
Bank Sta	●

Studio Scandicci Torrenti Greve-Vingone
River = Fosso Rigone Reach = Rigone 03 RS = 29 RI1016_B

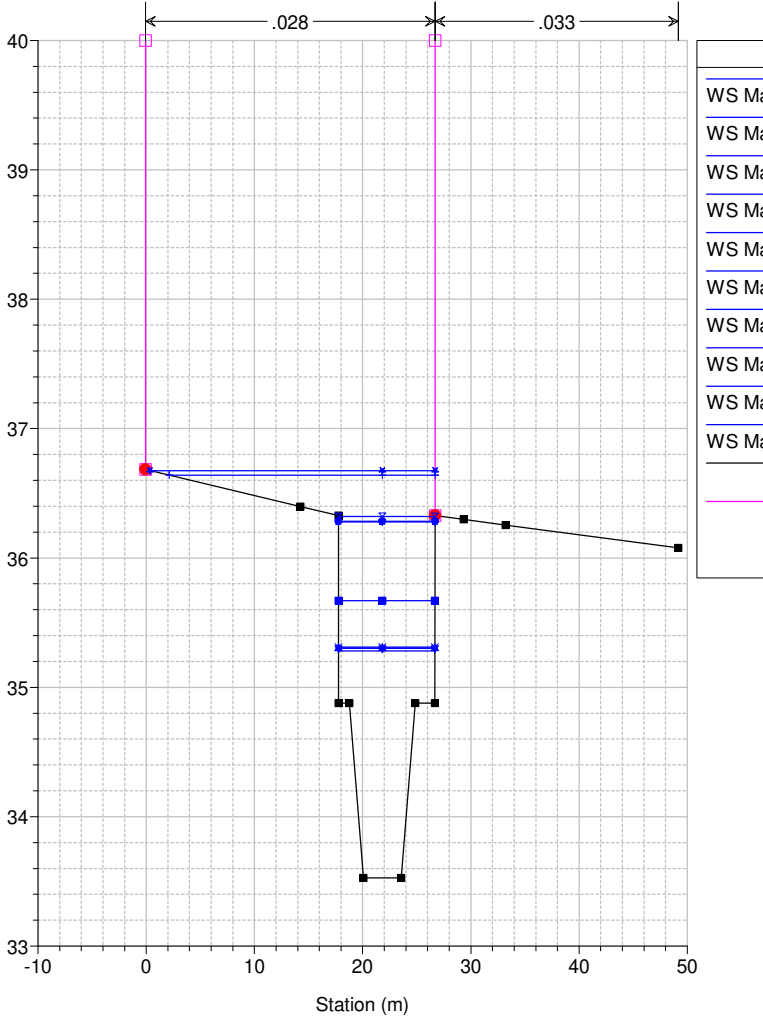

Legend	
WS Max WS - TR200_24_0	▲
WS Max WS - TR200_18_0	▲
WS Max WS - TR200_12_0	▲
WS Max WS - TR200_09_0	▲
WS Max WS - TR200_36_0	▲
WS Max WS - TR200_06_0	▲
WS Max WS - TR200_03_0	▲
WS Max WS - TR200_01_5	▲
WS Max WS - TR200_01_0	▲
WS Max WS - TR200_00_5	▲
Ground	■
Levee	□
Bank Sta	●

Studio Scandicci Torrenti Greve-Vingone
River = Fosso Rigone Reach = Rigone 03 RS = 28.5 BR

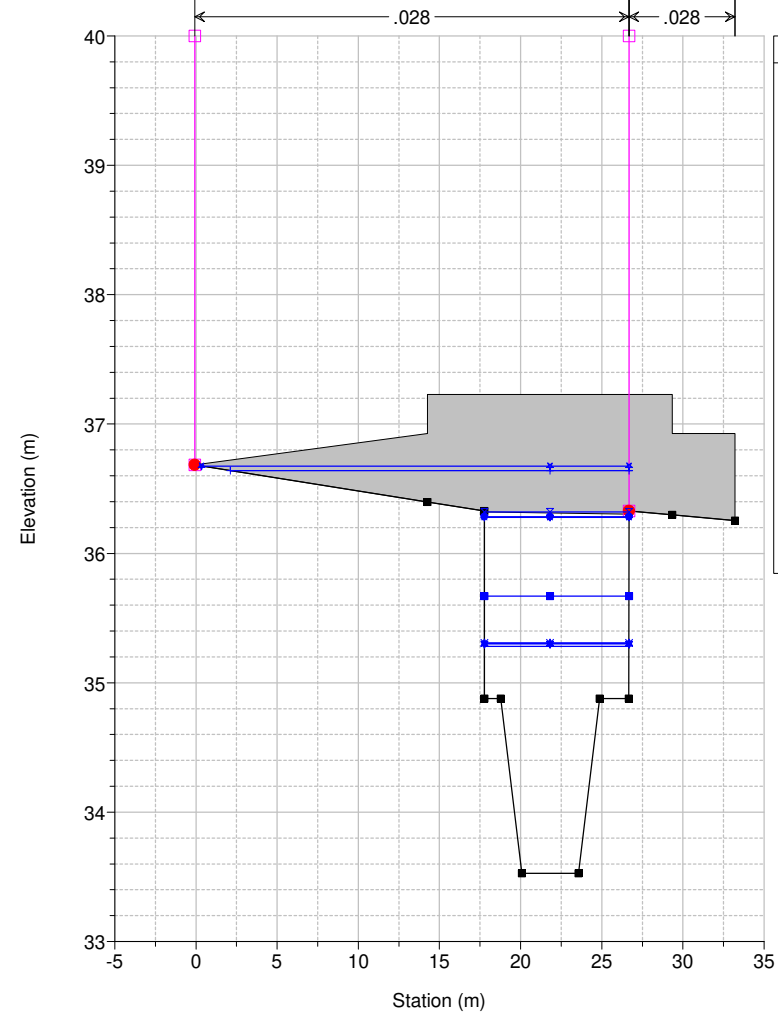

Legend	
WS Max WS - TR200_24_0	▲
WS Max WS - TR200_18_0	▲
WS Max WS - TR200_12_0	▲
WS Max WS - TR200_09_0	▲
WS Max WS - TR200_36_0	▲
WS Max WS - TR200_06_0	▲
WS Max WS - TR200_03_0	▲
WS Max WS - TR200_01_5	▲
WS Max WS - TR200_01_0	▲
WS Max WS - TR200_00_5	▲
Ground	■
Levee	□
Bank Sta	●

Studio Scandicci Torrenti Greve-Vingone
River = Fosso Rigone Reach = Rigone 03 RS = 28.5 BR

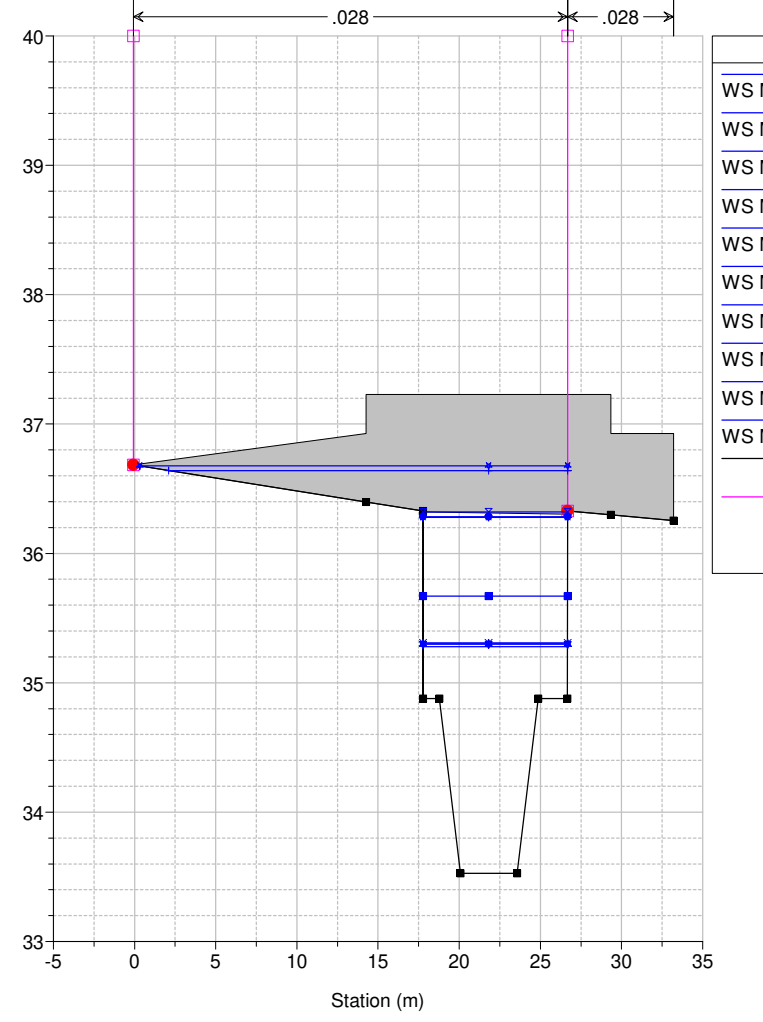

Legend	
WS Max WS - TR200_24_0	▲
WS Max WS - TR200_18_0	▲
WS Max WS - TR200_12_0	▲
WS Max WS - TR200_09_0	▲
WS Max WS - TR200_36_0	▲
WS Max WS - TR200_06_0	▲
WS Max WS - TR200_03_0	▲
WS Max WS - TR200_01_5	▲
WS Max WS - TR200_01_0	▲
WS Max WS - TR200_00_5	▲
Ground	■
Levee	□
Bank Sta	●

Studio Scandicci Torrenti Greve-Vingone
River = Fosso Rigone Reach = Rigone 03 RS = 28 RI1016_C

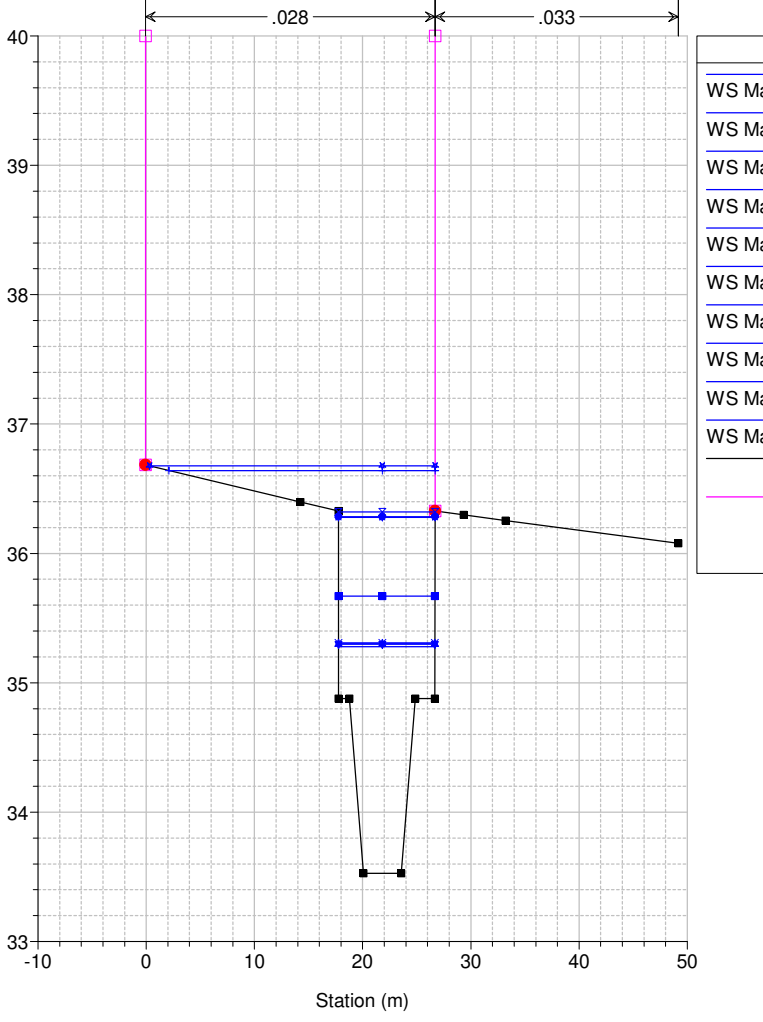

Legend	
WS Max WS - TR200_24_0	▲
WS Max WS - TR200_18_0	▲
WS Max WS - TR200_12_0	▲
WS Max WS - TR200_09_0	▲
WS Max WS - TR200_36_0	▲
WS Max WS - TR200_06_0	▲
WS Max WS - TR200_03_0	▲
WS Max WS - TR200_01_5	▲
WS Max WS - TR200_01_0	▲
WS Max WS - TR200_00_5	▲
Ground	■
Levee	□
Bank Sta	●

Studio Scandicci Torrenti Greve-Vingone
River = Fosso Rigone Reach = Rigone 03 RS = 27 RI1016_D

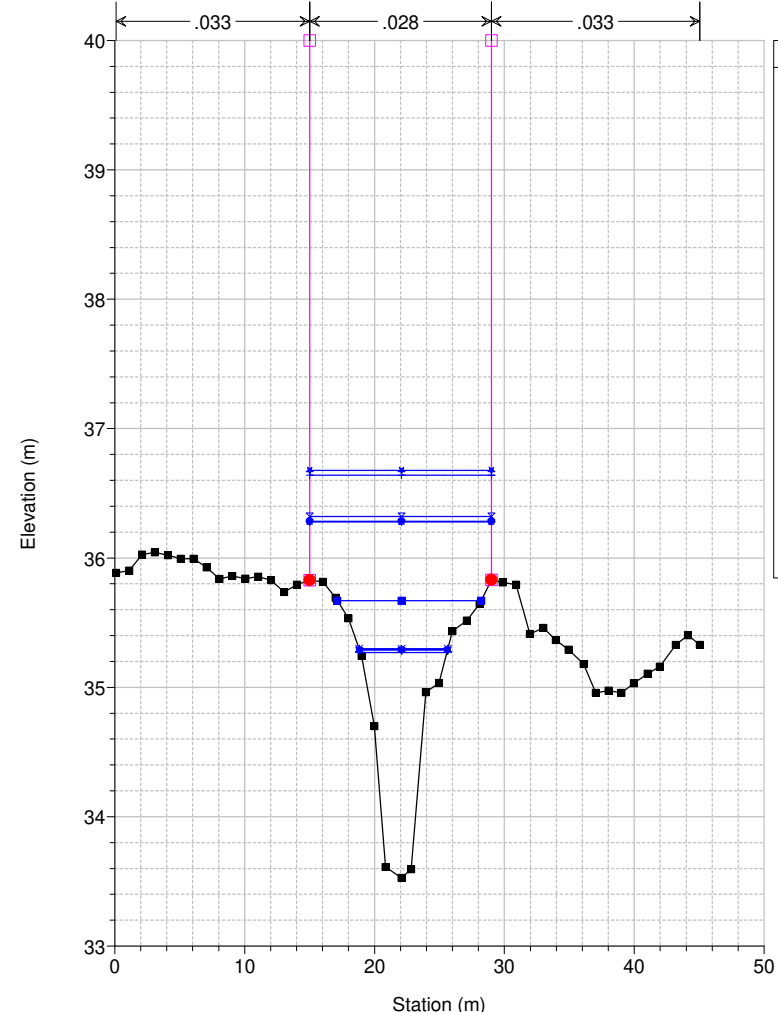

Studio Scandicci Torrenti Greve-Vingone
River = Fosso Rigone Reach = Rigone 03 RS = 26 RI0017_

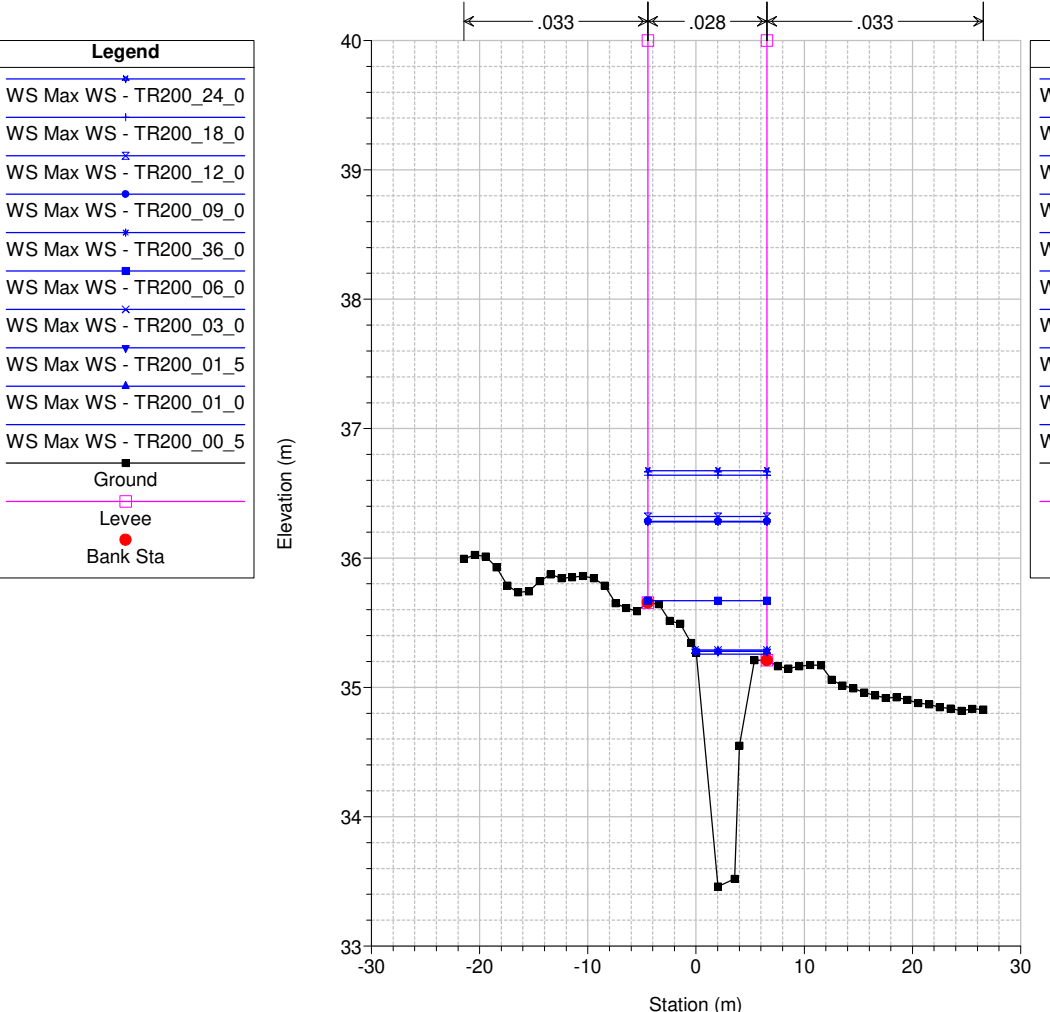

Studio Scandicci Torrenti Greve-Vingone
River = Fosso Rigone Reach = Rigone 03 RS = 25.4

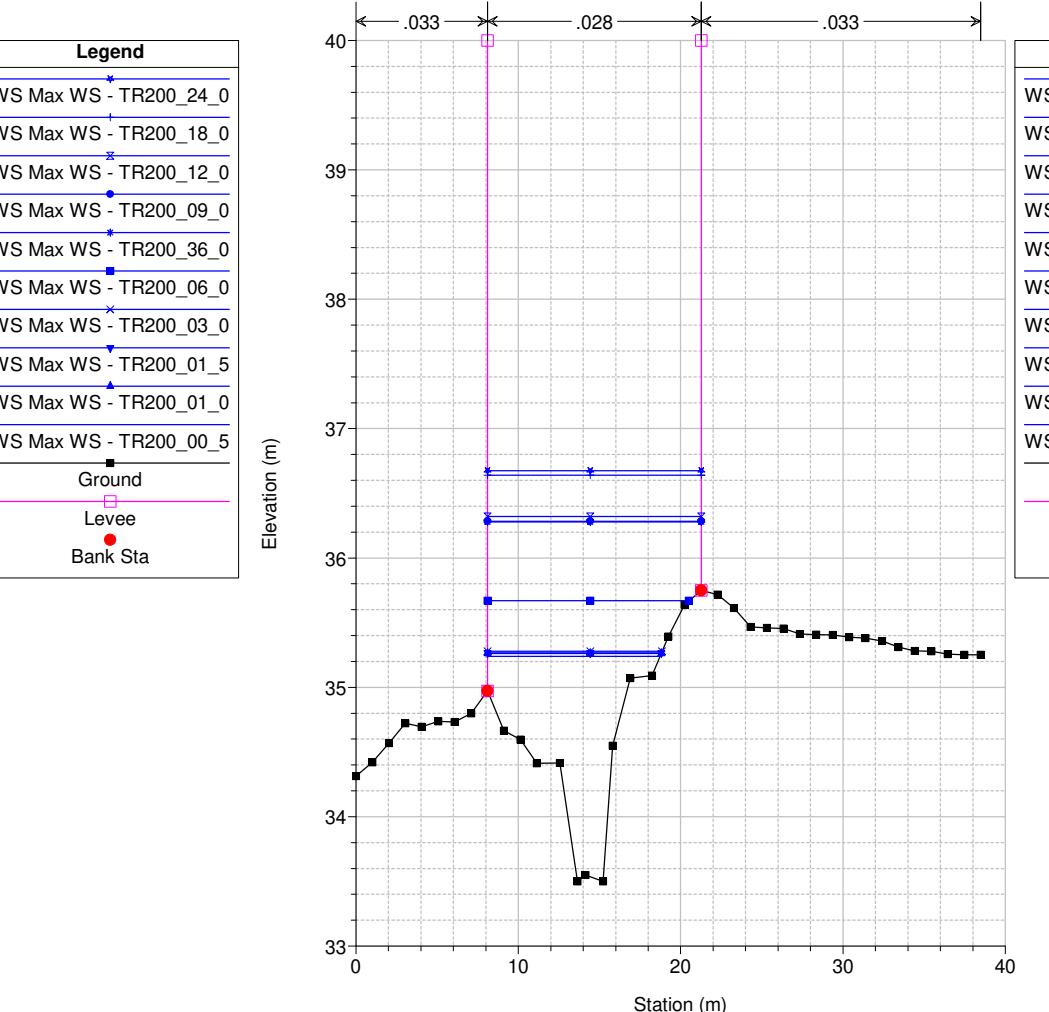

Studio Scandicci Torrenti Greve-Vingone
River = Fosso Rigone Reach = Rigone 02 RS = 25 RI0018_A

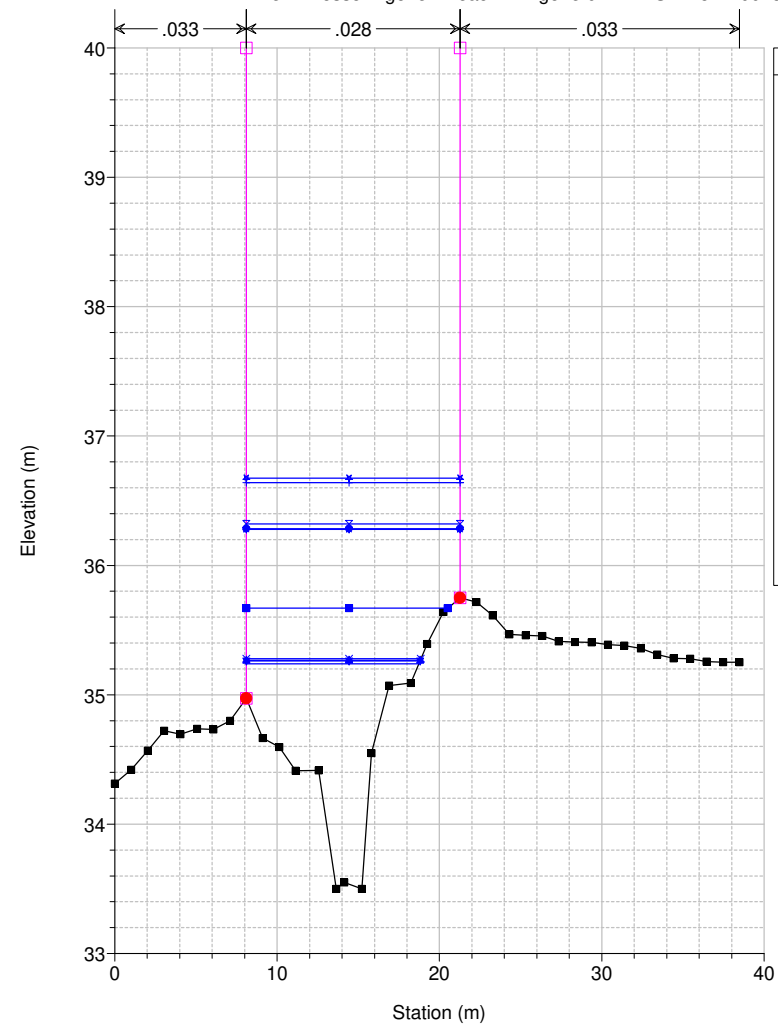

Studio Scandicci Torrenti Greve-Vingone
River = Fosso Rigone Reach = Rigone 02 RS = 24 RI0018_B

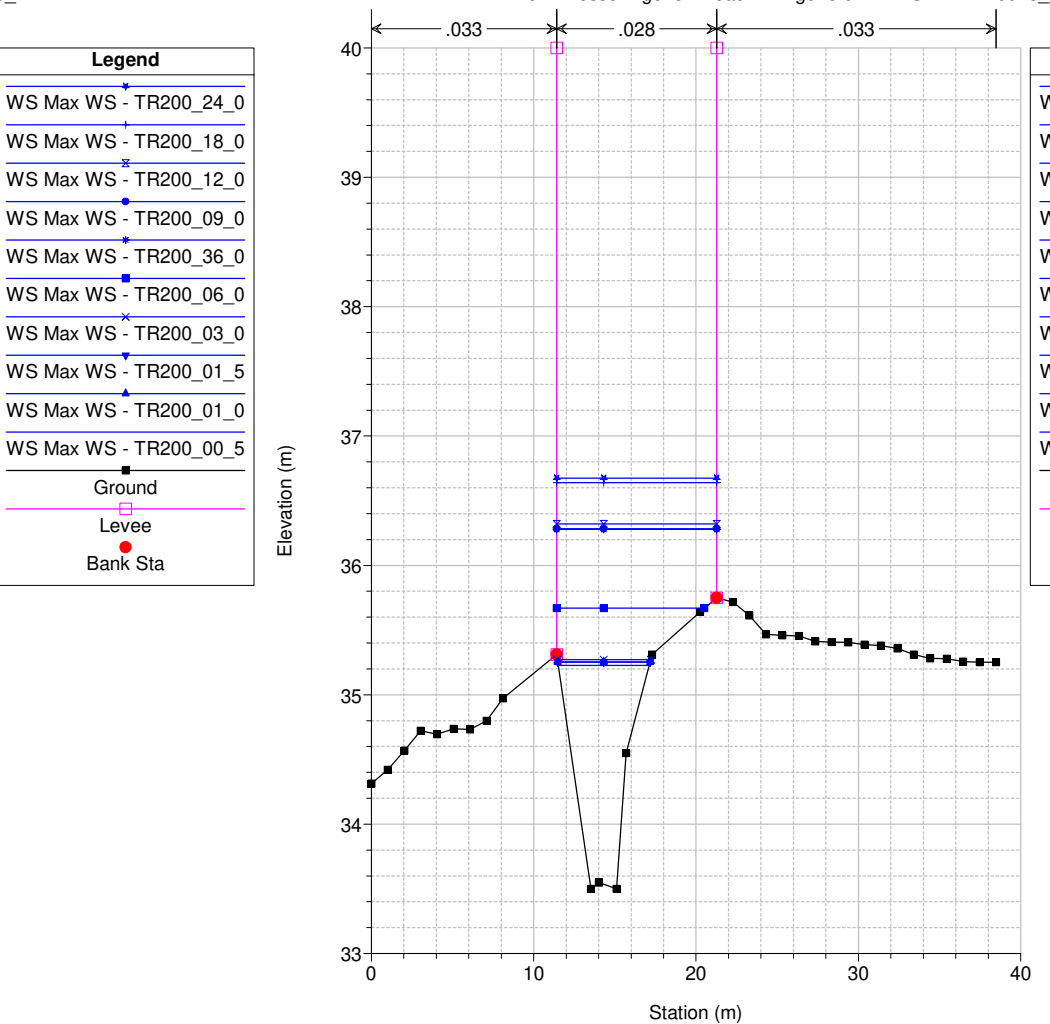

Studio Scandicci Torrenti Greve-Vingone
River = Fosso Rigone Reach = Rigone 02 RS = 23.5 BR

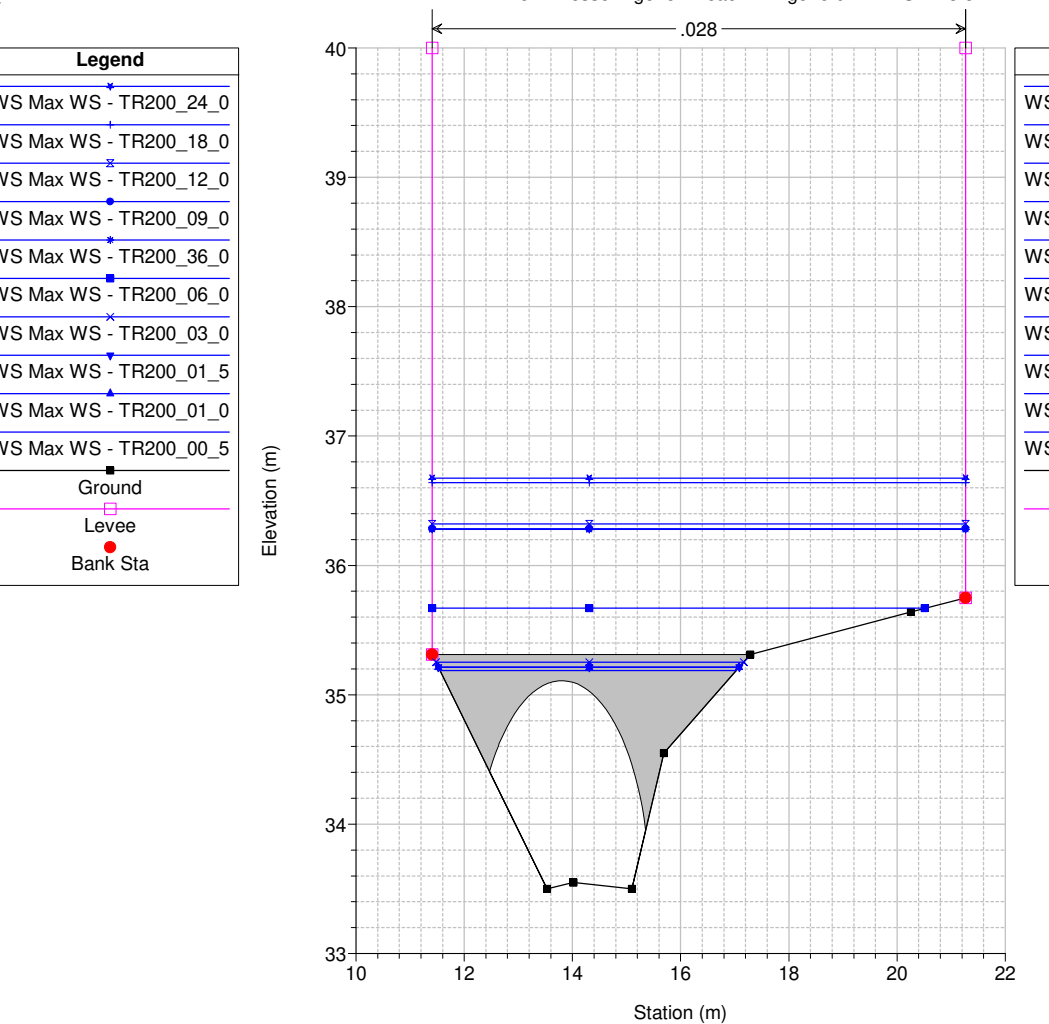

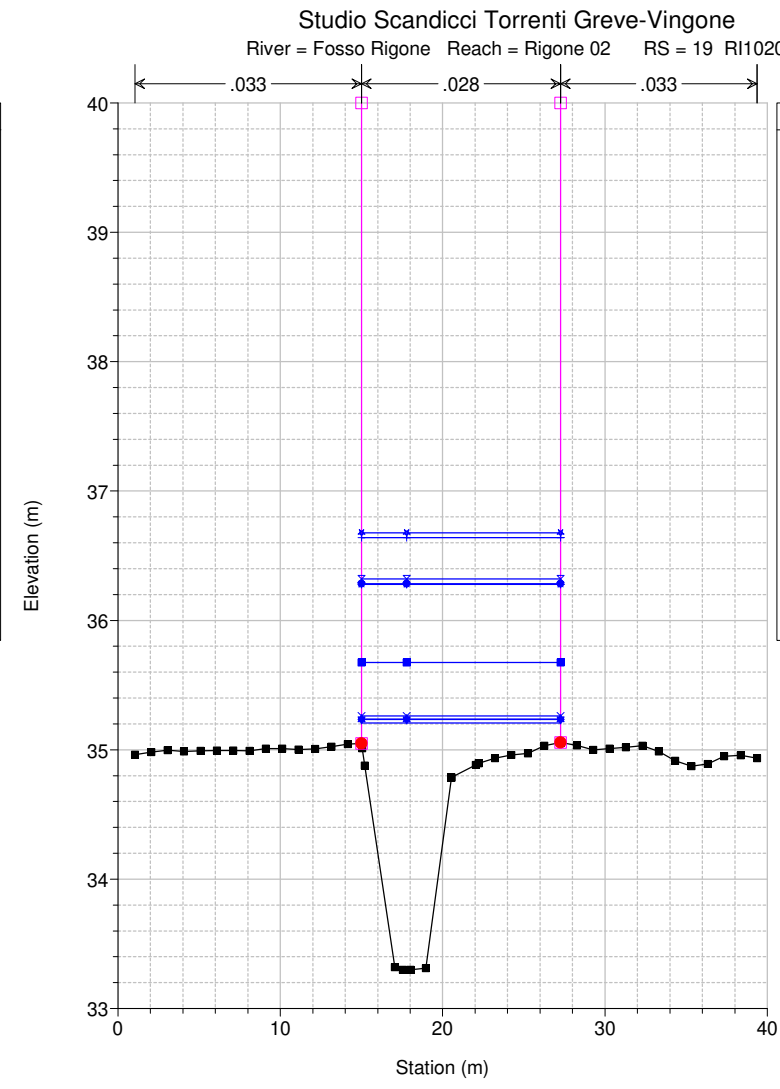
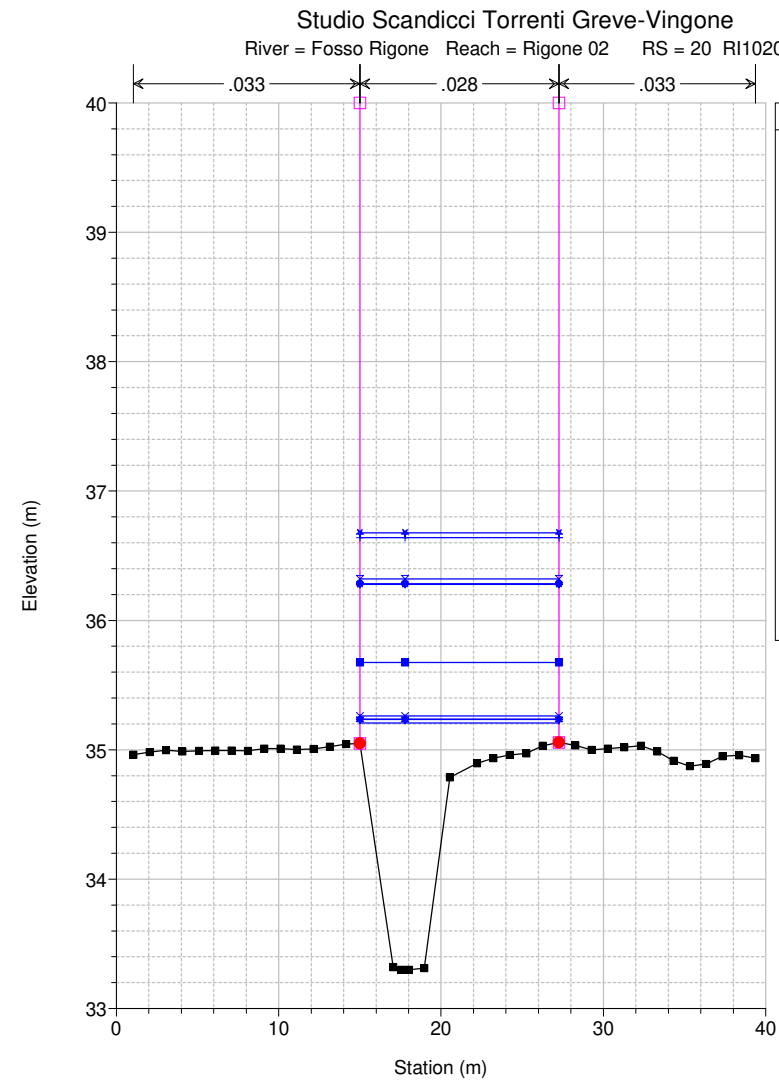
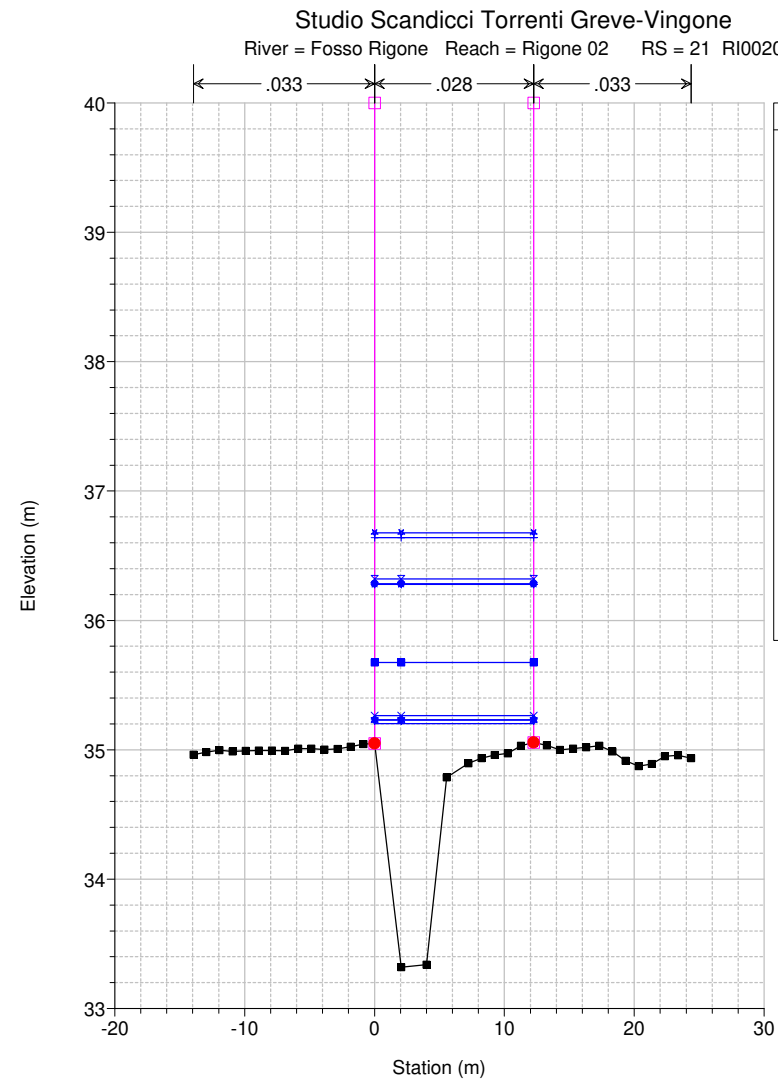
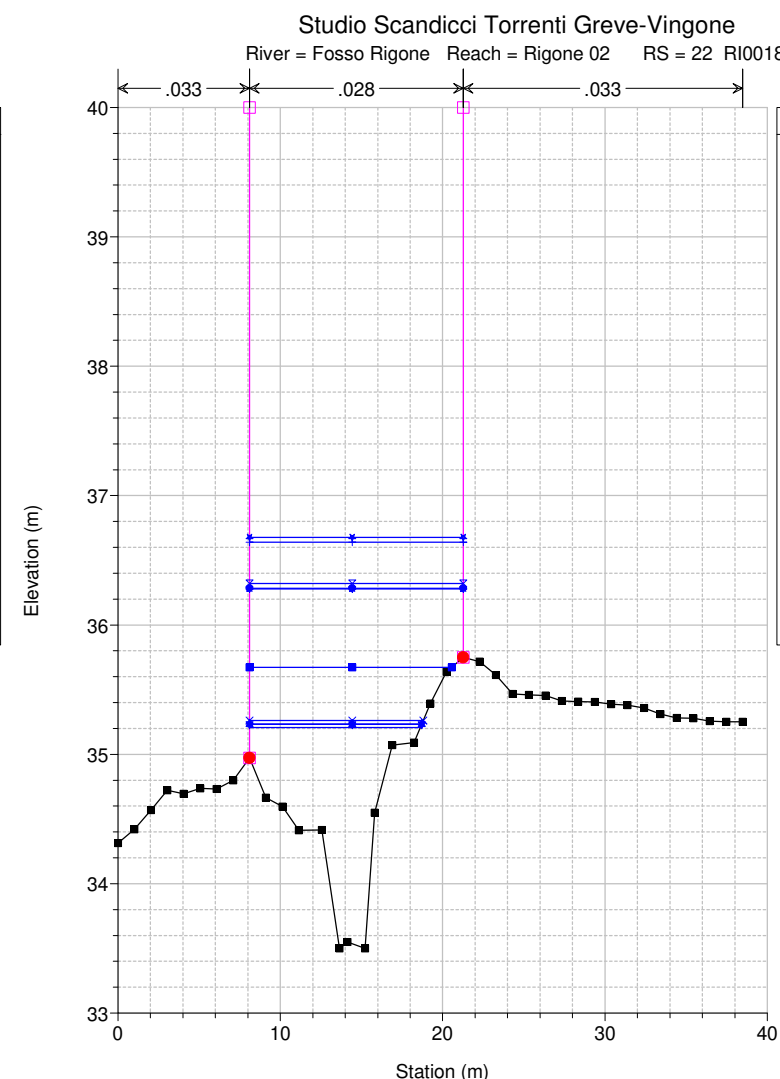
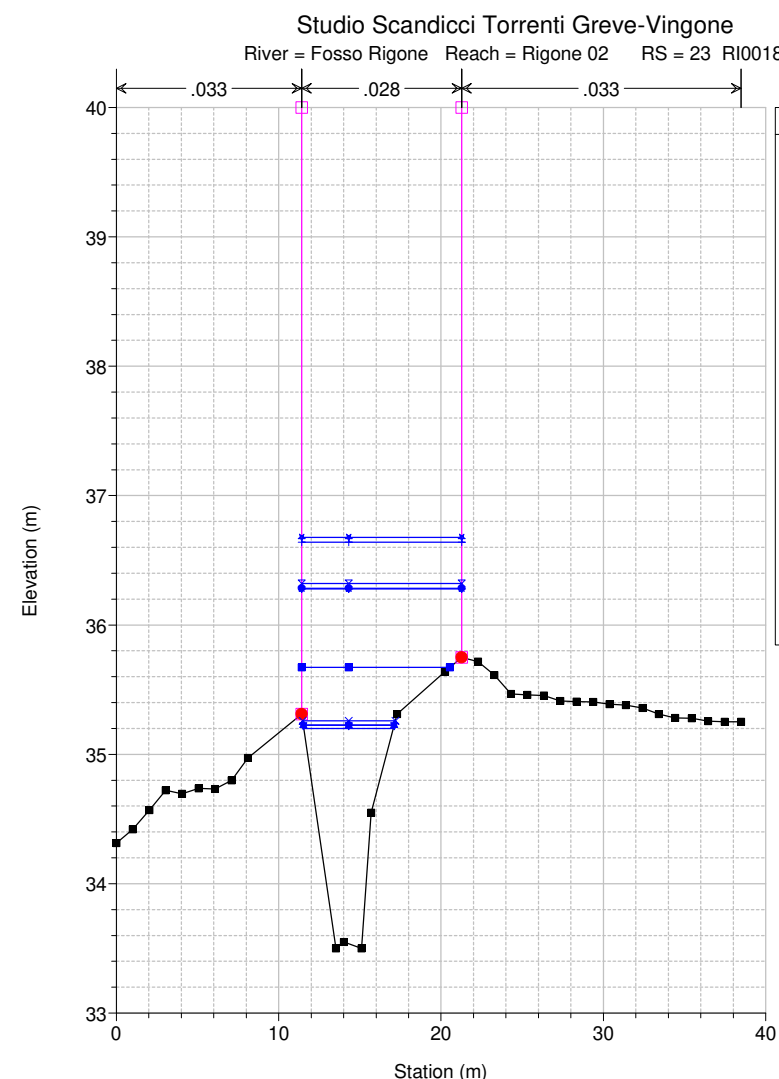
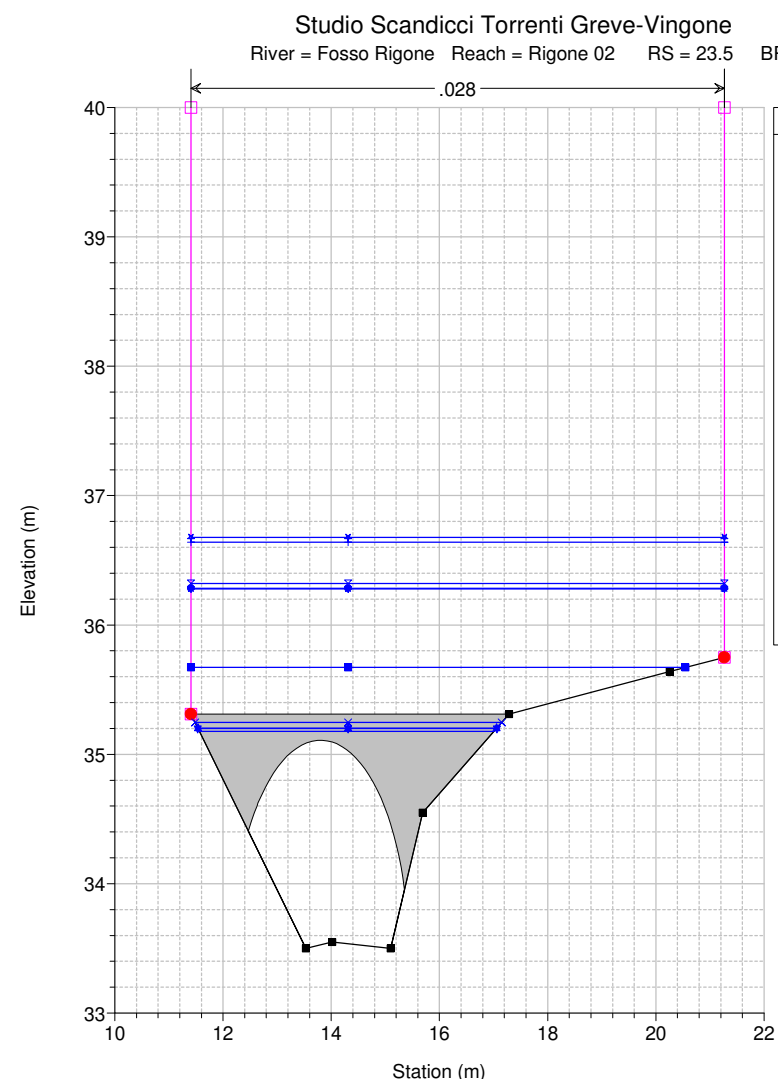

Studio Scandicci Torrenti Greve-Vingone
River = Fosso Rigone Reach = Rigone 02 RS = 18.5 BR

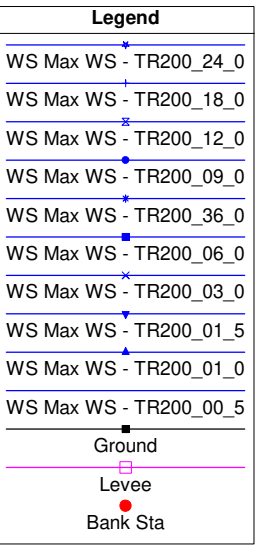
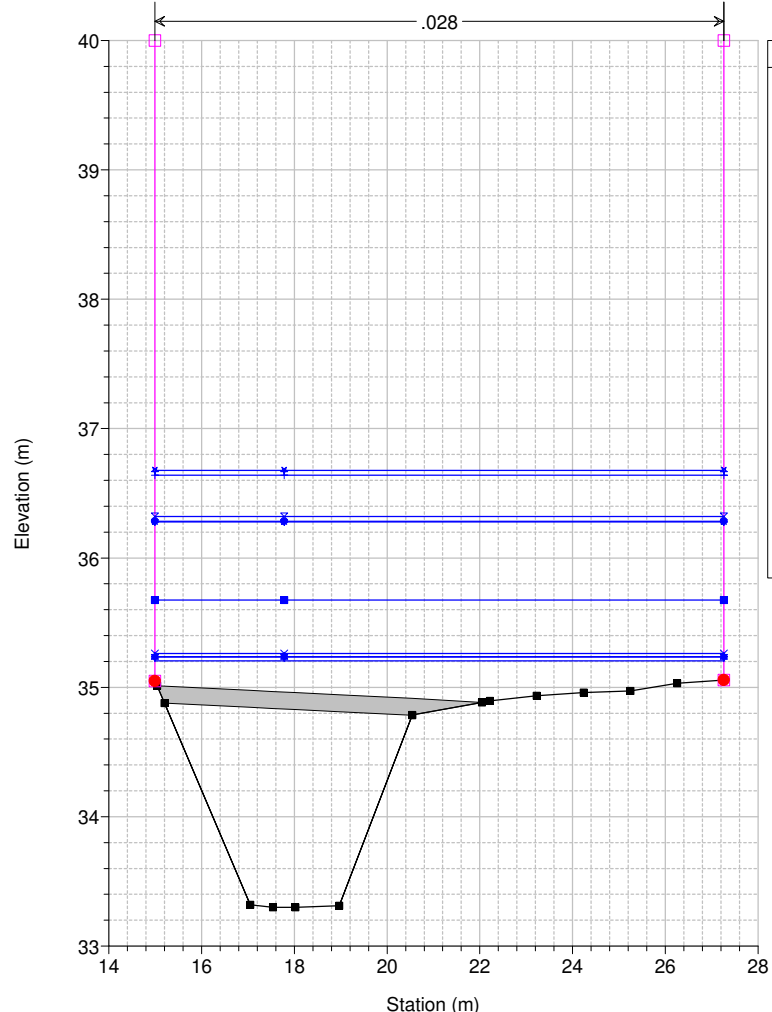

Studio Scandicci Torrenti Greve-Vingone
River = Fosso Rigone Reach = Rigone 02 RS = 18.5 BR

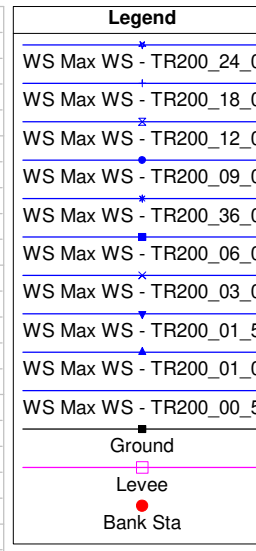
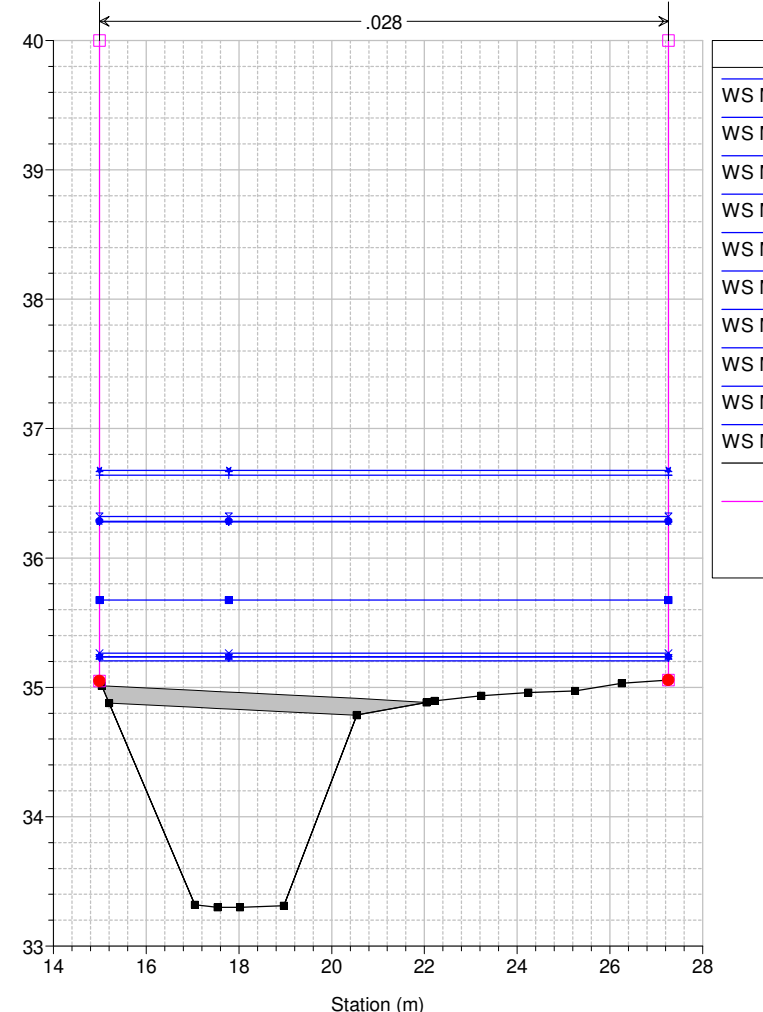

Studio Scandicci Torrenti Greve-Vingone
River = Fosso Rigone Reach = Rigone 02 RS = 18 RI1020_C

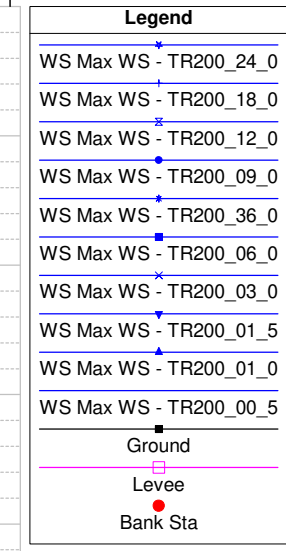
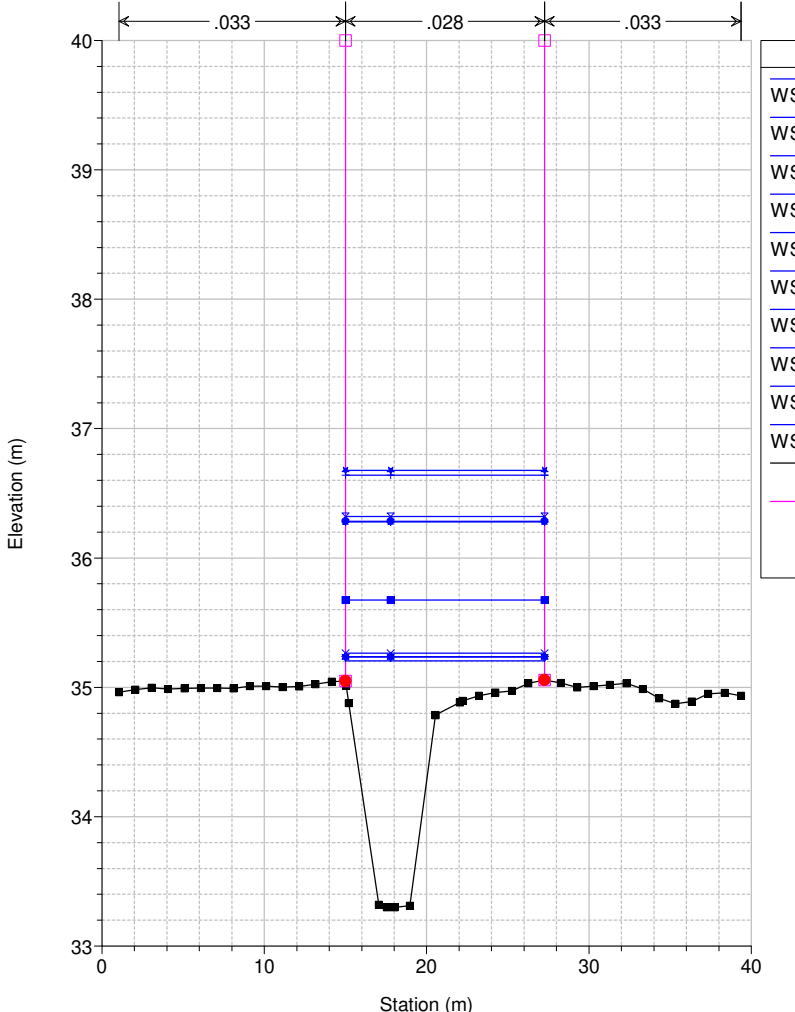

Studio Scandicci Torrenti Greve-Vingone
River = Fosso Rigone Reach = Rigone 02 RS = 17 RI1020_D

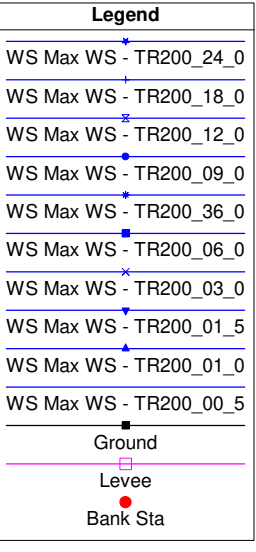
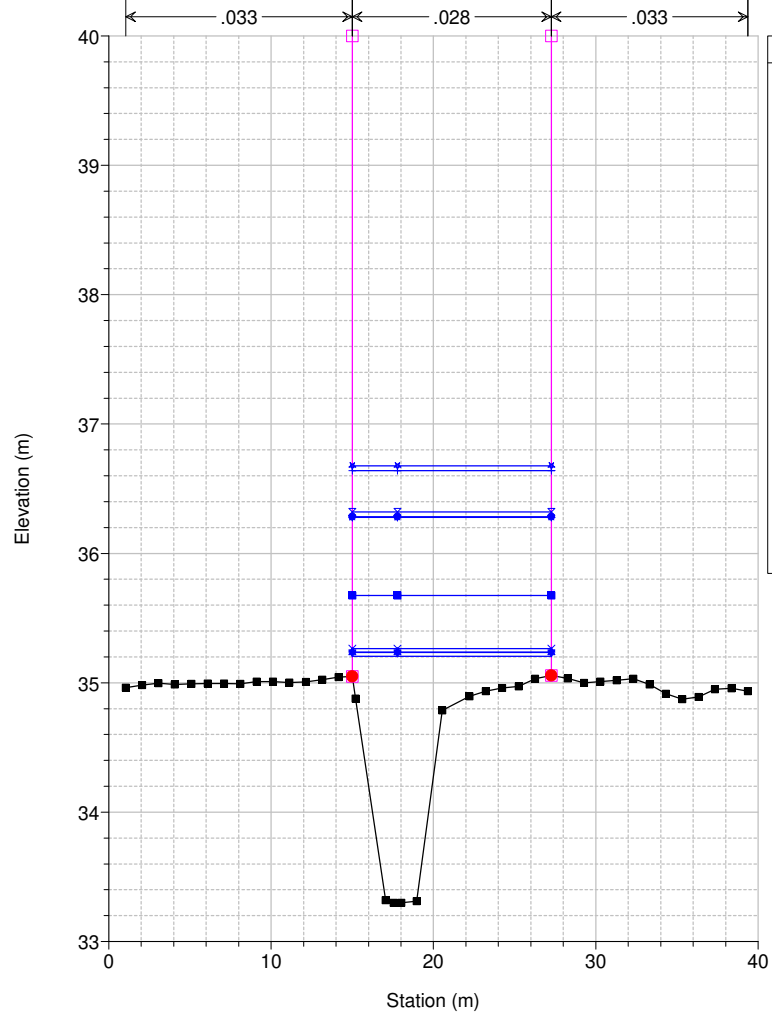

Studio Scandicci Torrenti Greve-Vingone
River = Fosso Rigone Reach = Rigone 02 RS = 16 RI0021_A

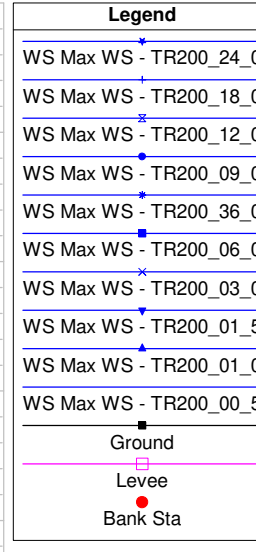
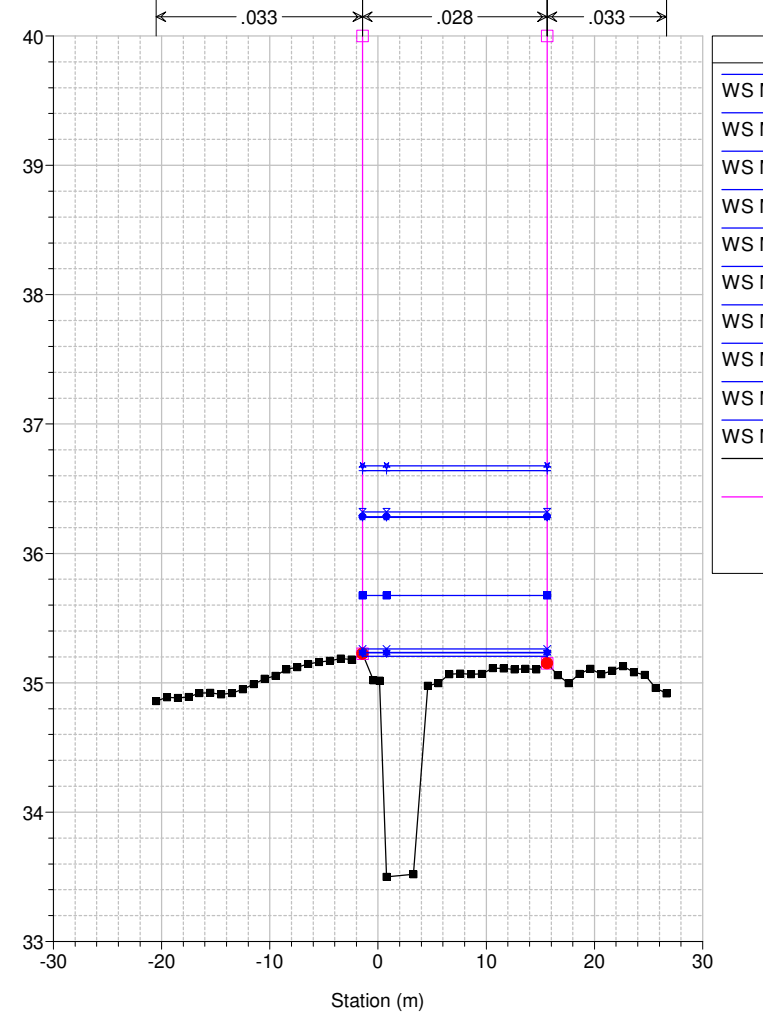

Studio Scandicci Torrenti Greve-Vingone
River = Fosso Rigone Reach = Rigone 02 RS = 15 RI0021_B

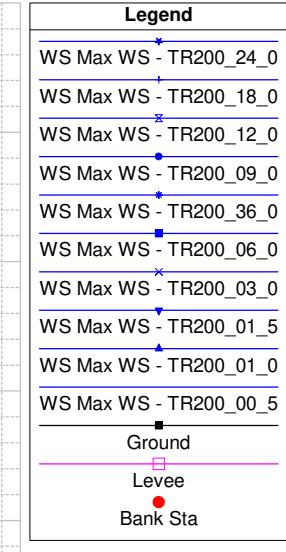
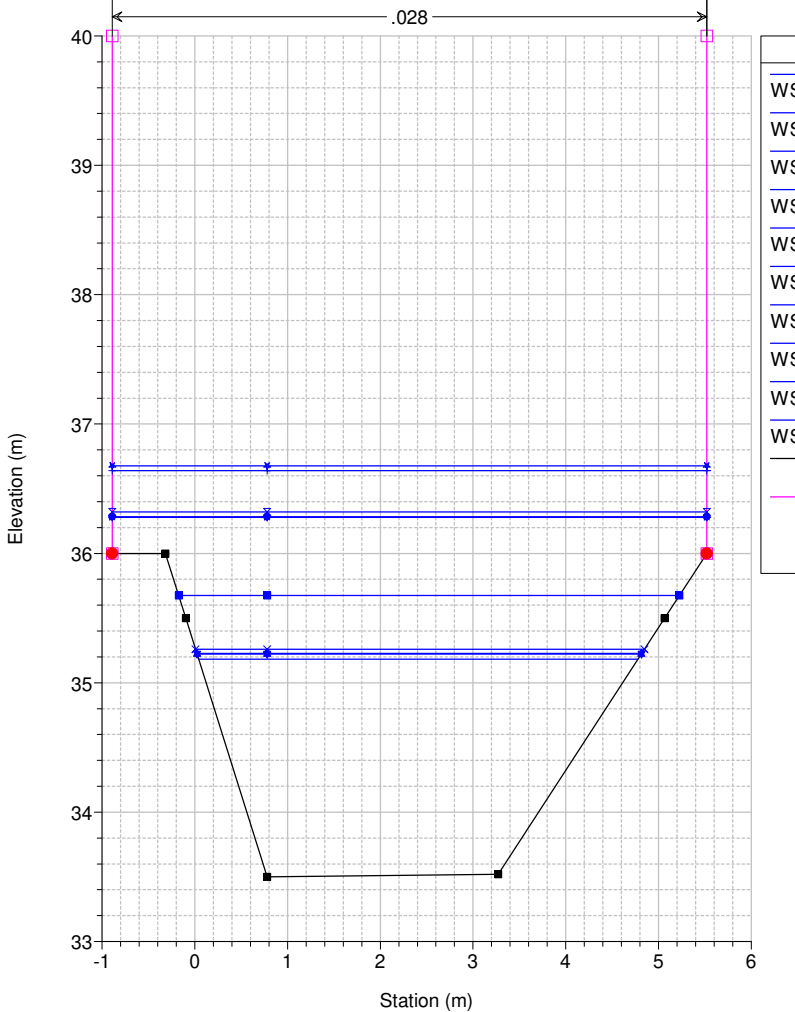

Studio Scandicci Torrenti Greve-Vingone
River = Fosso Rigone Reach = Rigone 02 RS = 14.75 BR

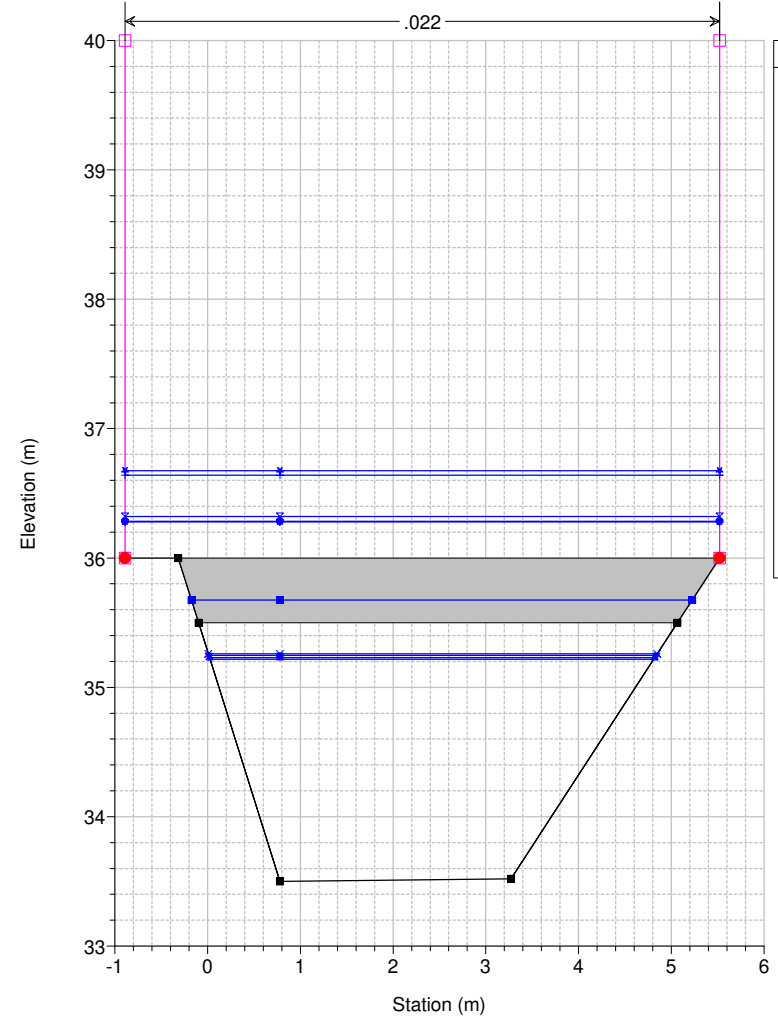

Legend	
WS Max WS - TR200_24_0	+
WS Max WS - TR200_18_0	+
WS Max WS - TR200_12_0	+
WS Max WS - TR200_09_0	+
WS Max WS - TR200_36_0	+
WS Max WS - TR200_06_0	+
WS Max WS - TR200_03_0	+
WS Max WS - TR200_01_5	+
WS Max WS - TR200_01_0	+
WS Max WS - TR200_00_5	+
Ground	■
Levee	□
Bank Sta	●

Studio Scandicci Torrenti Greve-Vingone
River = Fosso Rigone Reach = Rigone 02 RS = 14.75 BR

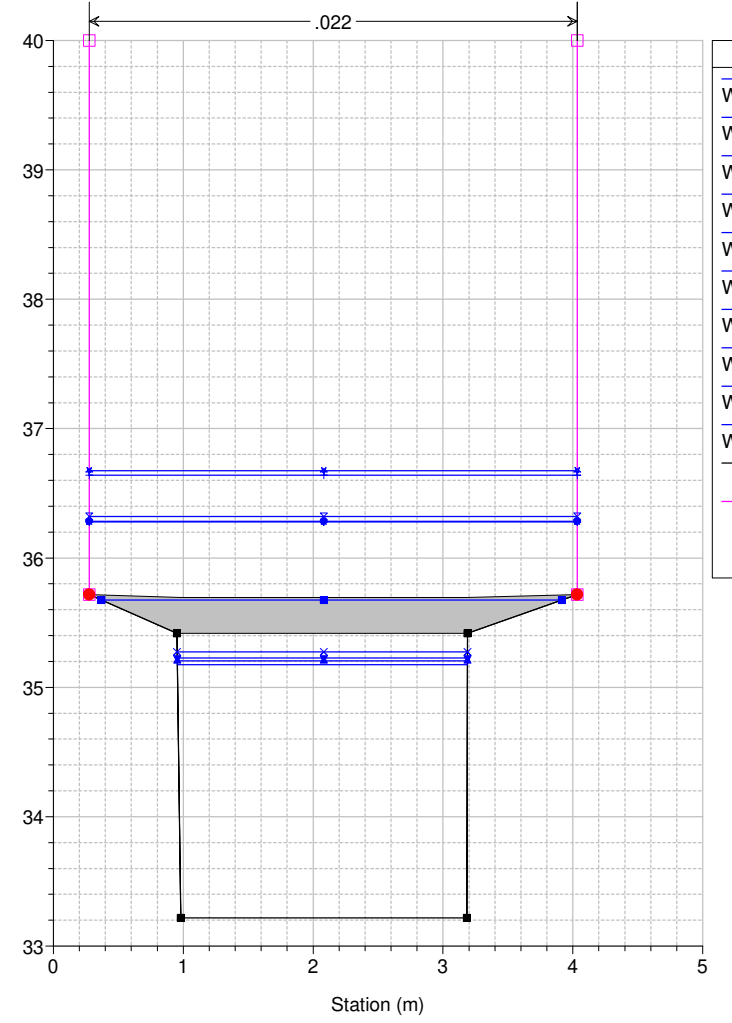

Legend	
WS Max WS - TR200_24_0	+
WS Max WS - TR200_18_0	+
WS Max WS - TR200_12_0	+
WS Max WS - TR200_09_0	+
WS Max WS - TR200_36_0	+
WS Max WS - TR200_06_0	+
WS Max WS - TR200_03_0	+
WS Max WS - TR200_01_5	+
WS Max WS - TR200_01_0	+
WS Max WS - TR200_00_5	+
Ground	■
Levee	□
Bank Sta	●

Studio Scandicci Torrenti Greve-Vingone
River = Fosso Rigone Reach = Rigone 02 RS = 14.4

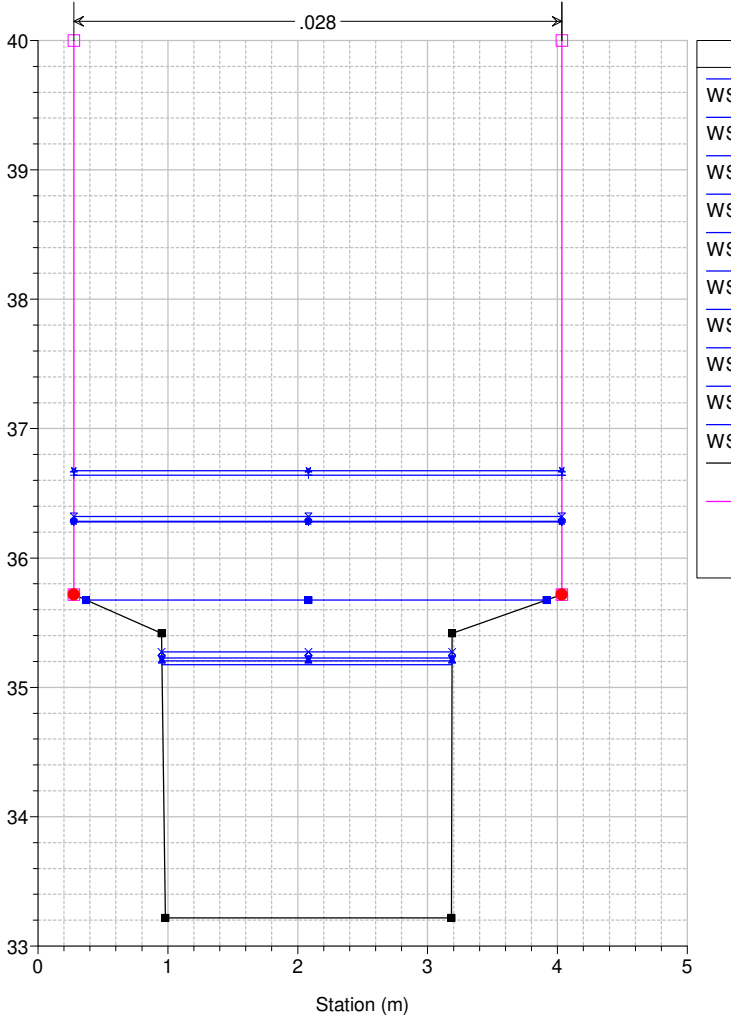

Legend	
WS Max WS - TR200_24_0	+
WS Max WS - TR200_18_0	+
WS Max WS - TR200_12_0	+
WS Max WS - TR200_09_0	+
WS Max WS - TR200_36_0	+
WS Max WS - TR200_06_0	+
WS Max WS - TR200_03_0	+
WS Max WS - TR200_01_5	+
WS Max WS - TR200_01_0	+
WS Max WS - TR200_00_5	+
Ground	■
Levee	□
Bank Sta	●

Studio Scandicci Torrenti Greve-Vingone
River = Fosso Rigone Reach = Rigone 02 RS = 14 R10021_C

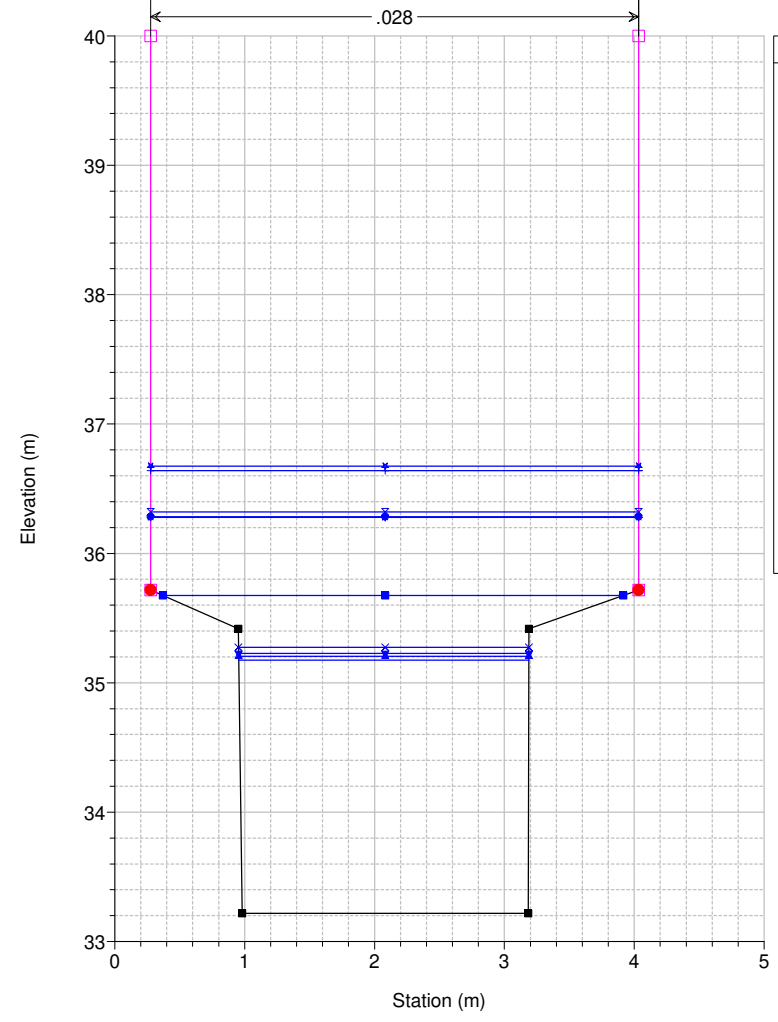

Legend	
WS Max WS - TR200_24_0	+
WS Max WS - TR200_18_0	+
WS Max WS - TR200_12_0	+
WS Max WS - TR200_09_0	+
WS Max WS - TR200_36_0	+
WS Max WS - TR200_06_0	+
WS Max WS - TR200_03_0	+
WS Max WS - TR200_01_5	+
WS Max WS - TR200_01_0	+
WS Max WS - TR200_00_5	+
Ground	■
Levee	□
Bank Sta	●

Studio Scandicci Torrenti Greve-Vingone
River = Fosso Rigone Reach = Rigone 02 RS = 13.75 Culv

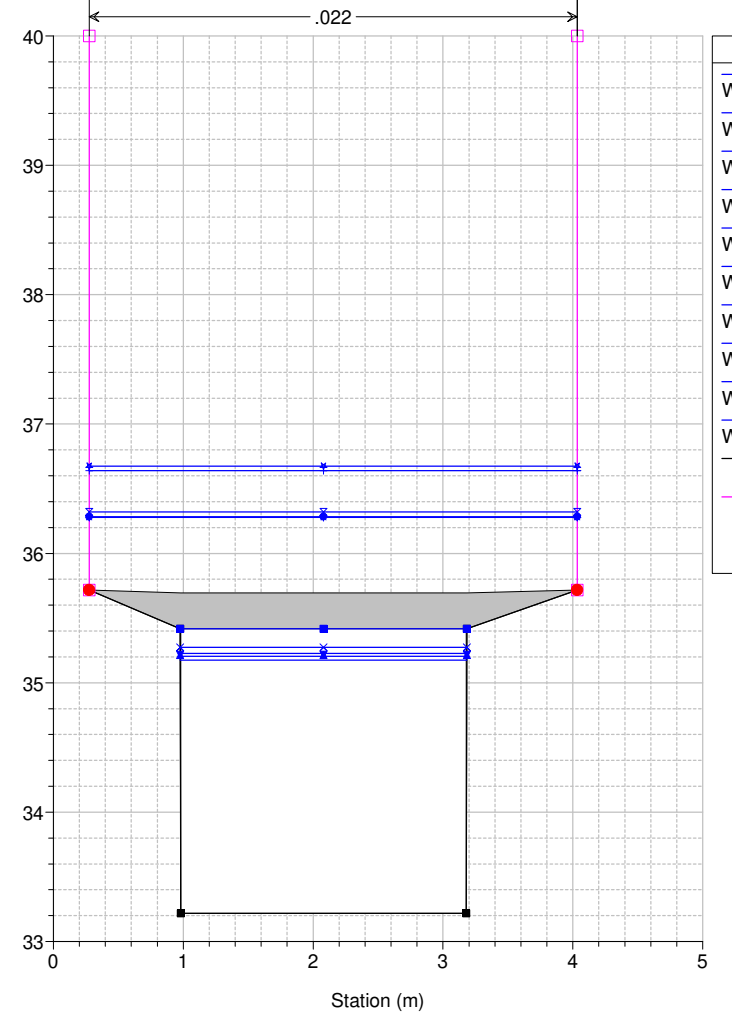

Legend	
WS Max WS - TR200_24_0	+
WS Max WS - TR200_18_0	+
WS Max WS - TR200_12_0	+
WS Max WS - TR200_09_0	+
WS Max WS - TR200_36_0	+
WS Max WS - TR200_06_0	+
WS Max WS - TR200_03_0	+
WS Max WS - TR200_01_5	+
WS Max WS - TR200_01_0	+
WS Max WS - TR200_00_5	+
Ground	■
Levee	□
Bank Sta	●

Studio Scandicci Torrenti Greve-Vingone
River = Fosso Rigone Reach = Rigone 02 RS = 13.75 Culv

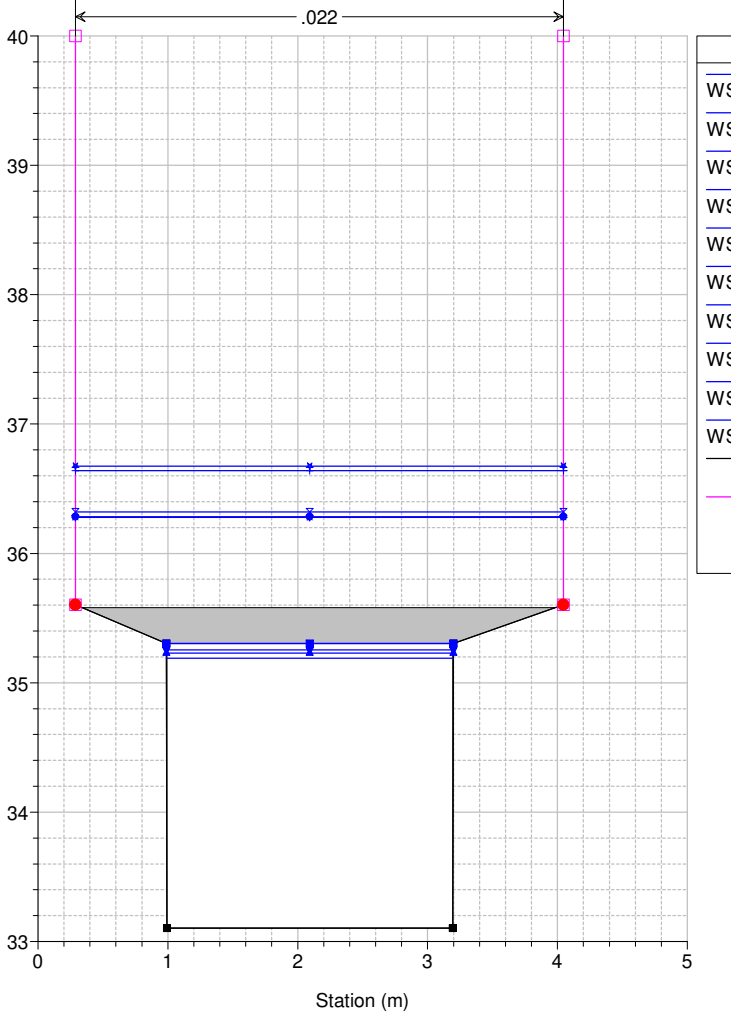

Legend	
WS Max WS - TR200_24_0	+
WS Max WS - TR200_18_0	+
WS Max WS - TR200_12_0	+
WS Max WS - TR200_09_0	+
WS Max WS - TR200_36_0	+
WS Max WS - TR200_06_0	+
WS Max WS - TR200_03_0	+
WS Max WS - TR200_01_5	+
WS Max WS - TR200_01_0	+
WS Max WS - TR200_00_5	+
Ground	■
Levee	□
Bank Sta	●

Studio Scandicci Torrenti Greve-Vingone
River = Fosso Rigone Reach = Rigone 02 RS = 13.4

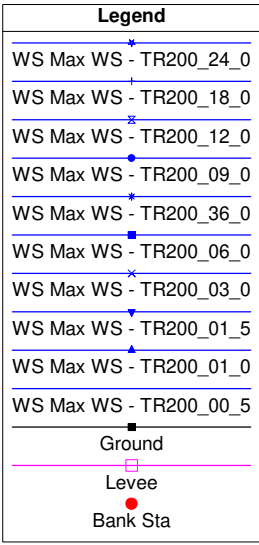
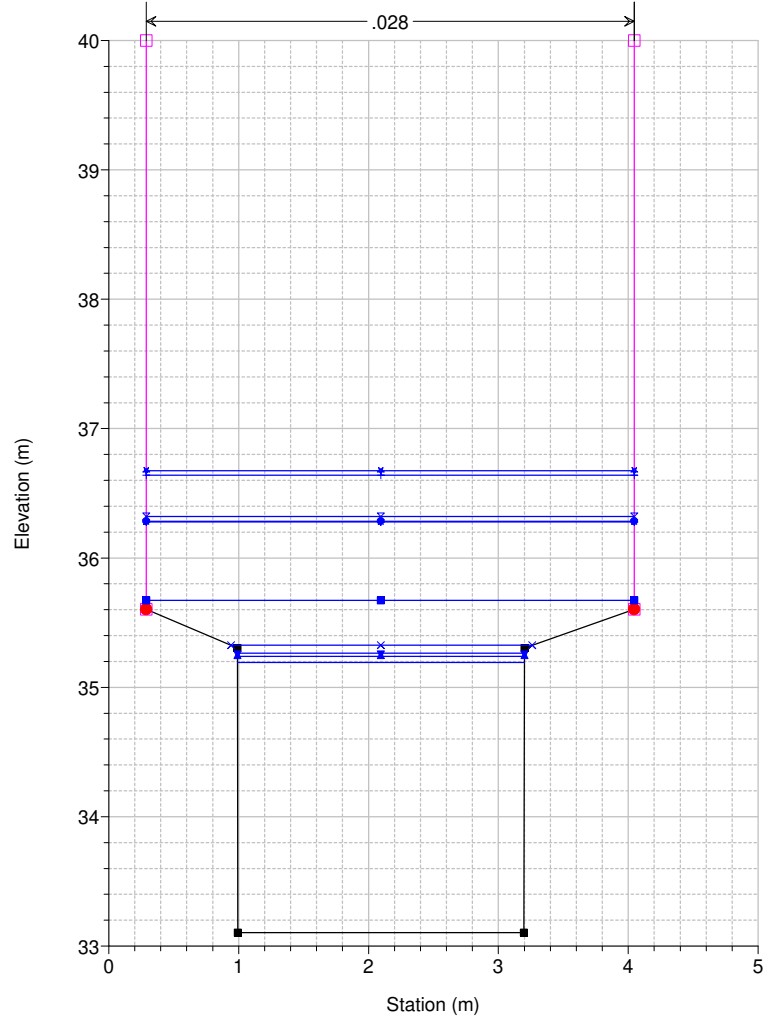

Studio Scandicci Torrenti Greve-Vingone
River = Fosso Rigone Reach = Rigone 02 RS = 13 RI0021_D

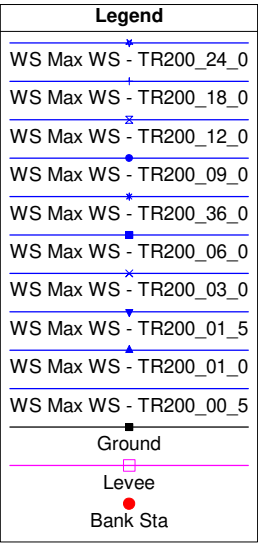
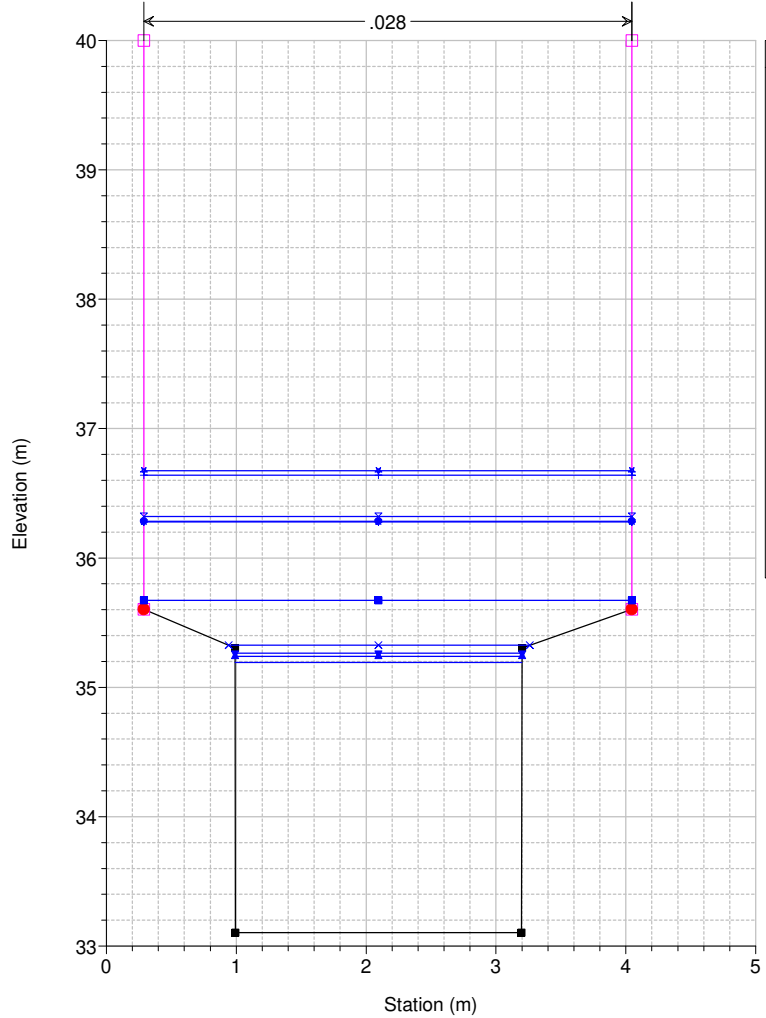

Studio Scandicci Torrenti Greve-Vingone
River = Fosso Rigone Reach = Rigone 02 RS = 12.75 BR

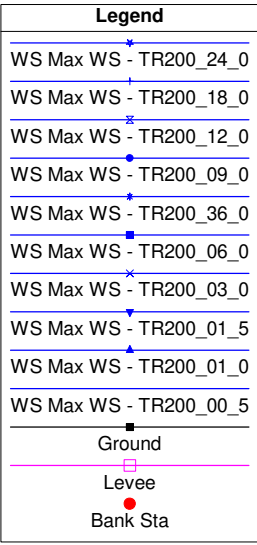
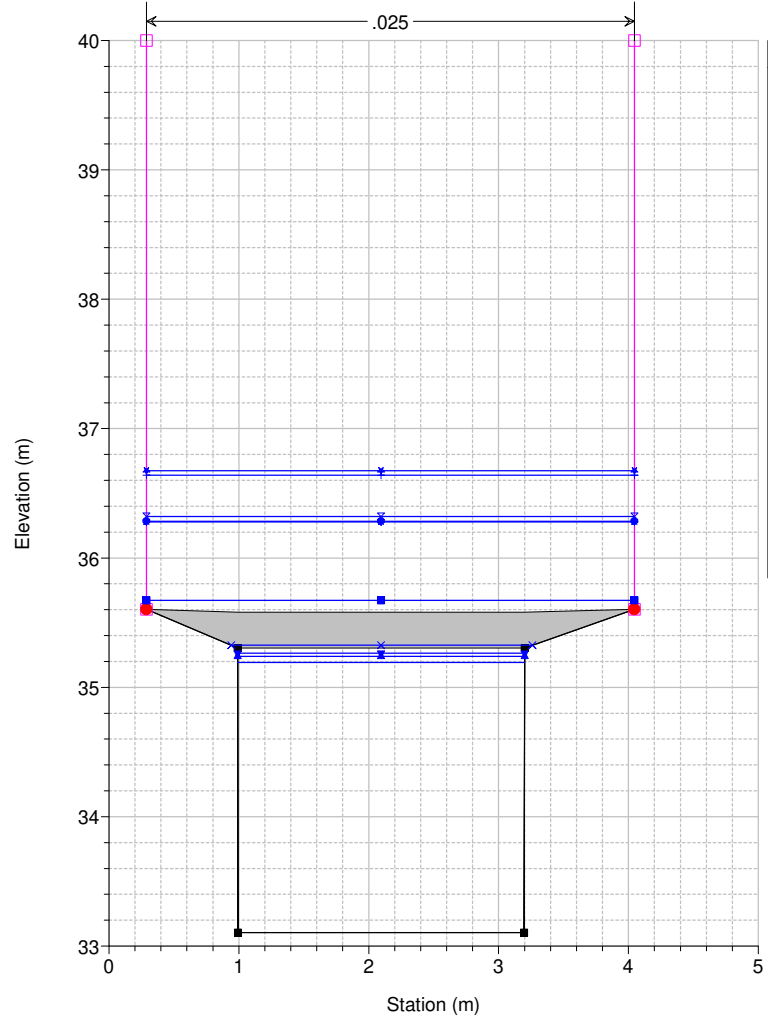

Studio Scandicci Torrenti Greve-Vingone
River = Fosso Rigone Reach = Rigone 02 RS = 12.75 BR

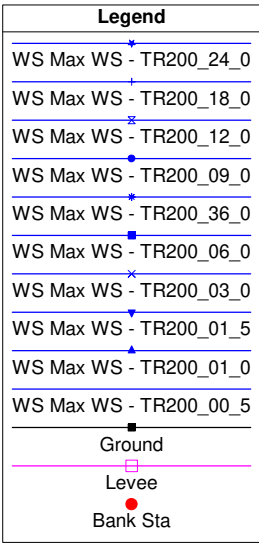
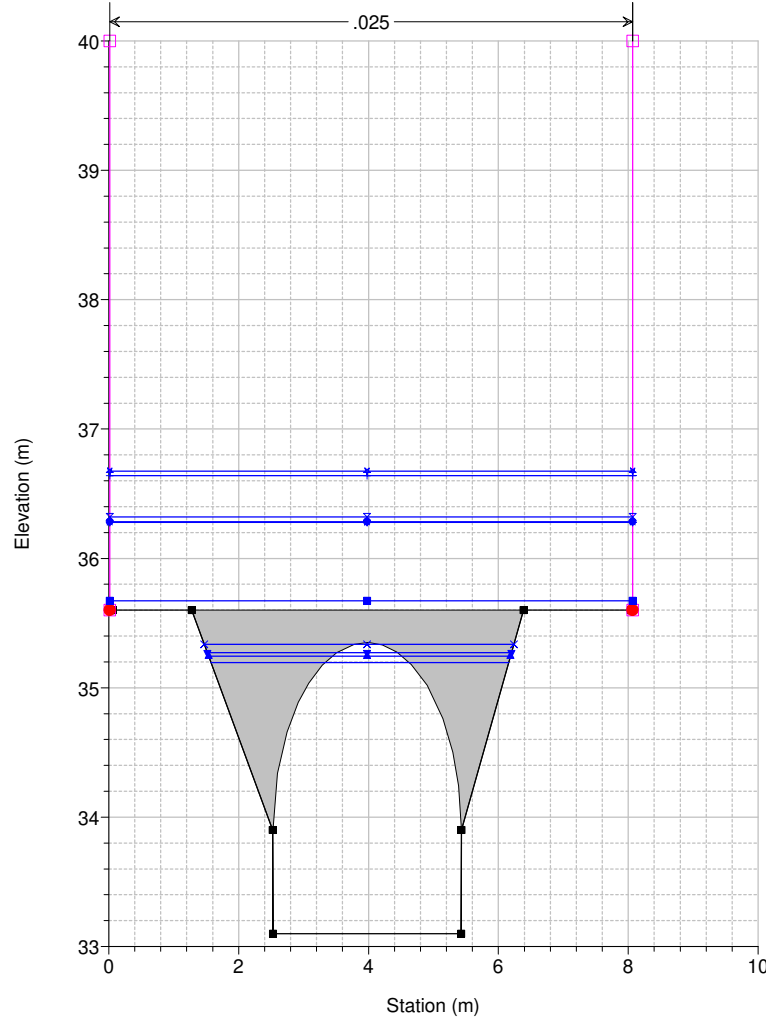

Studio Scandicci Torrenti Greve-Vingone
River = Fosso Rigone Reach = Rigone 02 RS = 12.4

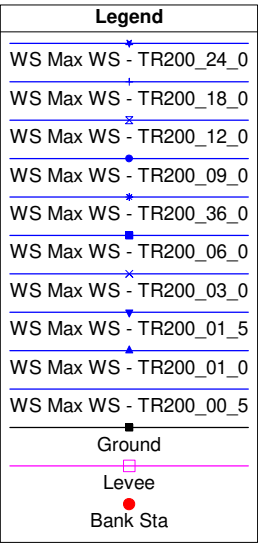
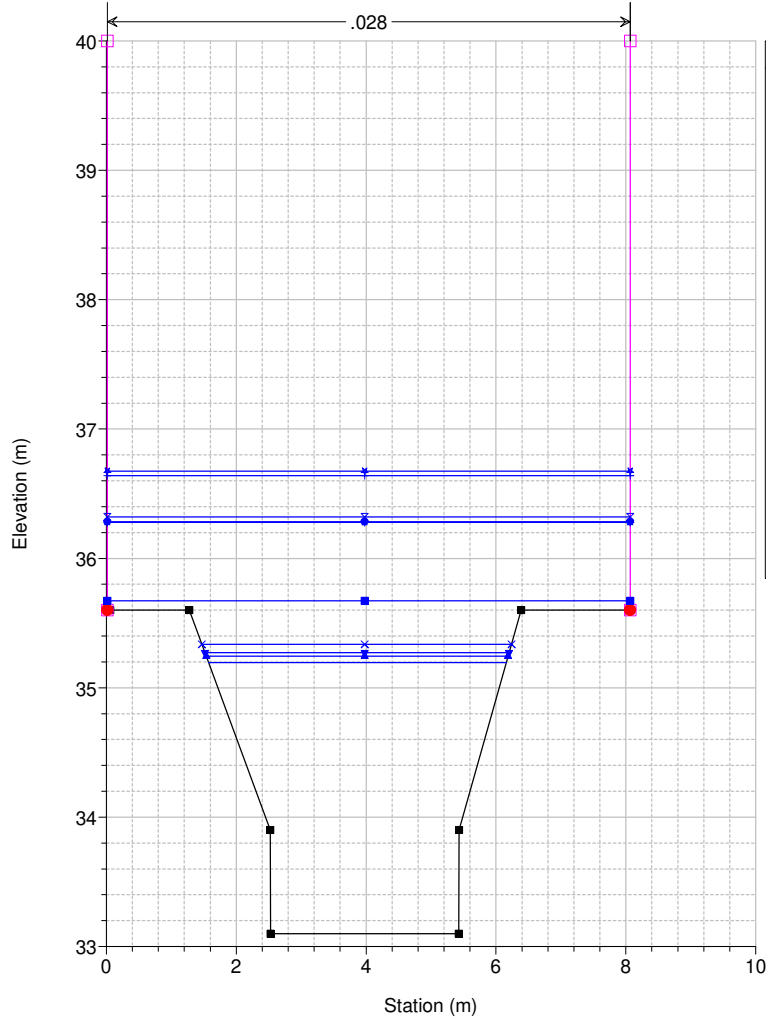

Studio Scandicci Torrenti Greve-Vingone
River = Fosso Rigone Reach = Rigone 02 RS = 12 RI0022_B

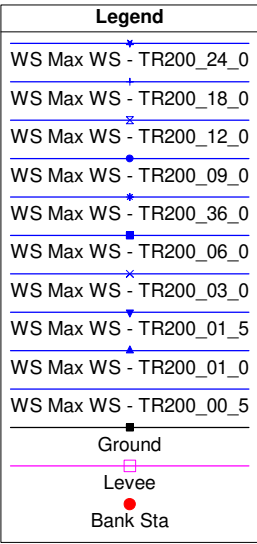
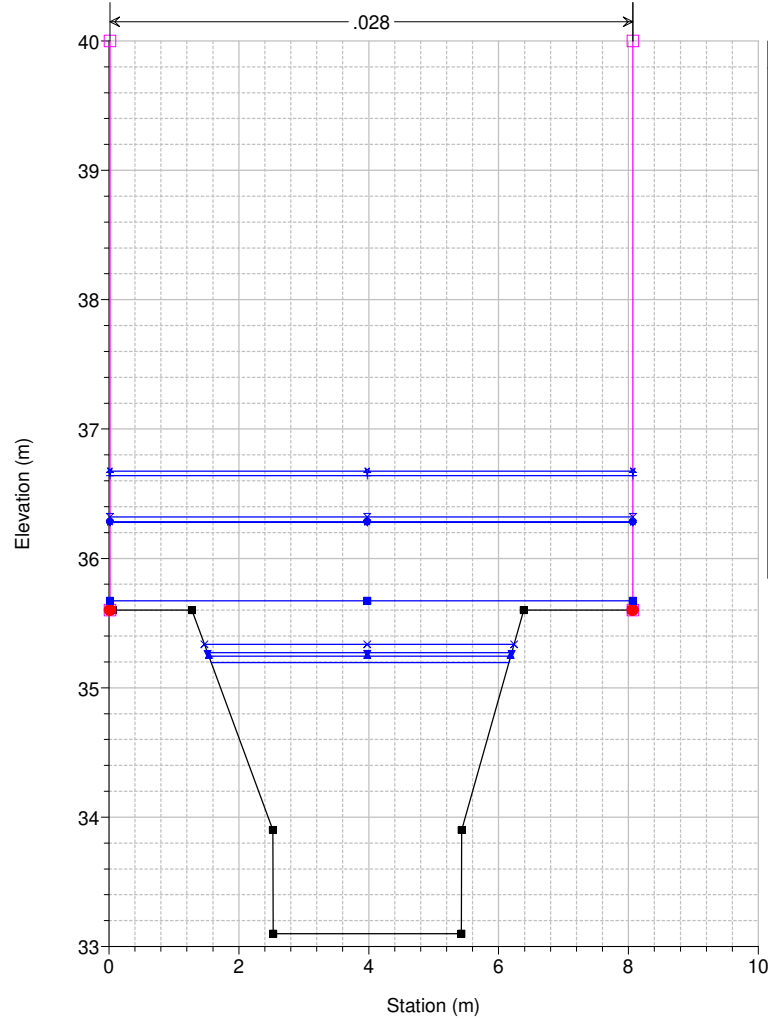

Studio Scandicci Torrenti Greve-Vingone
River = Fosso Rigone Reach = Rigone 02 RS = 11.5 BR

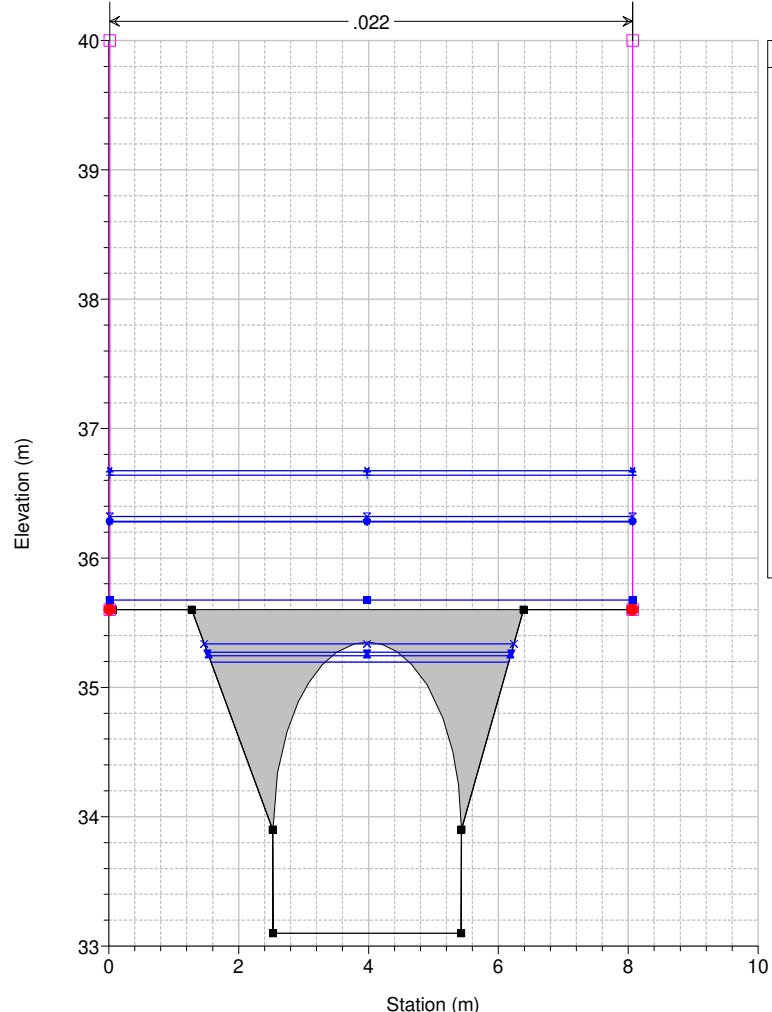

Legend	
WS Max WS - TR200_24_0	+
WS Max WS - TR200_18_0	+
WS Max WS - TR200_12_0	+
WS Max WS - TR200_09_0	+
WS Max WS - TR200_36_0	+
WS Max WS - TR200_06_0	+
WS Max WS - TR200_03_0	+
WS Max WS - TR200_01_5	+
WS Max WS - TR200_01_0	+
WS Max WS - TR200_00_5	+
Ground	■
Levee	□
Bank Sta	●

Studio Scandicci Torrenti Greve-Vingone
River = Fosso Rigone Reach = Rigone 02 RS = 11.5 BR

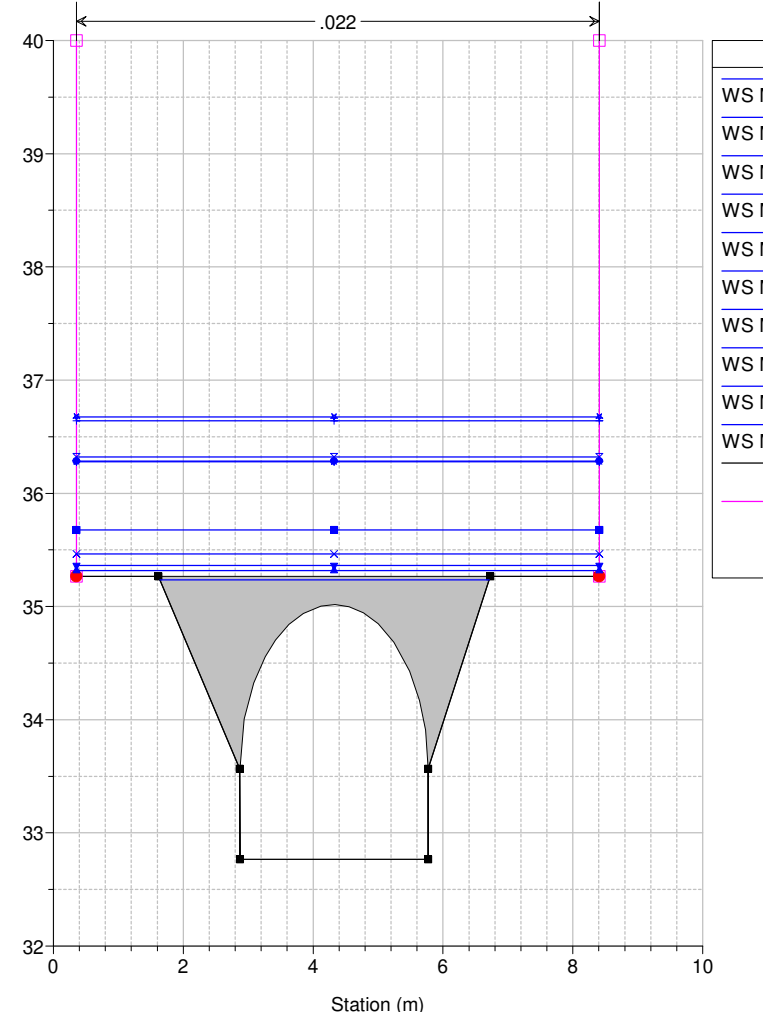

Legend	
WS Max WS - TR200_24_0	+
WS Max WS - TR200_18_0	+
WS Max WS - TR200_12_0	+
WS Max WS - TR200_09_0	+
WS Max WS - TR200_36_0	+
WS Max WS - TR200_06_0	+
WS Max WS - TR200_03_0	+
WS Max WS - TR200_01_5	+
WS Max WS - TR200_01_0	+
WS Max WS - TR200_00_5	+
Ground	■
Levee	□
Bank Sta	●

Studio Scandicci Torrenti Greve-Vingone
River = Fosso Rigone Reach = Rigone 02 RS = 11 RI0022_C

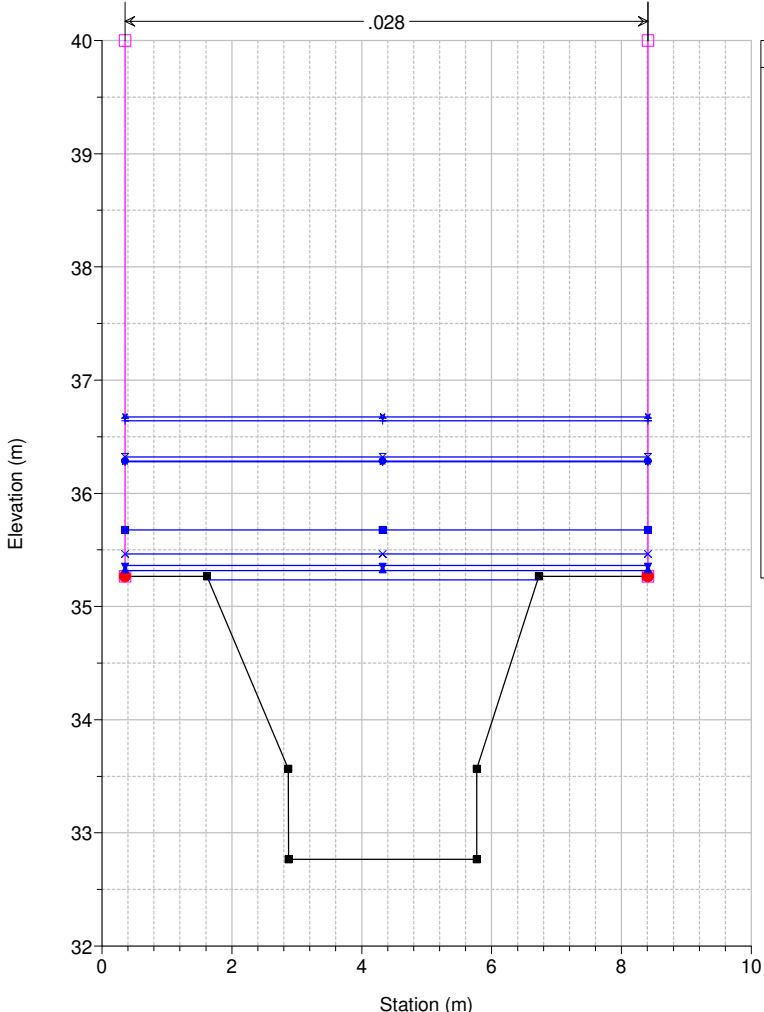

Legend	
WS Max WS - TR200_24_0	+
WS Max WS - TR200_18_0	+
WS Max WS - TR200_12_0	+
WS Max WS - TR200_09_0	+
WS Max WS - TR200_36_0	+
WS Max WS - TR200_06_0	+
WS Max WS - TR200_03_0	+
WS Max WS - TR200_01_5	+
WS Max WS - TR200_01_0	+
WS Max WS - TR200_00_5	+
Ground	■
Levee	□
Bank Sta	●

Studio Scandicci Torrenti Greve-Vingone
River = Fosso Rigone Reach = Rigone 02 RS = 10.6

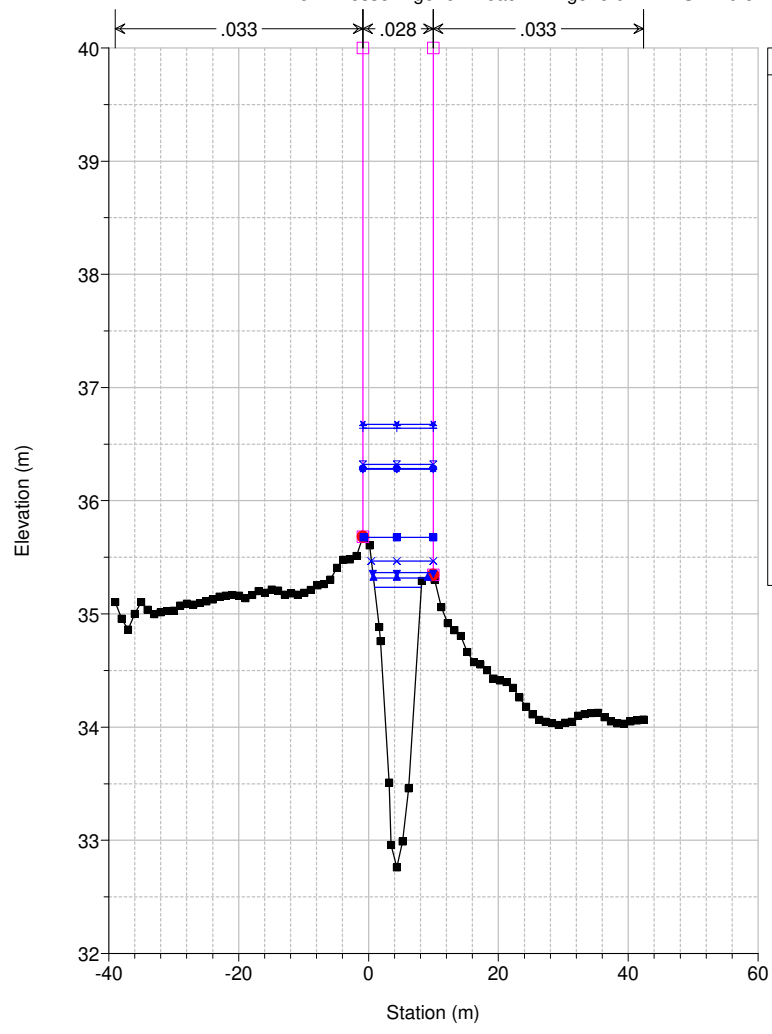

Legend	
WS Max WS - TR200_24_0	+
WS Max WS - TR200_18_0	+
WS Max WS - TR200_12_0	+
WS Max WS - TR200_09_0	+
WS Max WS - TR200_36_0	+
WS Max WS - TR200_06_0	+
WS Max WS - TR200_03_0	+
WS Max WS - TR200_01_5	+
WS Max WS - TR200_01_0	+
WS Max WS - TR200_00_5	+
Ground	■
Levee	□
Bank Sta	●

Studio Scandicci Torrenti Greve-Vingone
River = Fosso Rigone Reach = Rigone 01 RS = 10 DO0032_D

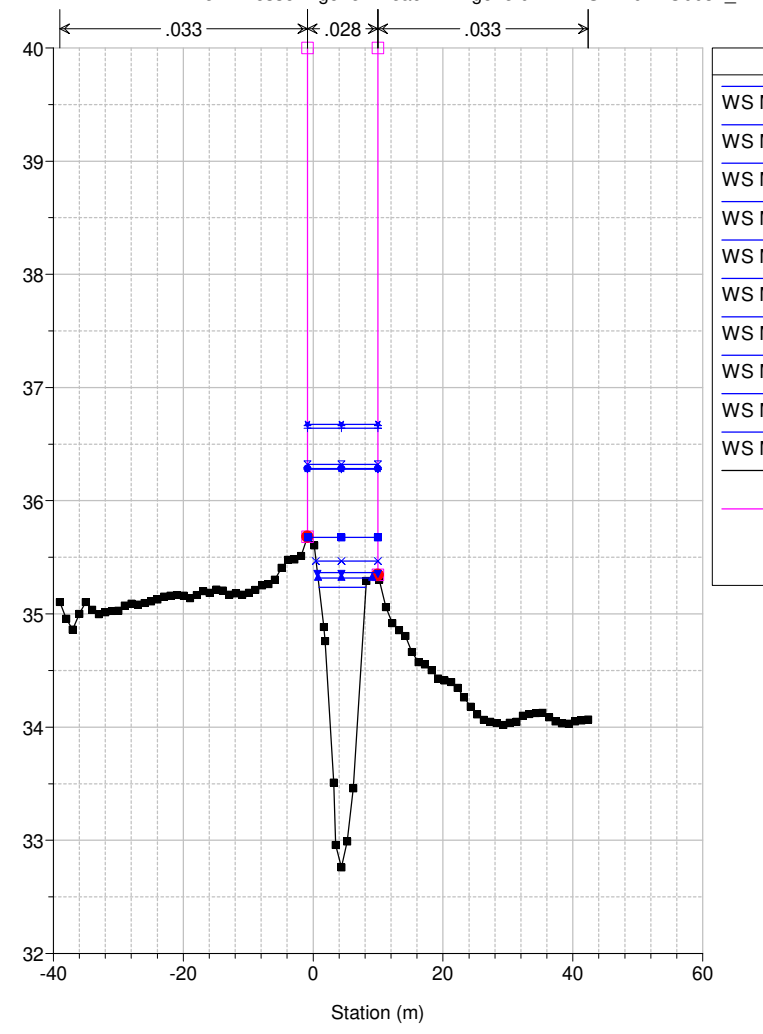

Legend	
WS Max WS - TR200_24_0	+
WS Max WS - TR200_18_0	+
WS Max WS - TR200_12_0	+
WS Max WS - TR200_09_0	+
WS Max WS - TR200_36_0	+
WS Max WS - TR200_06_0	+
WS Max WS - TR200_03_0	+
WS Max WS - TR200_01_5	+
WS Max WS - TR200_01_0	+
WS Max WS - TR200_00_5	+
Ground	■
Levee	□
Bank Sta	●

Studio Scandicci Torrenti Greve-Vingone
River = Fosso Rigone Reach = Rigone 01 RS = 9 DO1033_A

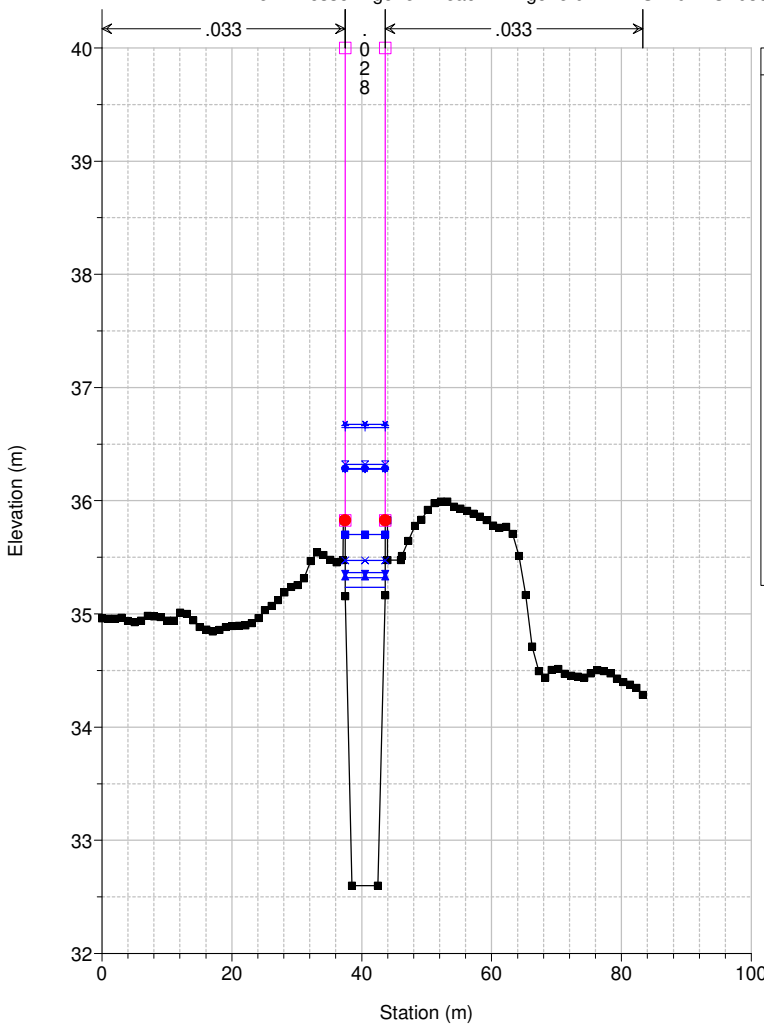

Legend	
WS Max WS - TR200_24_0	+
WS Max WS - TR200_18_0	+
WS Max WS - TR200_12_0	+
WS Max WS - TR200_09_0	+
WS Max WS - TR200_36_0	+
WS Max WS - TR200_06_0	+
WS Max WS - TR200_03_0	+
WS Max WS - TR200_01_5	+
WS Max WS - TR200_01_0	+
WS Max WS - TR200_00_5	+
Ground	■
Levee	□
Bank Sta	●

Studio Scandicci Torrenti Greve-Vingone
River = Fosso Rigone Reach = Rigone 01 RS = 8 DO1033_B

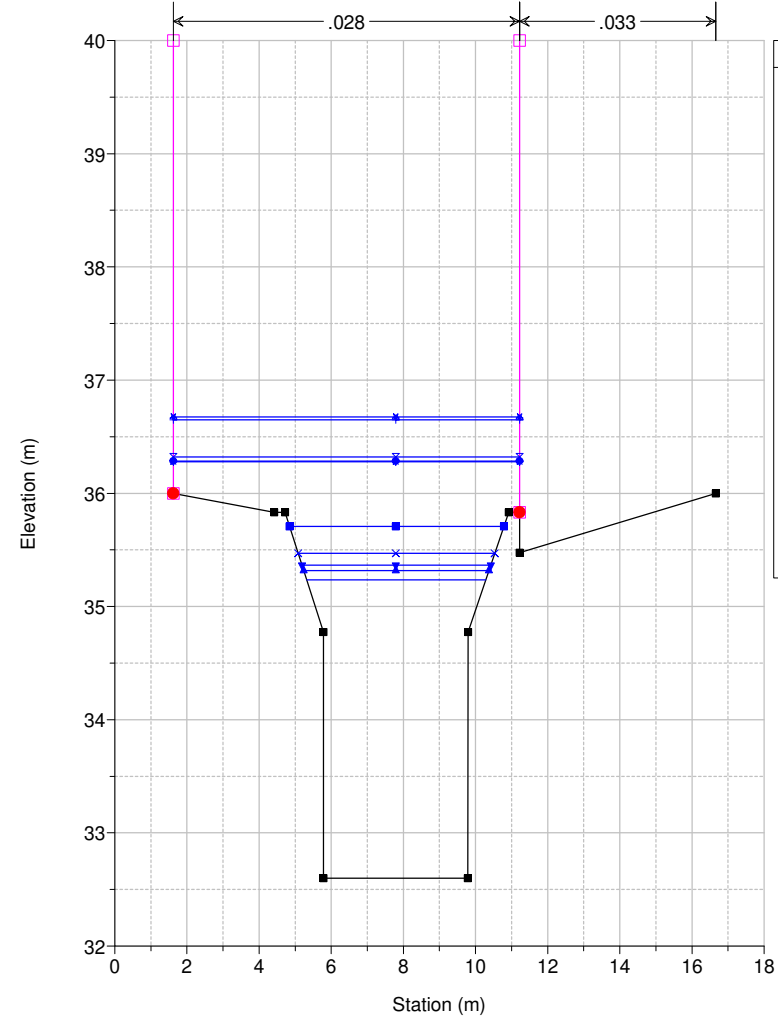

Legend	
WS Max WS - TR200_24_0	▲
WS Max WS - TR200_18_0	▲
WS Max WS - TR200_12_0	▲
WS Max WS - TR200_09_0	▲
WS Max WS - TR200_36_0	▲
WS Max WS - TR200_06_0	▲
WS Max WS - TR200_03_0	▲
WS Max WS - TR200_01_5	▲
WS Max WS - TR200_01_0	▲
WS Max WS - TR200_00_5	▲
Ground	■
Levee	□
Bank Sta	●

Studio Scandicci Torrenti Greve-Vingone
River = Fosso Rigone Reach = Rigone 01 RS = 7.5 BR

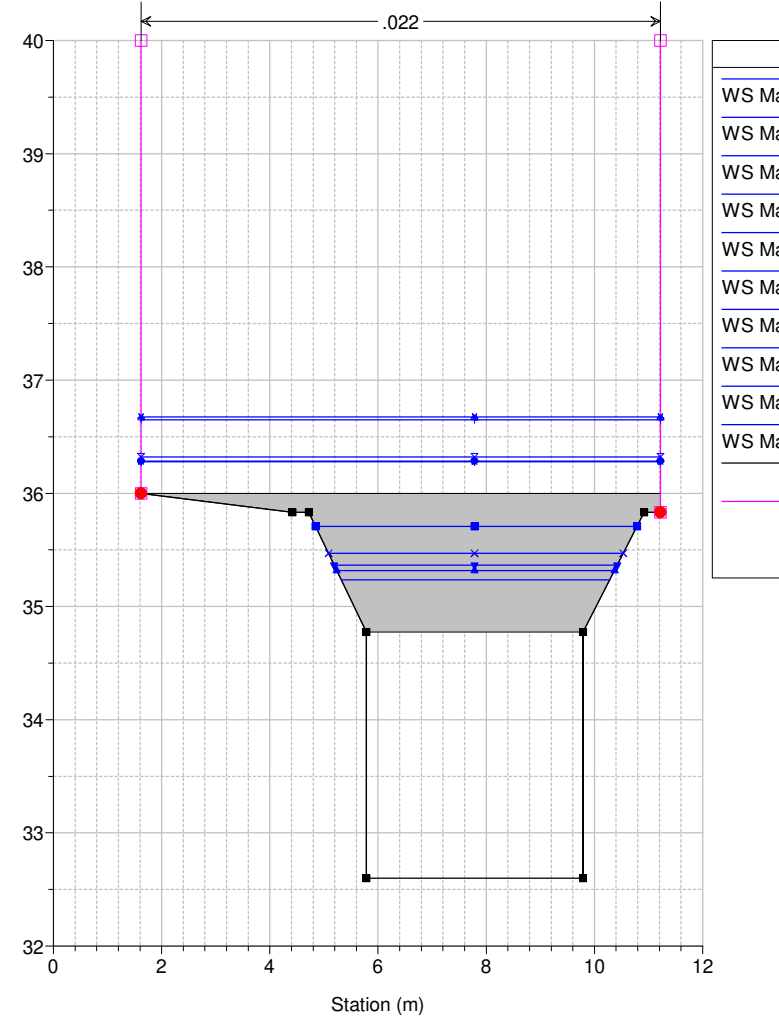

Legend	
WS Max WS - TR200_24_0	▲
WS Max WS - TR200_18_0	▲
WS Max WS - TR200_12_0	▲
WS Max WS - TR200_09_0	▲
WS Max WS - TR200_36_0	▲
WS Max WS - TR200_06_0	▲
WS Max WS - TR200_03_0	▲
WS Max WS - TR200_01_5	▲
WS Max WS - TR200_01_0	▲
WS Max WS - TR200_00_5	▲
Ground	■
Levee	□
Bank Sta	●

Studio Scandicci Torrenti Greve-Vingone
River = Fosso Rigone Reach = Rigone 01 RS = 7.5 BR

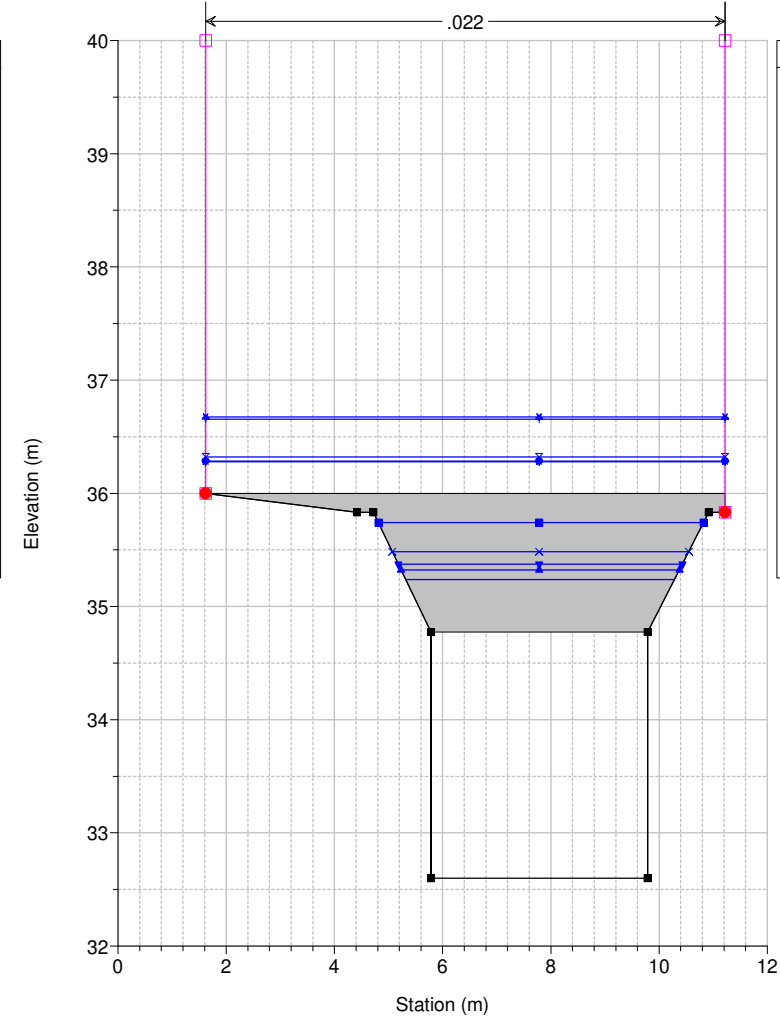

Legend	
WS Max WS - TR200_24_0	▲
WS Max WS - TR200_18_0	▲
WS Max WS - TR200_12_0	▲
WS Max WS - TR200_09_0	▲
WS Max WS - TR200_36_0	▲
WS Max WS - TR200_06_0	▲
WS Max WS - TR200_03_0	▲
WS Max WS - TR200_01_5	▲
WS Max WS - TR200_01_0	▲
WS Max WS - TR200_00_5	▲
Ground	■
Levee	□
Bank Sta	●

Studio Scandicci Torrenti Greve-Vingone
River = Fosso Rigone Reach = Rigone 01 RS = 7 DO1033_C

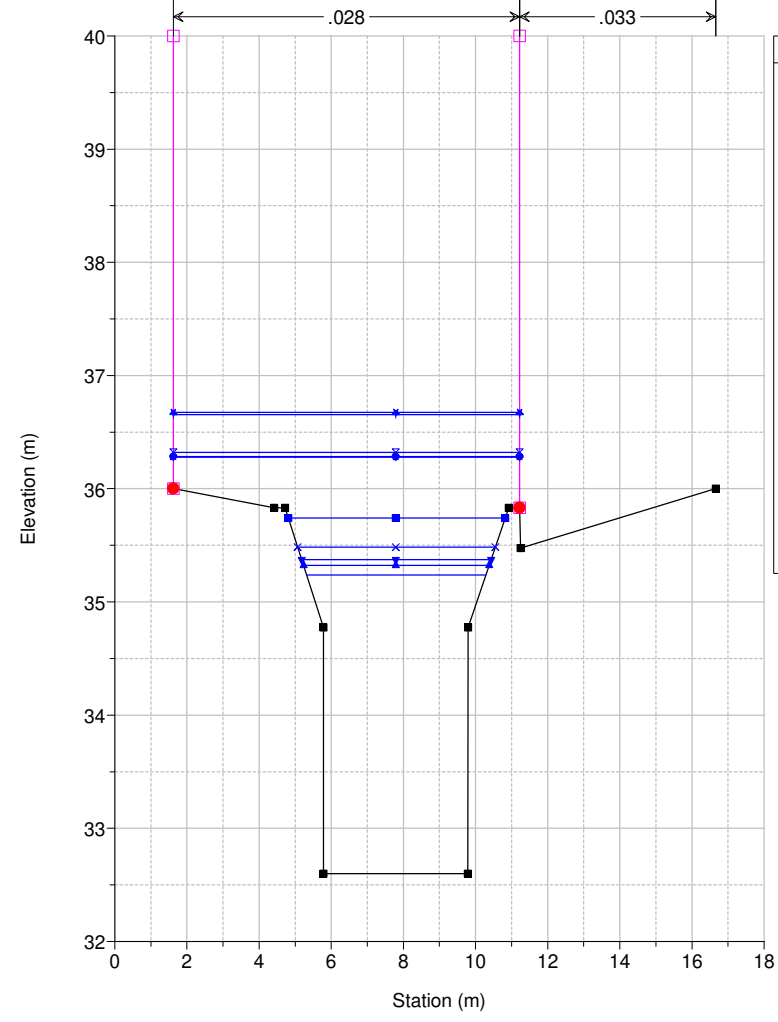

Legend	
WS Max WS - TR200_24_0	▲
WS Max WS - TR200_18_0	▲
WS Max WS - TR200_12_0	▲
WS Max WS - TR200_09_0	▲
WS Max WS - TR200_36_0	▲
WS Max WS - TR200_06_0	▲
WS Max WS - TR200_03_0	▲
WS Max WS - TR200_01_5	▲
WS Max WS - TR200_01_0	▲
WS Max WS - TR200_00_5	▲
Ground	■
Levee	□
Bank Sta	●

Studio Scandicci Torrenti Greve-Vingone
River = Fosso Rigone Reach = Rigone 01 RS = 6 DO1033_D

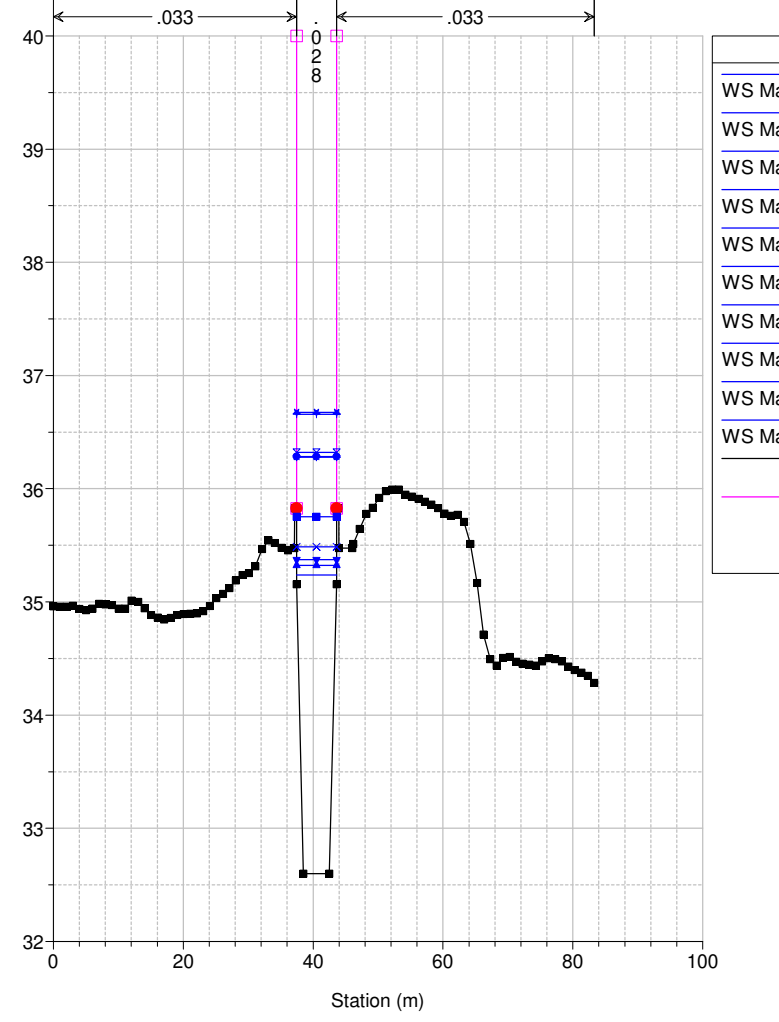

Legend	
WS Max WS - TR200_24_0	▲
WS Max WS - TR200_18_0	▲
WS Max WS - TR200_12_0	▲
WS Max WS - TR200_09_0	▲
WS Max WS - TR200_36_0	▲
WS Max WS - TR200_06_0	▲
WS Max WS - TR200_03_0	▲
WS Max WS - TR200_01_5	▲
WS Max WS - TR200_01_0	▲
WS Max WS - TR200_00_5	▲
Ground	■
Levee	□
Bank Sta	●

Studio Scandicci Torrenti Greve-Vingone
River = Fosso Rigone Reach = Rigone 01 RS = 5 DO1034_A

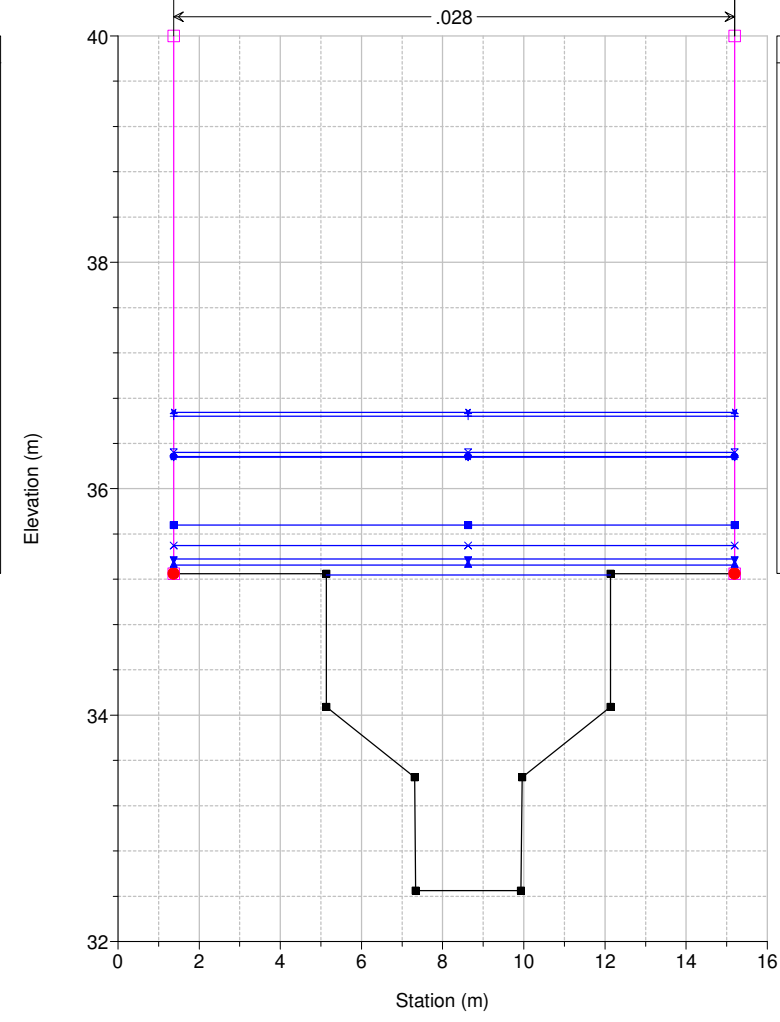

Legend	
WS Max WS - TR200_24_0	▲
WS Max WS - TR200_18_0	▲
WS Max WS - TR200_12_0	▲
WS Max WS - TR200_09_0	▲
WS Max WS - TR200_36_0	▲
WS Max WS - TR200_06_0	▲
WS Max WS - TR200_03_0	▲
WS Max WS - TR200_01_5	▲
WS Max WS - TR200_01_0	▲
WS Max WS - TR200_00_5	▲
Ground	■
Levee	□
Bank Sta	●

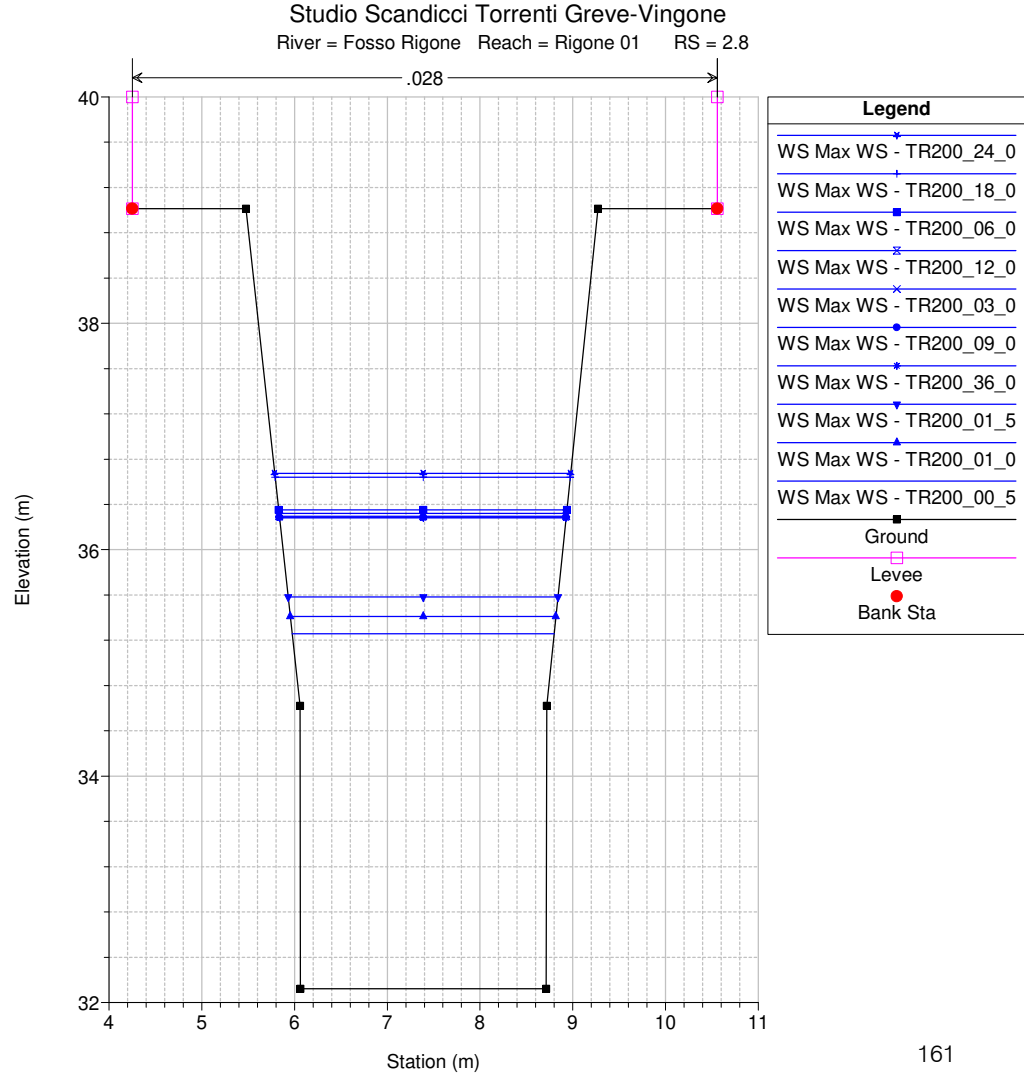
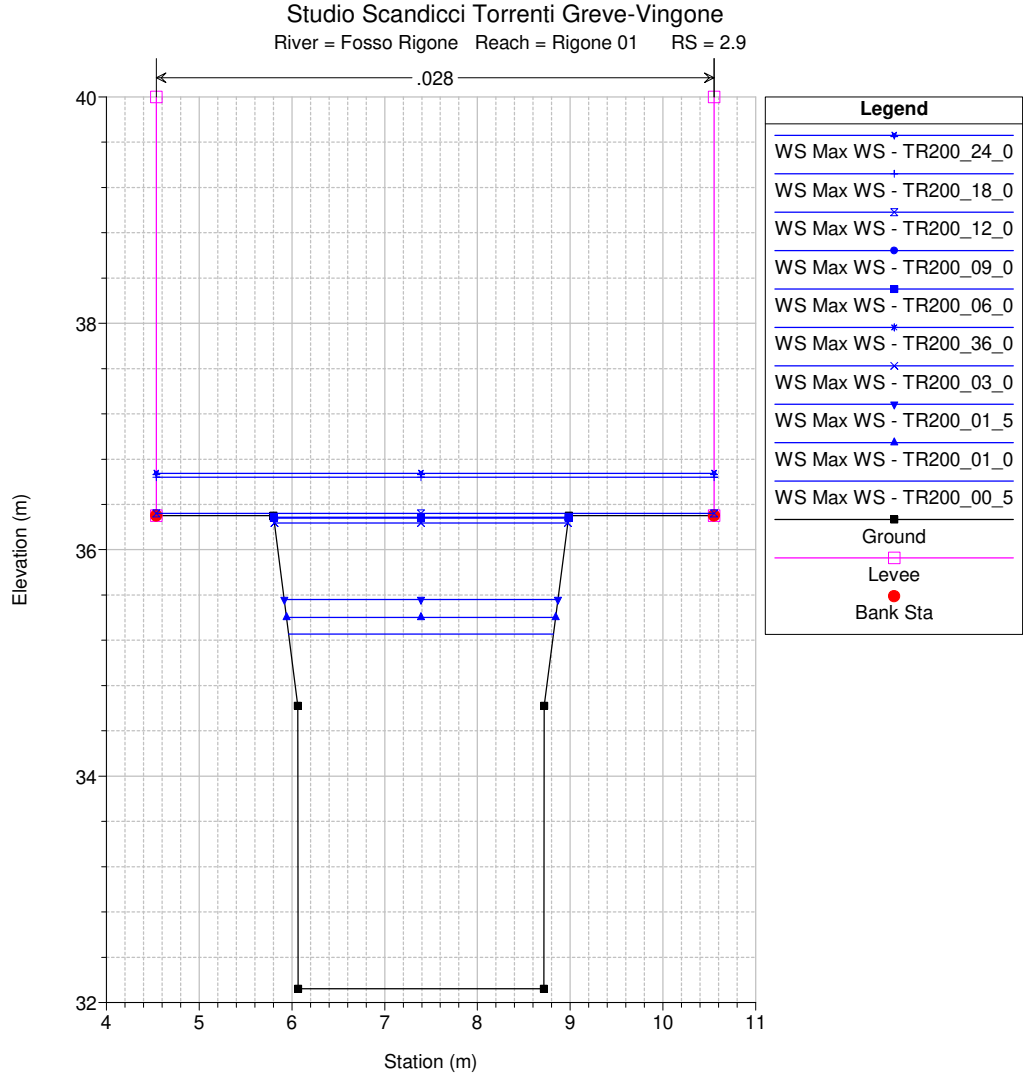
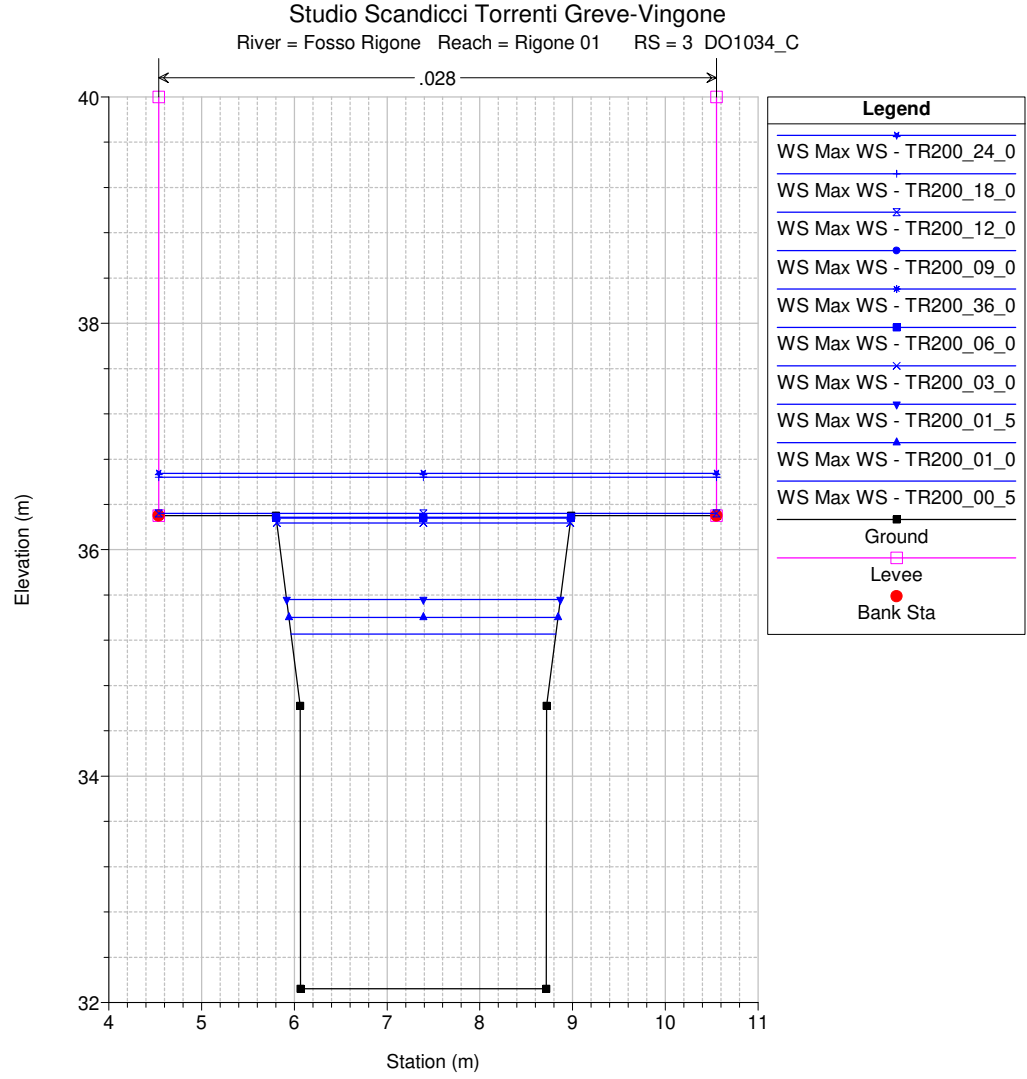
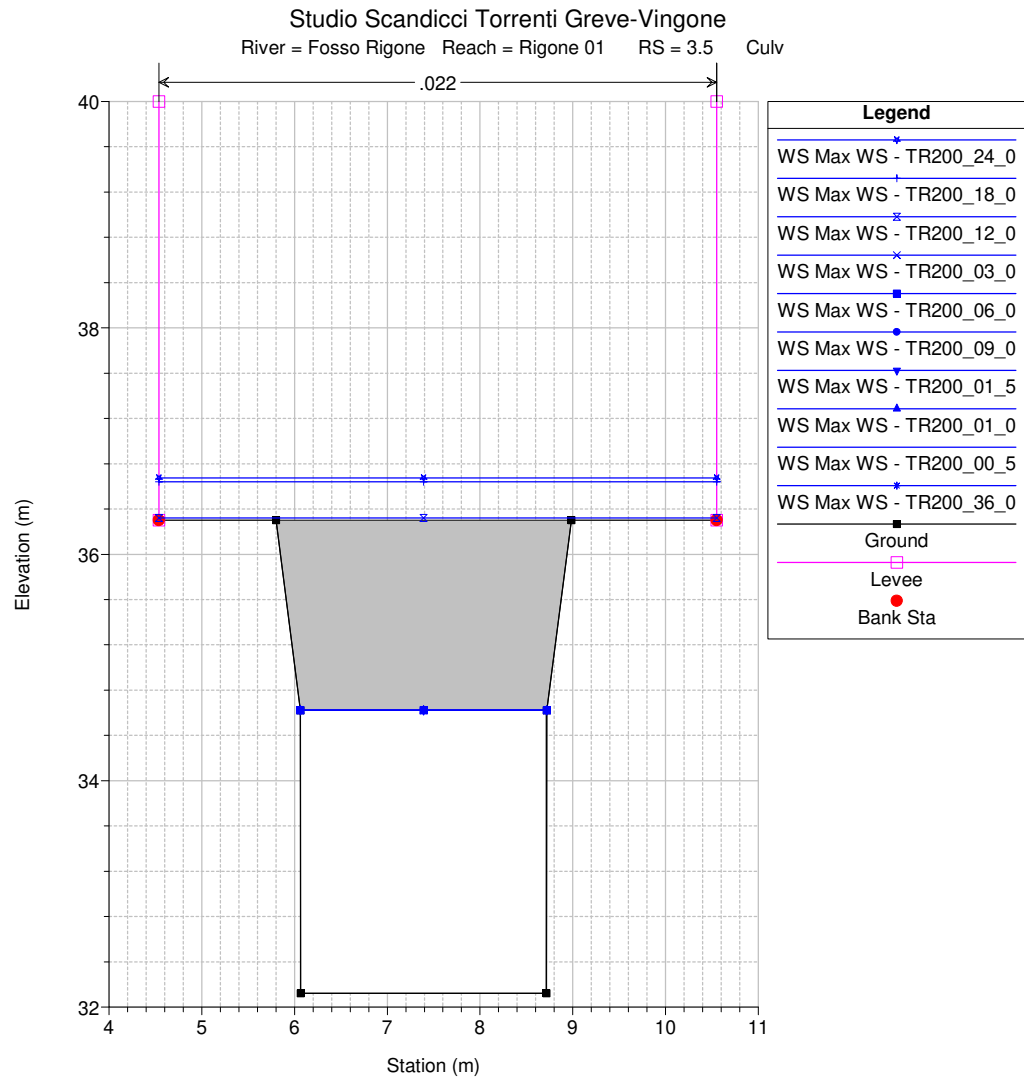
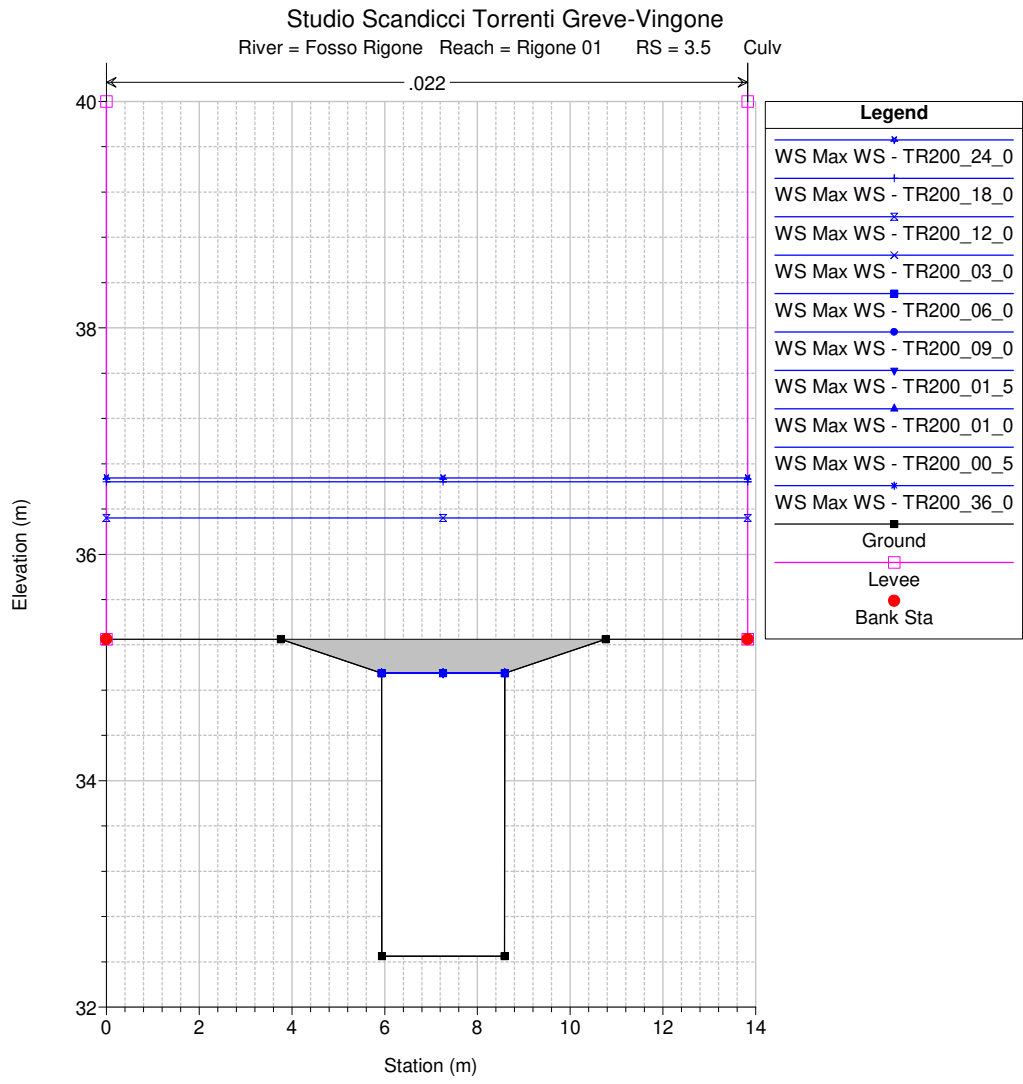
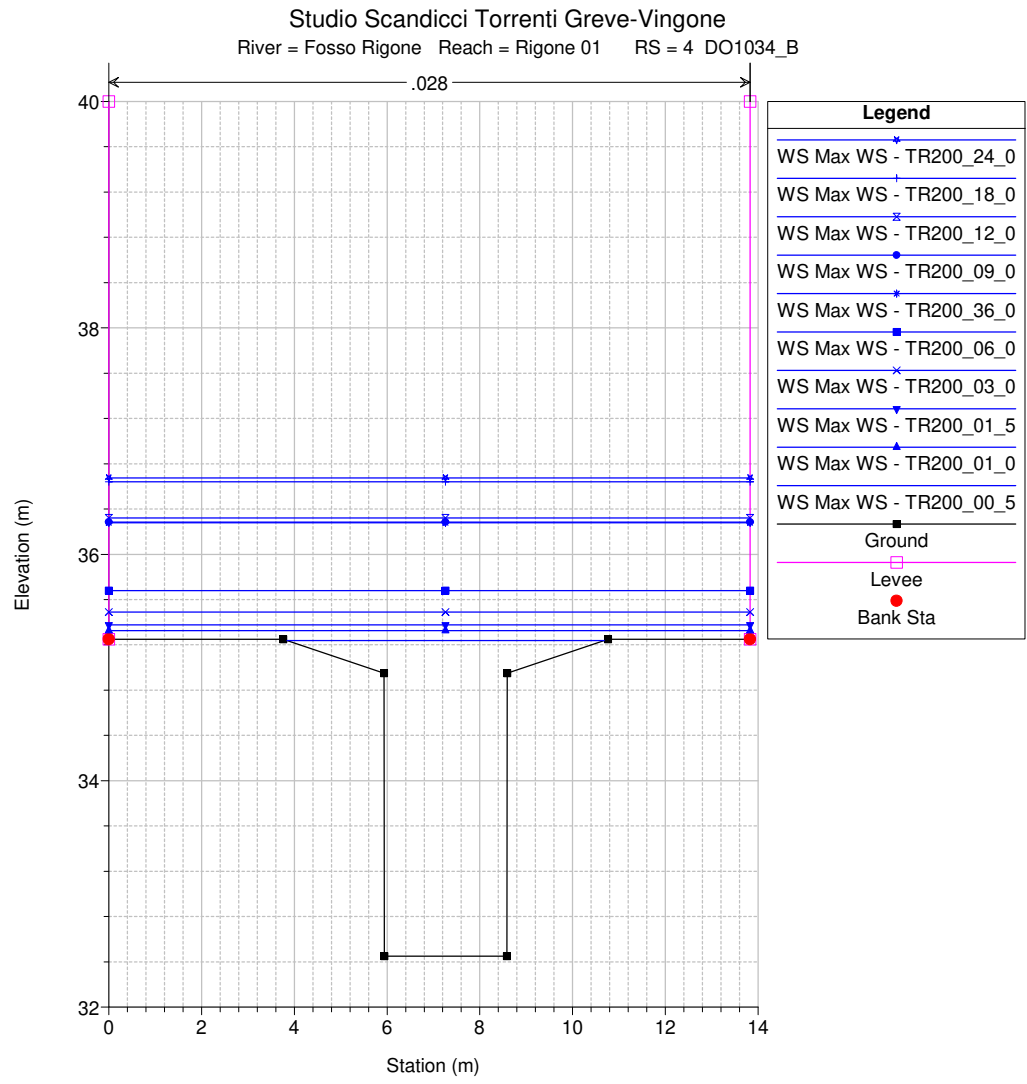

Studio Scandicci Torrenti Greve-Vingone
River = Fosso Rigone Reach = Rigone 01 RS = 2 DO1034_D

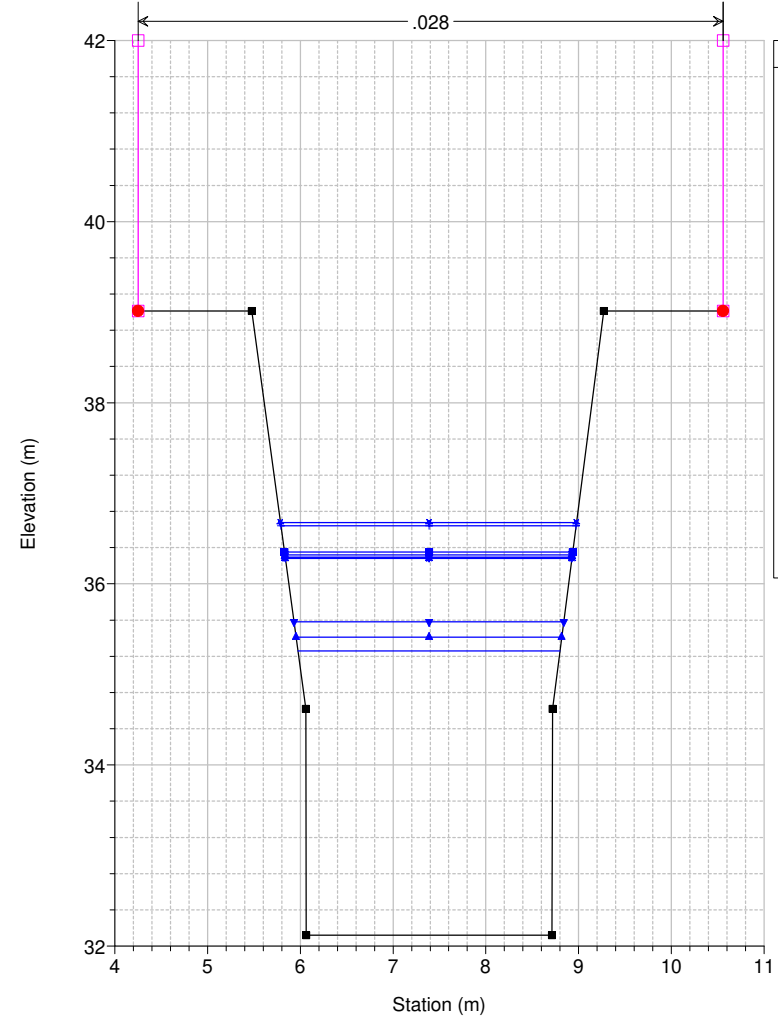

- Legend**
- WS Max WS - TR200_24_0
 - WS Max WS - TR200_18_0
 - WS Max WS - TR200_06_0
 - WS Max WS - TR200_12_0
 - WS Max WS - TR200_03_0
 - WS Max WS - TR200_09_0
 - WS Max WS - TR200_36_0
 - WS Max WS - TR200_01_5
 - WS Max WS - TR200_01_0
 - WS Max WS - TR200_00_5
 - Ground
 - Levee
 - Bank Sta

Studio Scandicci Torrenti Greve-Vingone
River = Fosso Rigone Reach = Rigone 01 RS = 1.75 IS

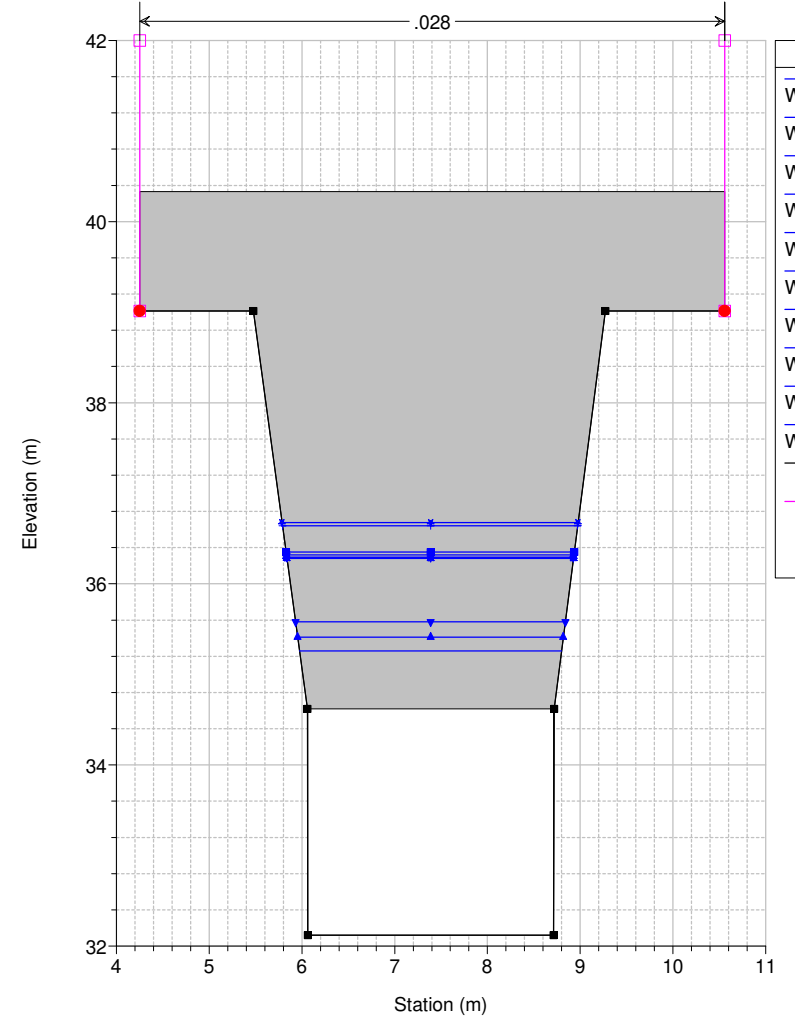

- Legend**
- WS Max WS - TR200_24_0
 - WS Max WS - TR200_18_0
 - WS Max WS - TR200_06_0
 - WS Max WS - TR200_12_0
 - WS Max WS - TR200_03_0
 - WS Max WS - TR200_09_0
 - WS Max WS - TR200_36_0
 - WS Max WS - TR200_01_5
 - WS Max WS - TR200_01_0
 - WS Max WS - TR200_00_5
 - Ground
 - Levee
 - Bank Sta

Studio Scandicci Torrenti Greve-Vingone
River = Fosso Rigone Reach = Rigone 01 RS = 1.4

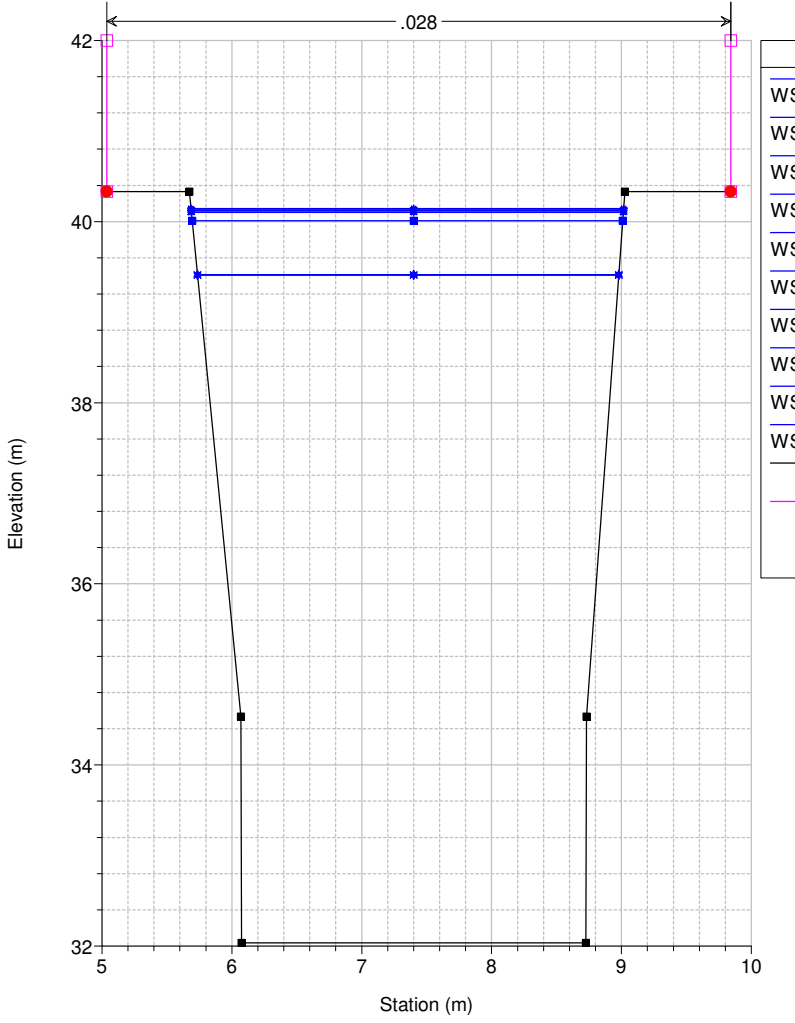

- Legend**
- WS Max WS - TR200_18_0
 - WS Max WS - TR200_24_0
 - WS Max WS - TR200_09_0
 - WS Max WS - TR200_12_0
 - WS Max WS - TR200_36_0
 - WS Max WS - TR200_06_0
 - WS Max WS - TR200_03_0
 - WS Max WS - TR200_00_5
 - WS Max WS - TR200_01_0
 - WS Max WS - TR200_01_5
 - Ground
 - Levee
 - Bank Sta

Studio Scandicci Torrenti Greve-Vingone
River = Fosso Rigone Reach = Rigone 01 RS = 1 DO1034_E

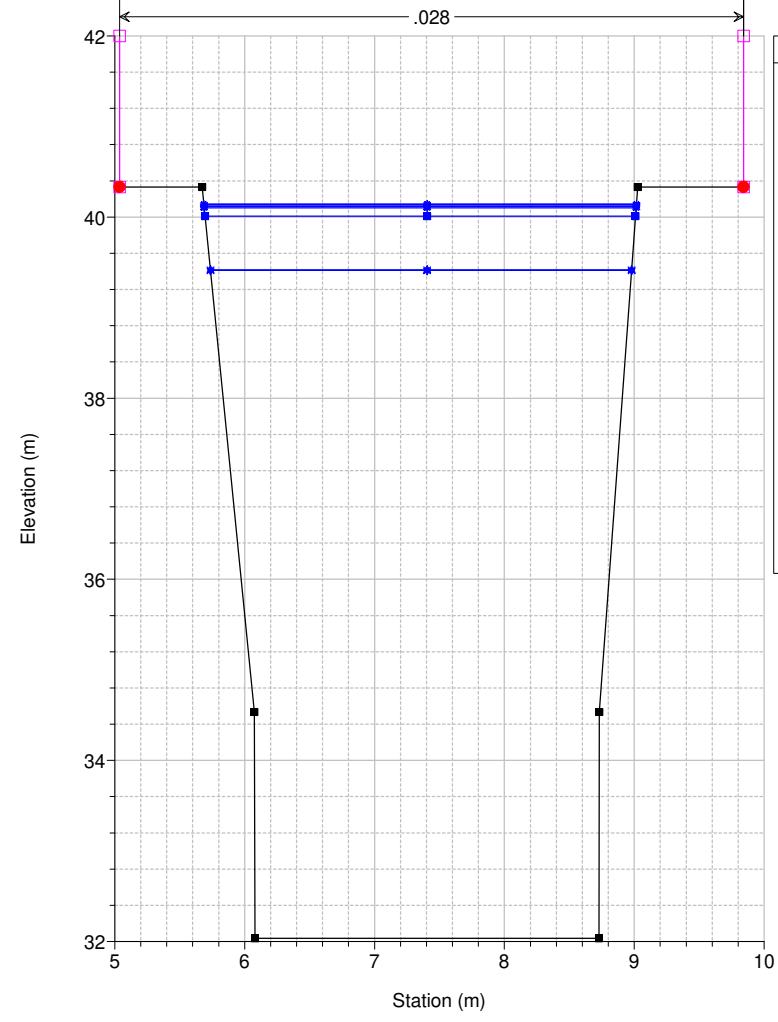

- Legend**
- WS Max WS - TR200_18_0
 - WS Max WS - TR200_24_0
 - WS Max WS - TR200_09_0
 - WS Max WS - TR200_12_0
 - WS Max WS - TR200_36_0
 - WS Max WS - TR200_06_0
 - WS Max WS - TR200_03_0
 - WS Max WS - TR200_00_5
 - WS Max WS - TR200_01_0
 - WS Max WS - TR200_01_5
 - Ground
 - Levee
 - Bank Sta

Studio Scandicci Torrenti Greve-Vingone
River = Fosso Rigone Reach = Rigone 01 RS = 0.5 AR0520

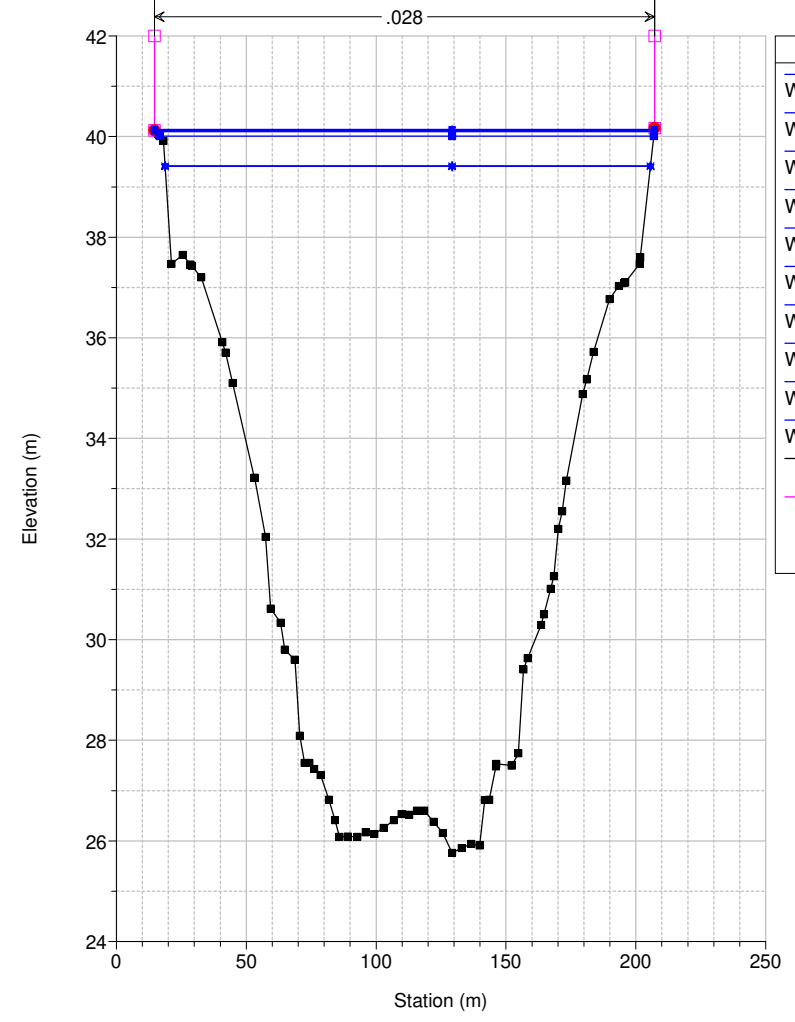

- Legend**
- WS Max WS - TR200_18_0
 - WS Max WS - TR200_24_0
 - WS Max WS - TR200_09_0
 - WS Max WS - TR200_12_0
 - WS Max WS - TR200_36_0
 - WS Max WS - TR200_06_0
 - WS Max WS - TR200_03_0
 - WS Max WS - TR200_00_5
 - WS Max WS - TR200_01_0
 - WS Max WS - TR200_01_5
 - Ground
 - Levee
 - Bank Sta

Studio Scandicci Torrenti Greve-Vingone
River = Fosso Stagnacci Reach = Stagnacci RS = 7 SR0004_

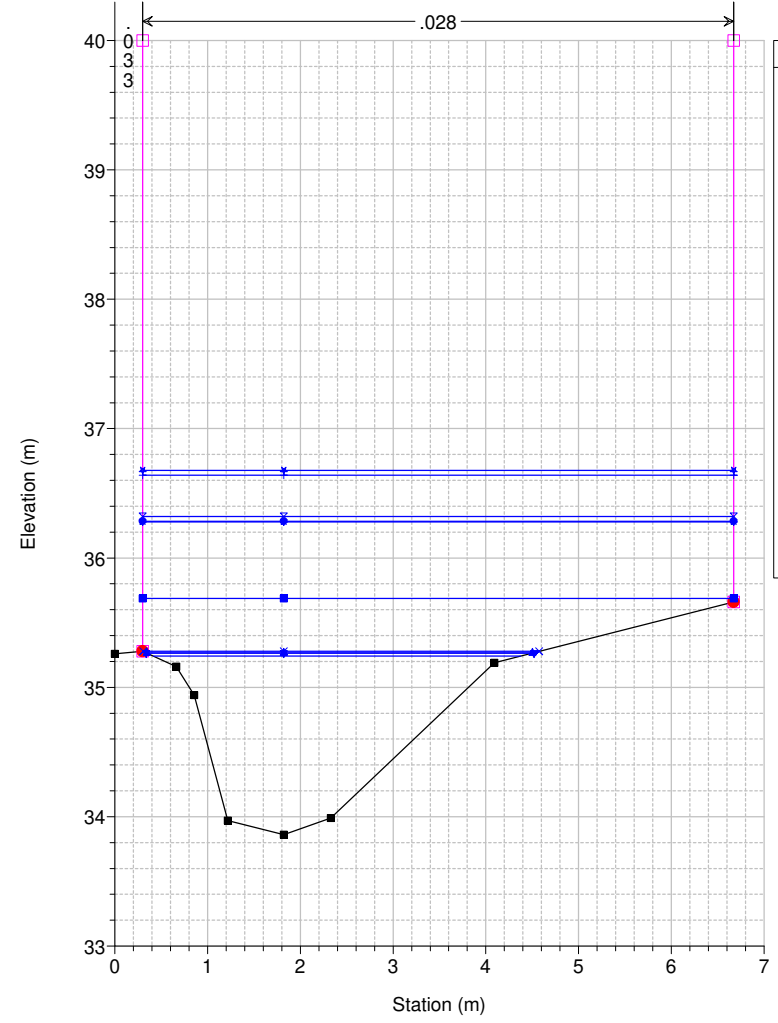

Studio Scandicci Torrenti Greve-Vingone
River = Fosso Stagnacci Reach = Stagnacci RS = 6 SR0003_A

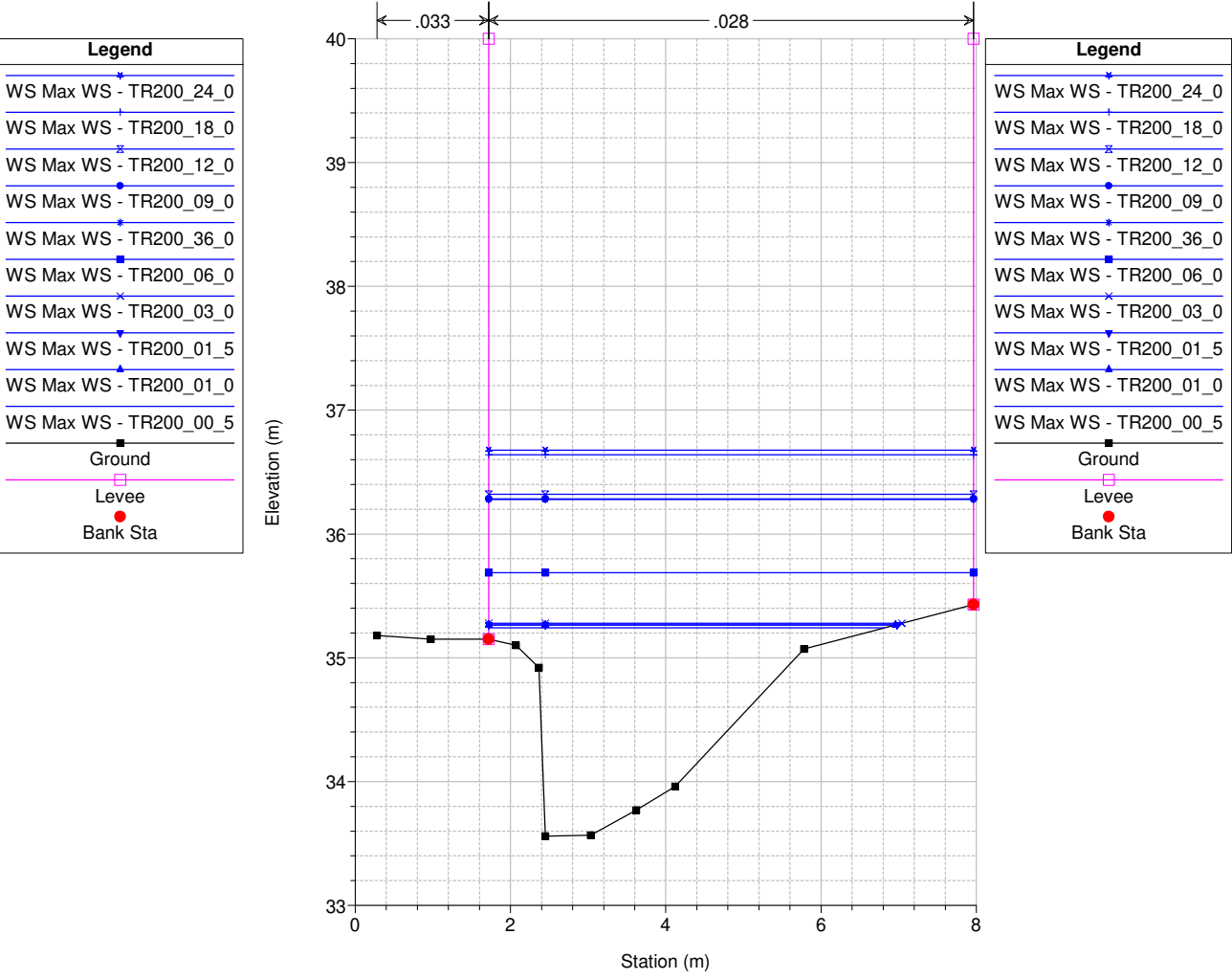

Studio Scandicci Torrenti Greve-Vingone
River = Fosso Stagnacci Reach = Stagnacci RS = 5 SR0003_B

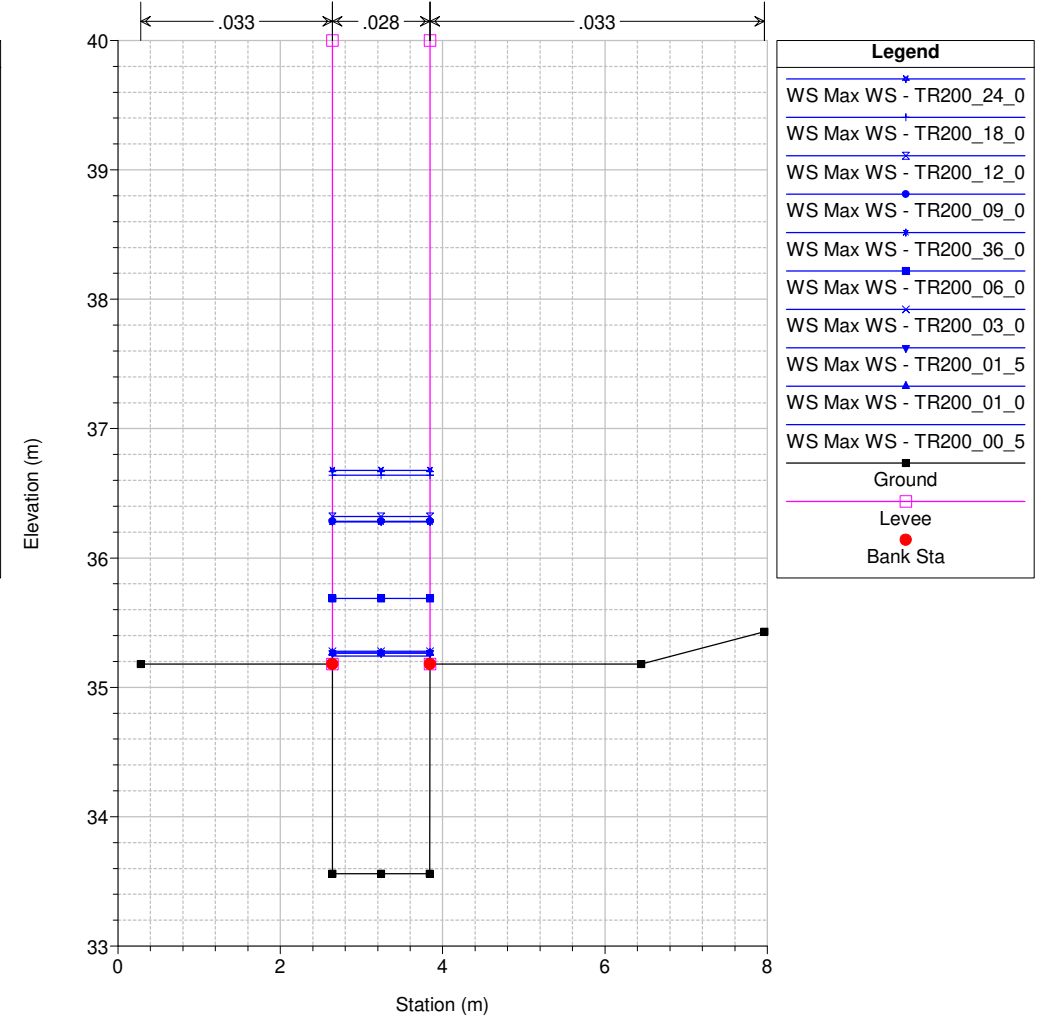

Studio Scandicci Torrenti Greve-Vingone
River = Fosso Stagnacci Reach = Stagnacci RS = 4.5 BR

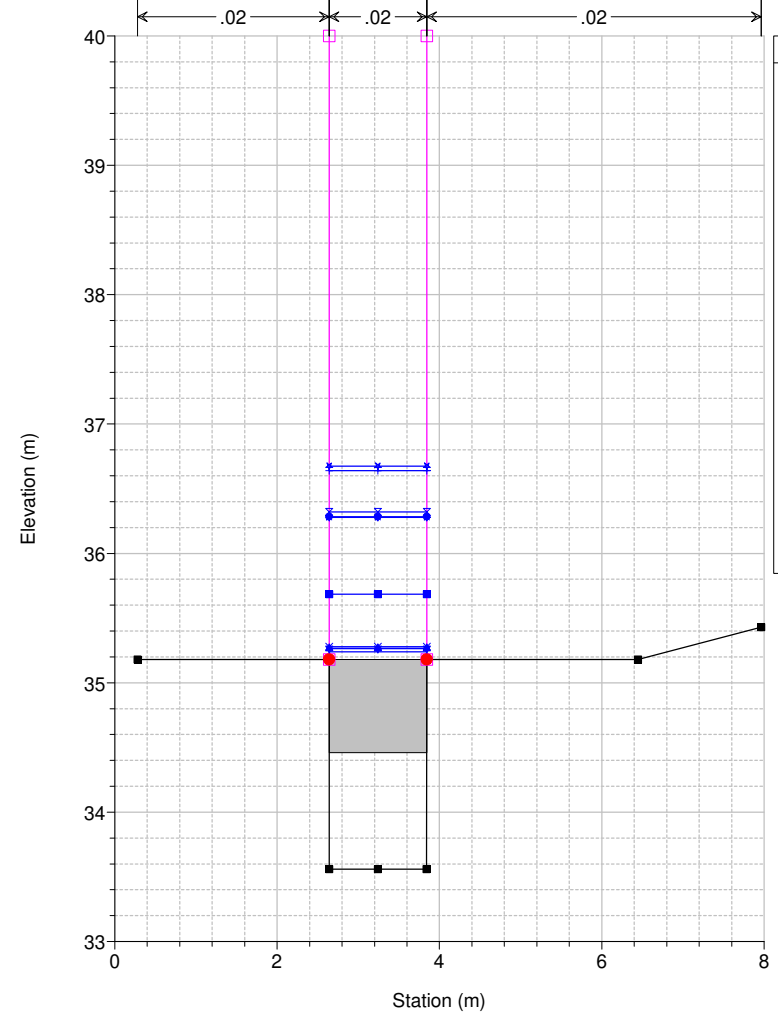

Studio Scandicci Torrenti Greve-Vingone
River = Fosso Stagnacci Reach = Stagnacci RS = 4.5 BR

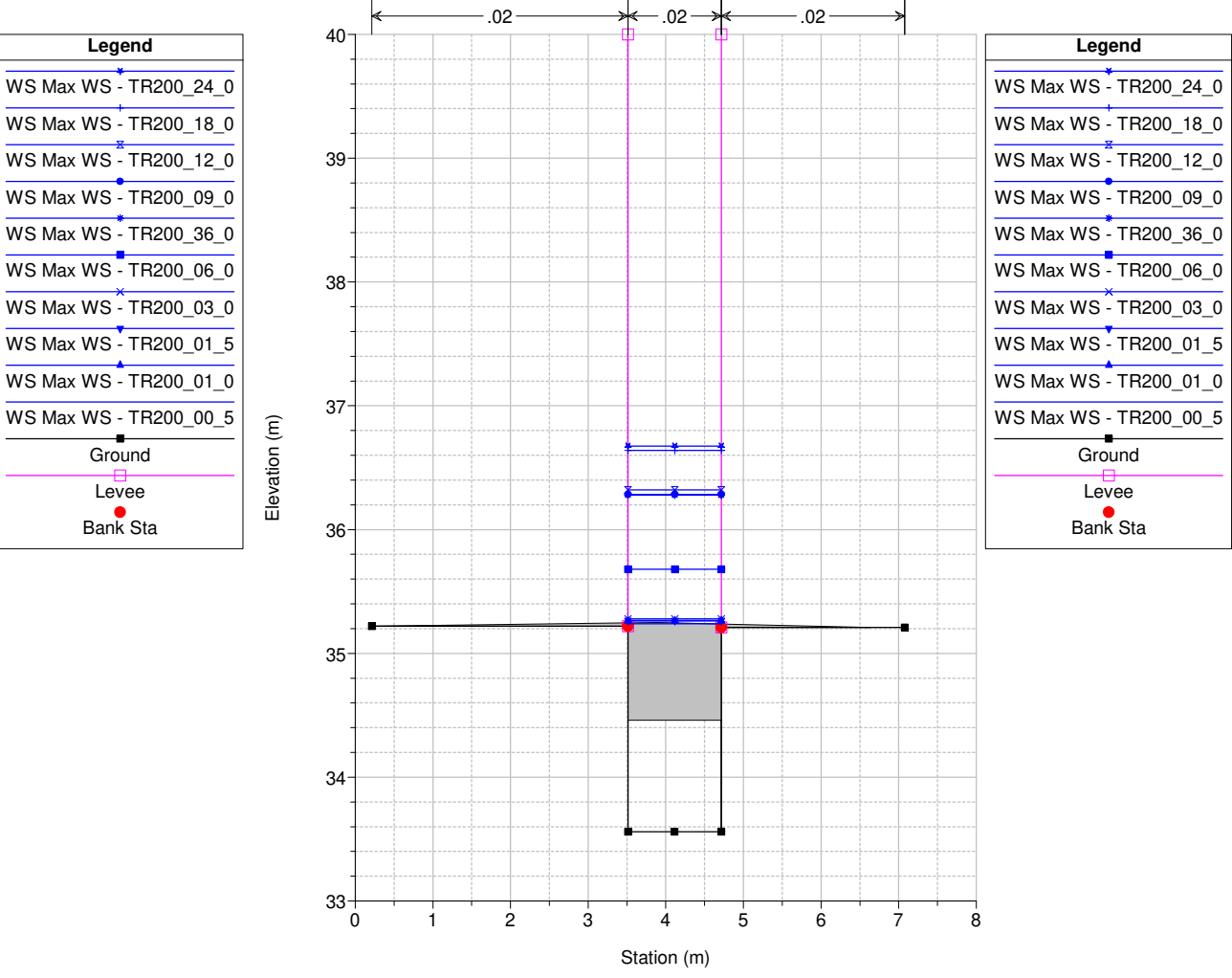

Studio Scandicci Torrenti Greve-Vingone
River = Fosso Stagnacci Reach = Stagnacci RS = 4 SR0003_C

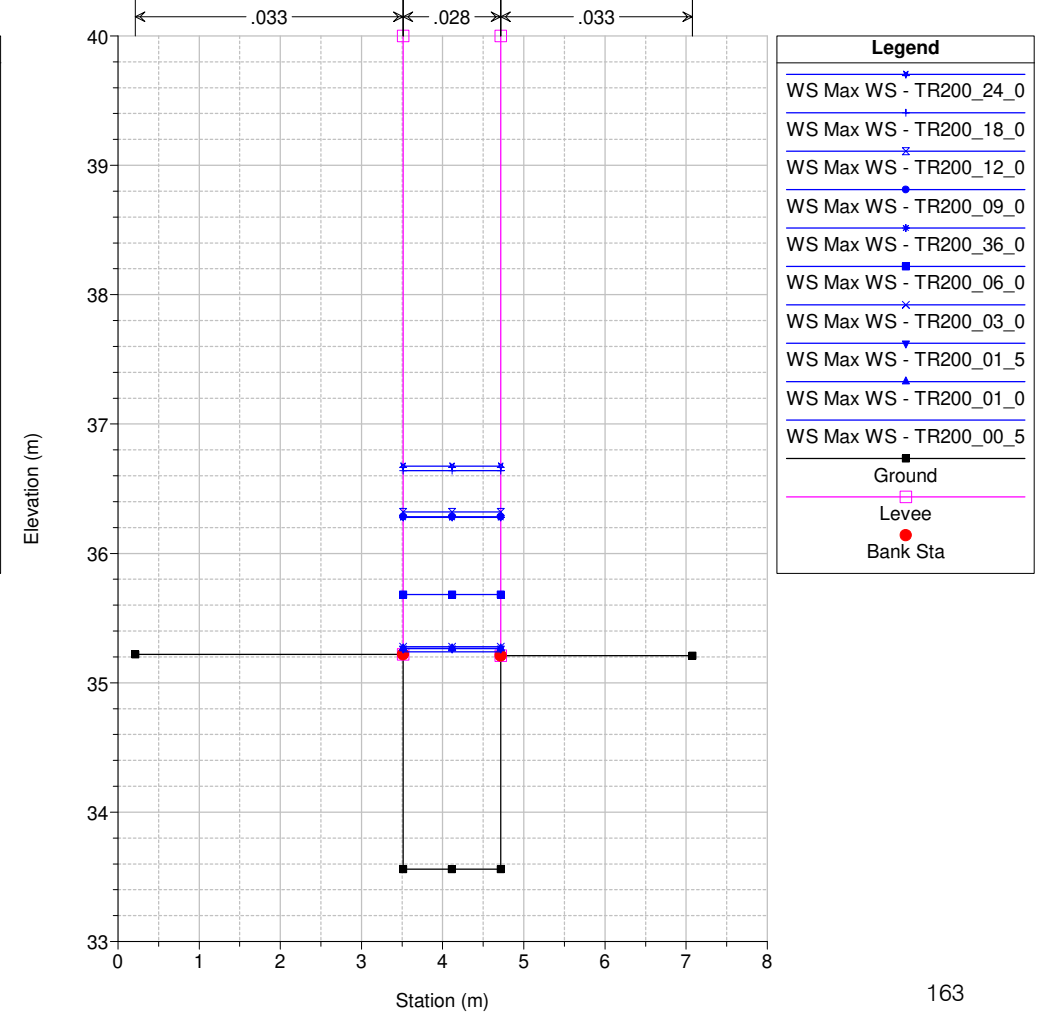

Studio Scandicci Torrenti Greve-Vingone

River = Fosso Stagnacci Reach = Stagnacci RS = 3 SR0003_D

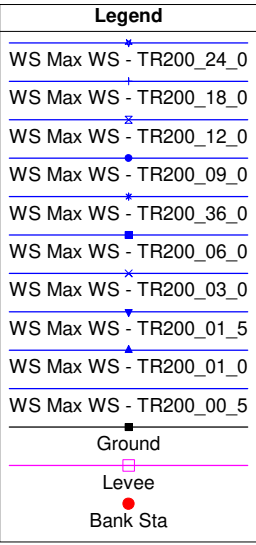
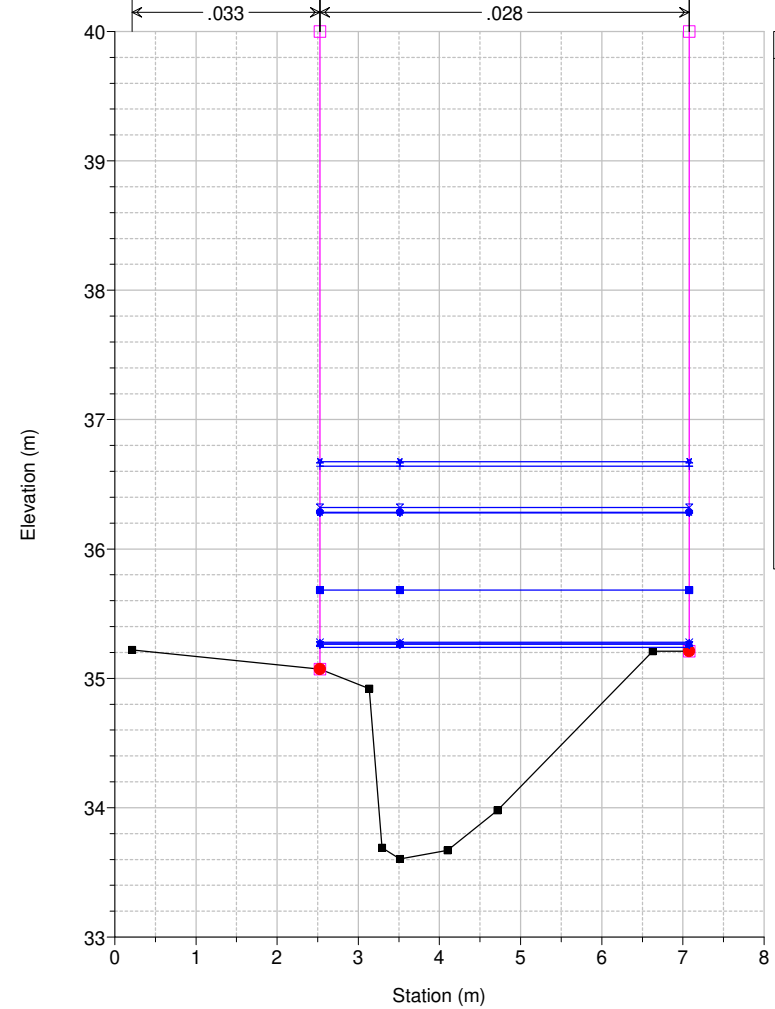

Studio Scandicci Torrenti Greve-Vingone

River = Fosso Stagnacci Reach = Stagnacci RS = 2 SR0002_

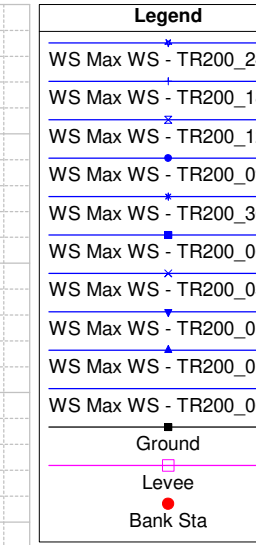
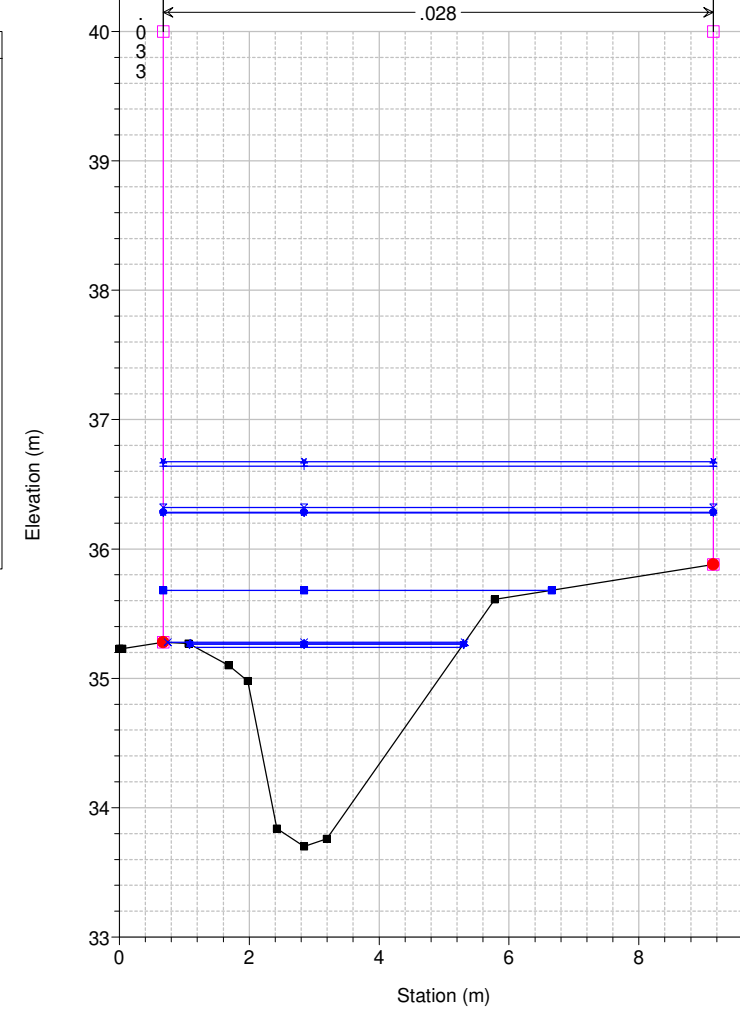

Studio Scandicci Torrenti Greve-Vingone

River = Fosso Stagnacci Reach = Stagnacci RS = 1 SR0001_

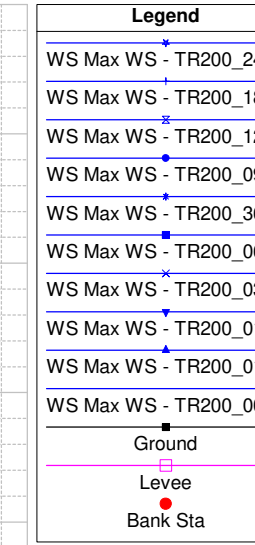
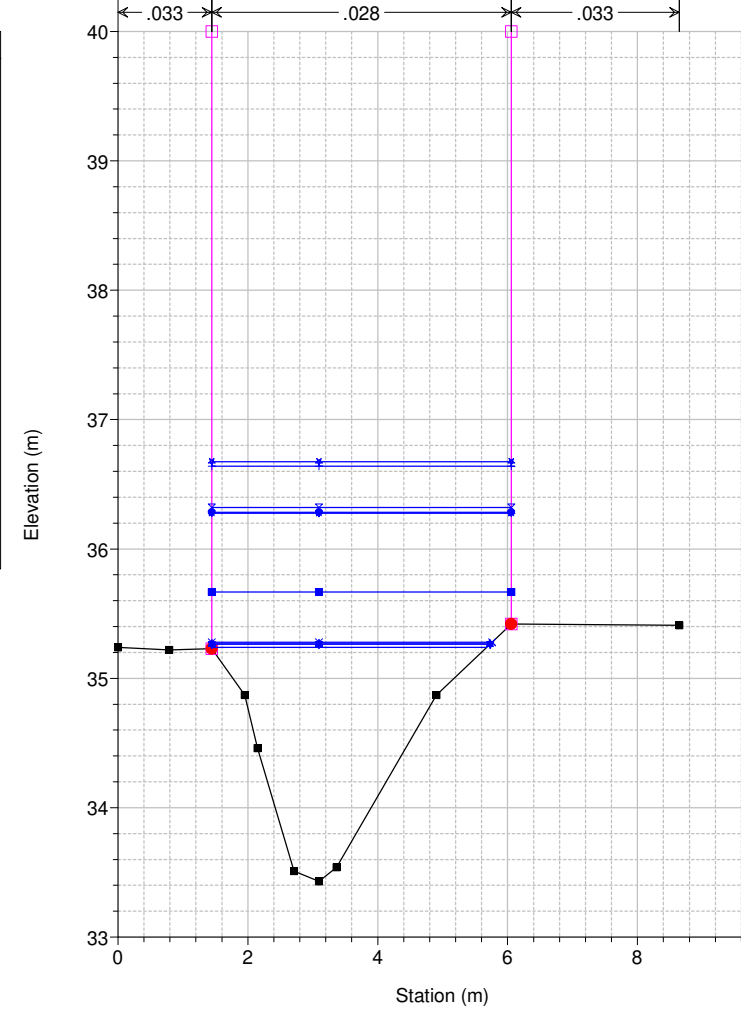

Studio Scandicci Torrenti Greve-Vingone

River = Fosso Stagnacci Reach = Stagnacci RS = 0.5

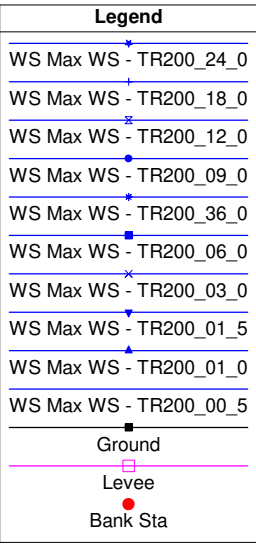
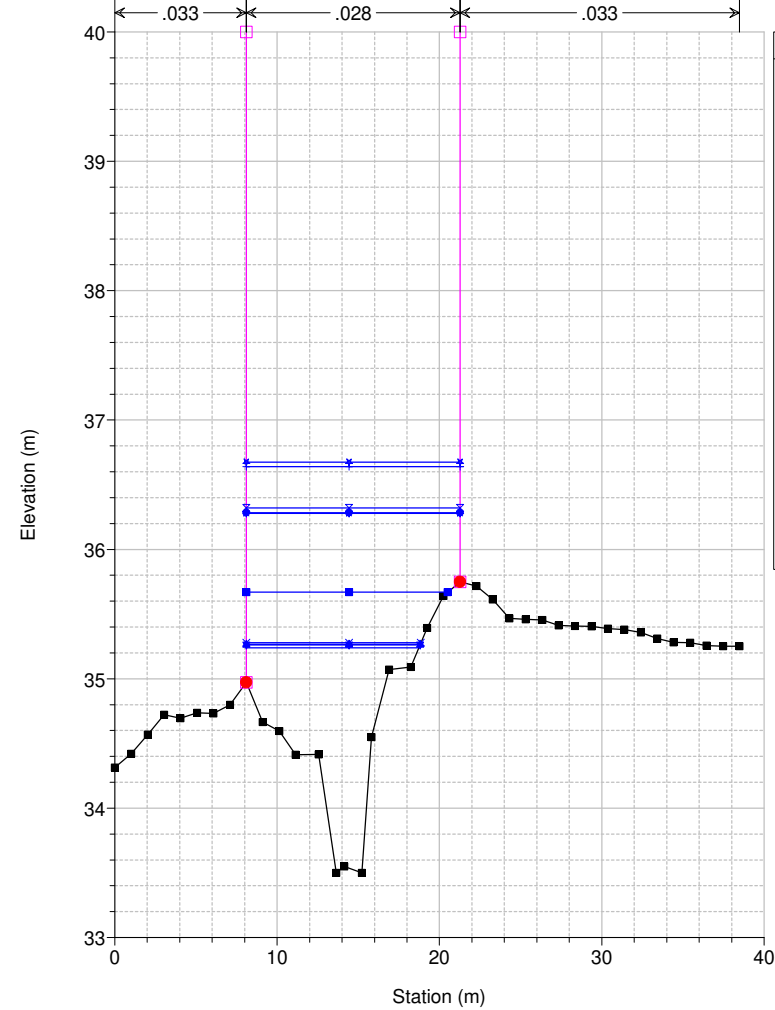

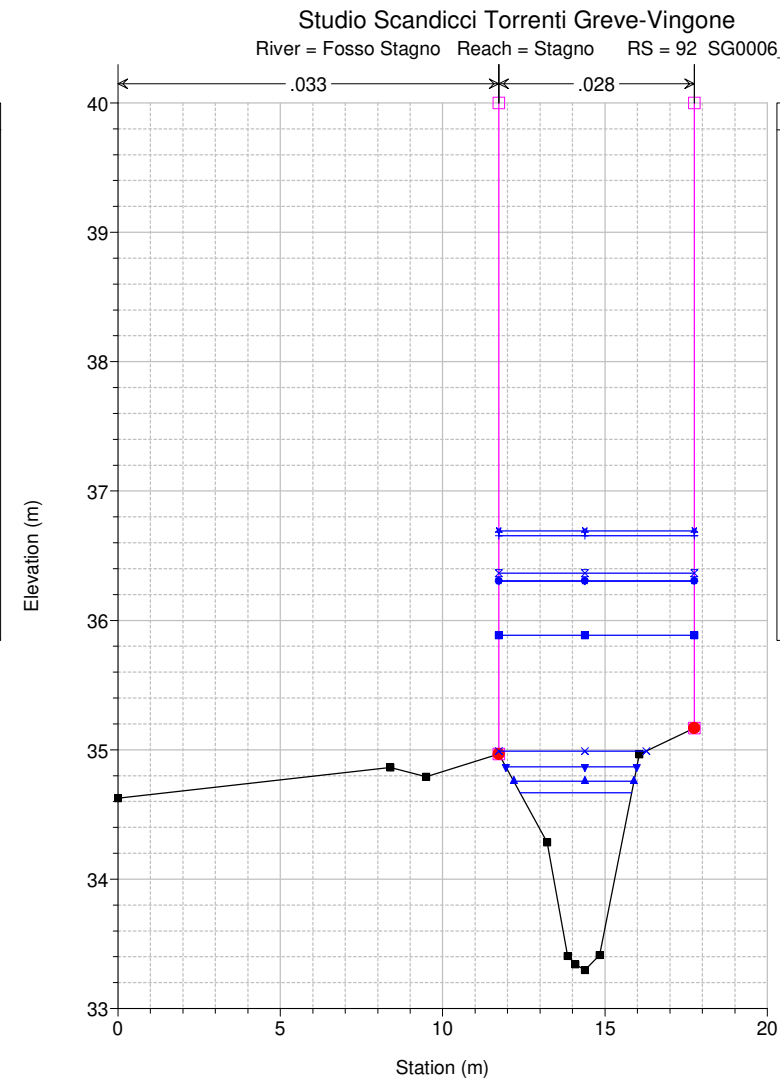
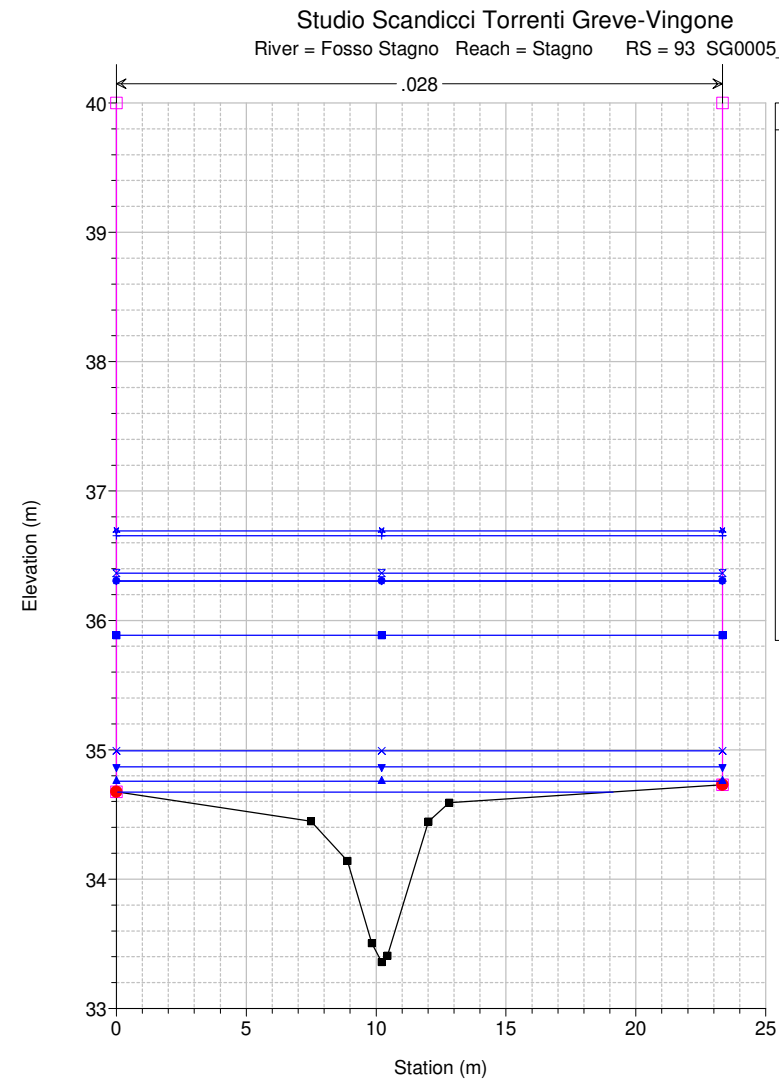
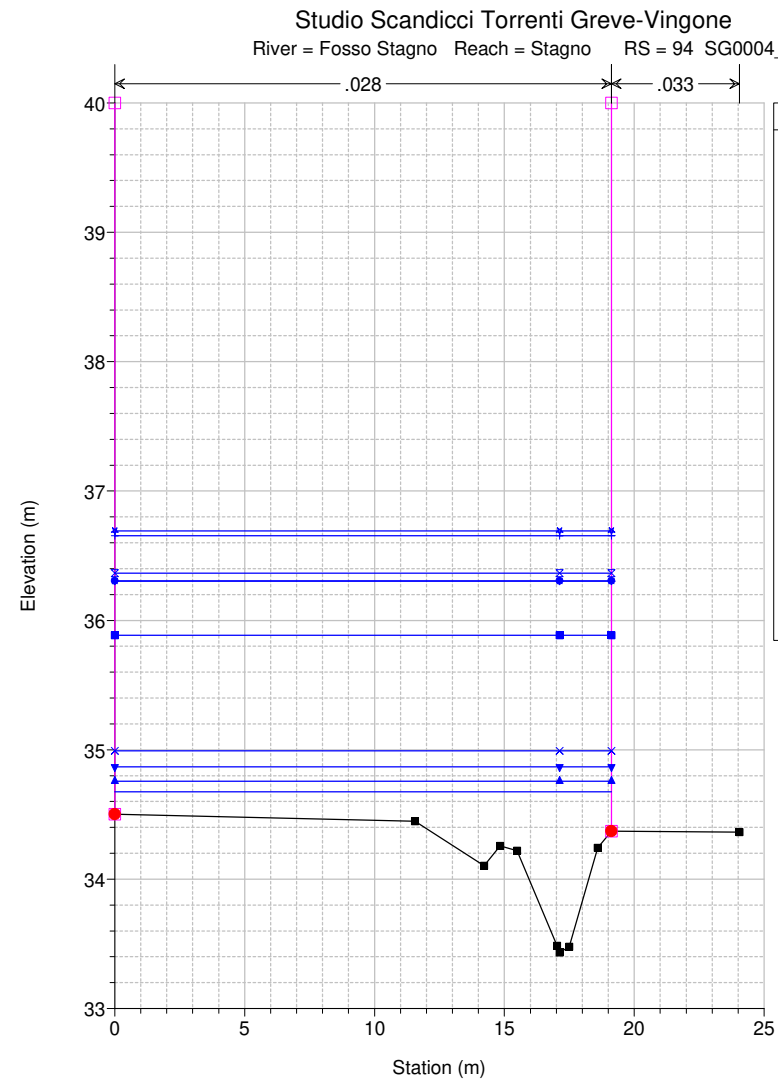
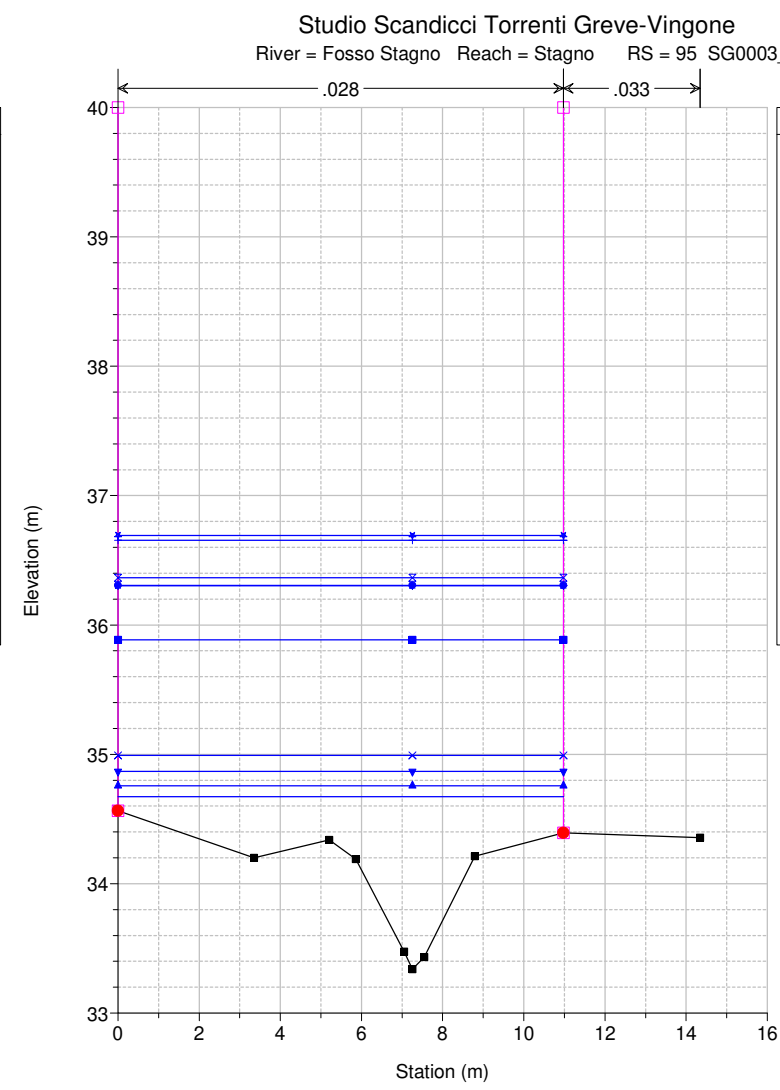
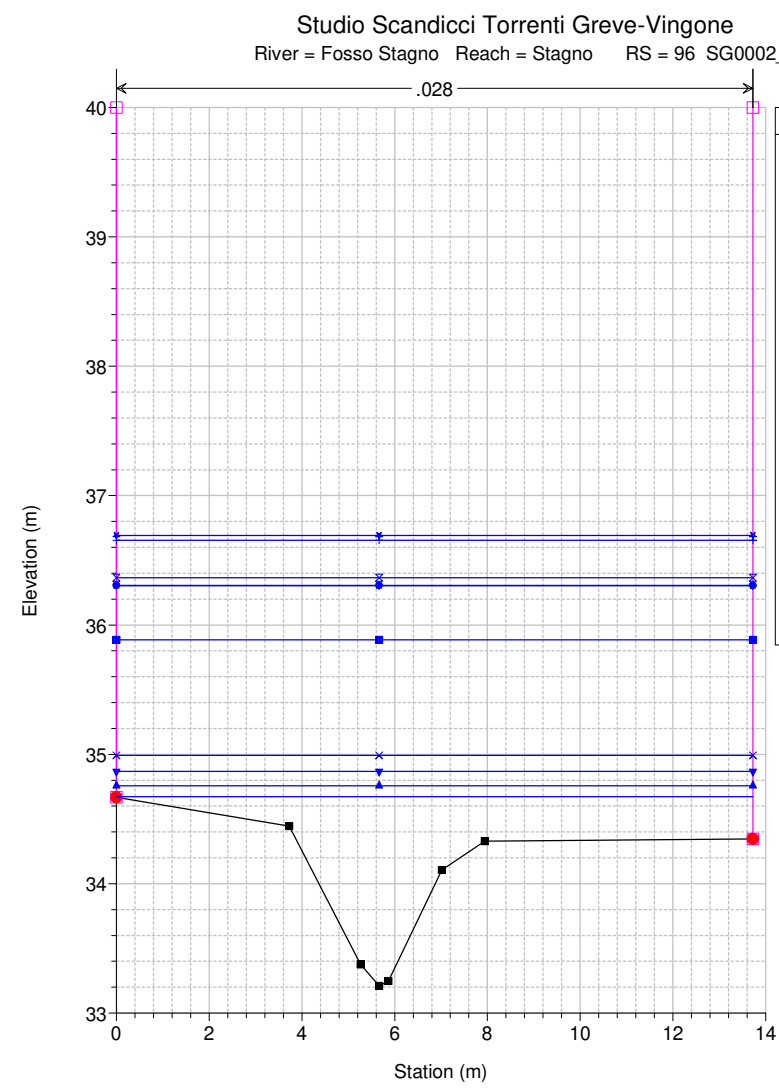
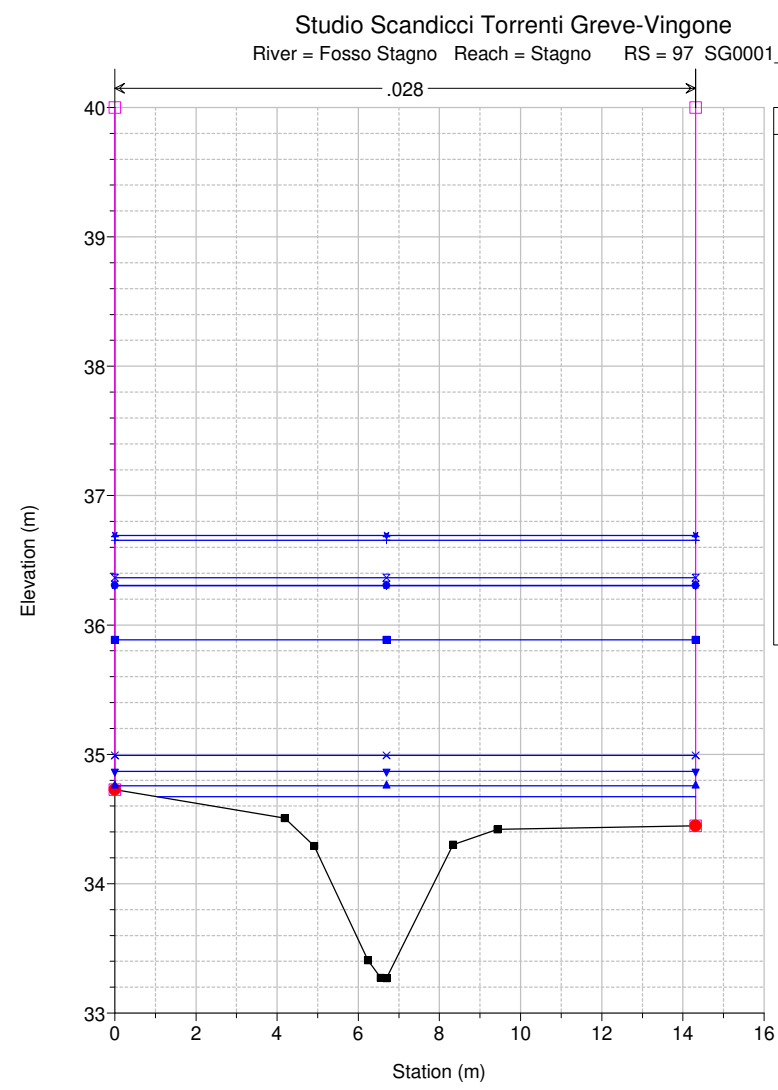

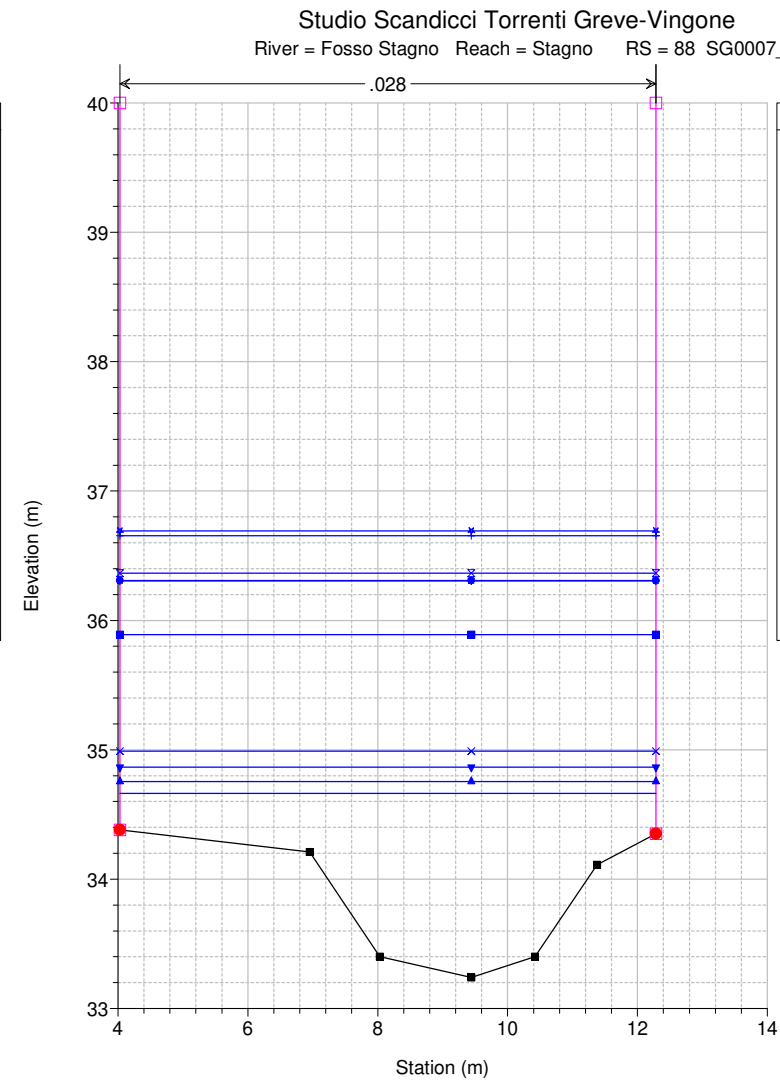
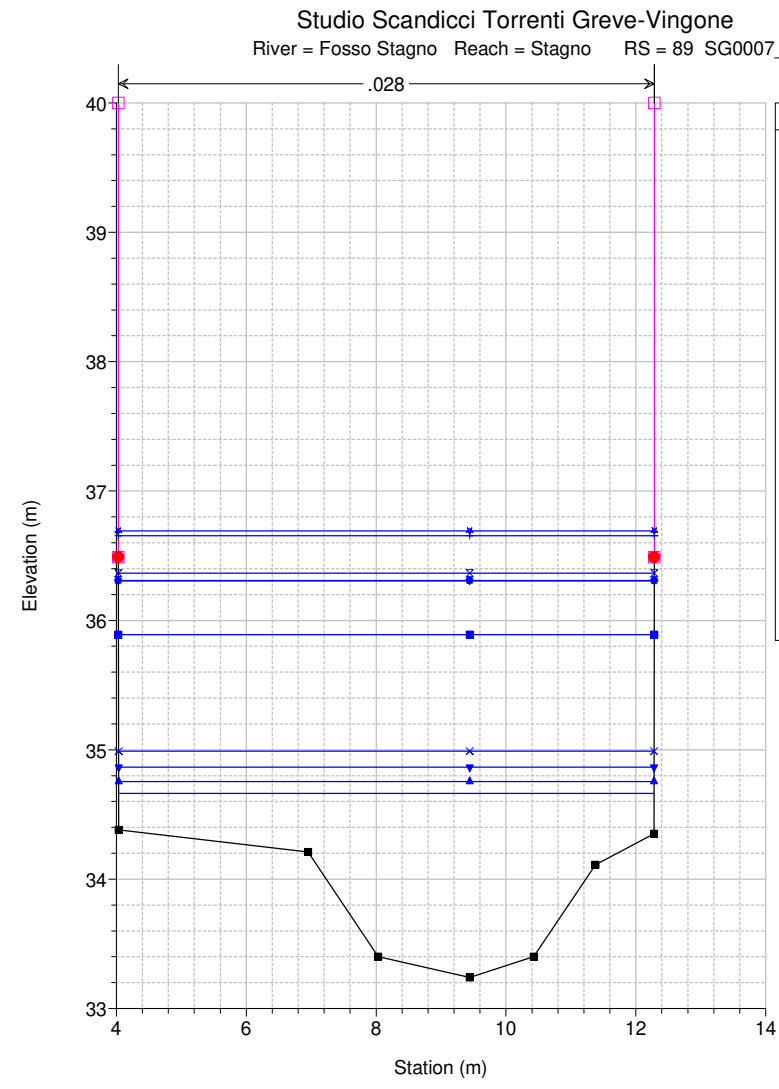
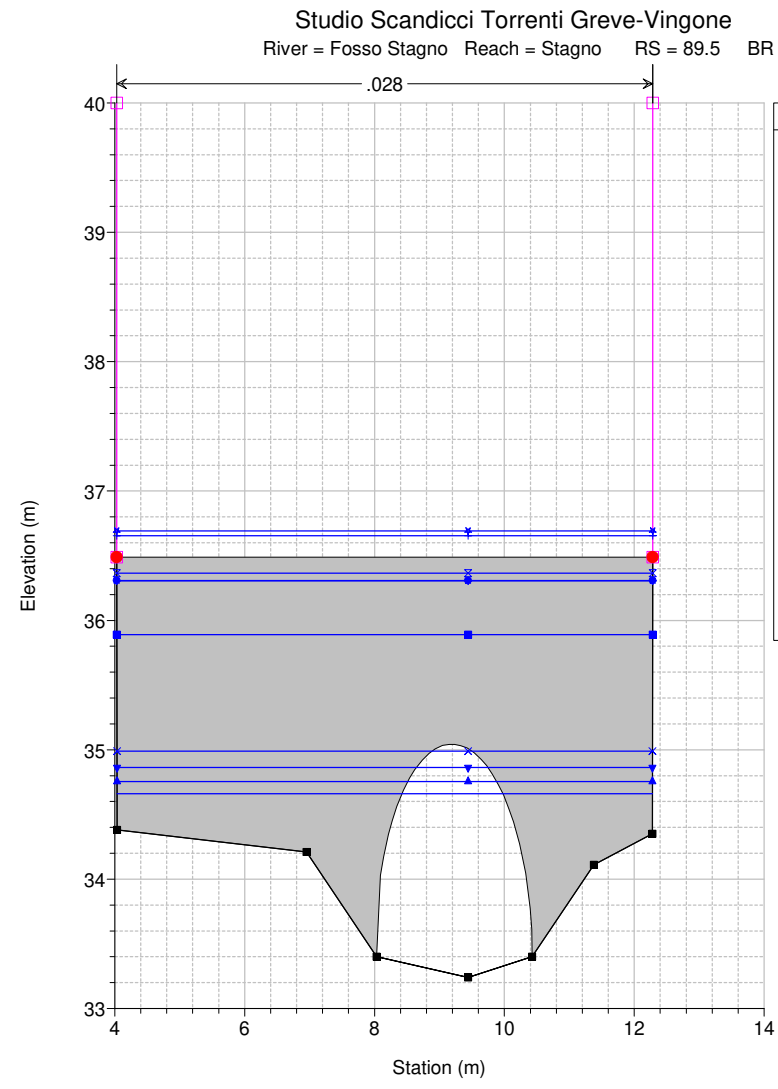
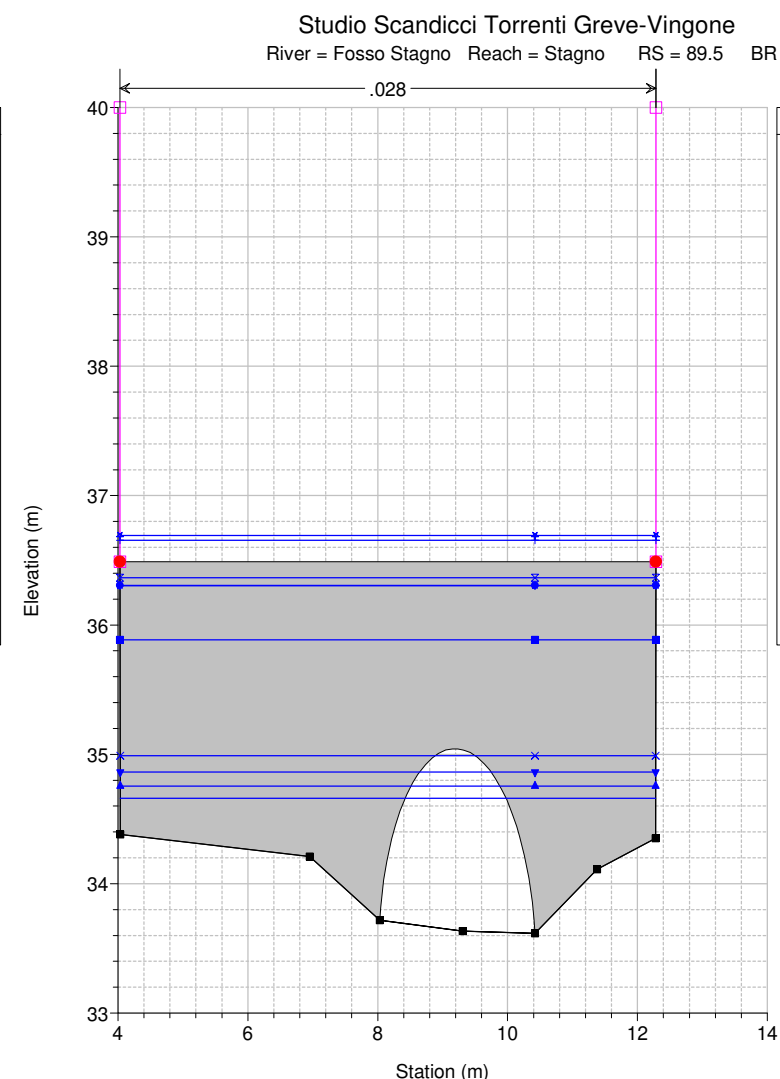
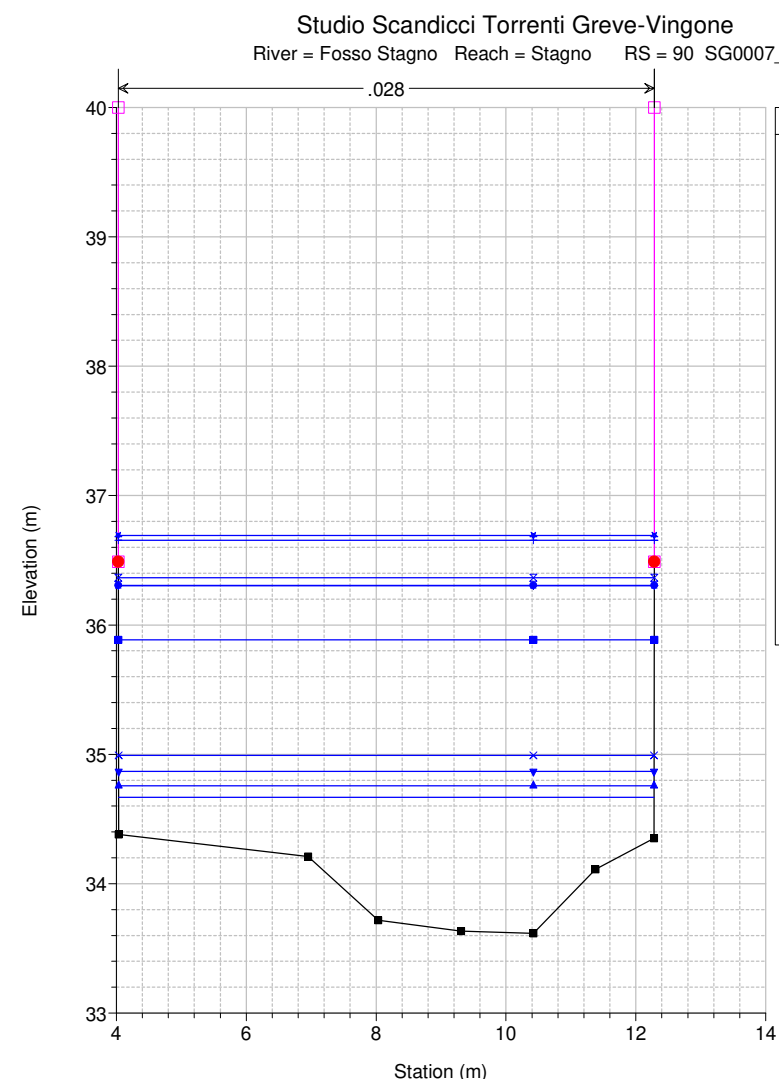
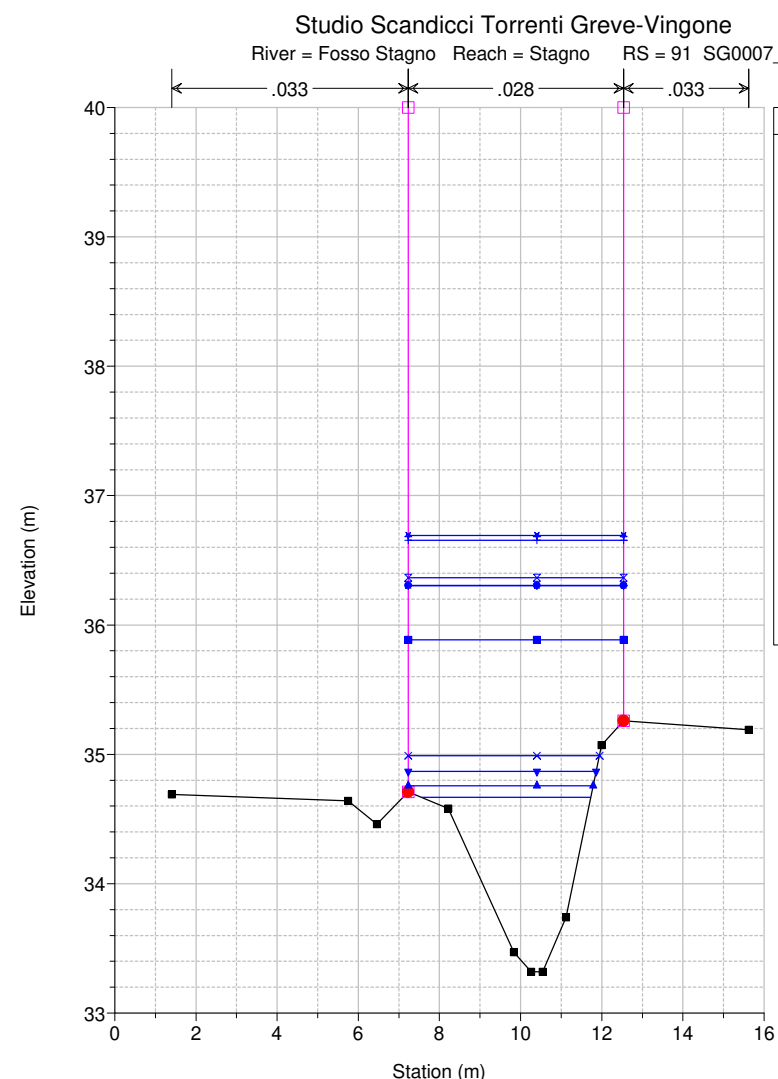

Studio Scandicci Torrenti Greve-Vingone
River = Fosso Stagno Reach = Stagno RS = 87 SG0008

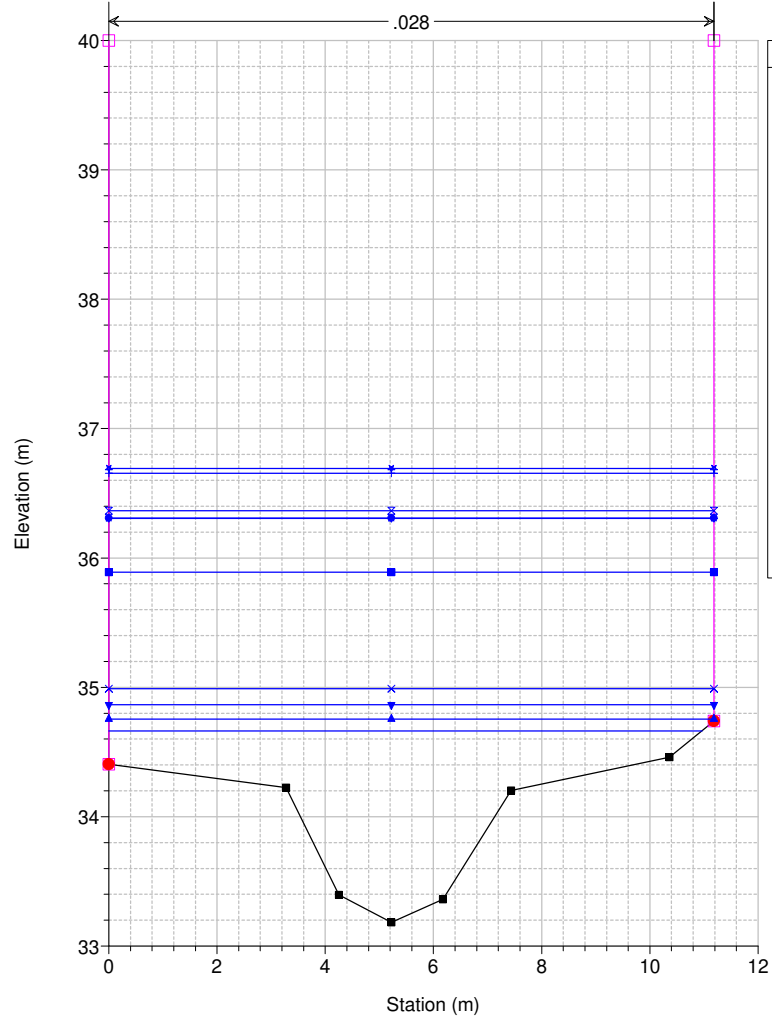

Legend

- WS Max WS - TR200_24_0
- WS Max WS - TR200_18_0
- WS Max WS - TR200_12_0
- WS Max WS - TR200_09_0
- WS Max WS - TR200_36_0
- WS Max WS - TR200_06_0
- WS Max WS - TR200_03_0
- WS Max WS - TR200_01_5
- WS Max WS - TR200_01_0
- WS Max WS - TR200_00_5
- Ground
- Levee
- Bank Sta

Studio Scandicci Torrenti Greve-Vingone
River = Fosso Stagno Reach = Stagno RS = 86 SG0009

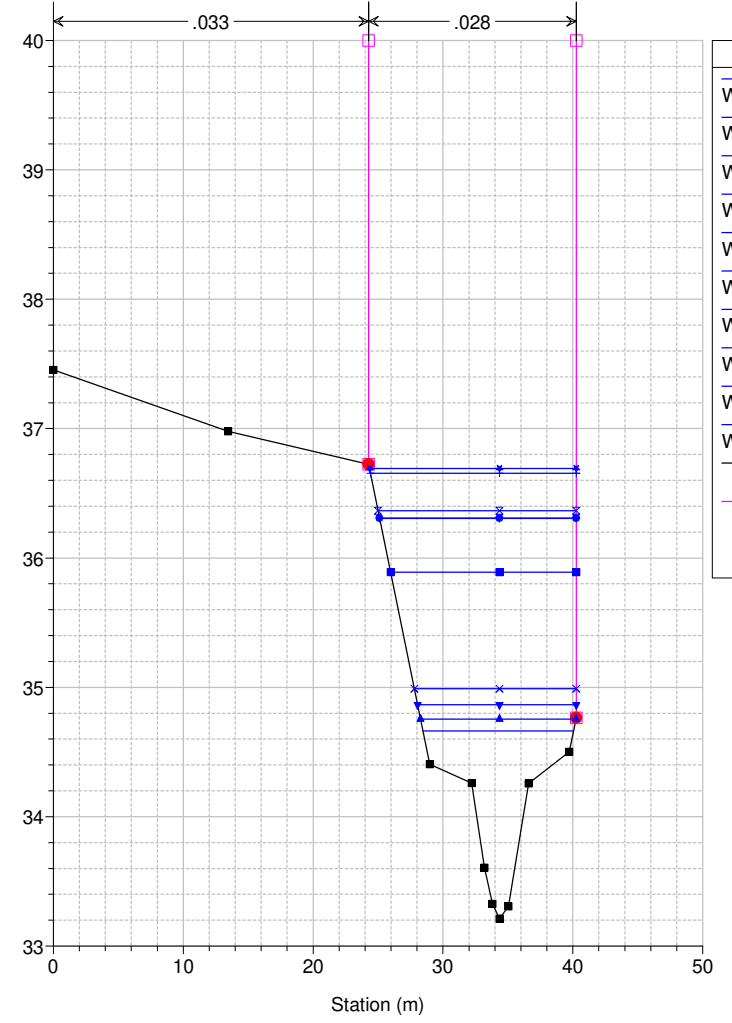

Legend

- WS Max WS - TR200_24_0
- WS Max WS - TR200_18_0
- WS Max WS - TR200_12_0
- WS Max WS - TR200_09_0
- WS Max WS - TR200_36_0
- WS Max WS - TR200_06_0
- WS Max WS - TR200_03_0
- WS Max WS - TR200_01_5
- WS Max WS - TR200_01_0
- WS Max WS - TR200_00_5
- Ground
- Levee
- Bank Sta

Studio Scandicci Torrenti Greve-Vingone
River = Fosso Stagno Reach = Stagno RS = 85 SG0010

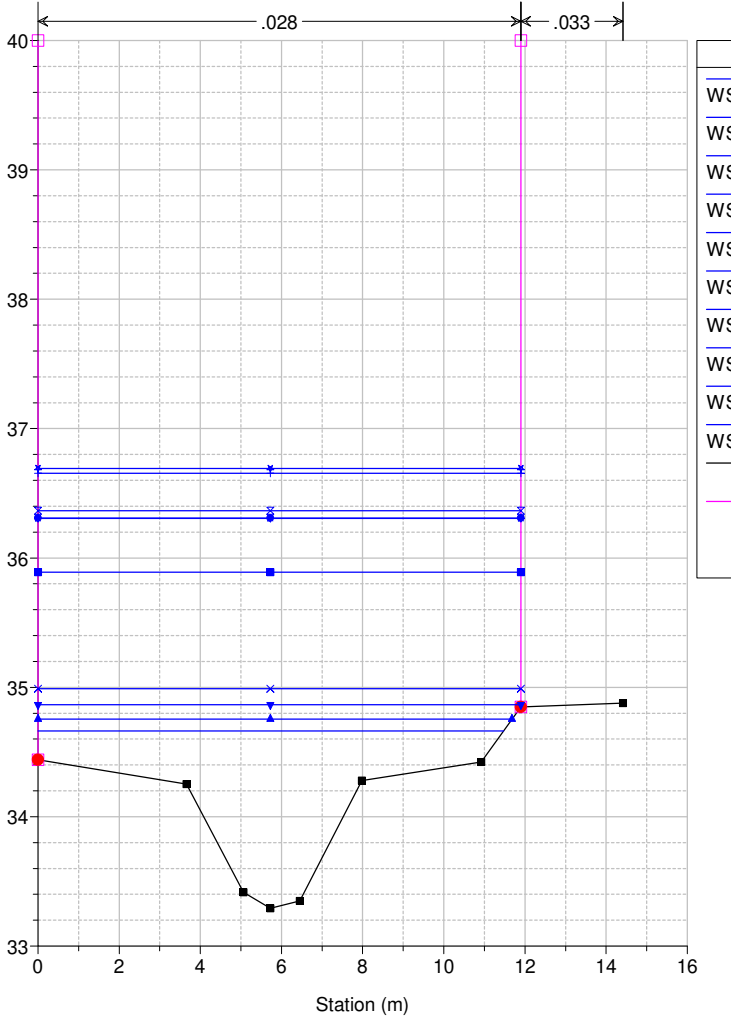

Legend

- WS Max WS - TR200_24_0
- WS Max WS - TR200_18_0
- WS Max WS - TR200_12_0
- WS Max WS - TR200_09_0
- WS Max WS - TR200_36_0
- WS Max WS - TR200_06_0
- WS Max WS - TR200_03_0
- WS Max WS - TR200_01_5
- WS Max WS - TR200_01_0
- WS Max WS - TR200_00_5
- Ground
- Levee
- Bank Sta

Studio Scandicci Torrenti Greve-Vingone
River = Fosso Stagno Reach = Stagno RS = 84 SG0011

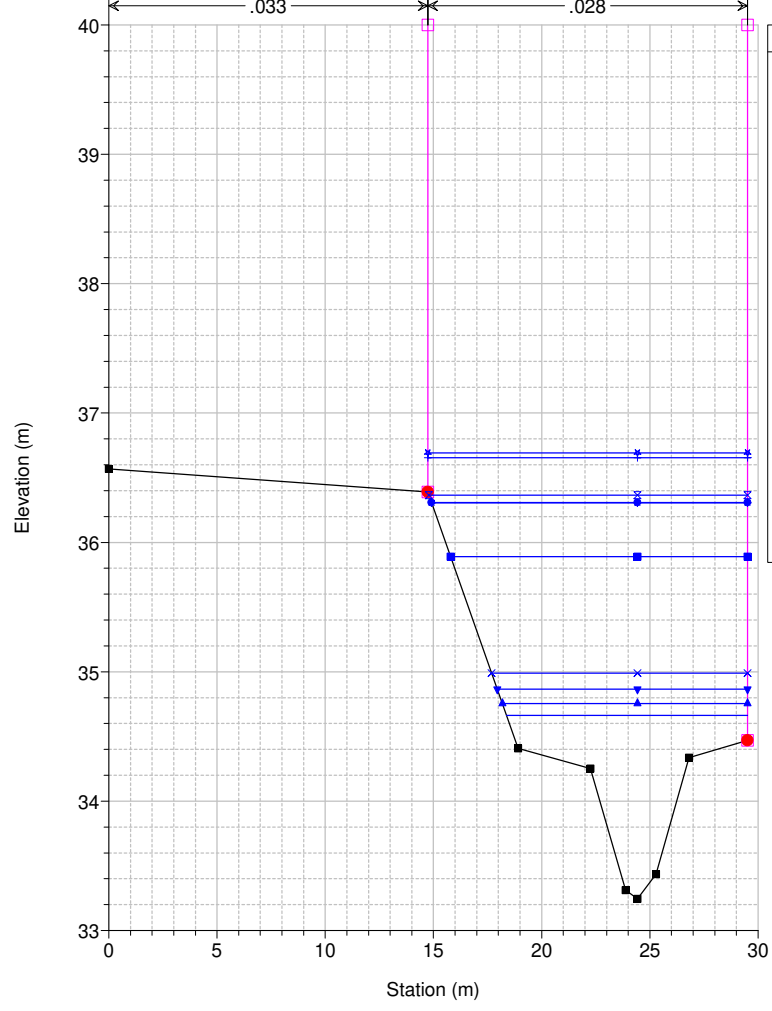

Legend

- WS Max WS - TR200_24_0
- WS Max WS - TR200_18_0
- WS Max WS - TR200_12_0
- WS Max WS - TR200_09_0
- WS Max WS - TR200_36_0
- WS Max WS - TR200_06_0
- WS Max WS - TR200_03_0
- WS Max WS - TR200_01_5
- WS Max WS - TR200_01_0
- WS Max WS - TR200_00_5
- Ground
- Levee
- Bank Sta

Studio Scandicci Torrenti Greve-Vingone
River = Fosso Stagno Reach = Stagno RS = 83 SG0012_A

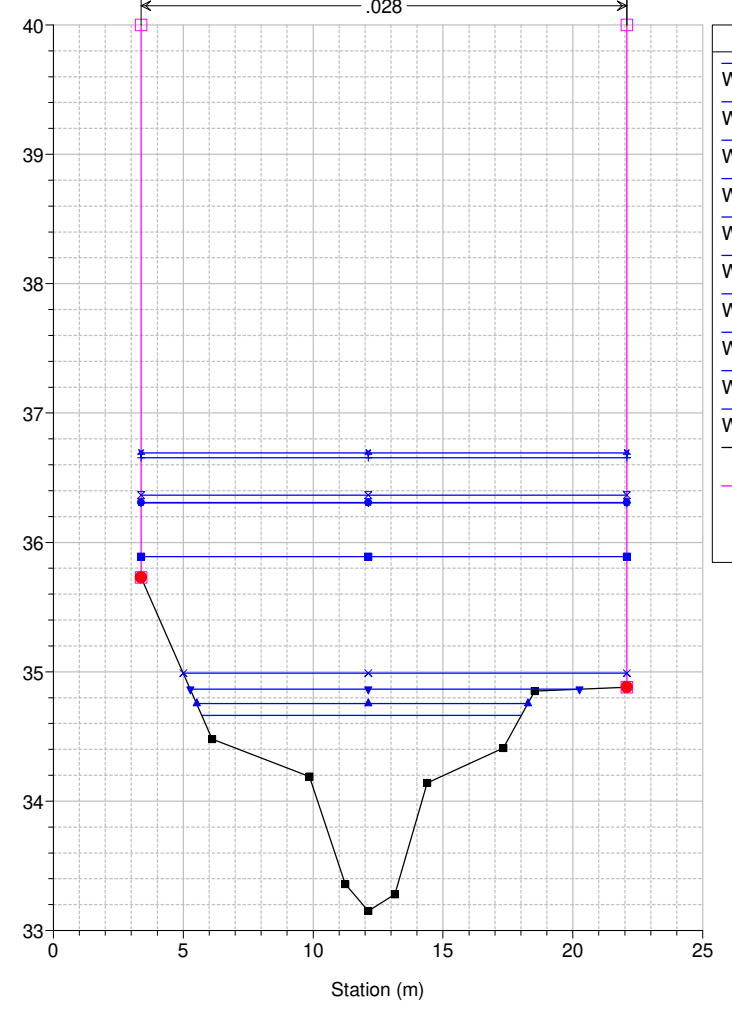

Legend

- WS Max WS - TR200_24_0
- WS Max WS - TR200_18_0
- WS Max WS - TR200_12_0
- WS Max WS - TR200_09_0
- WS Max WS - TR200_36_0
- WS Max WS - TR200_06_0
- WS Max WS - TR200_03_0
- WS Max WS - TR200_01_5
- WS Max WS - TR200_01_0
- WS Max WS - TR200_00_5
- Ground
- Levee
- Bank Sta

Studio Scandicci Torrenti Greve-Vingone
River = Fosso Stagno Reach = Stagno RS = 82 SG0012_B

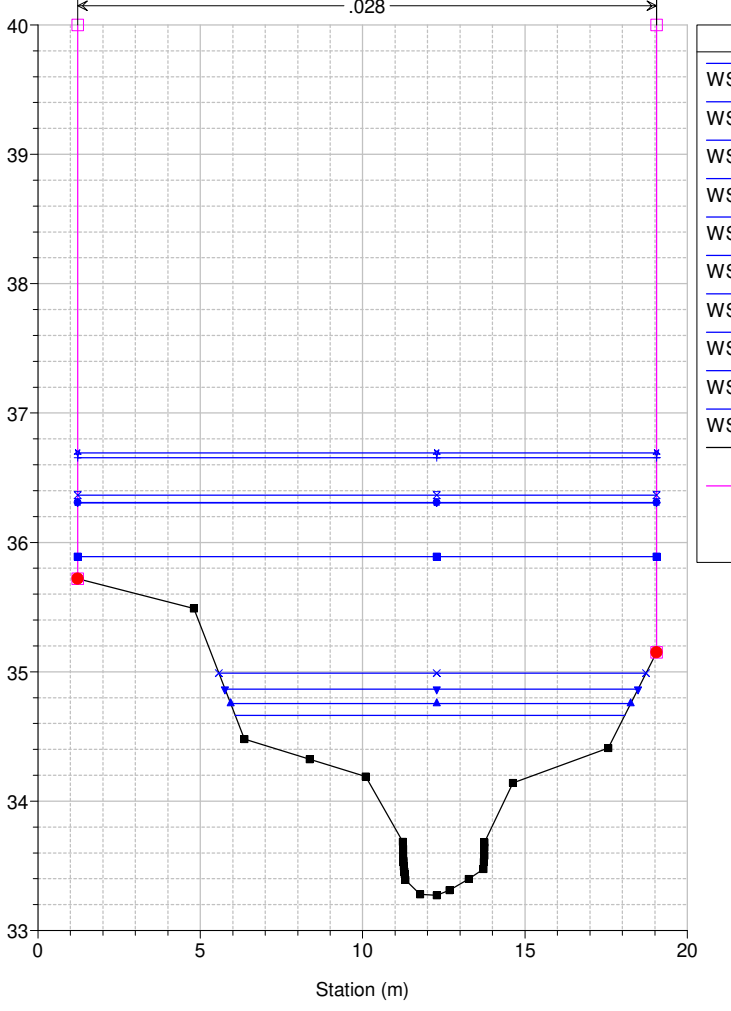

Legend

- WS Max WS - TR200_24_0
- WS Max WS - TR200_18_0
- WS Max WS - TR200_12_0
- WS Max WS - TR200_09_0
- WS Max WS - TR200_36_0
- WS Max WS - TR200_06_0
- WS Max WS - TR200_03_0
- WS Max WS - TR200_01_5
- WS Max WS - TR200_01_0
- WS Max WS - TR200_00_5
- Ground
- Levee
- Bank Sta

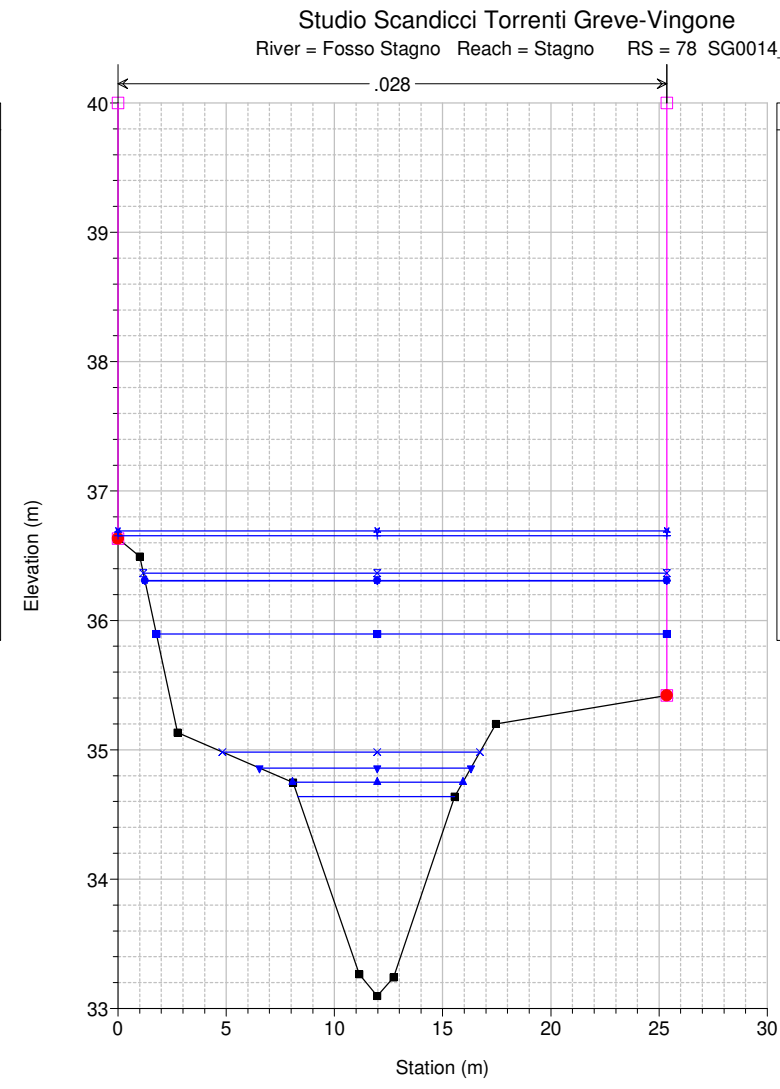
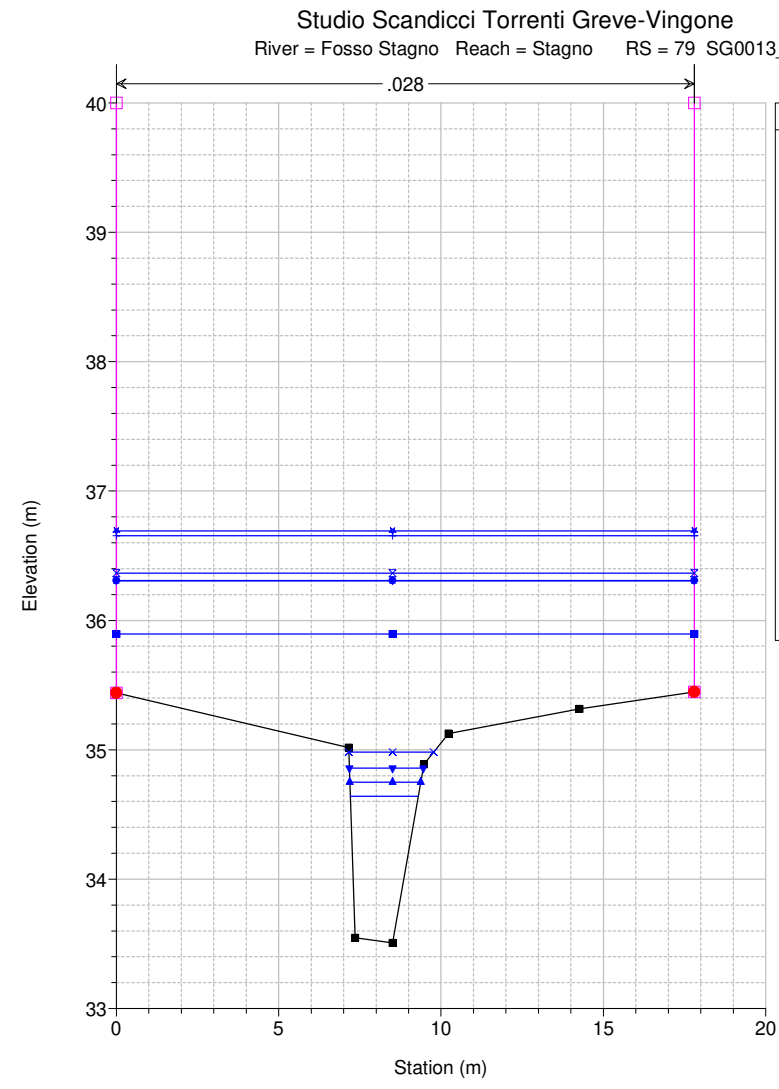
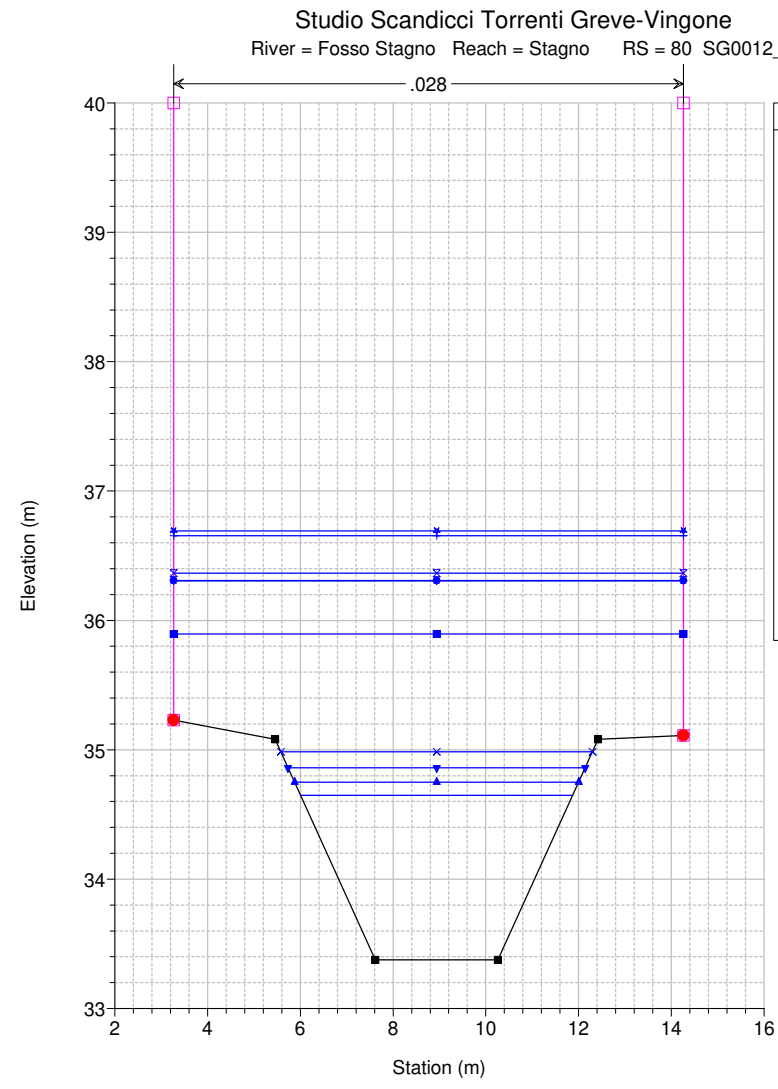
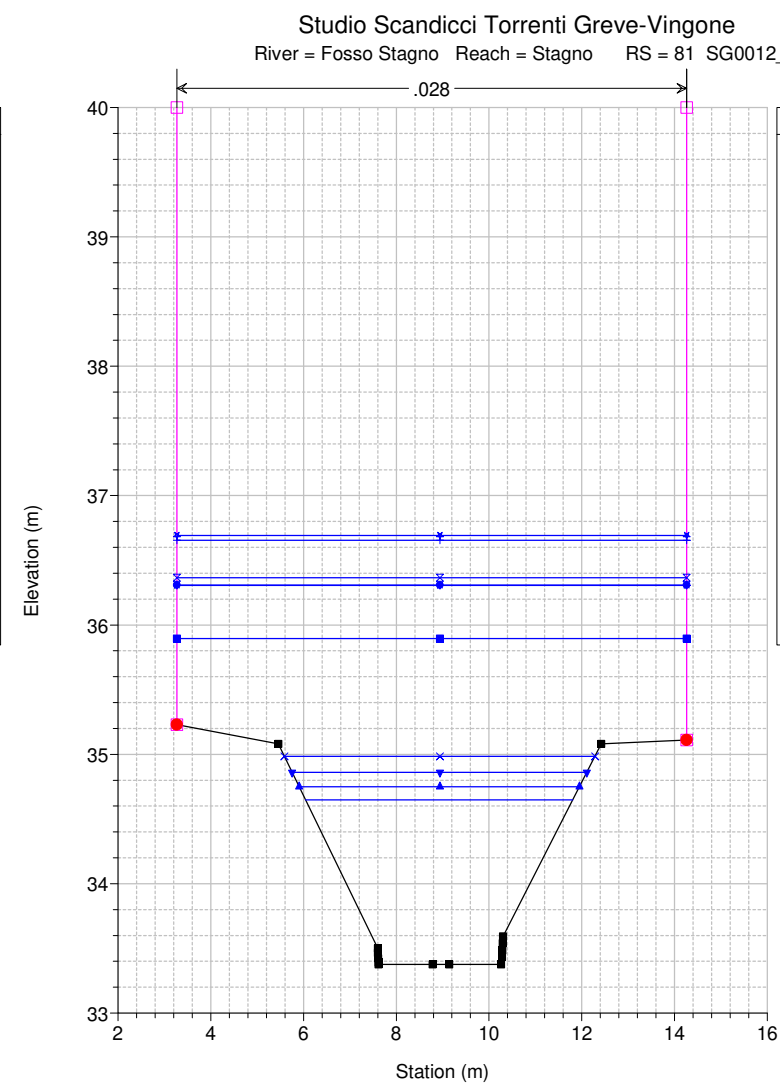
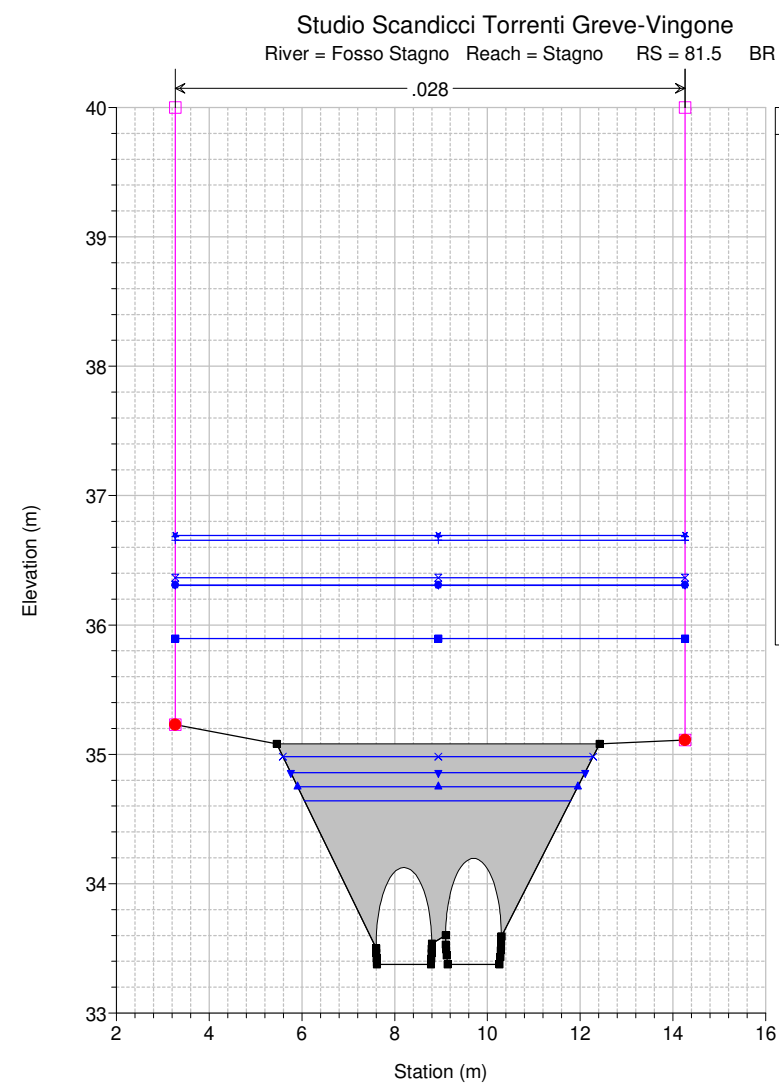
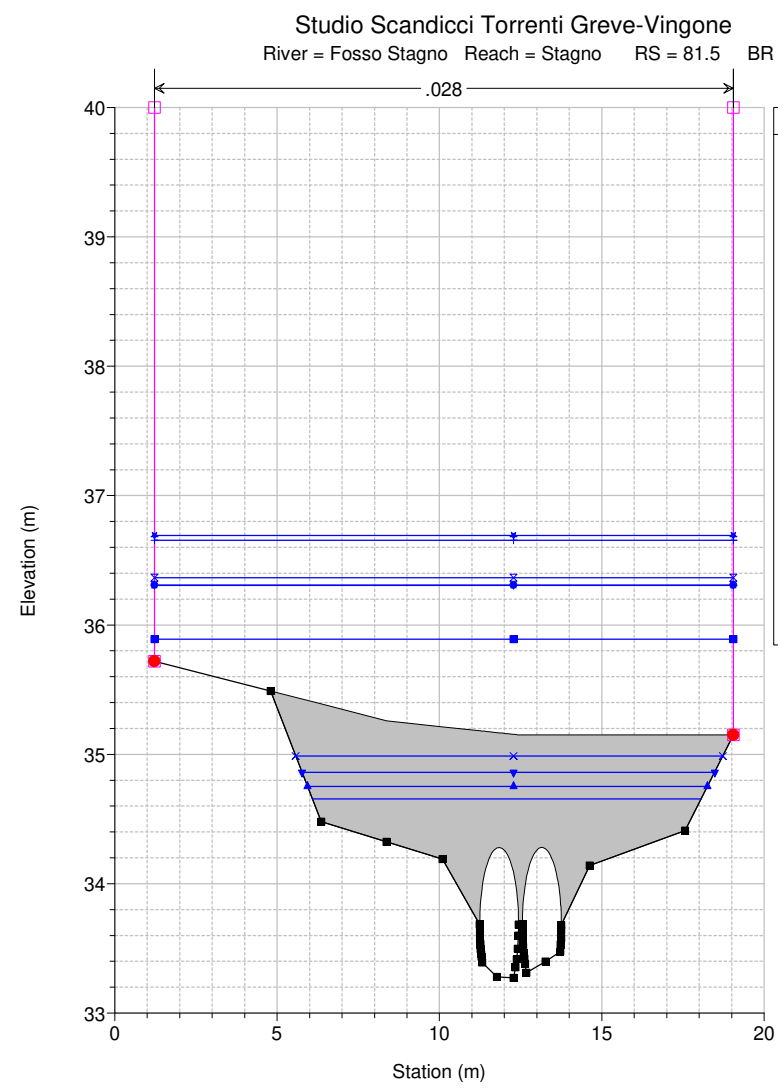

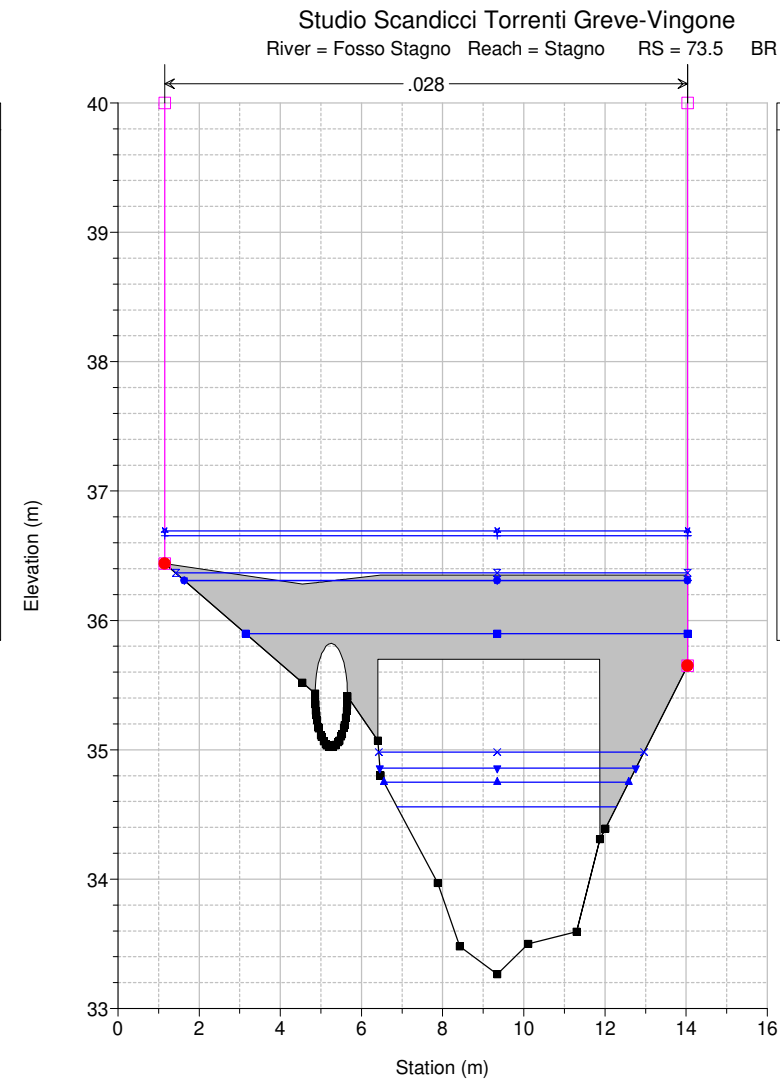
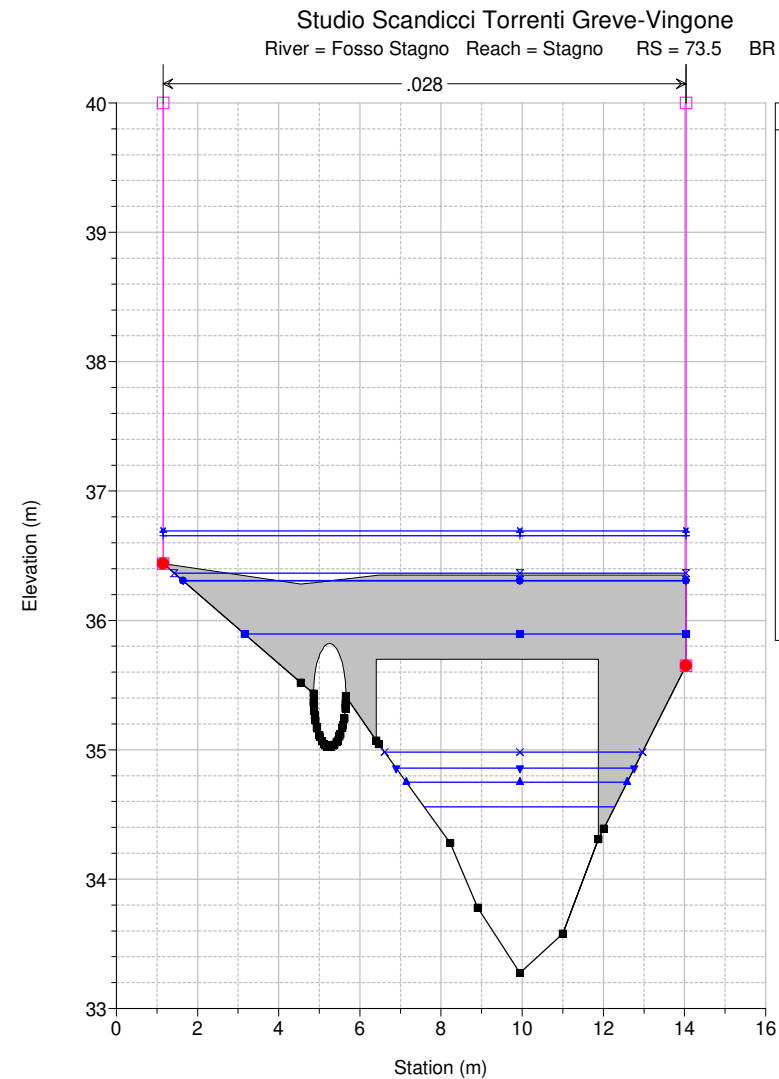
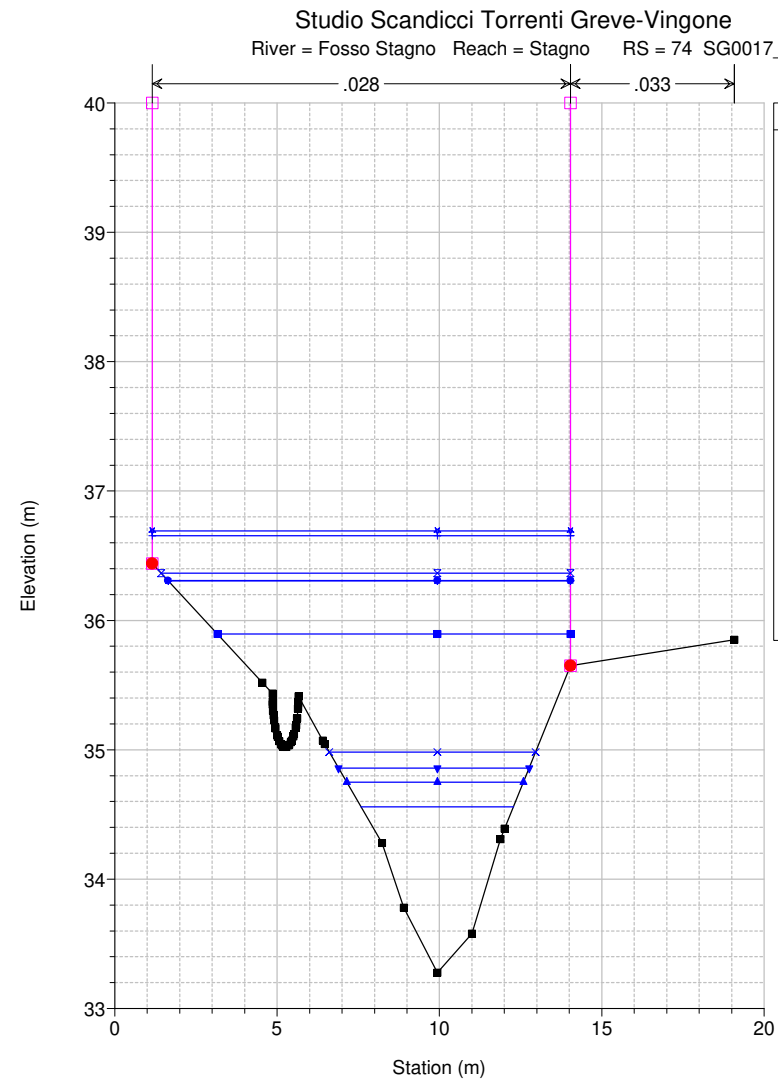
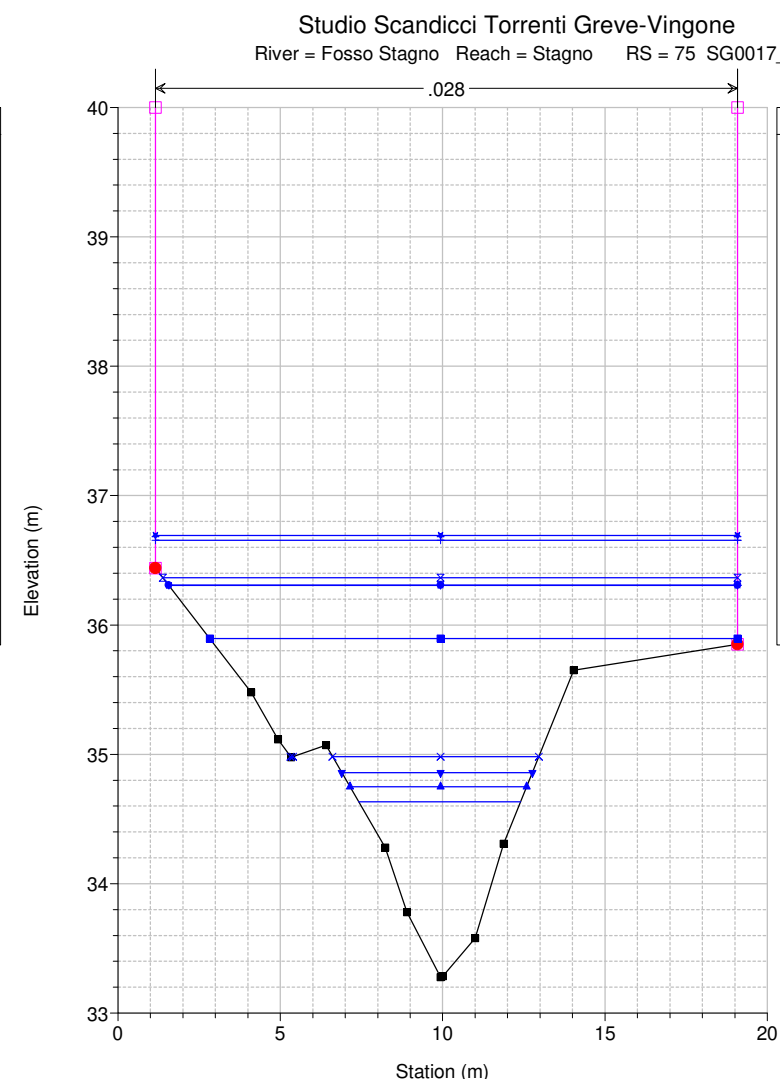
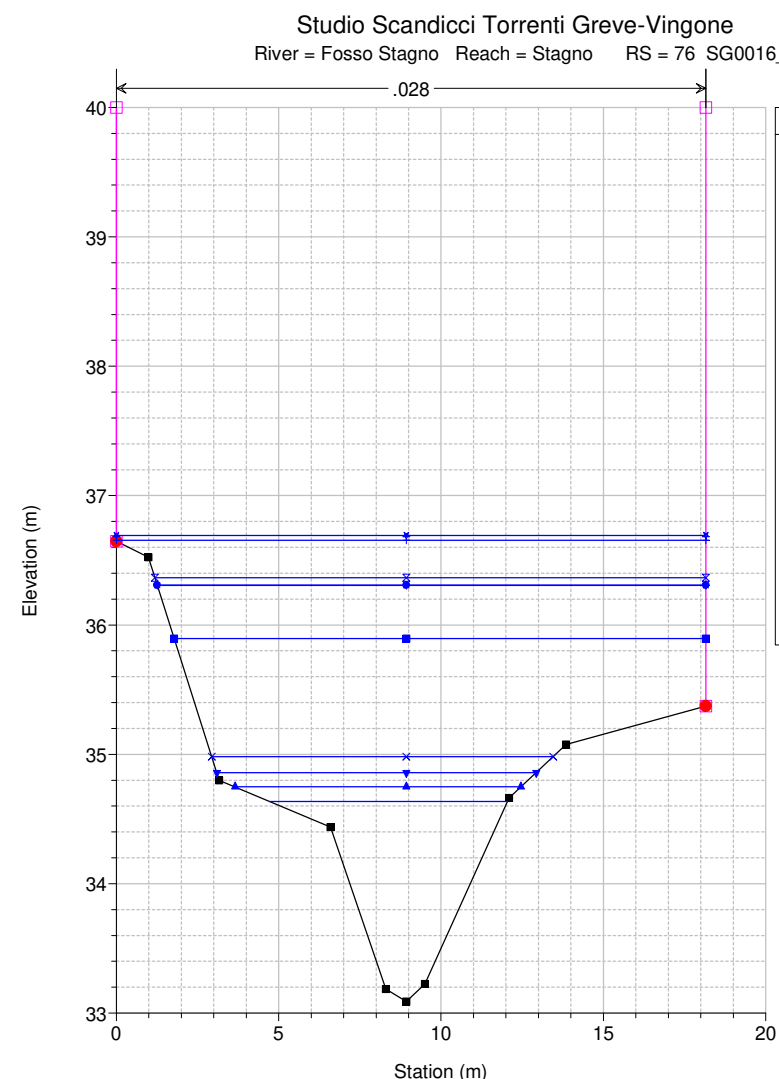
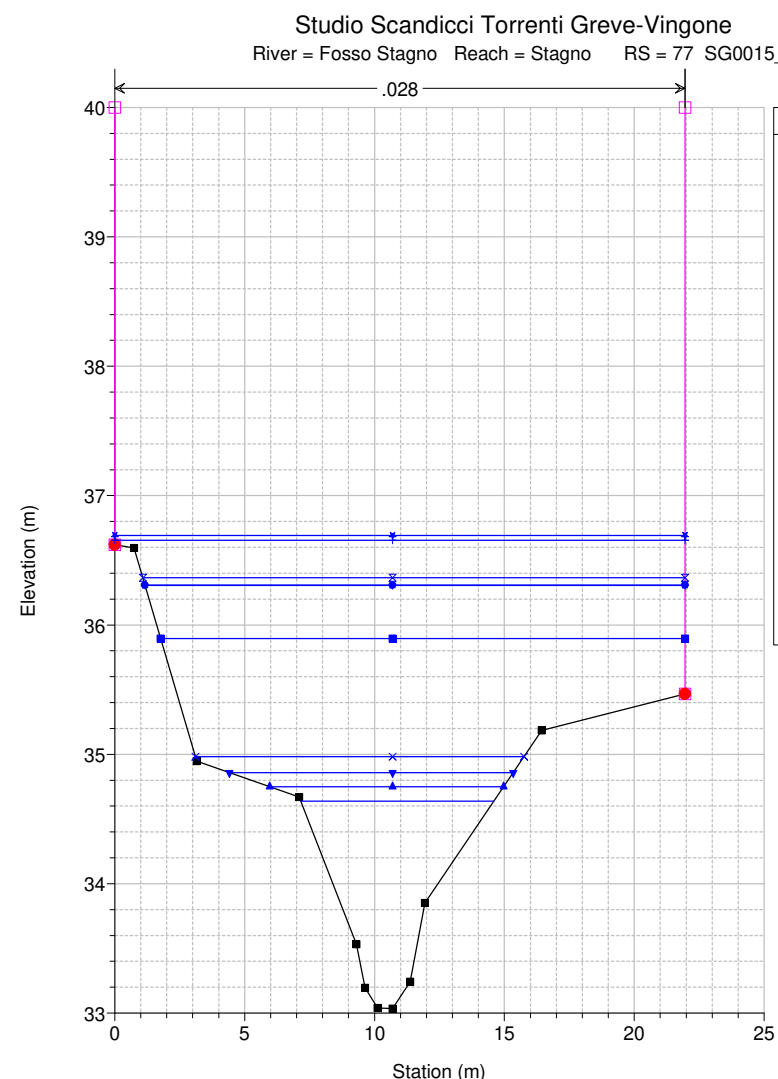

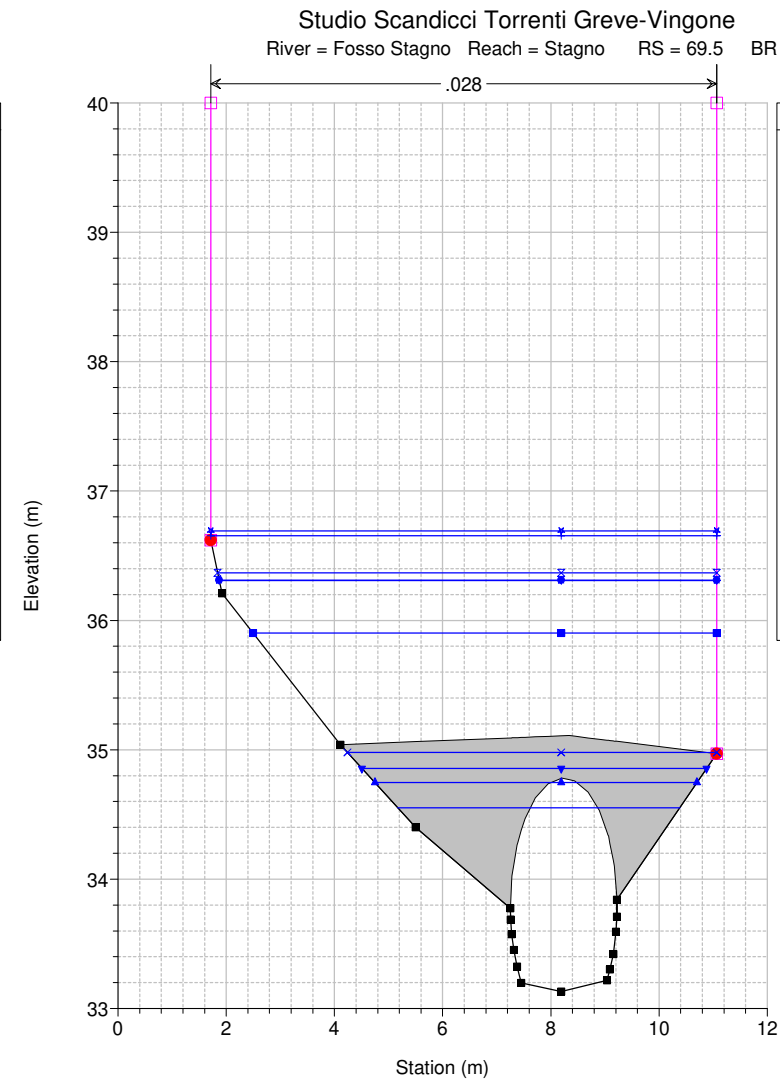
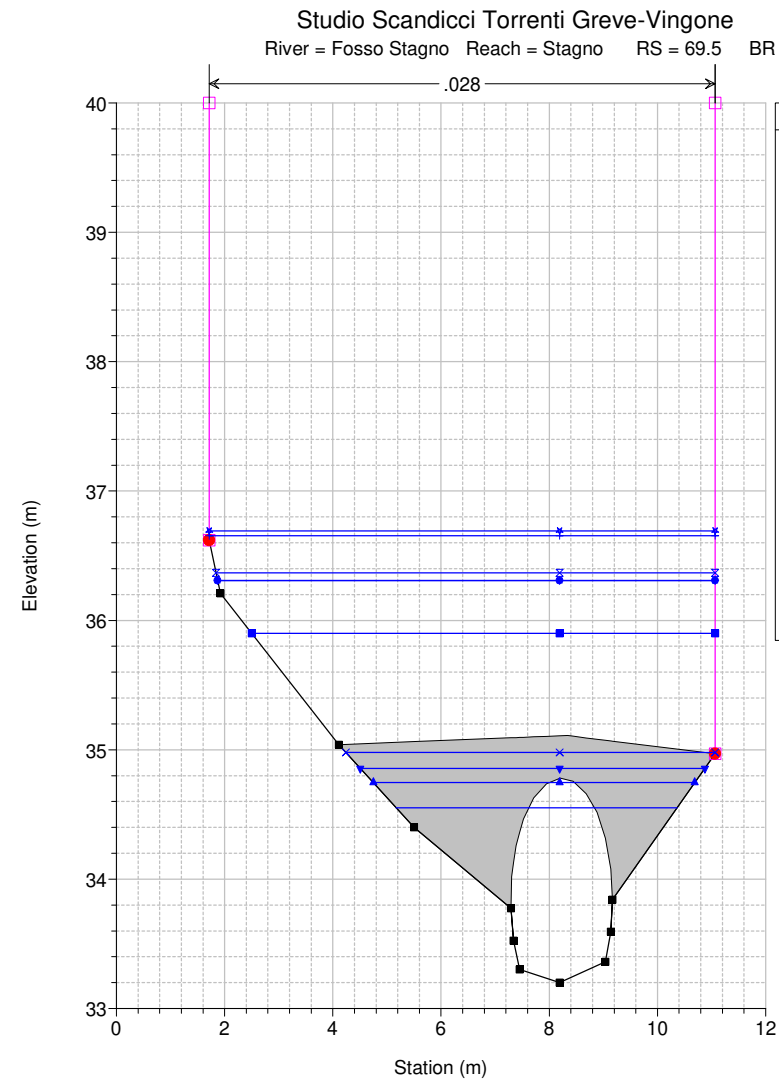
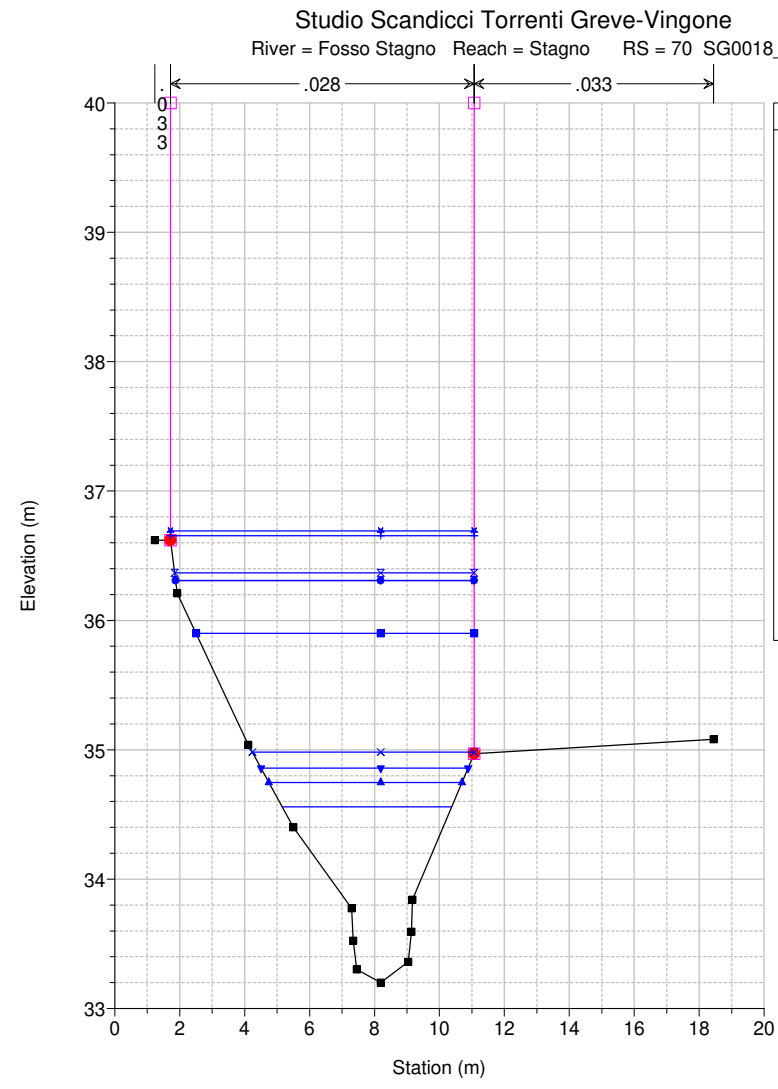
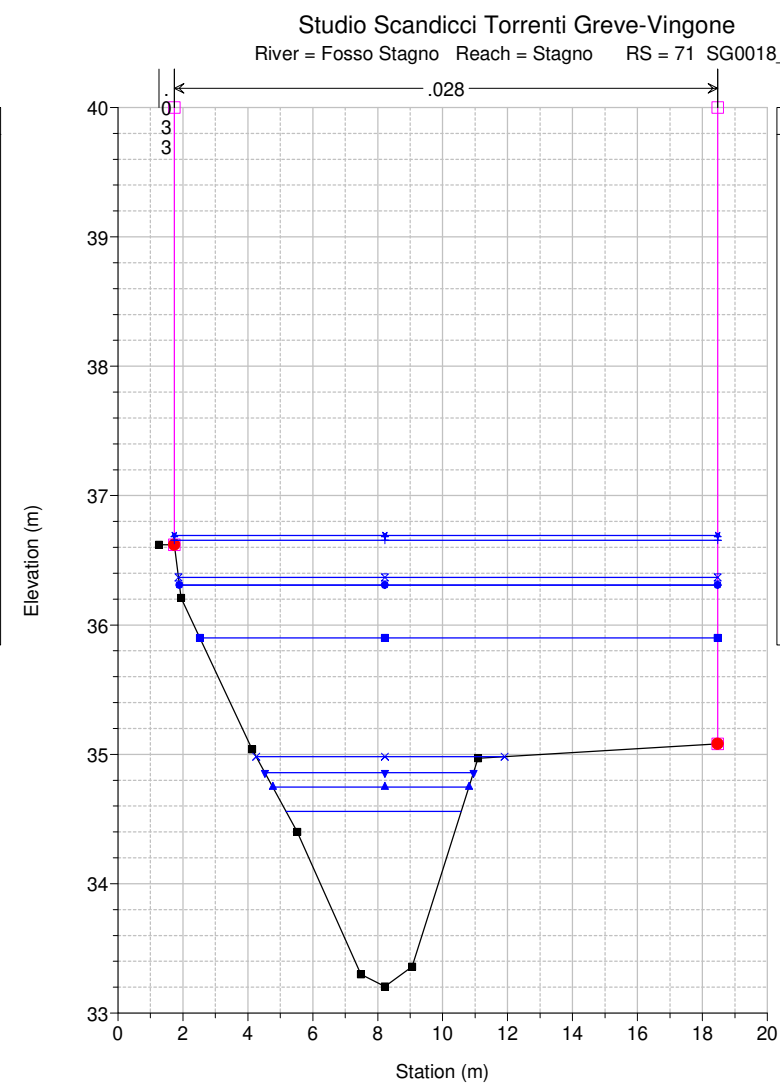
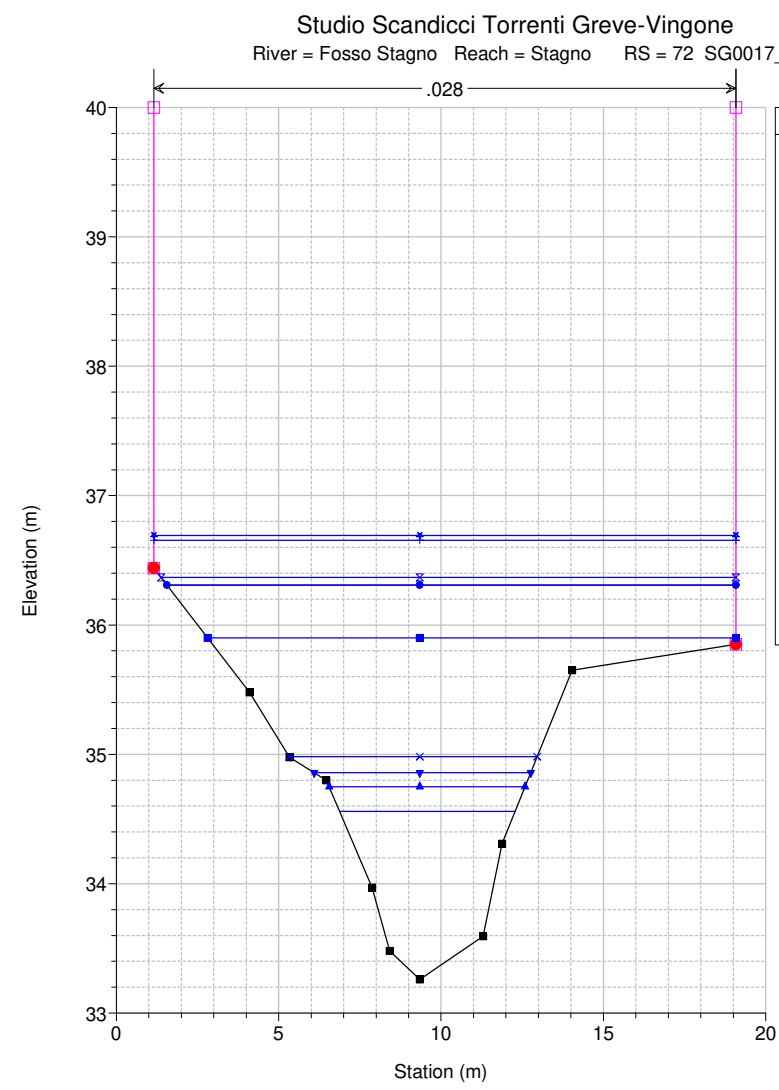
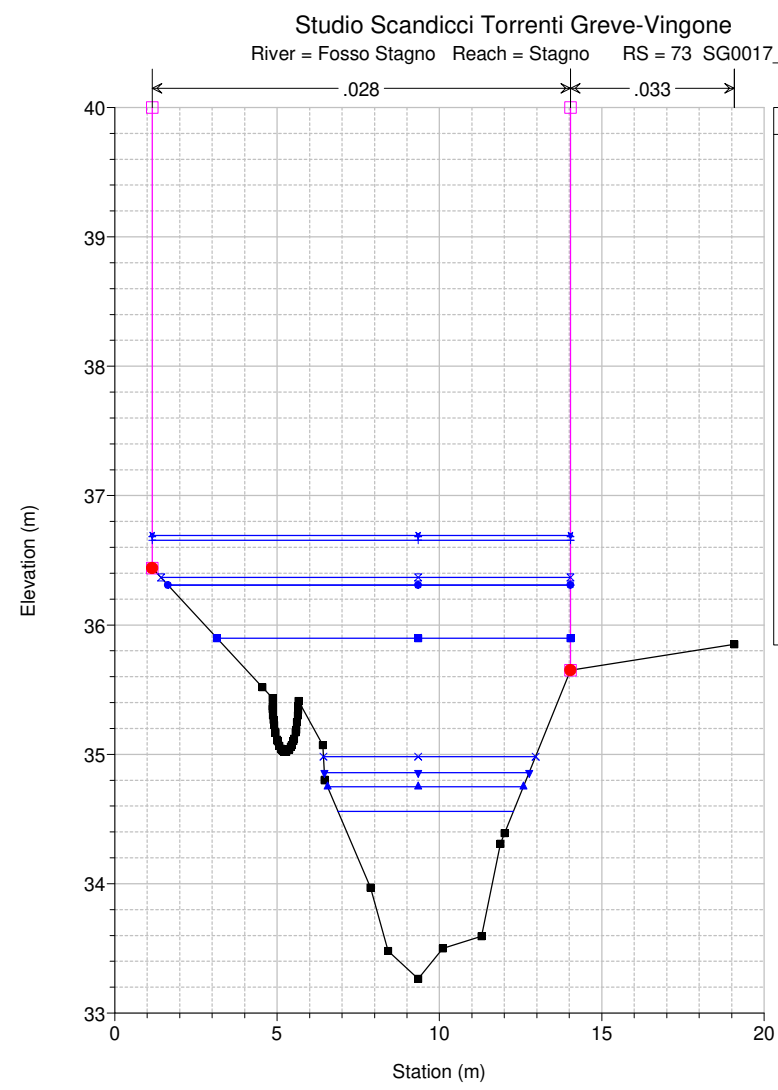

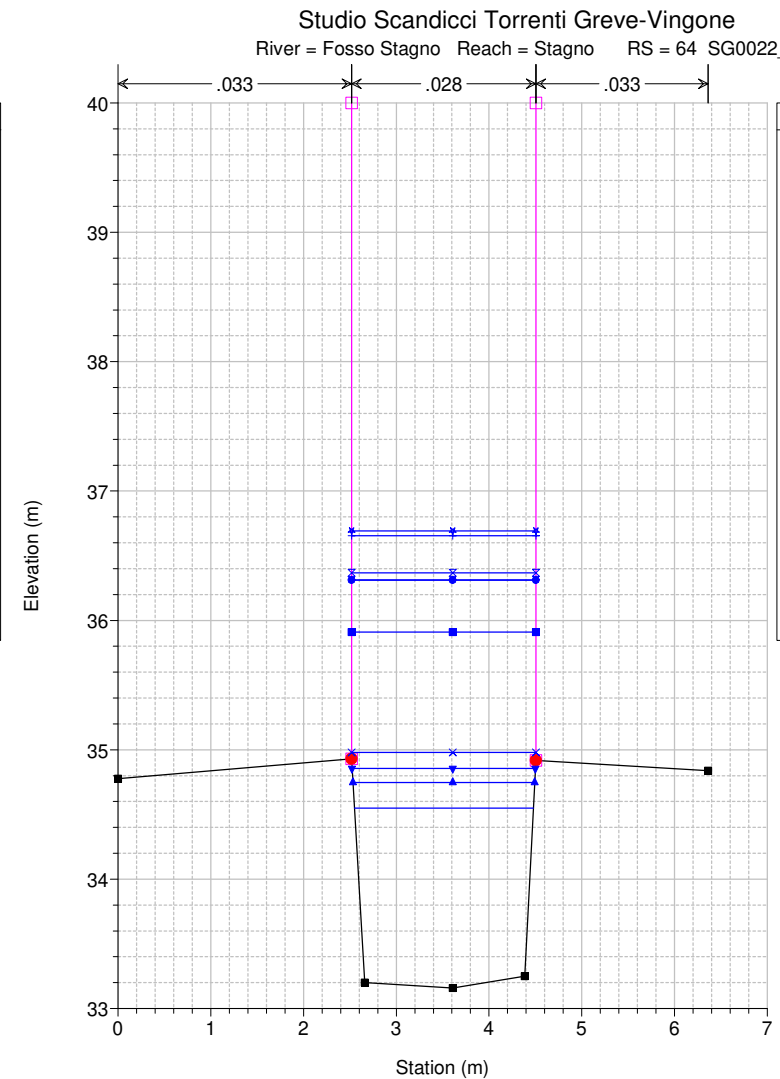
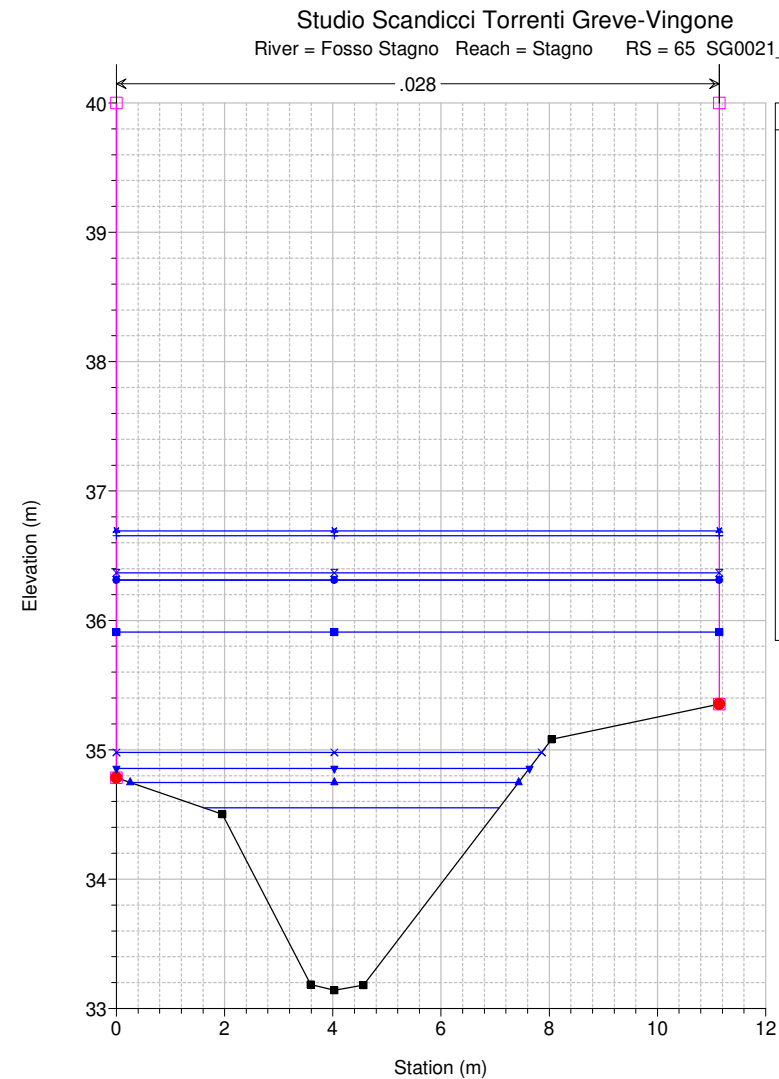
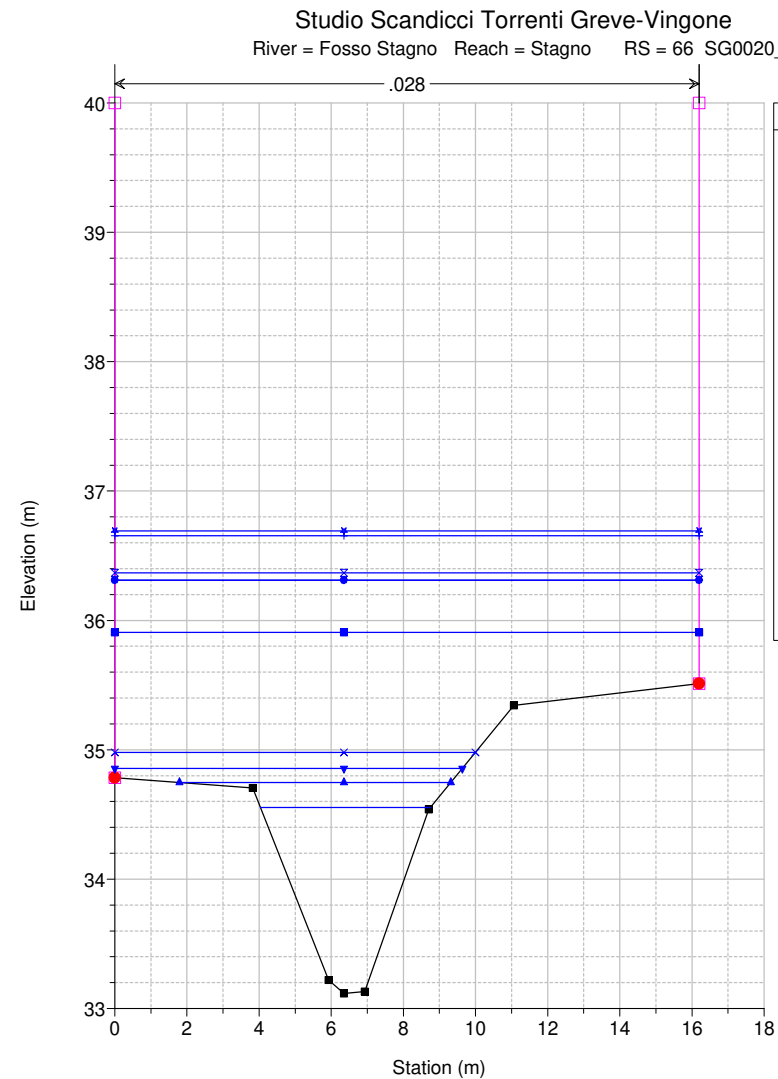
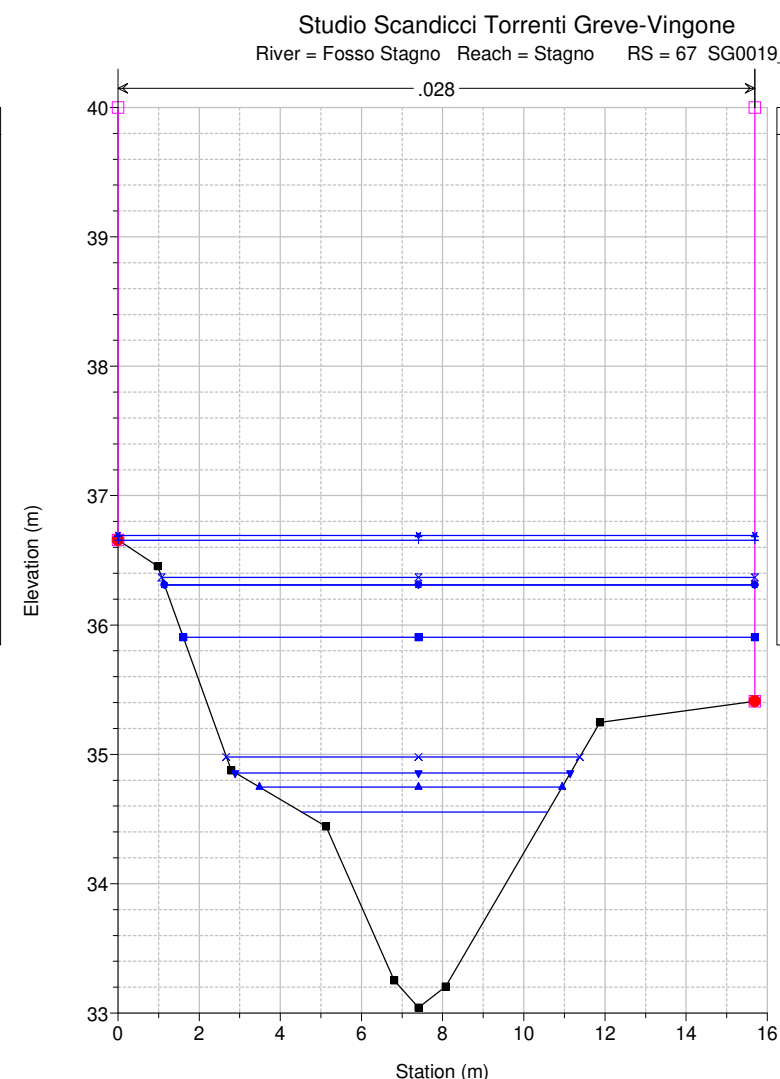
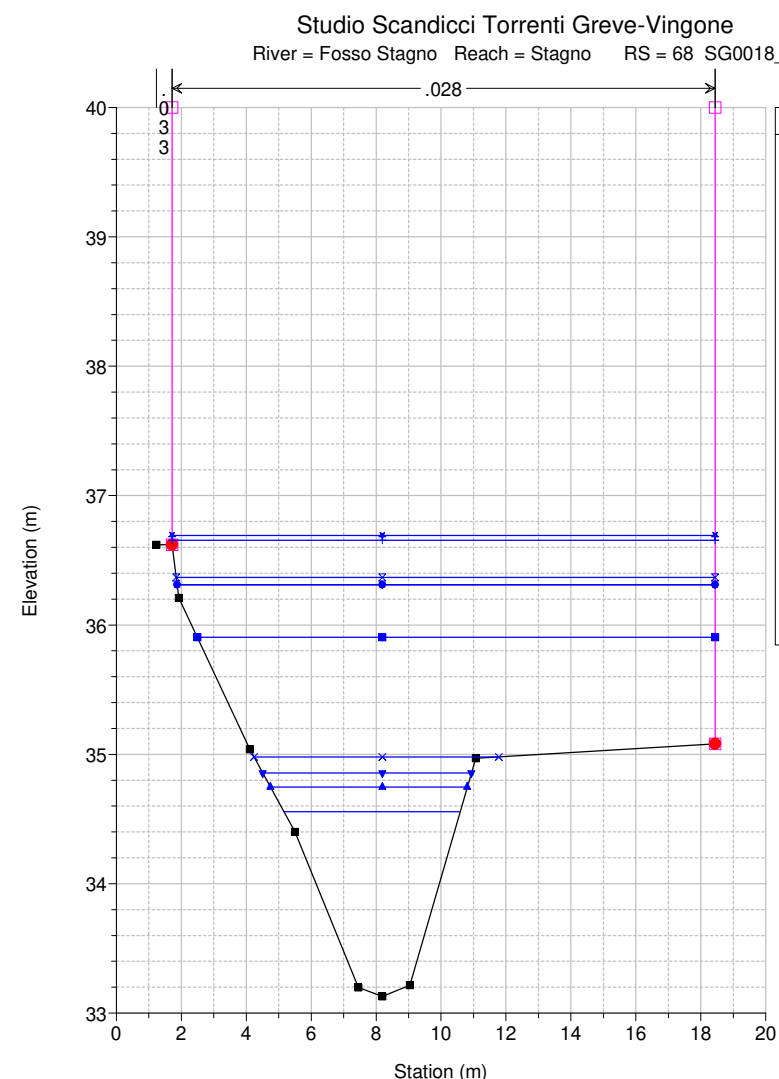
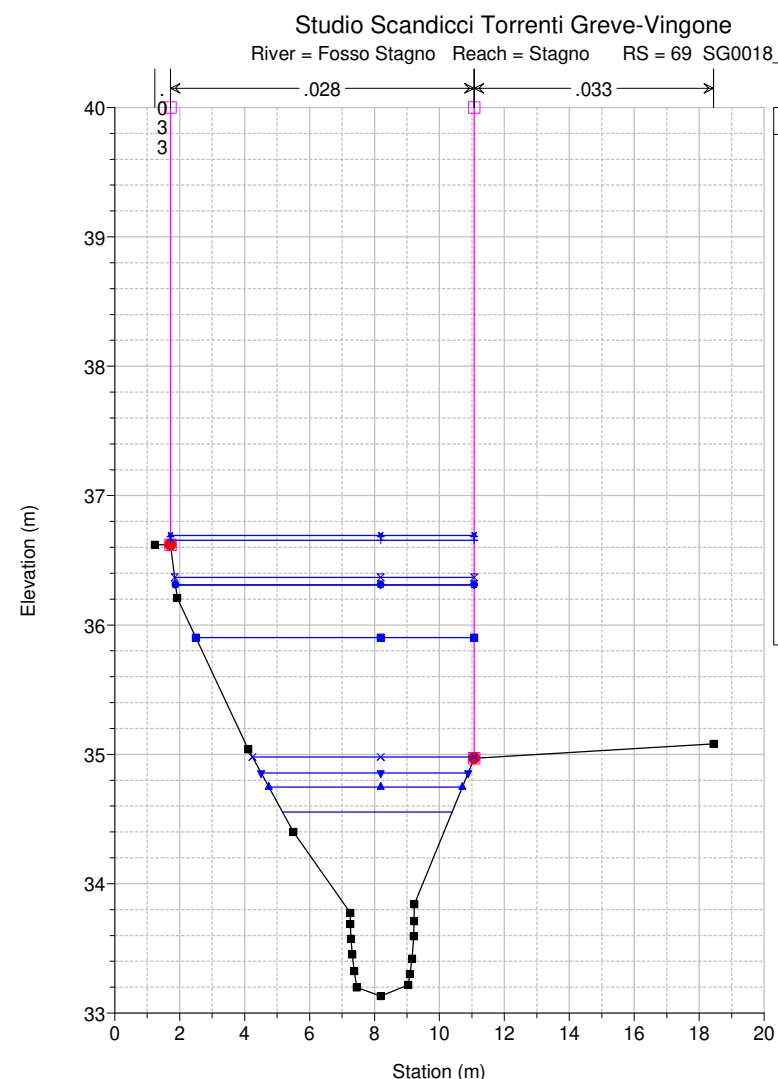

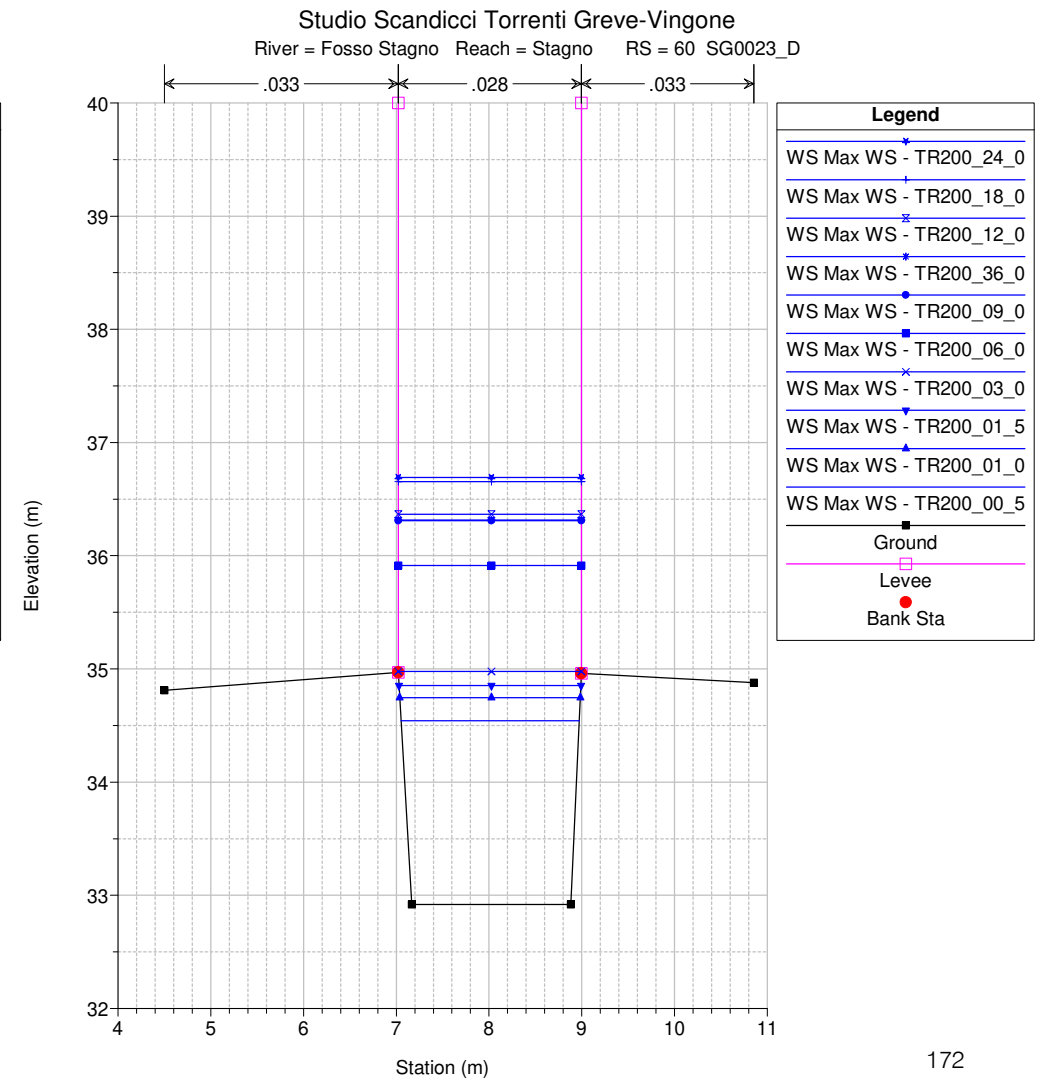
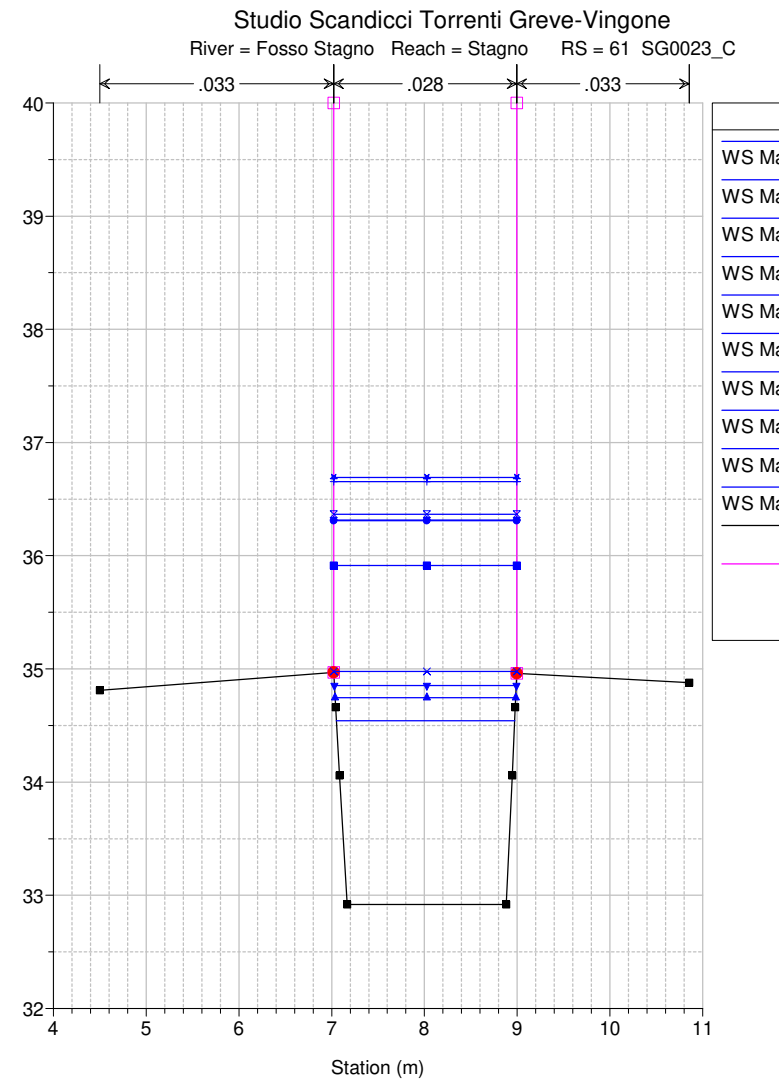
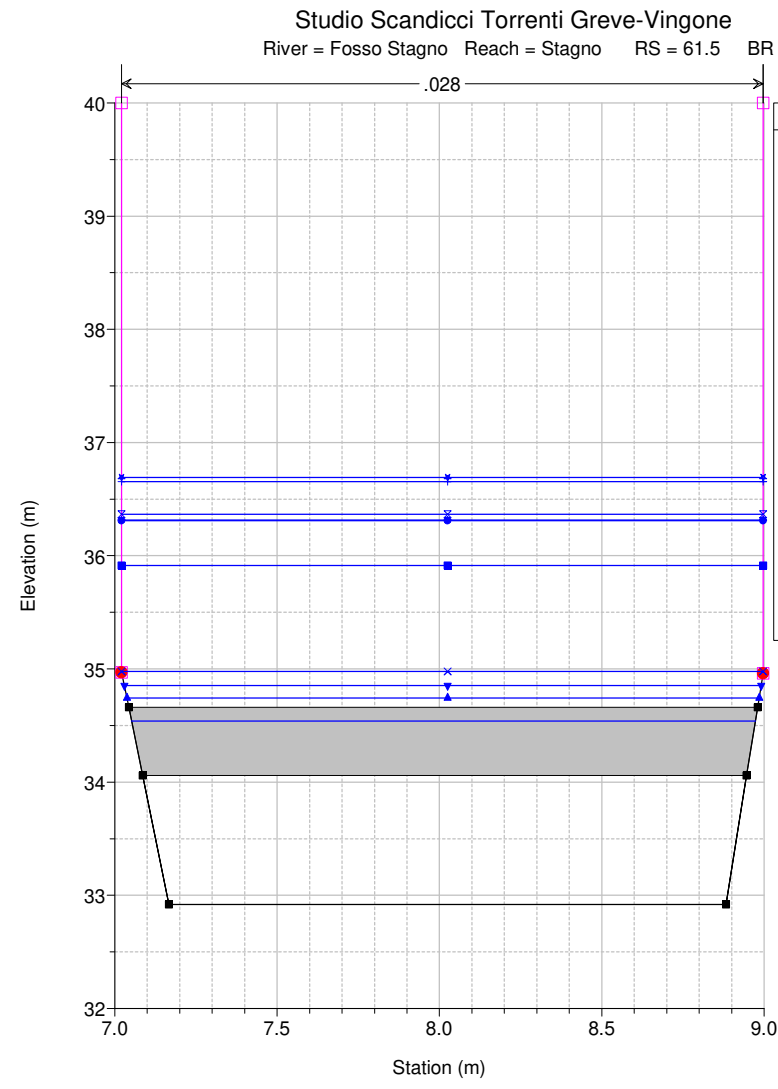
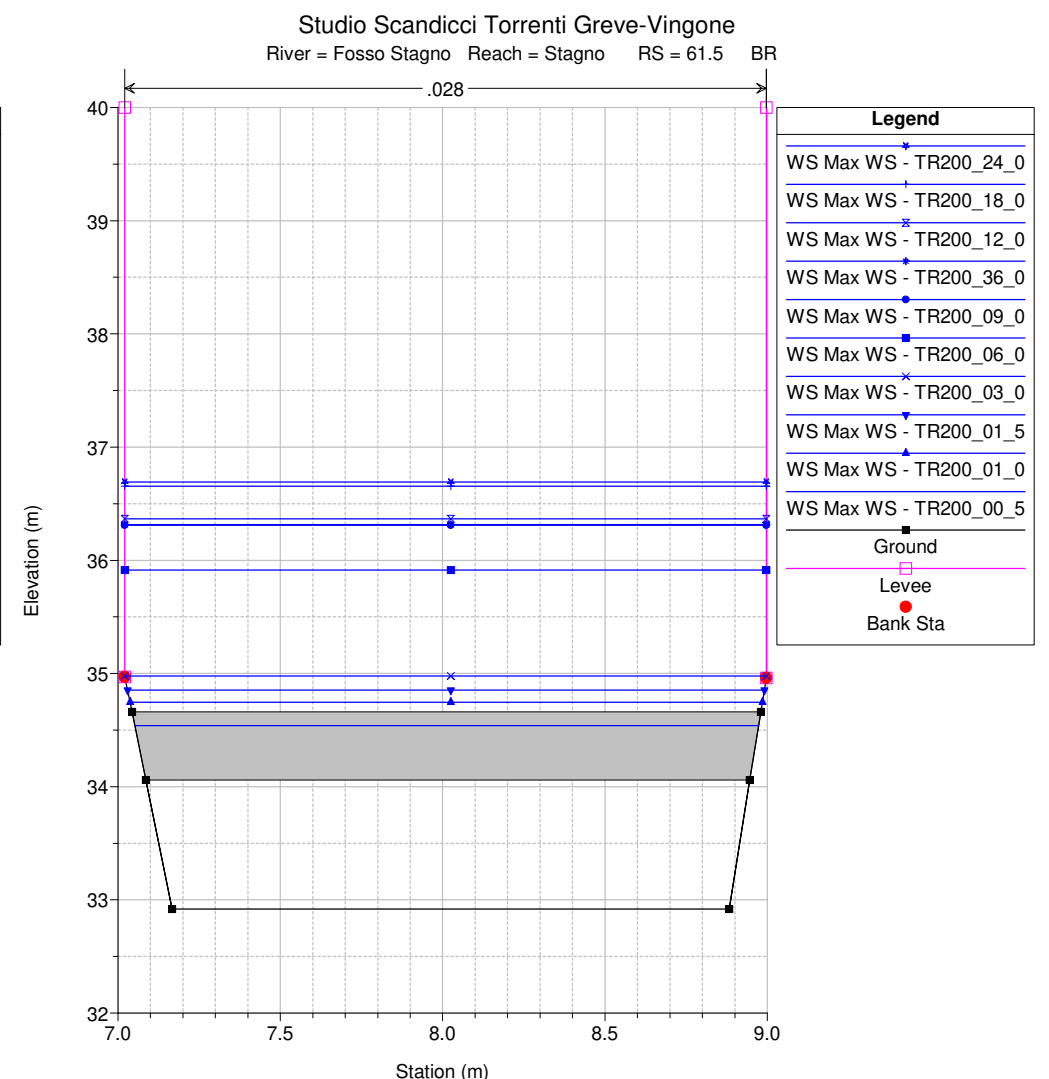
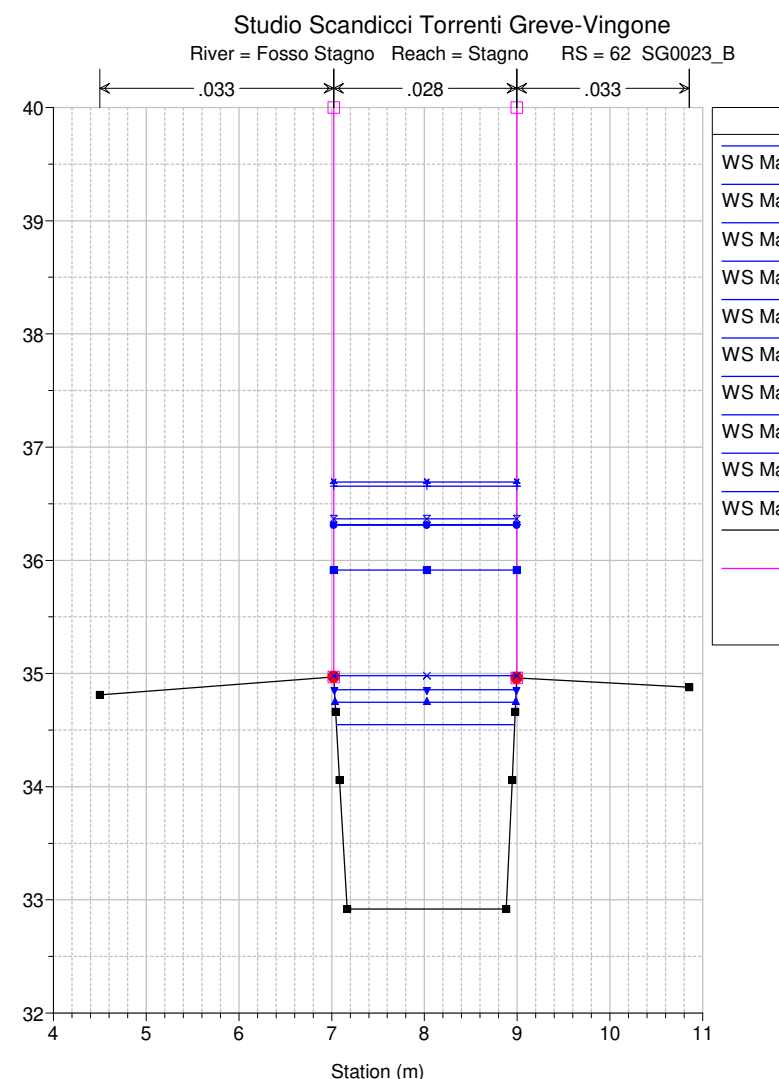
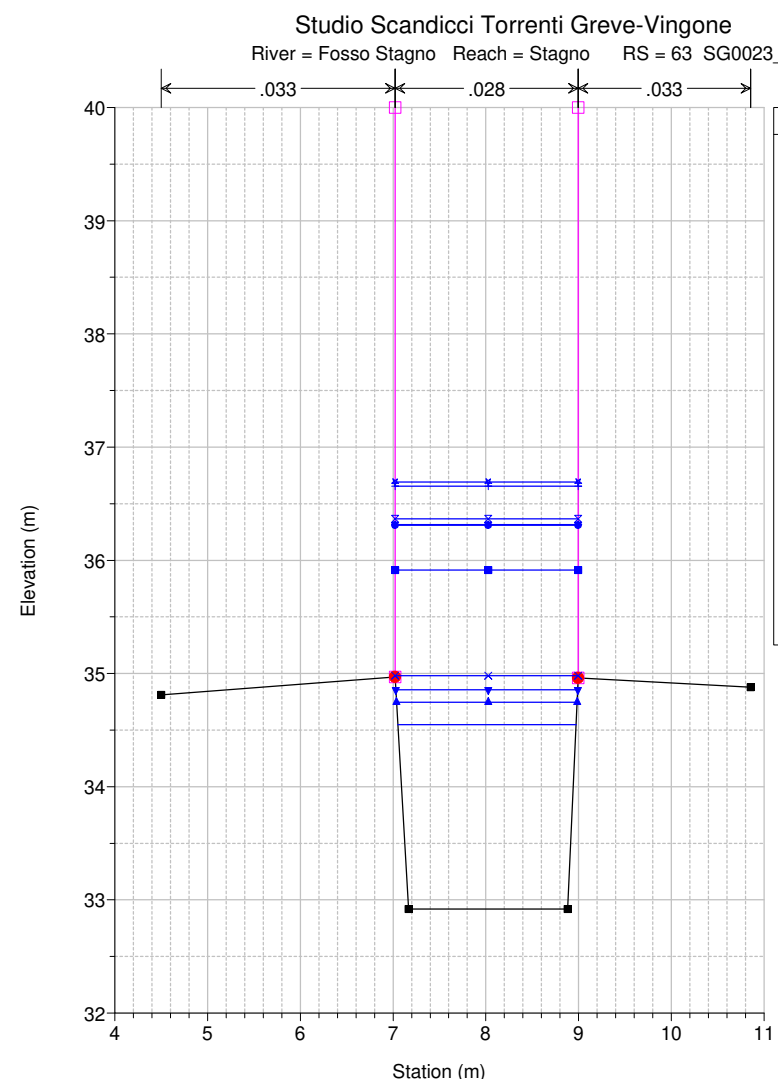

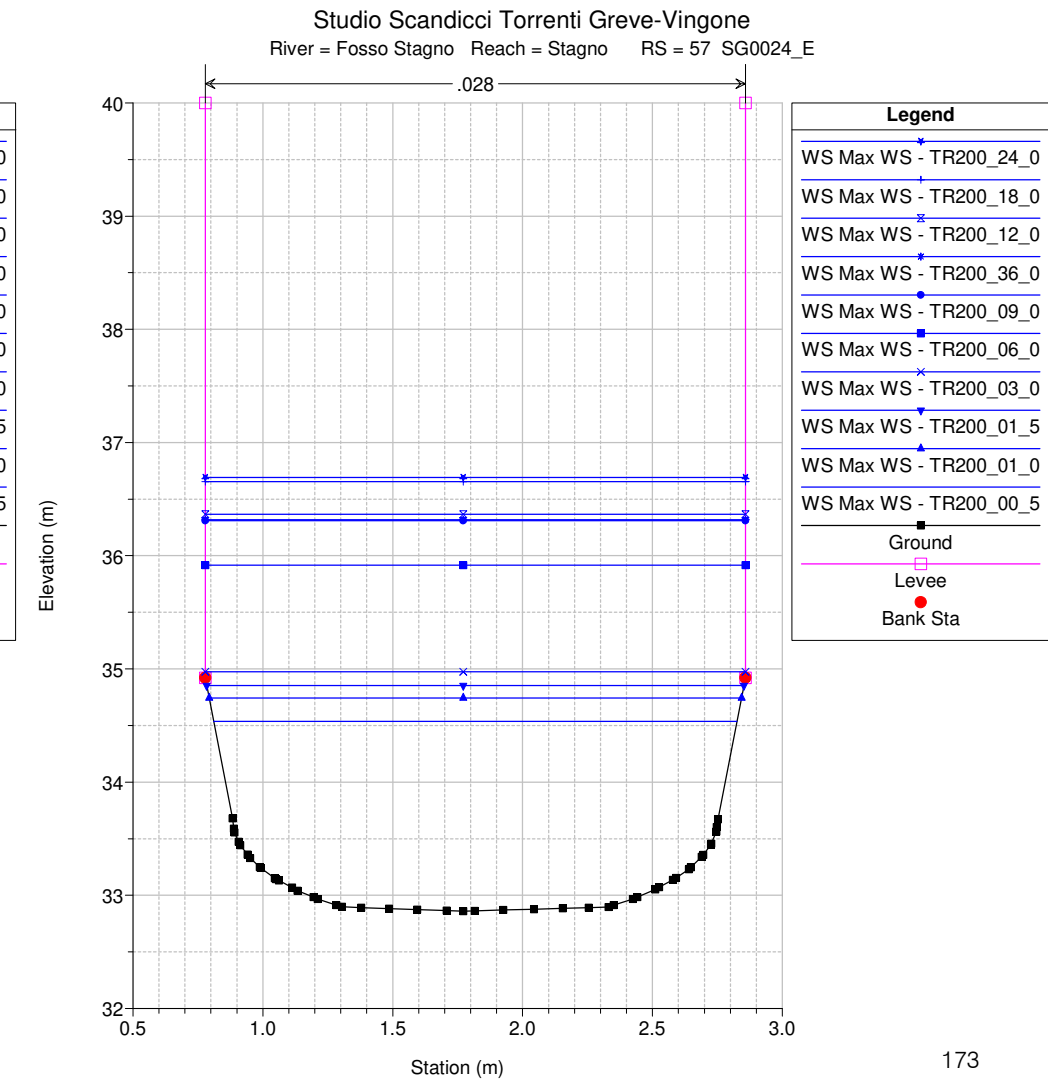
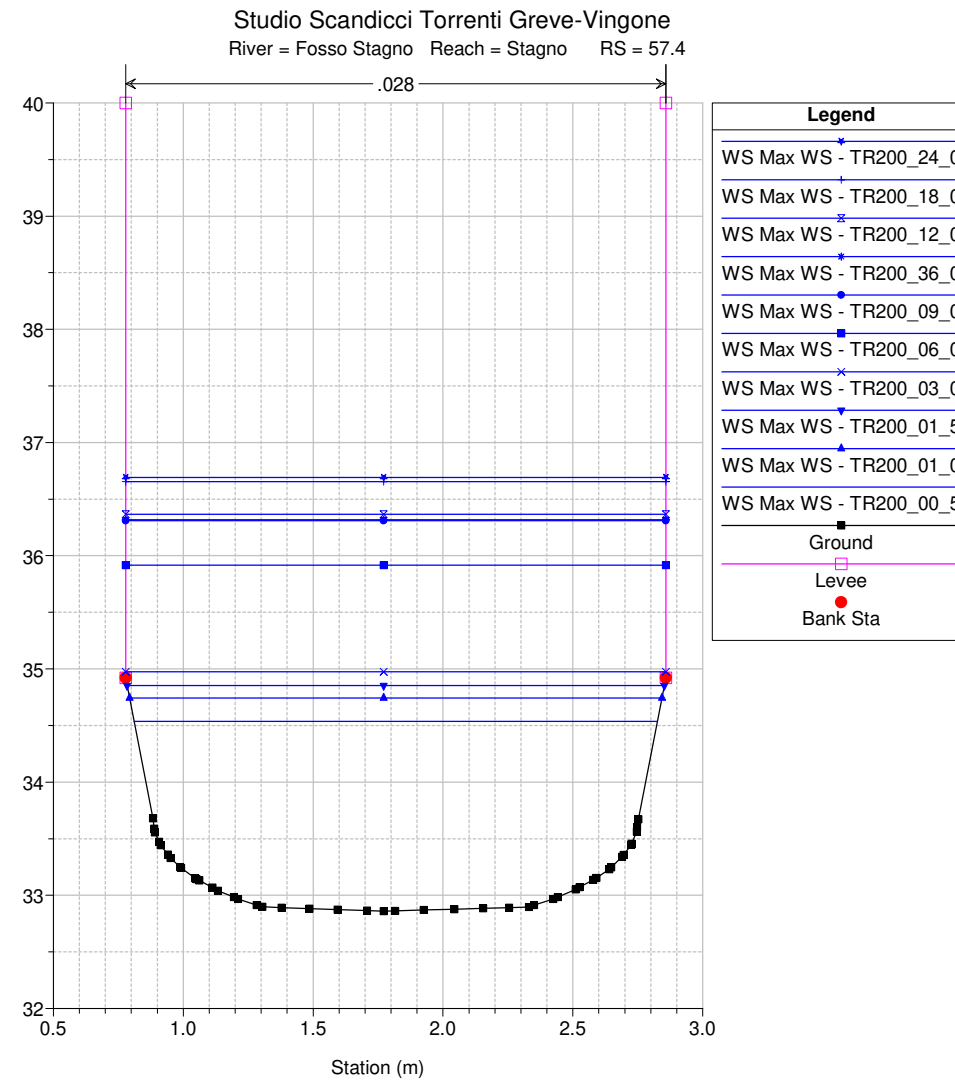
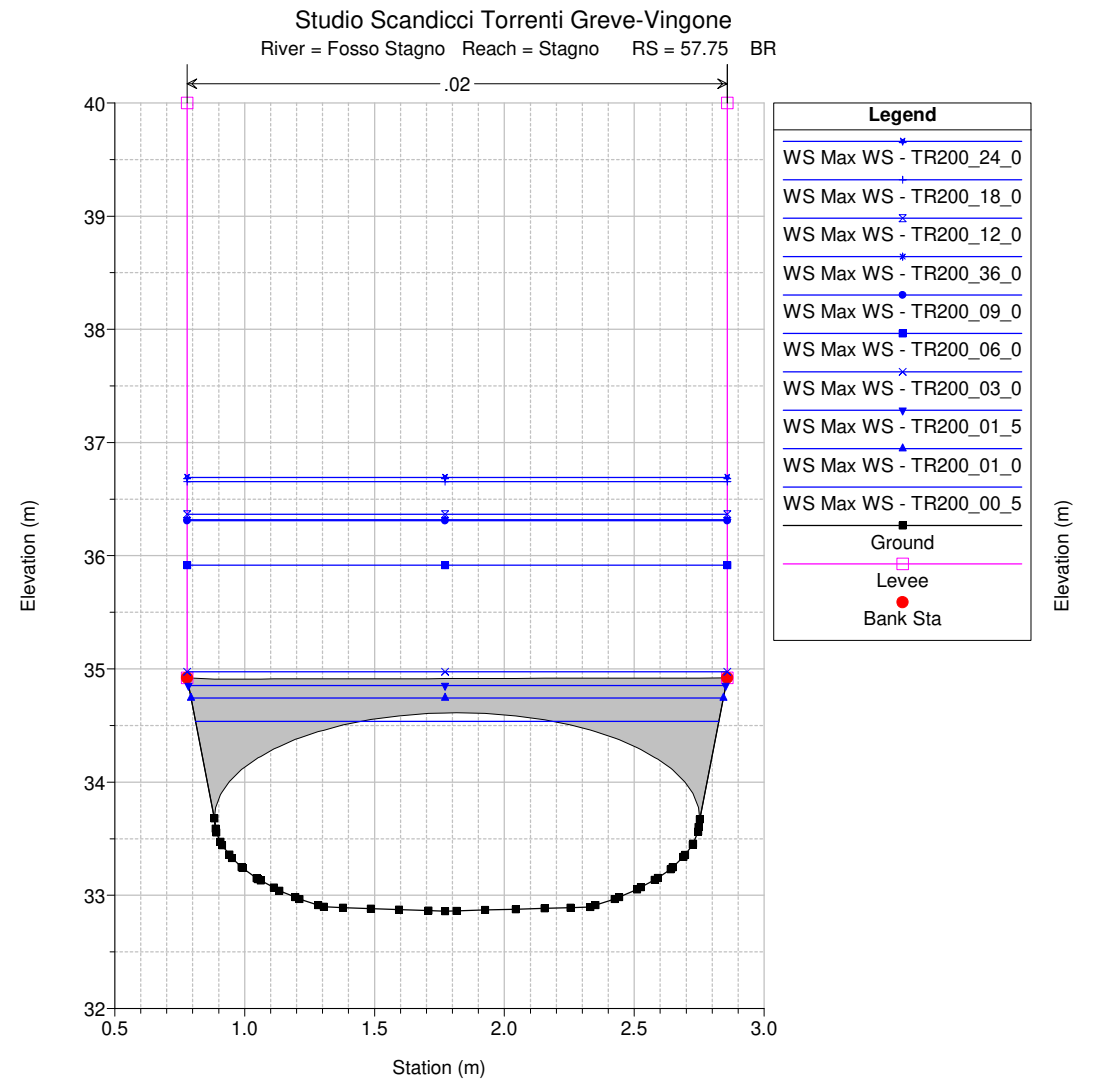
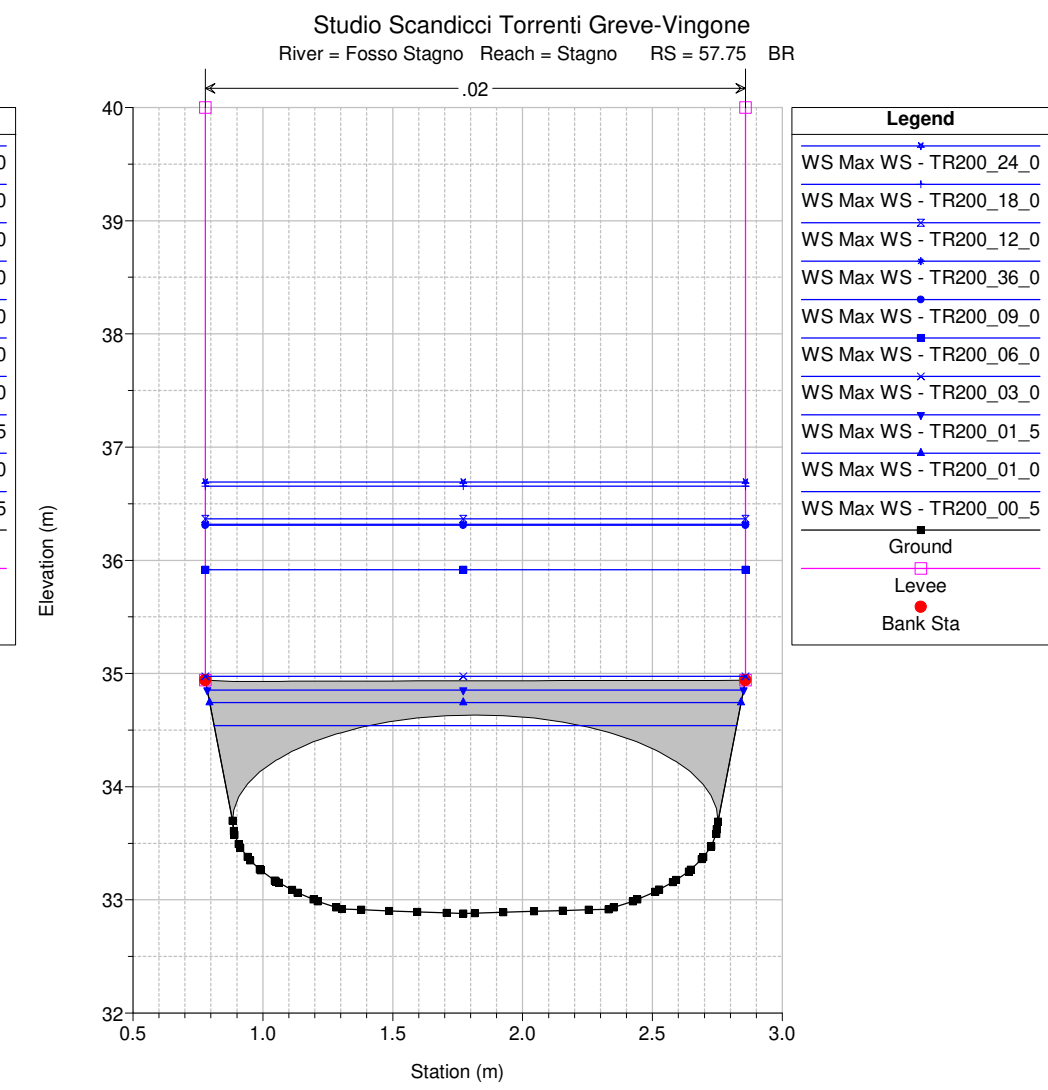
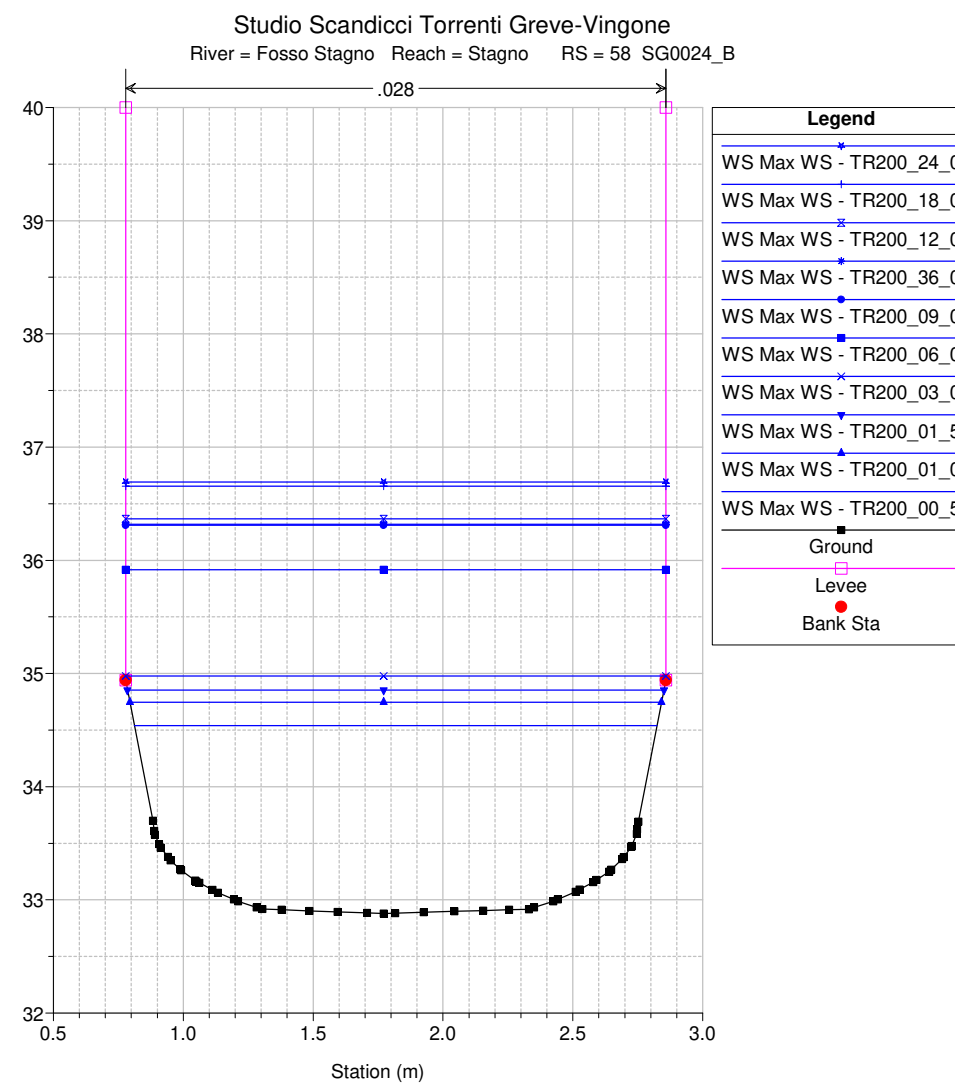
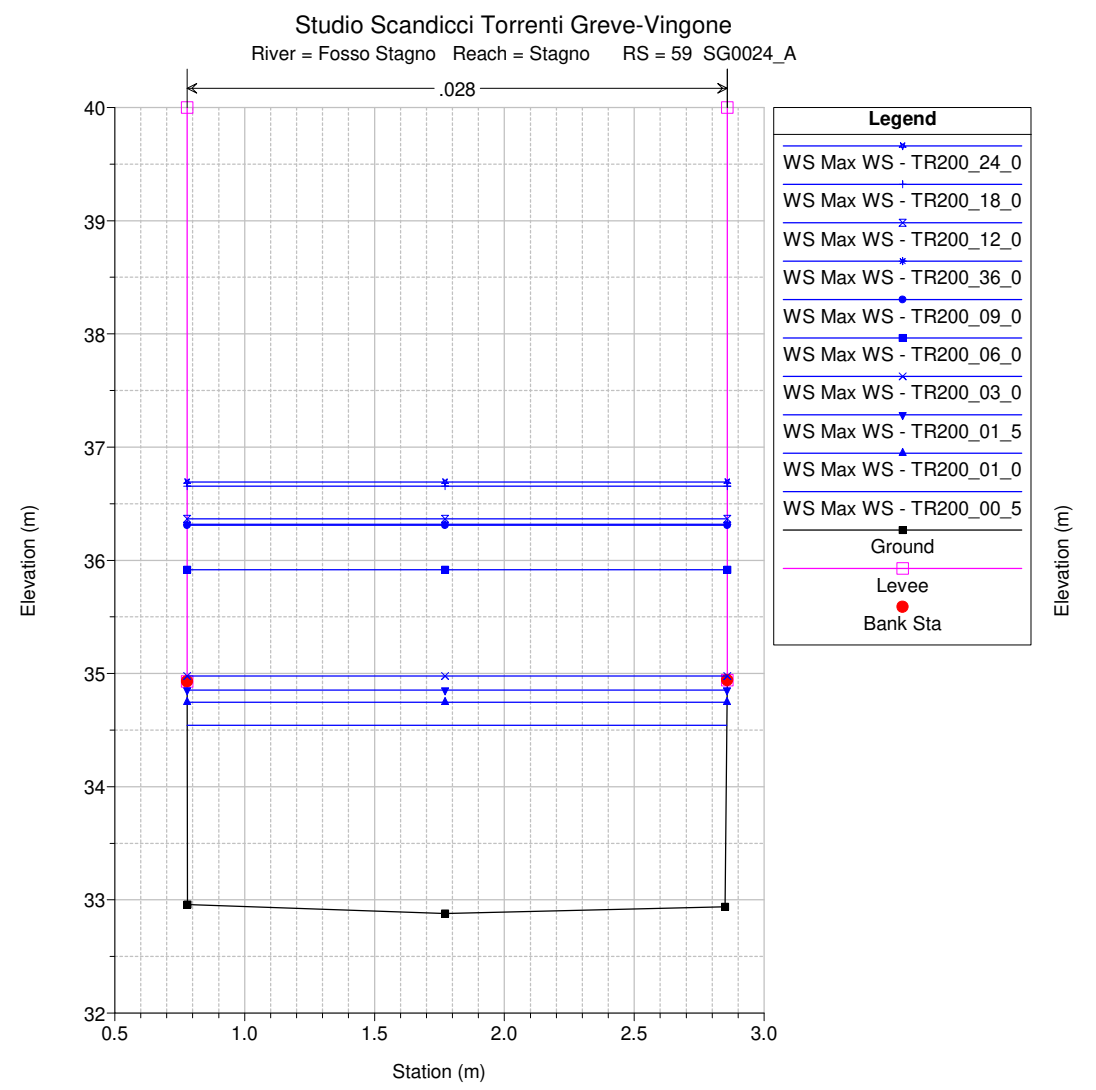

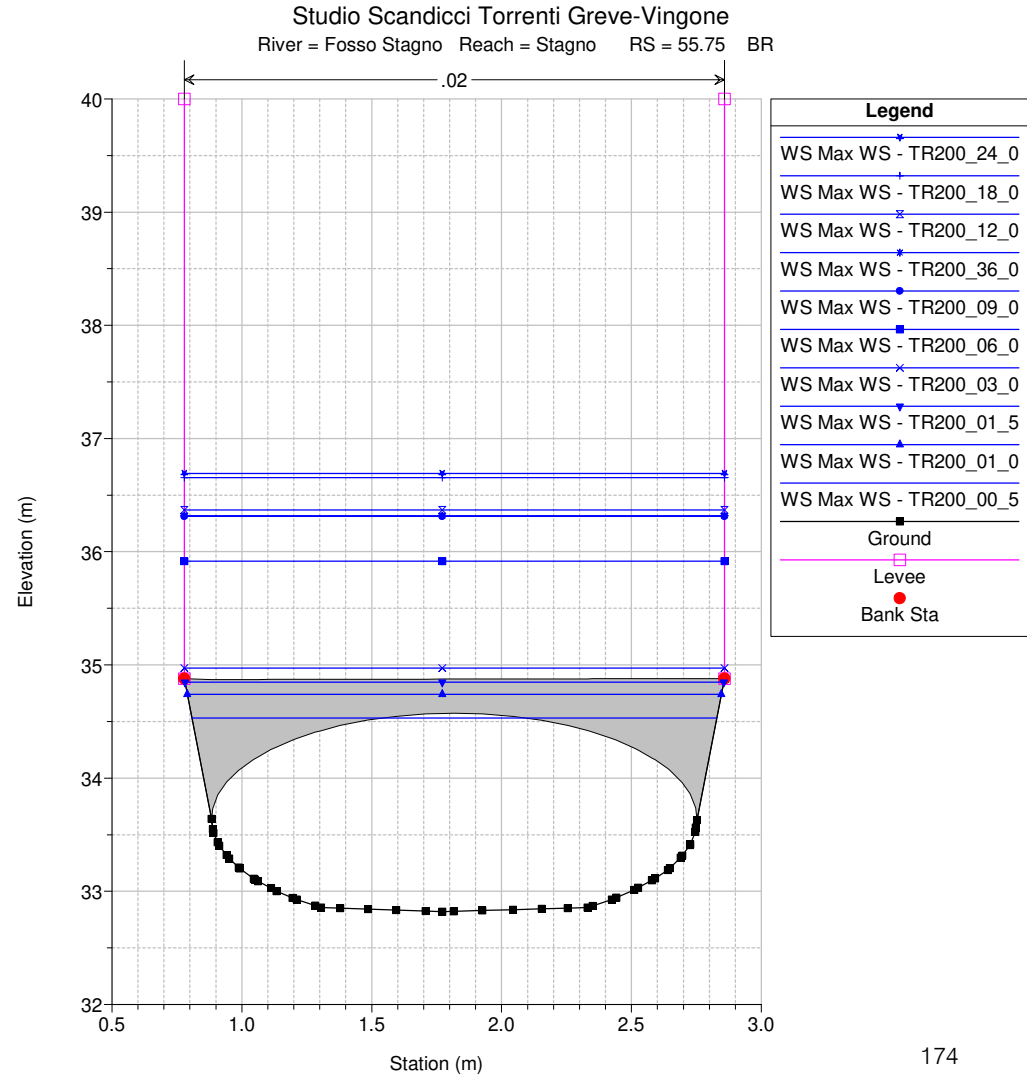
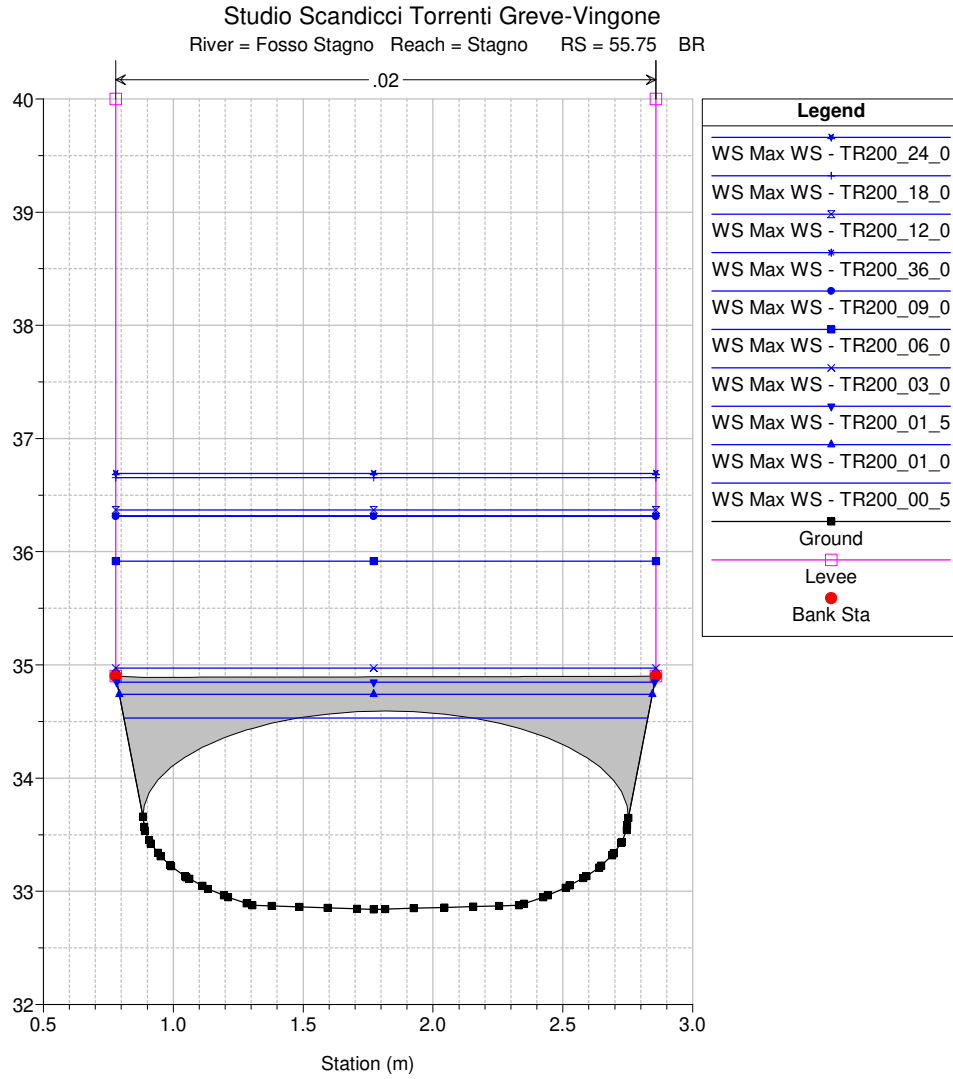
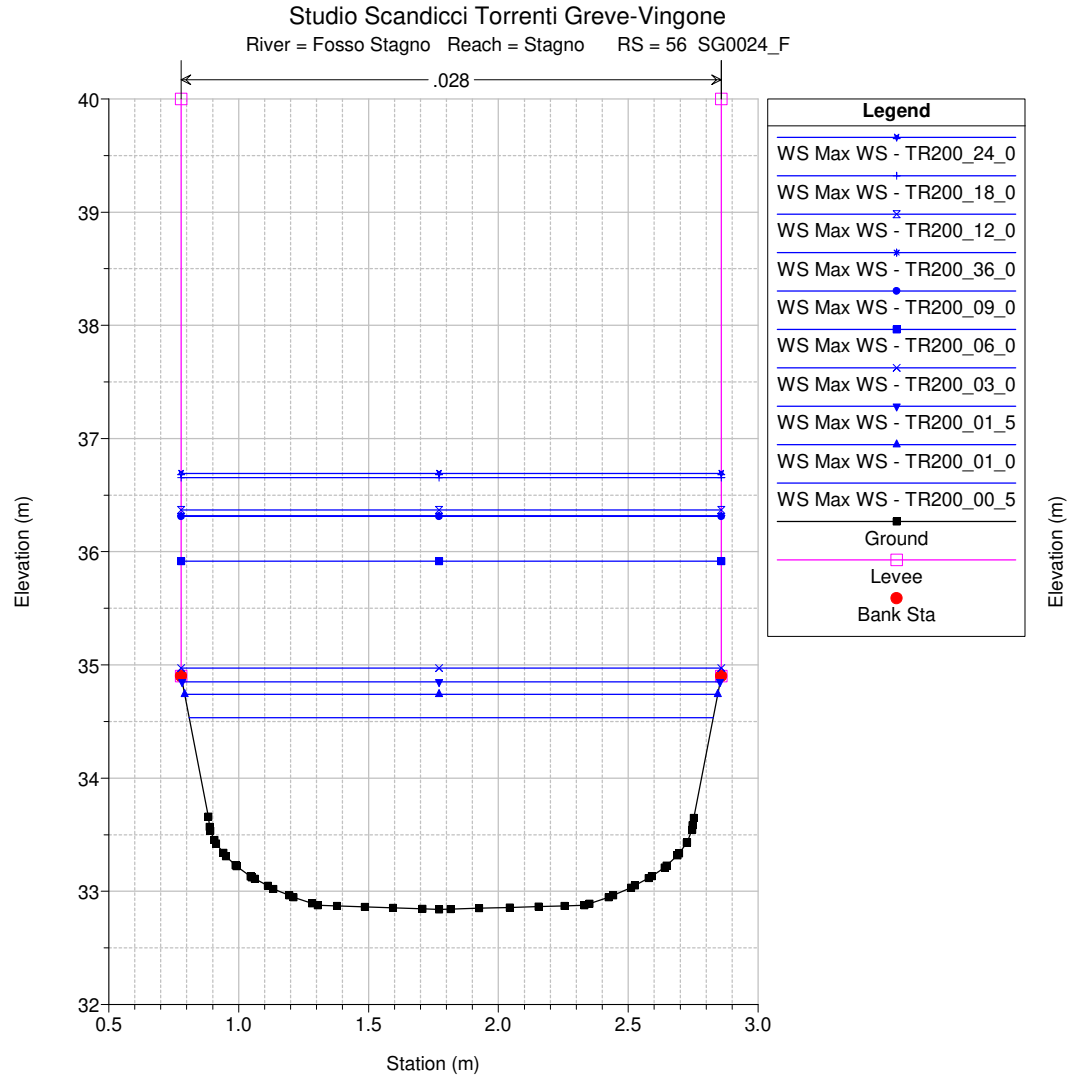
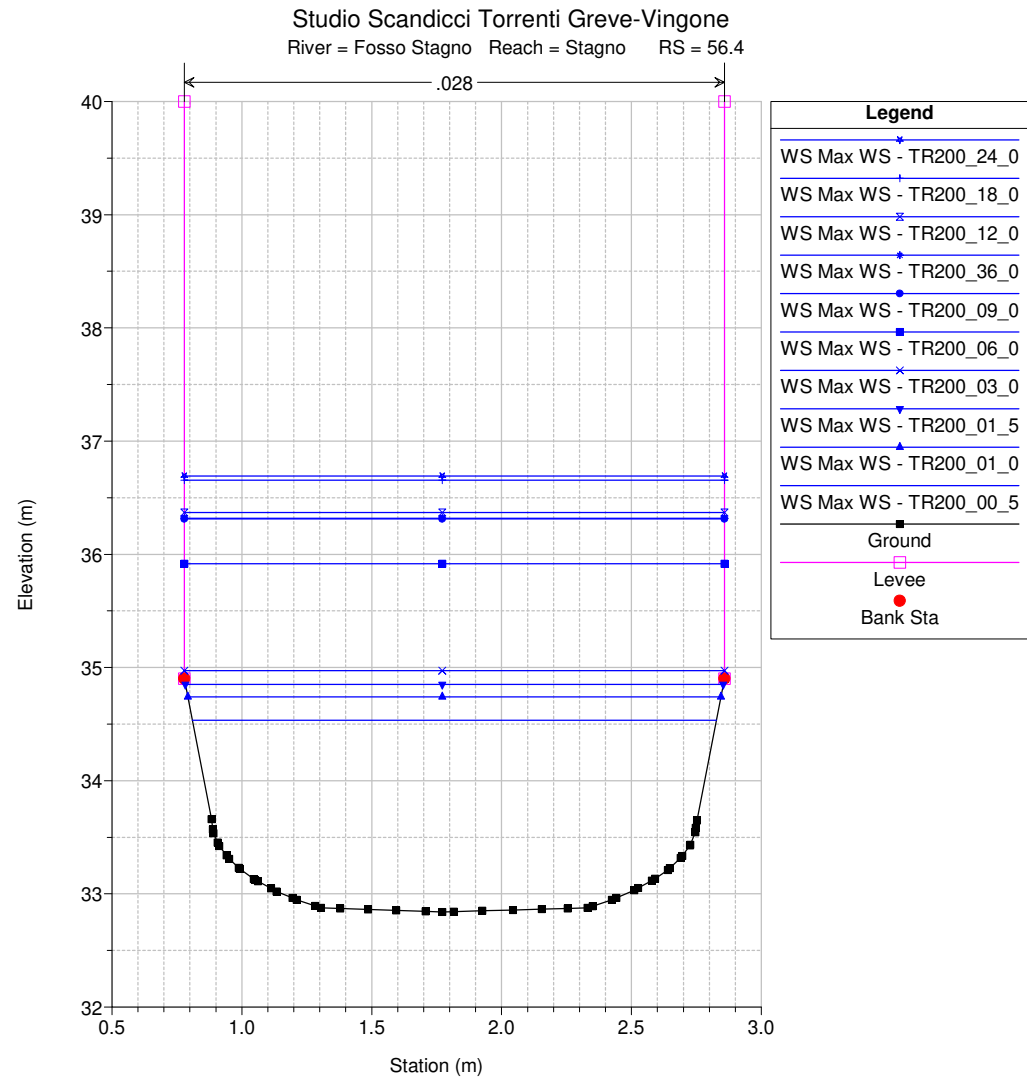
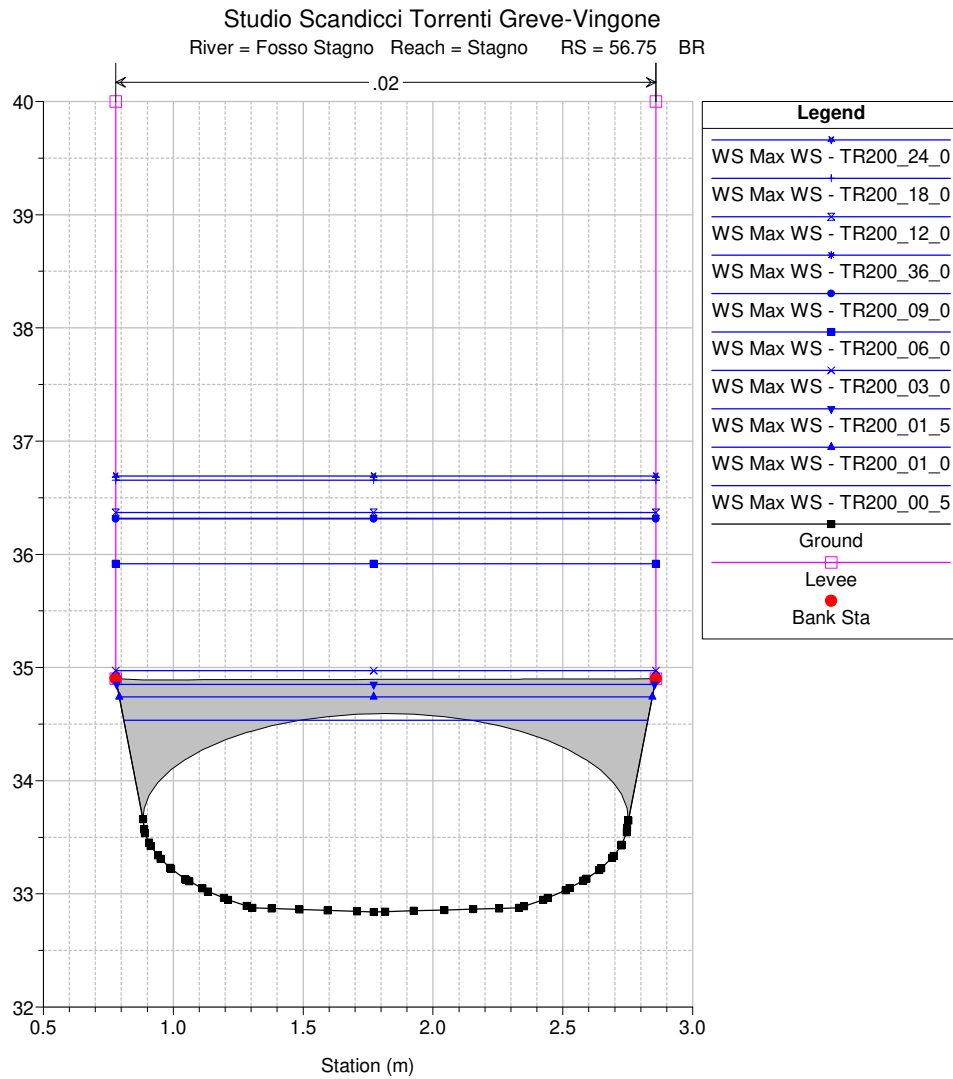
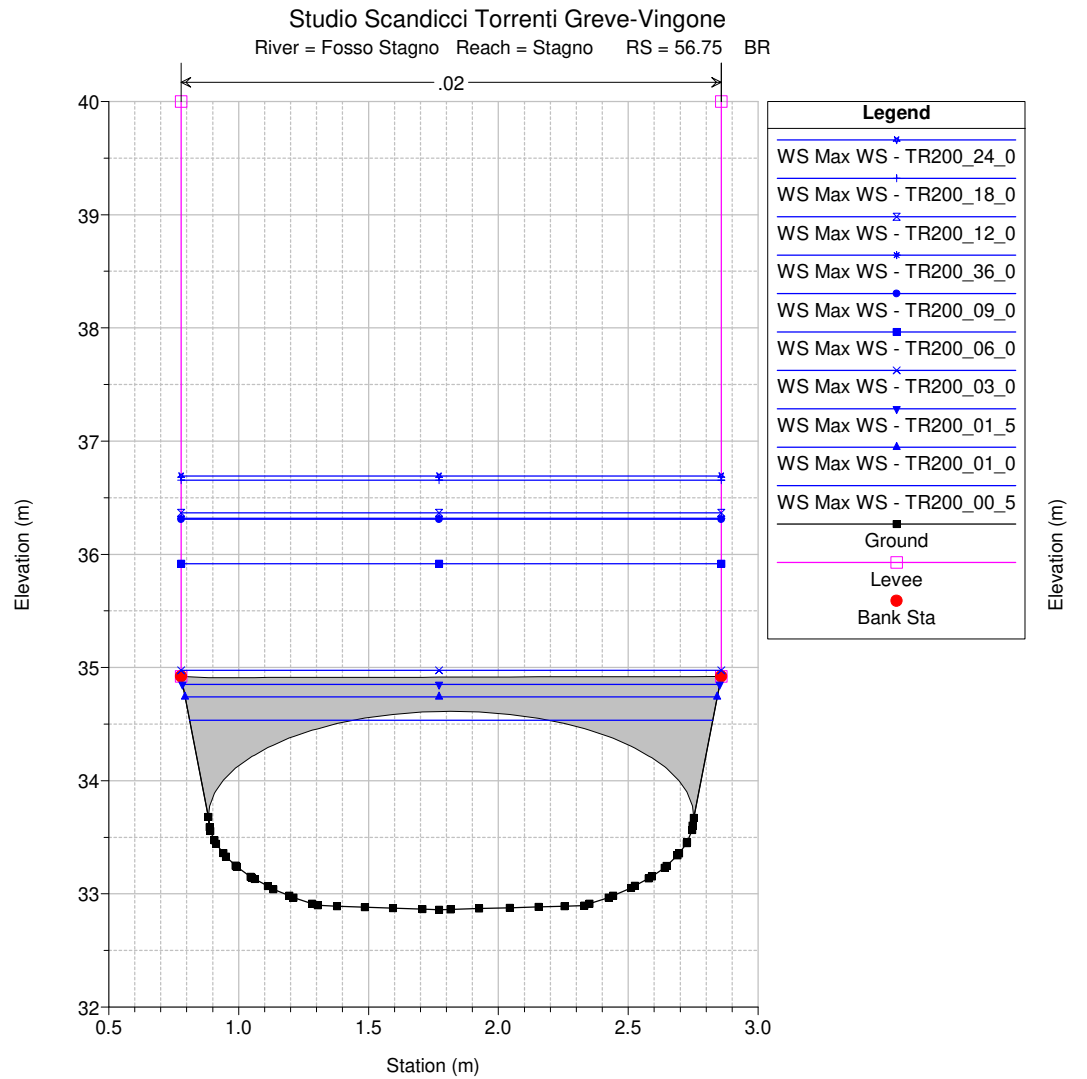

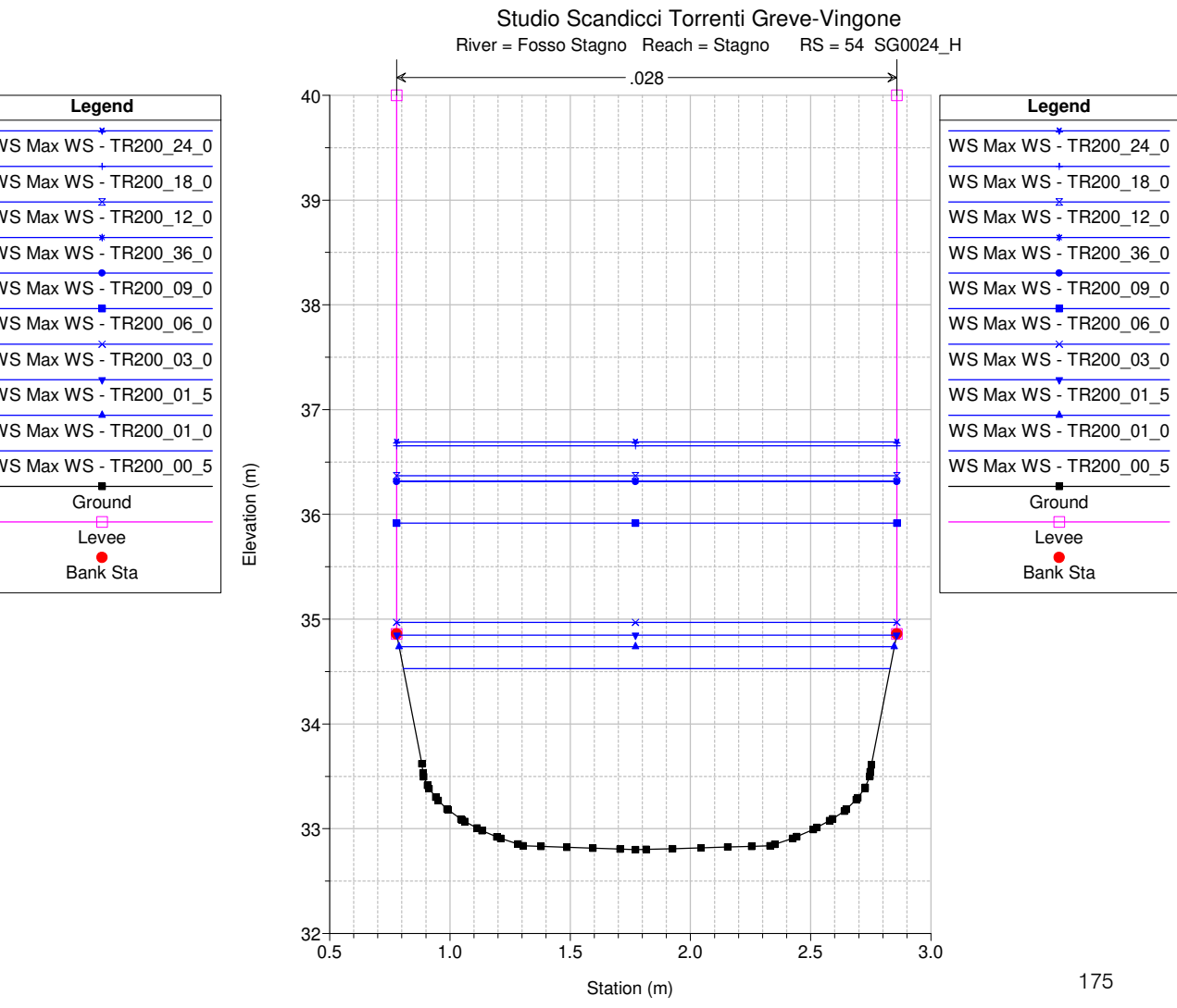
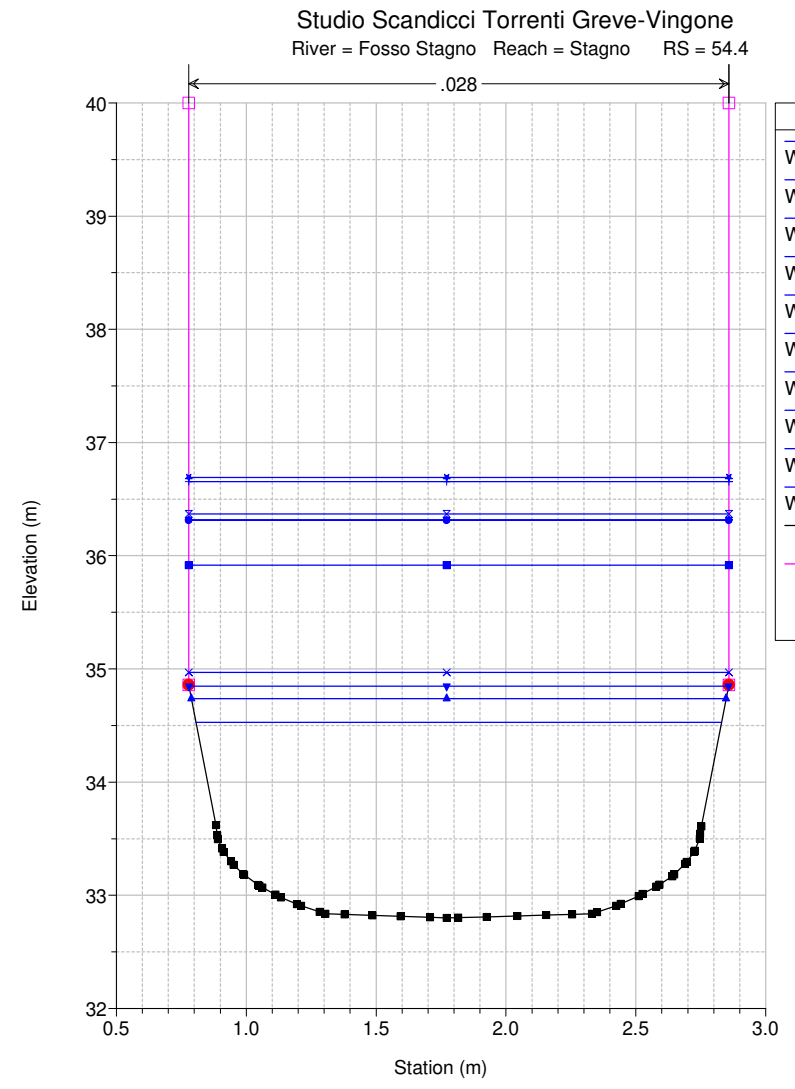
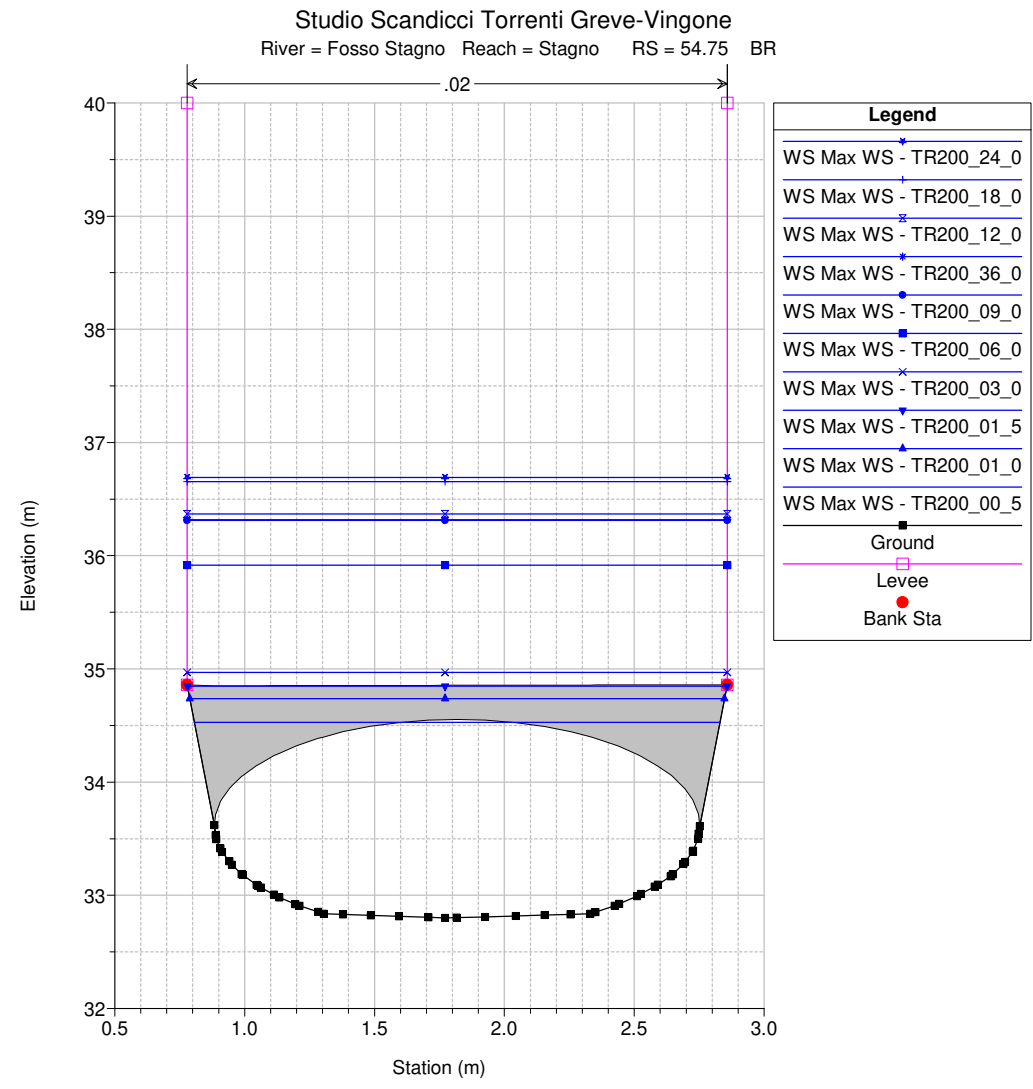
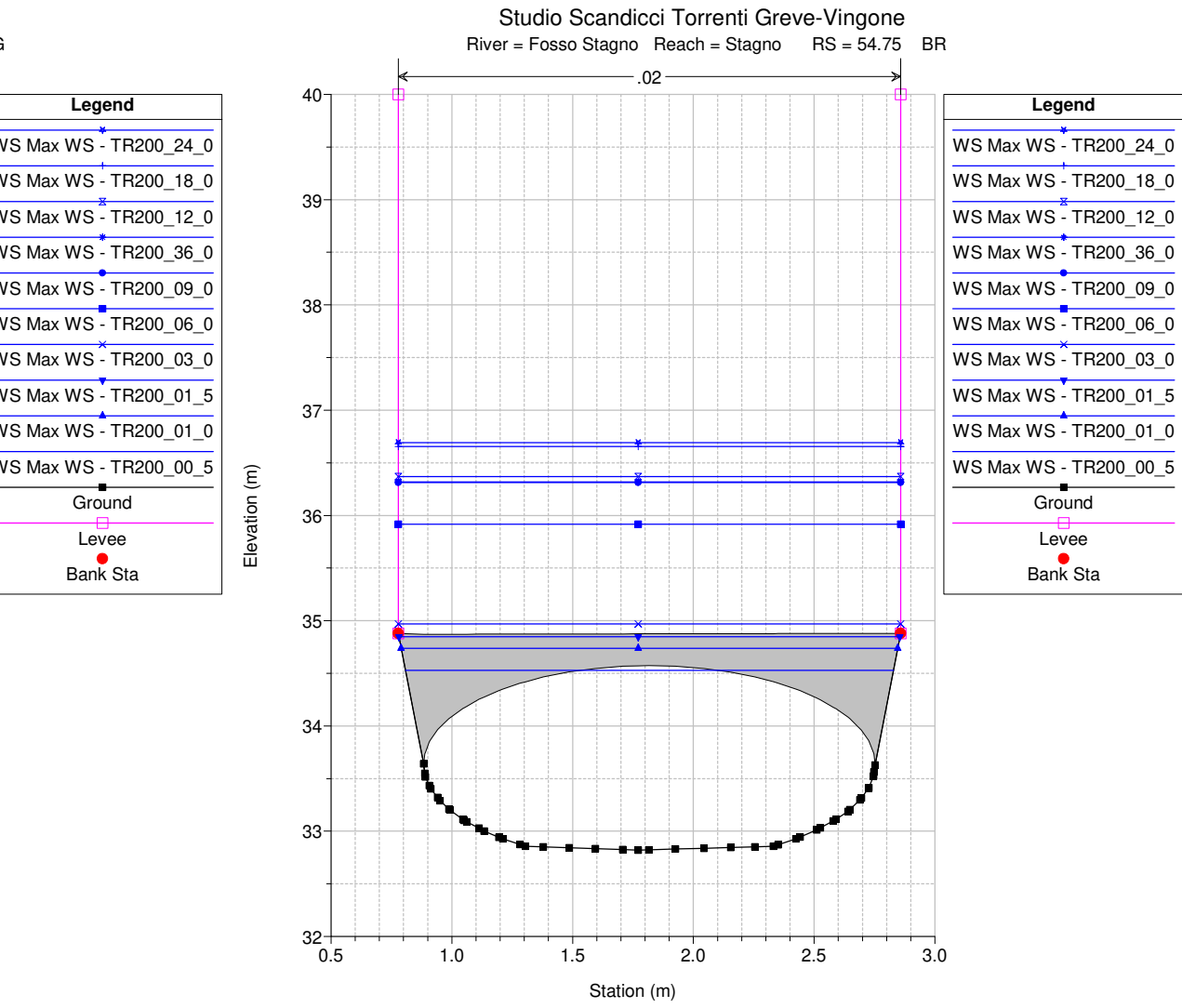
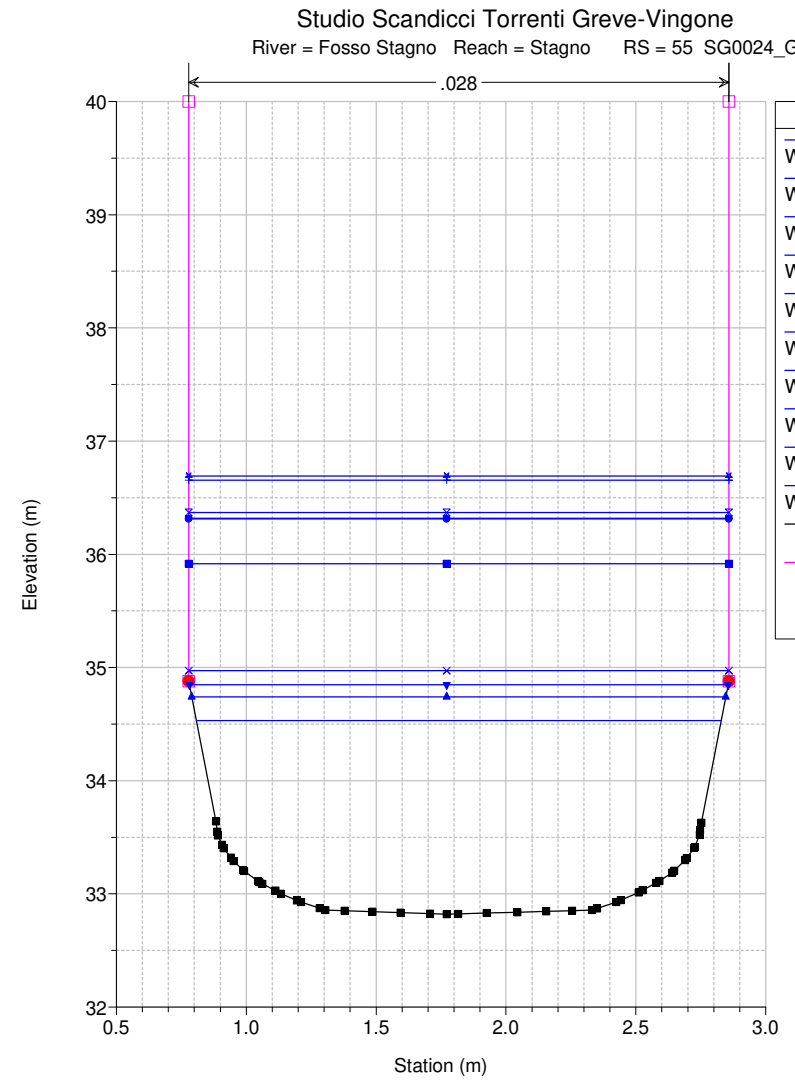
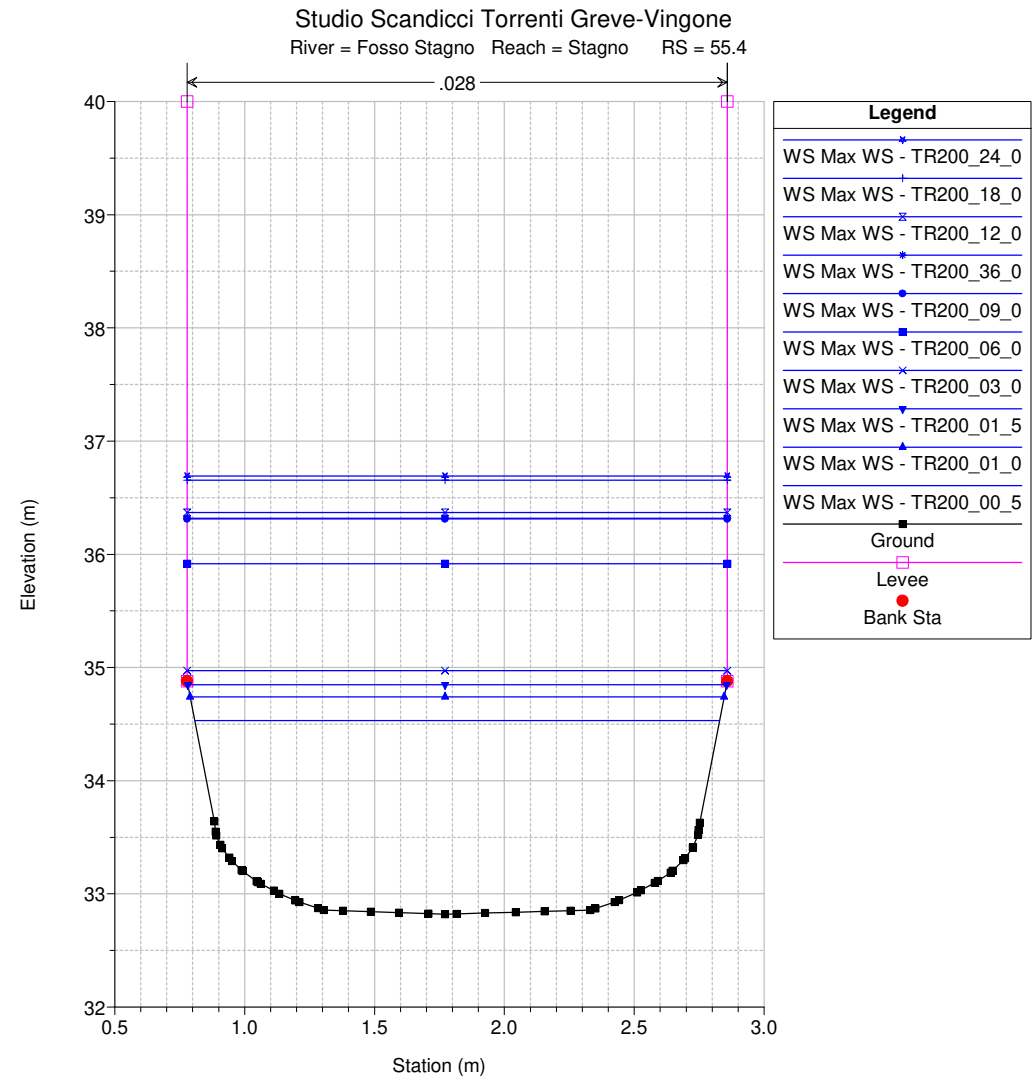

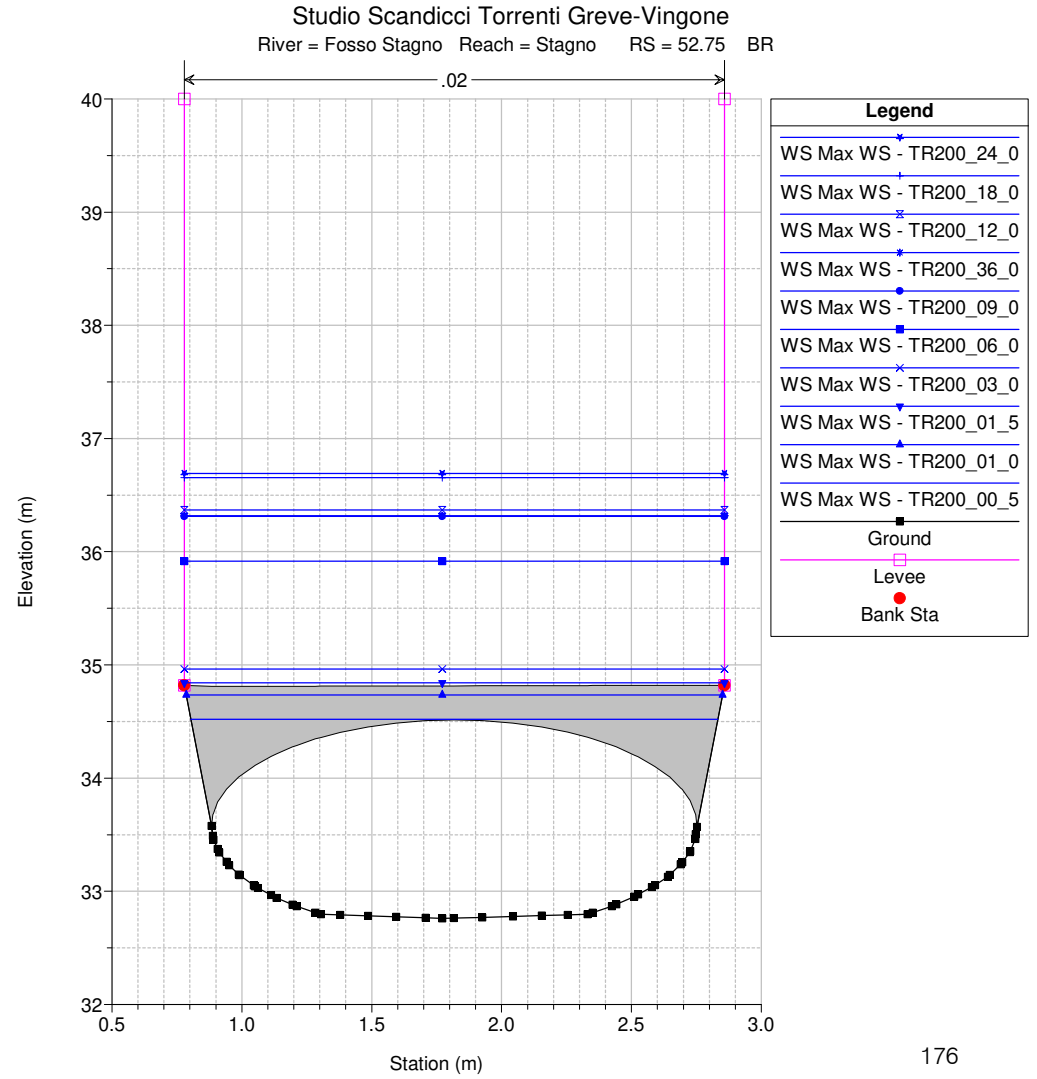
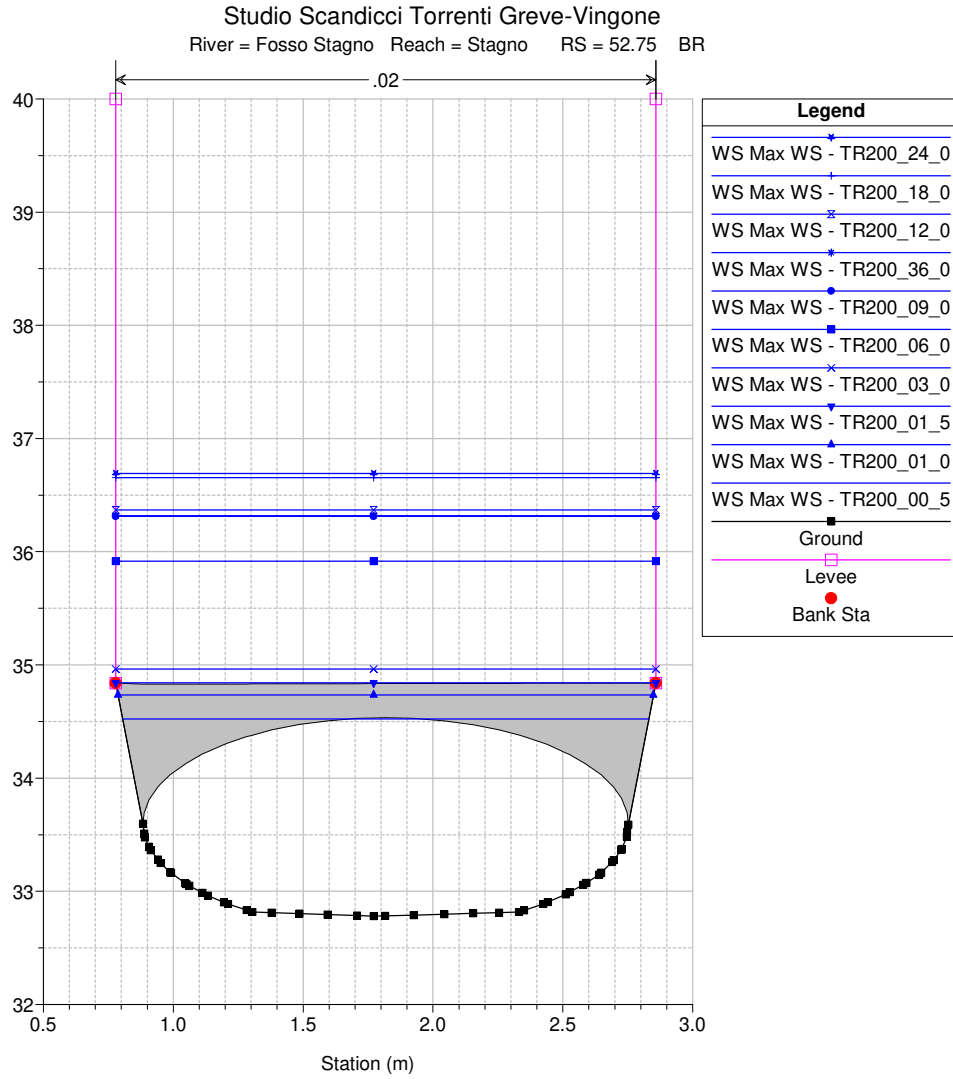
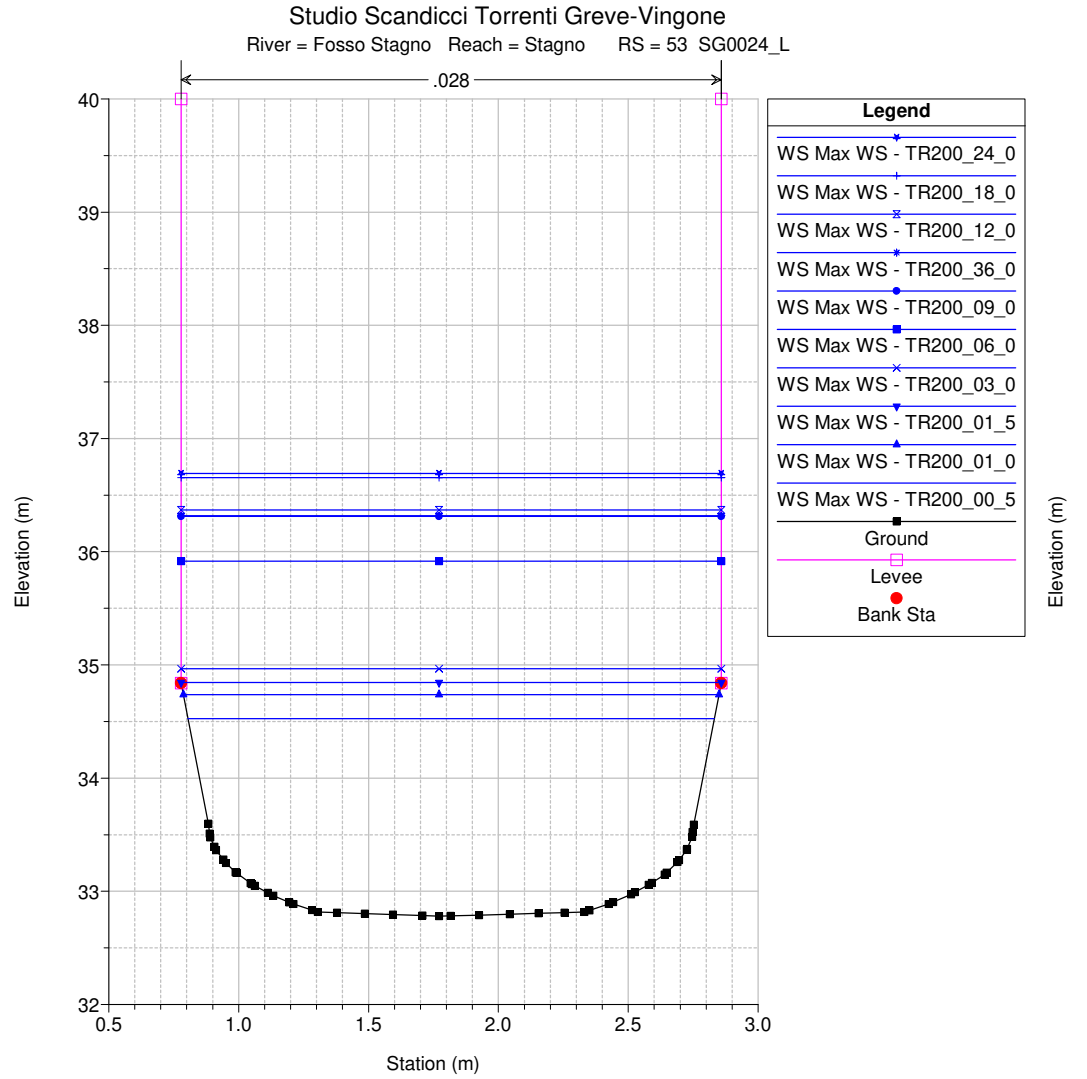
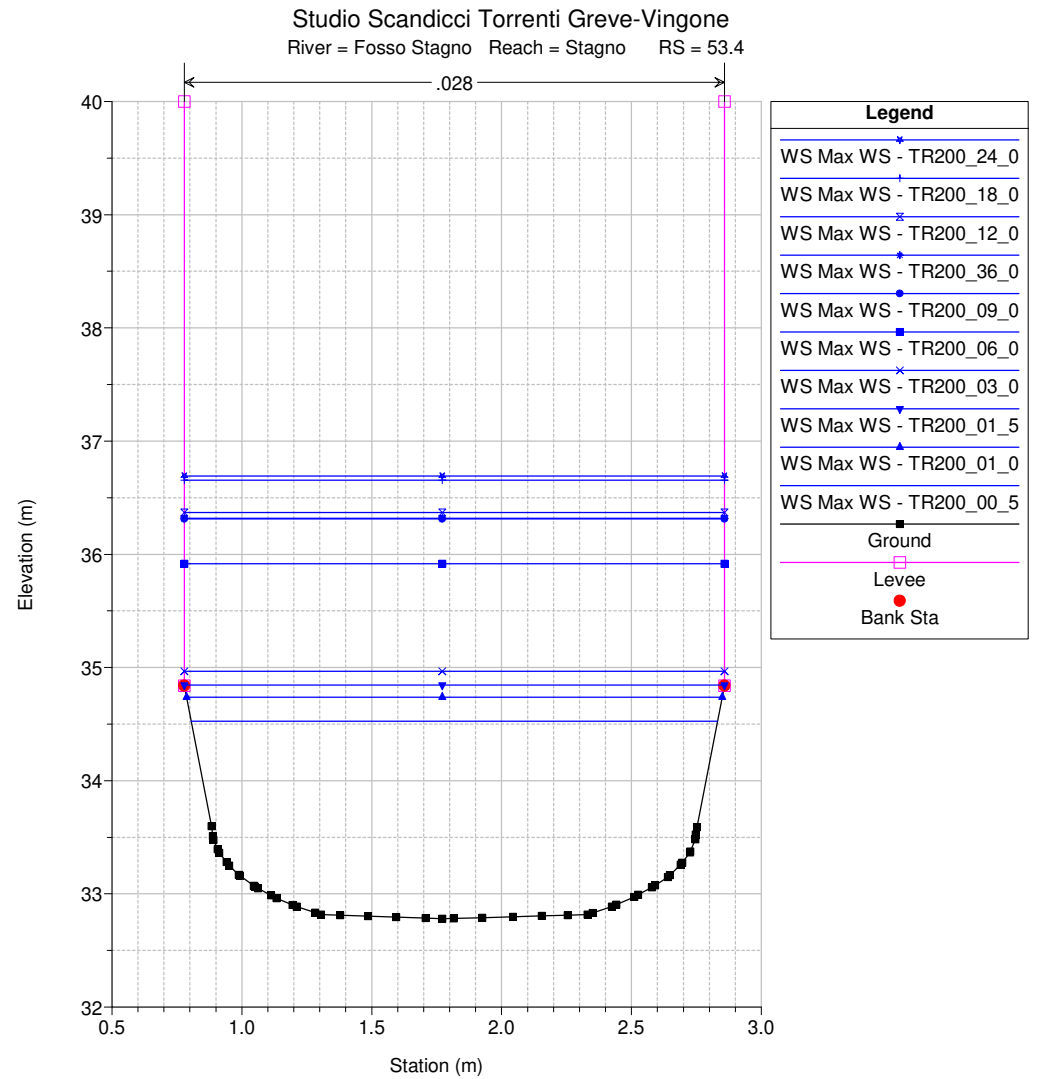
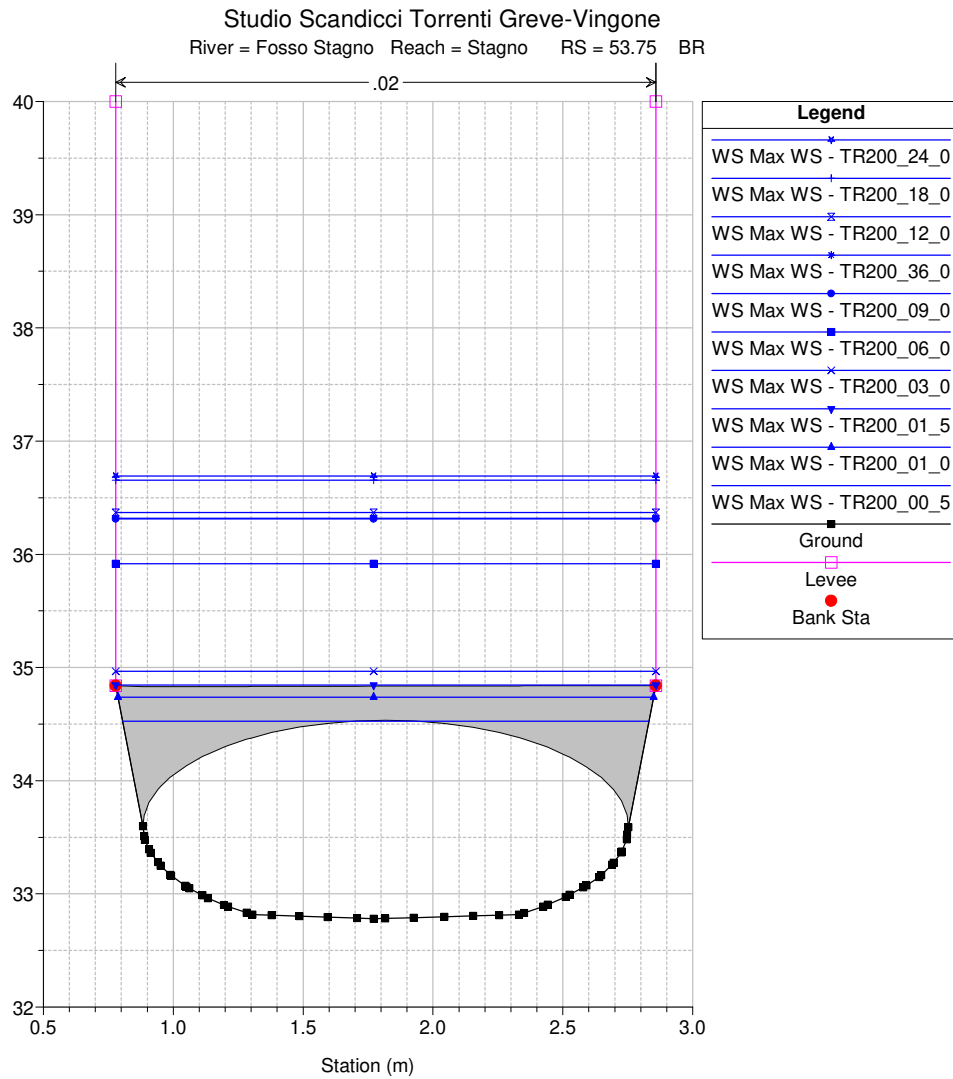
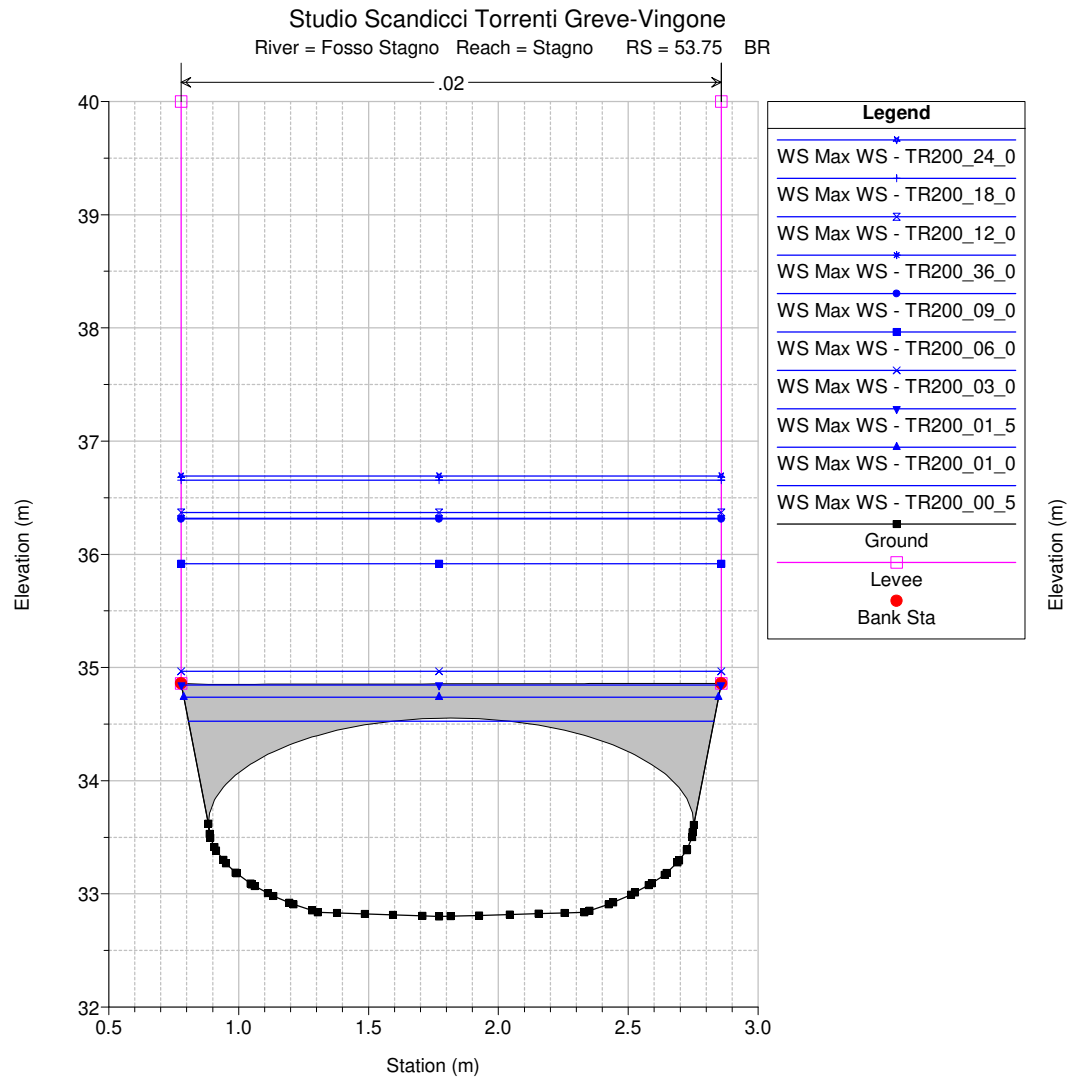

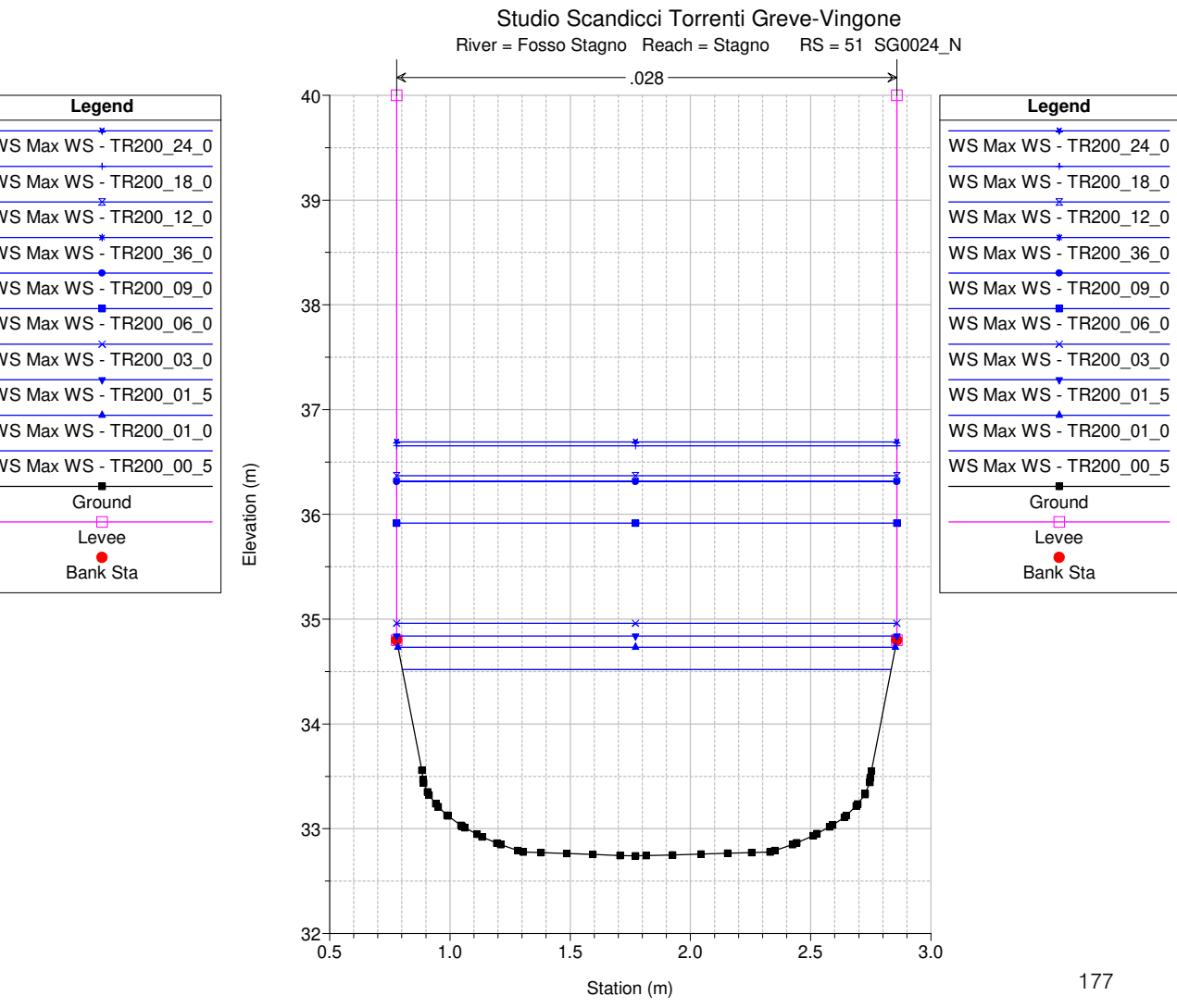
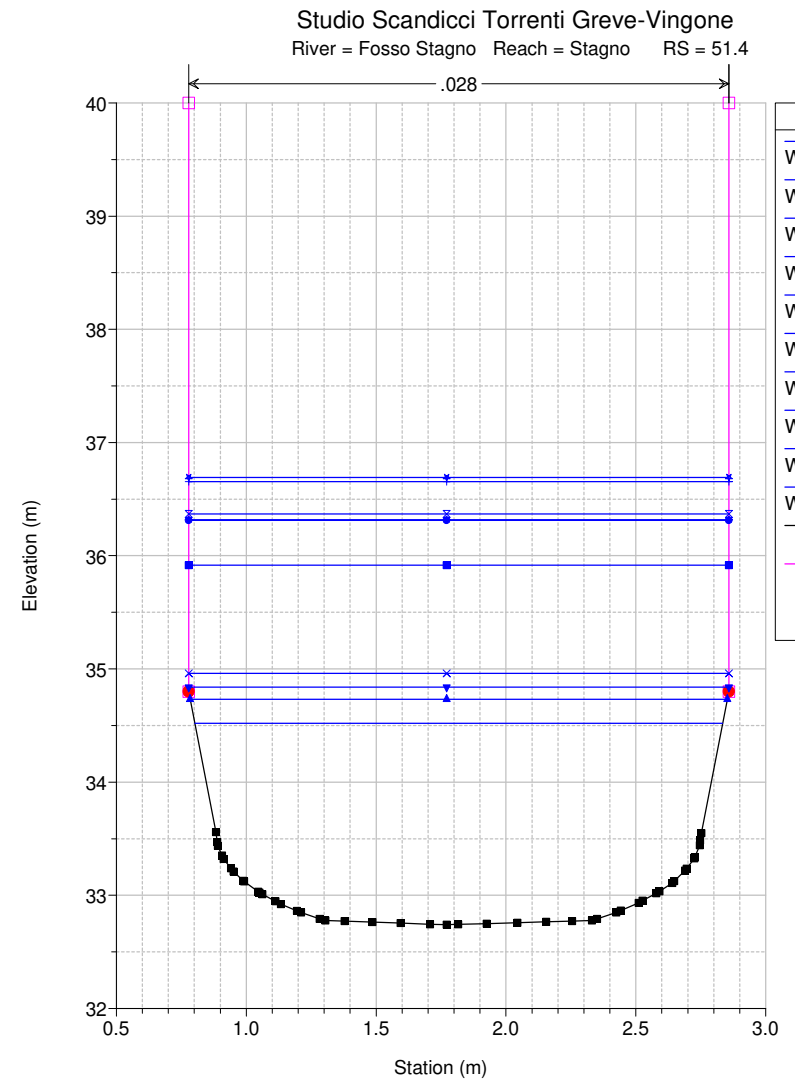
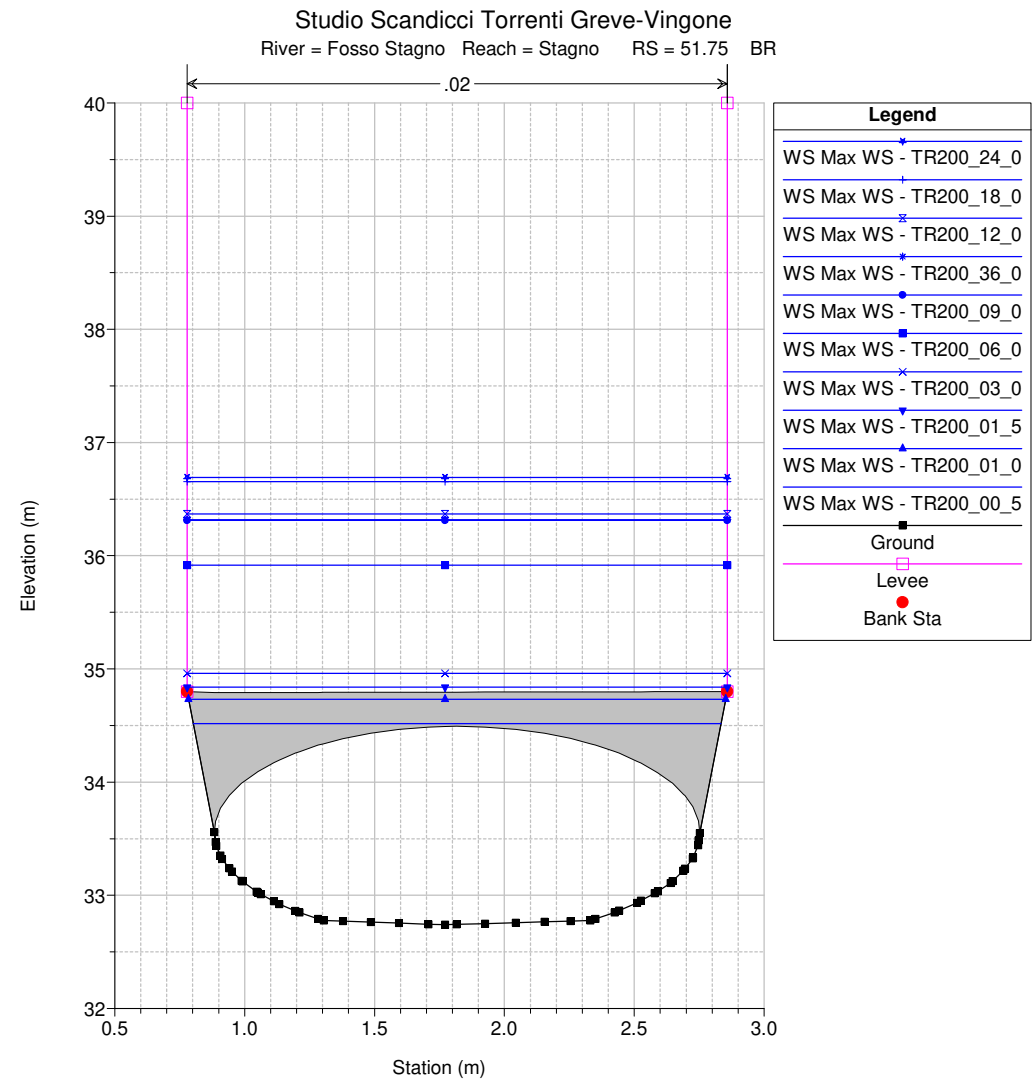
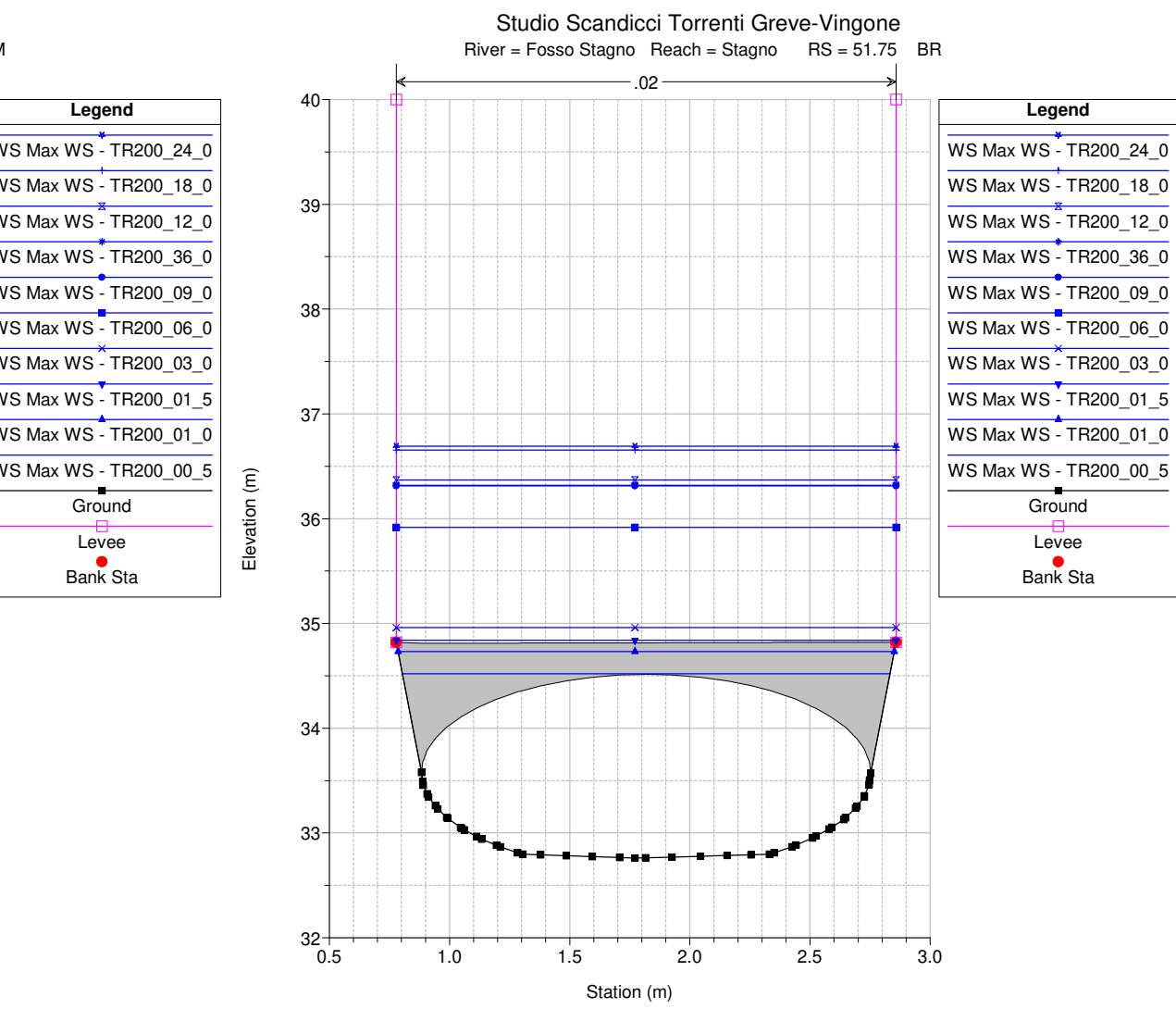
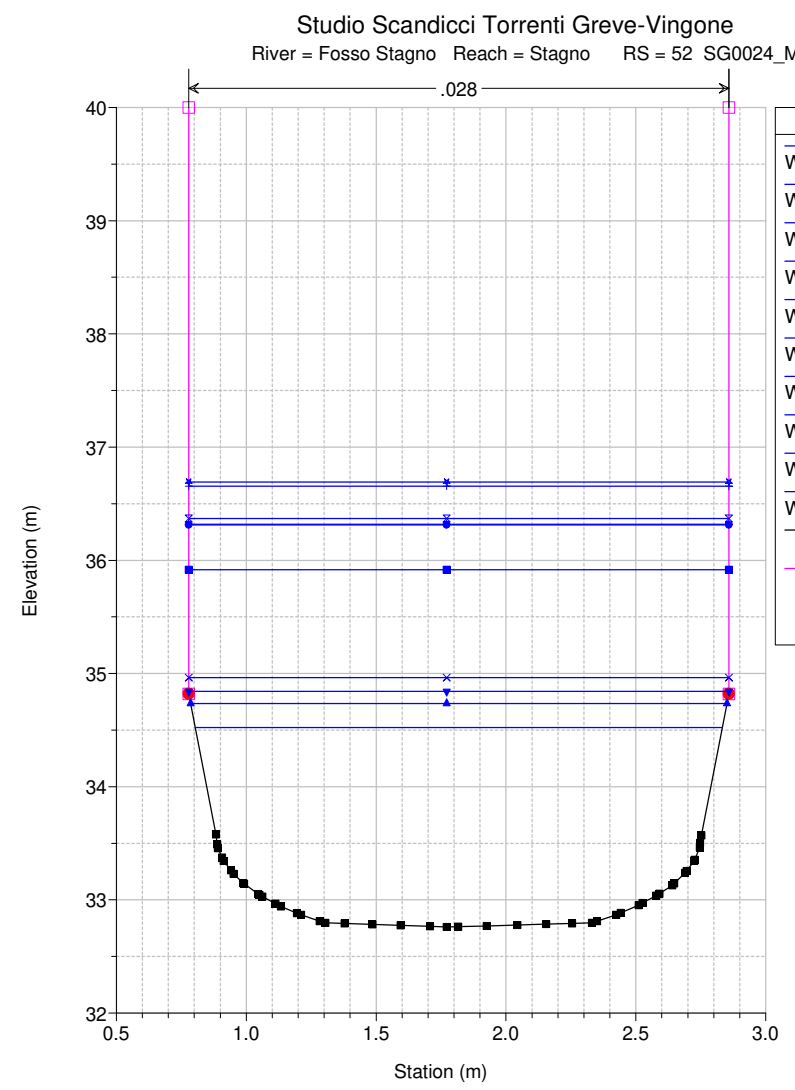
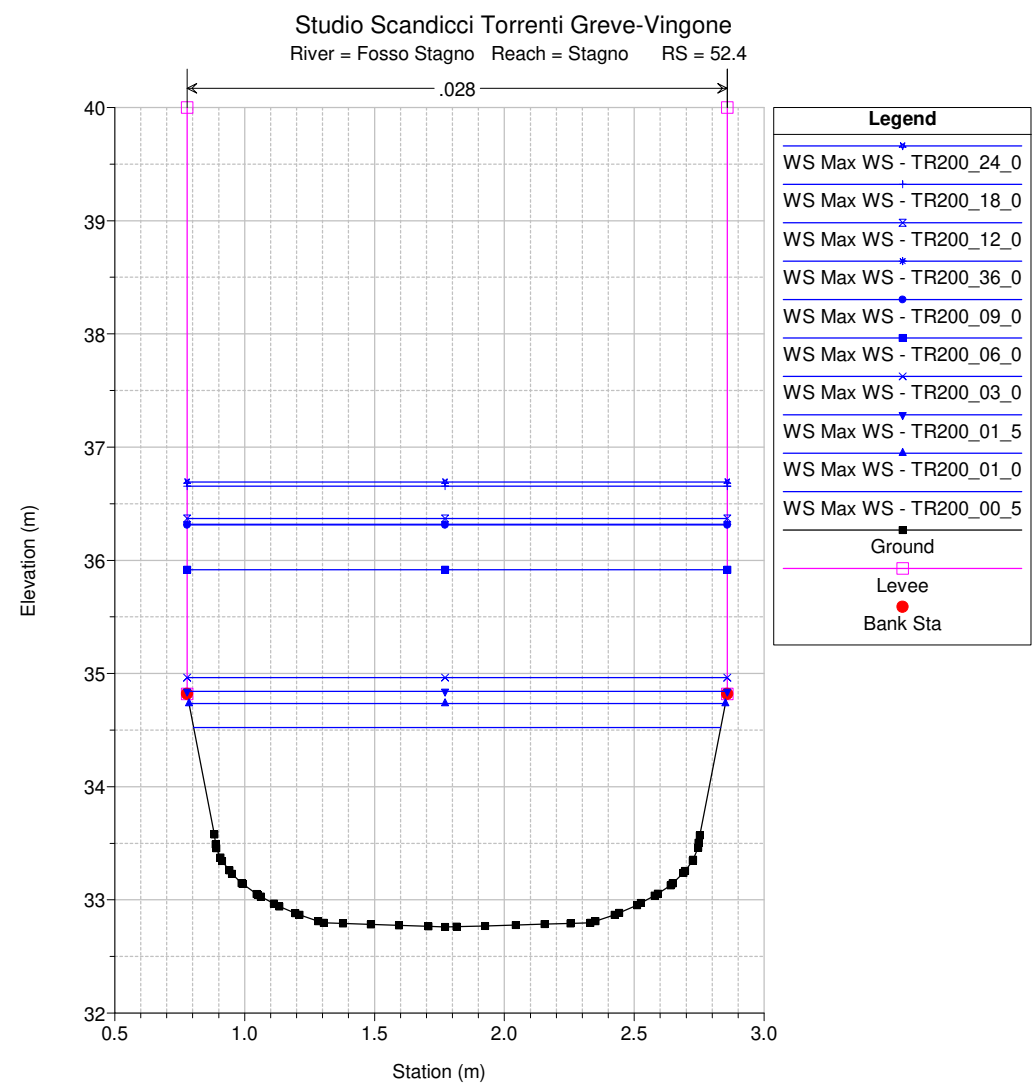

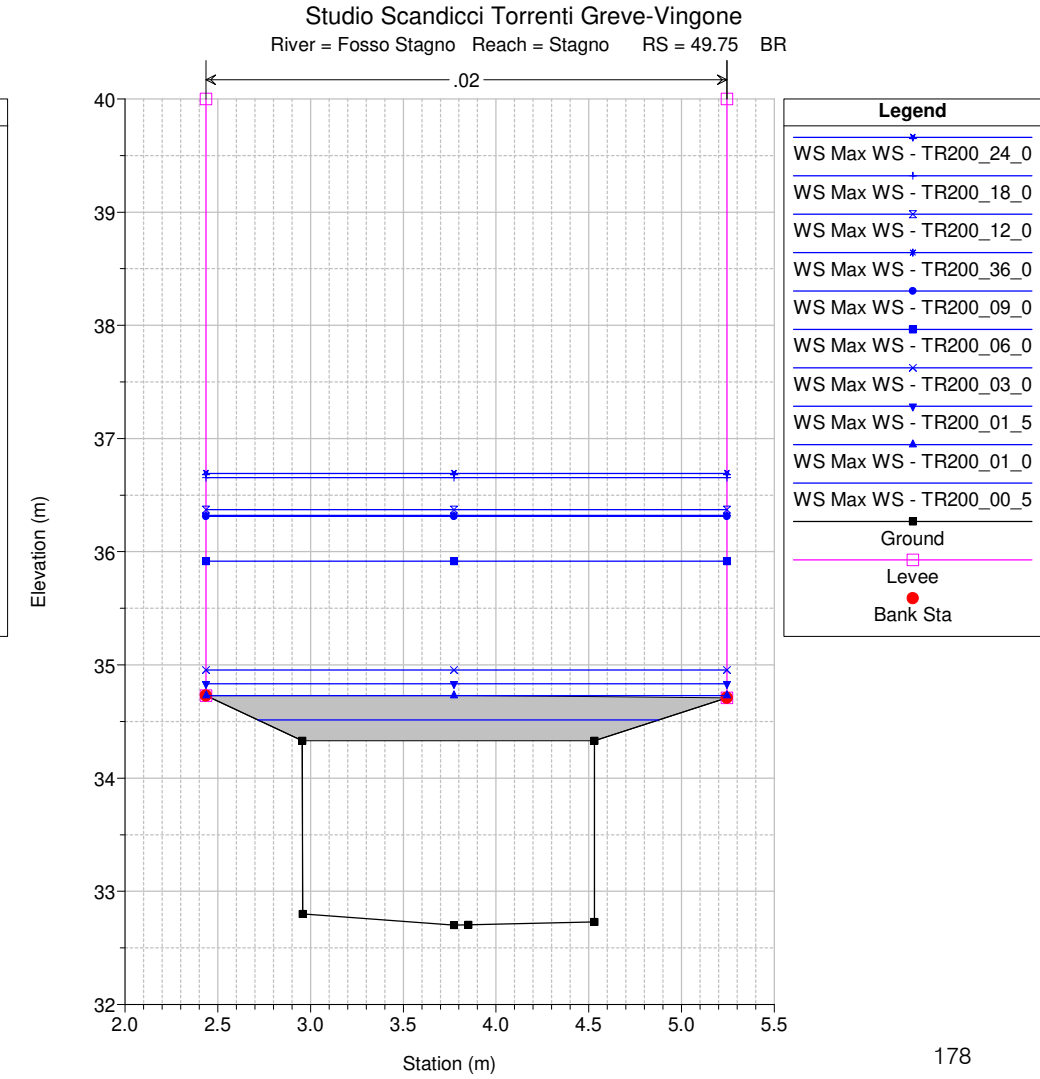
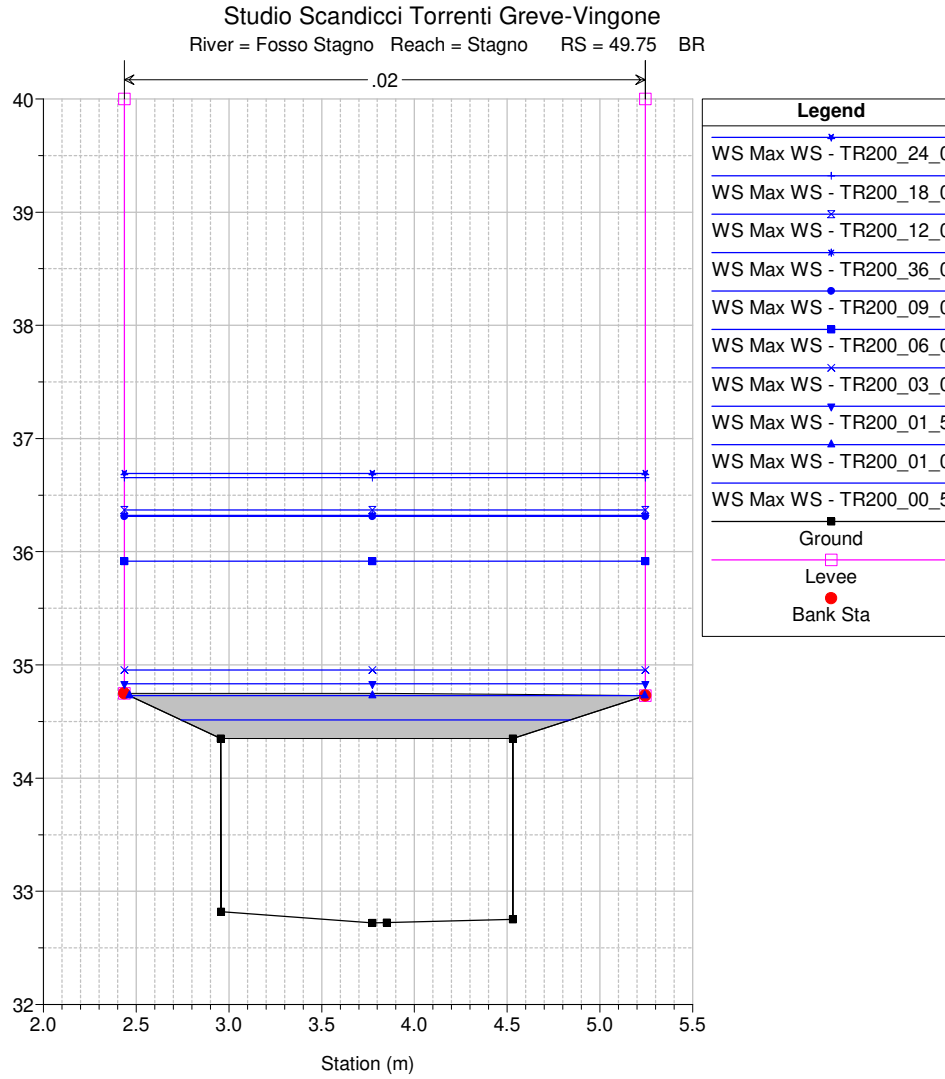
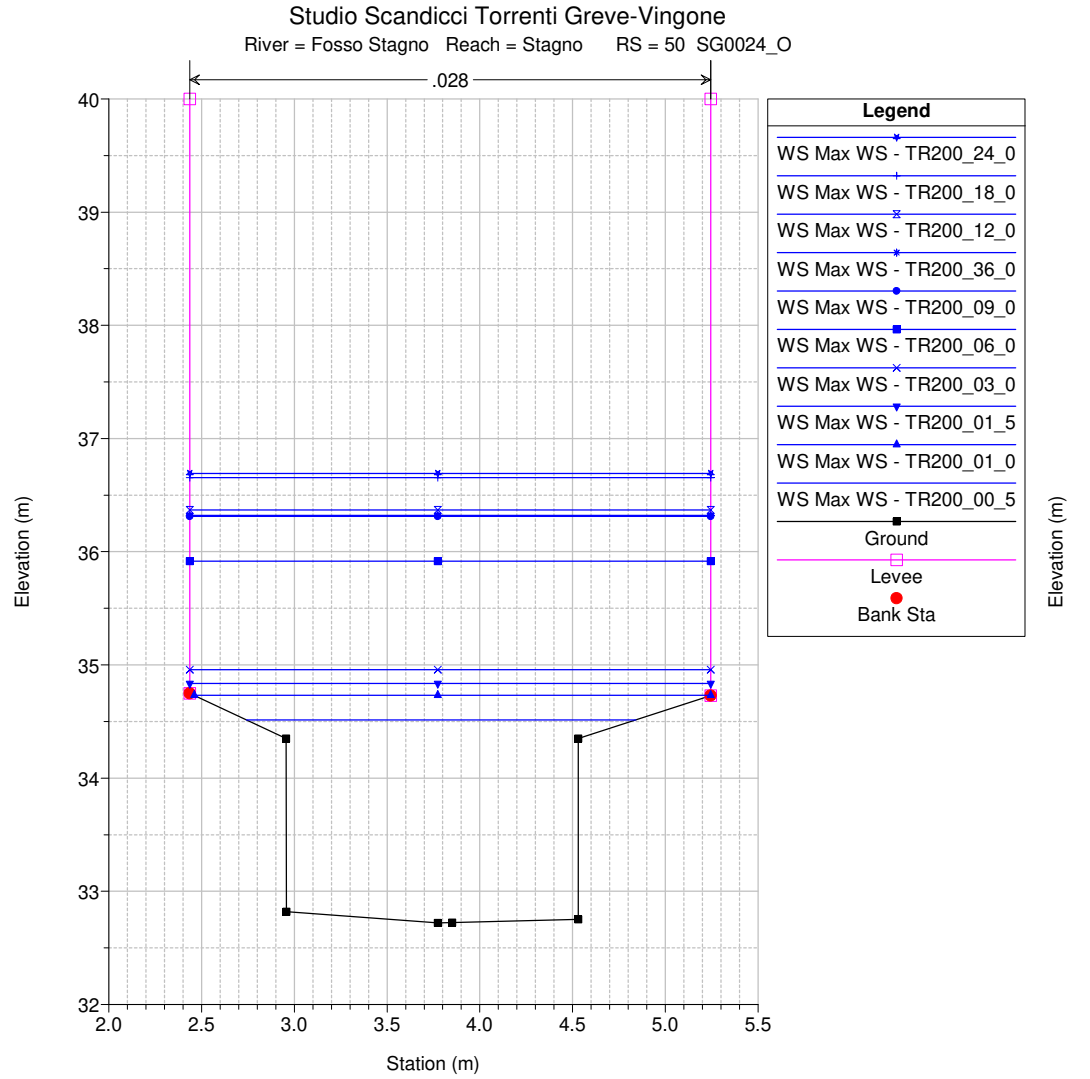
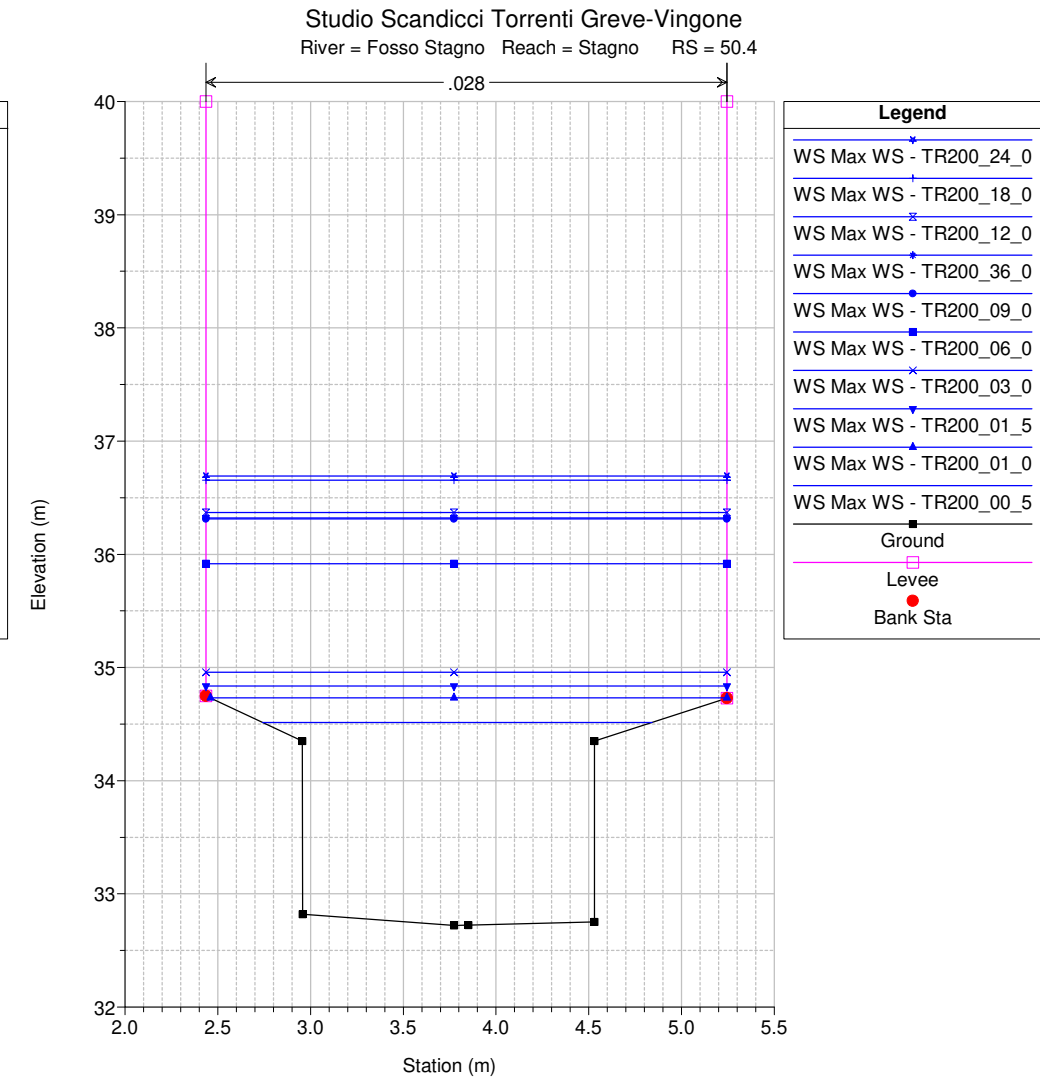
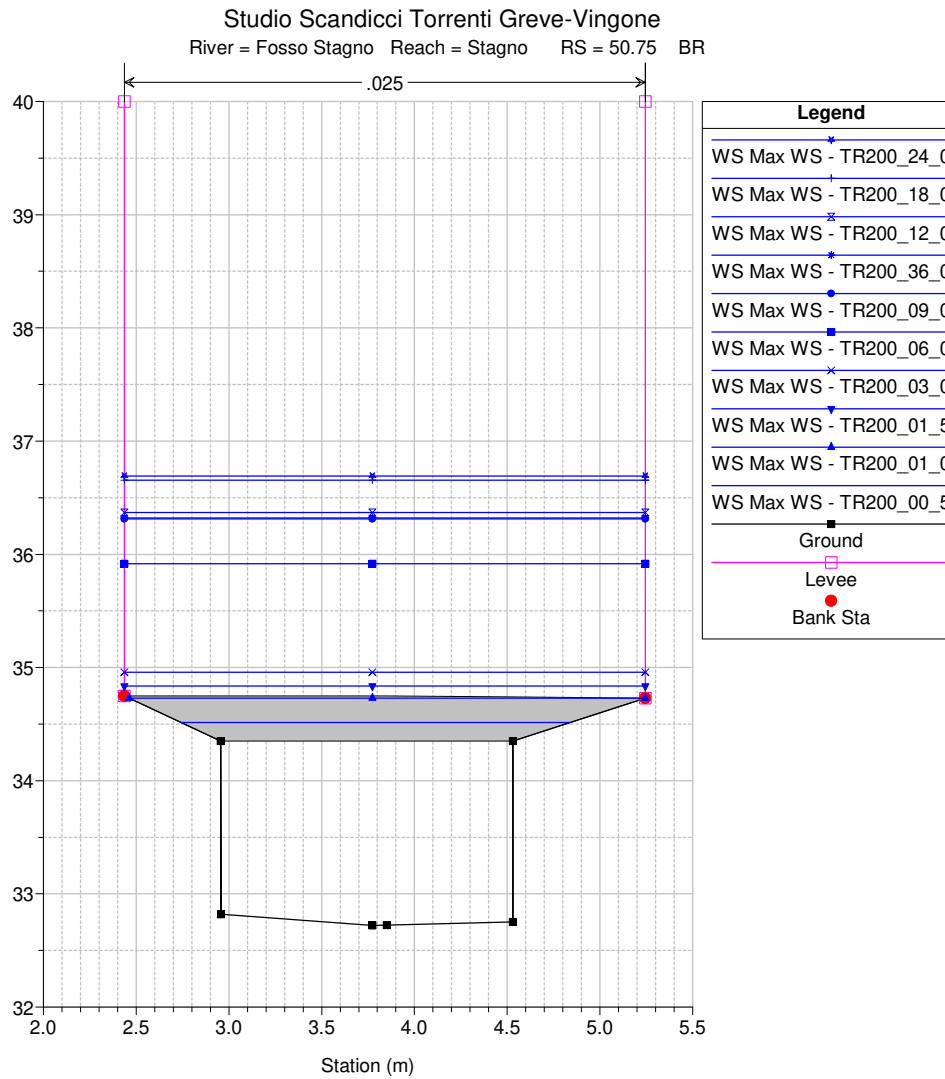
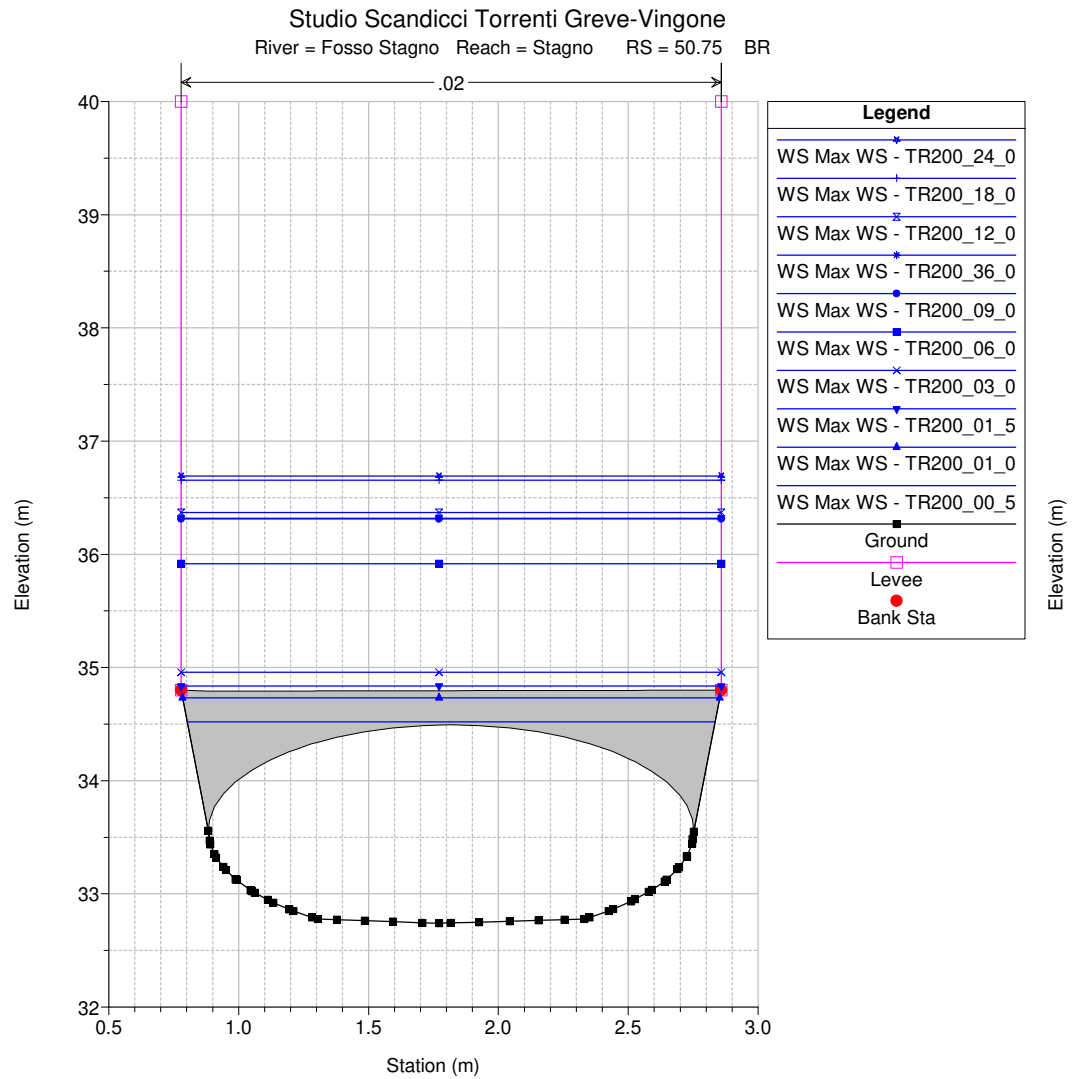

Studio Scandicci Torrenti Greve-Vingone
River = Fosso Stagno Reach = Stagno RS = 49.4

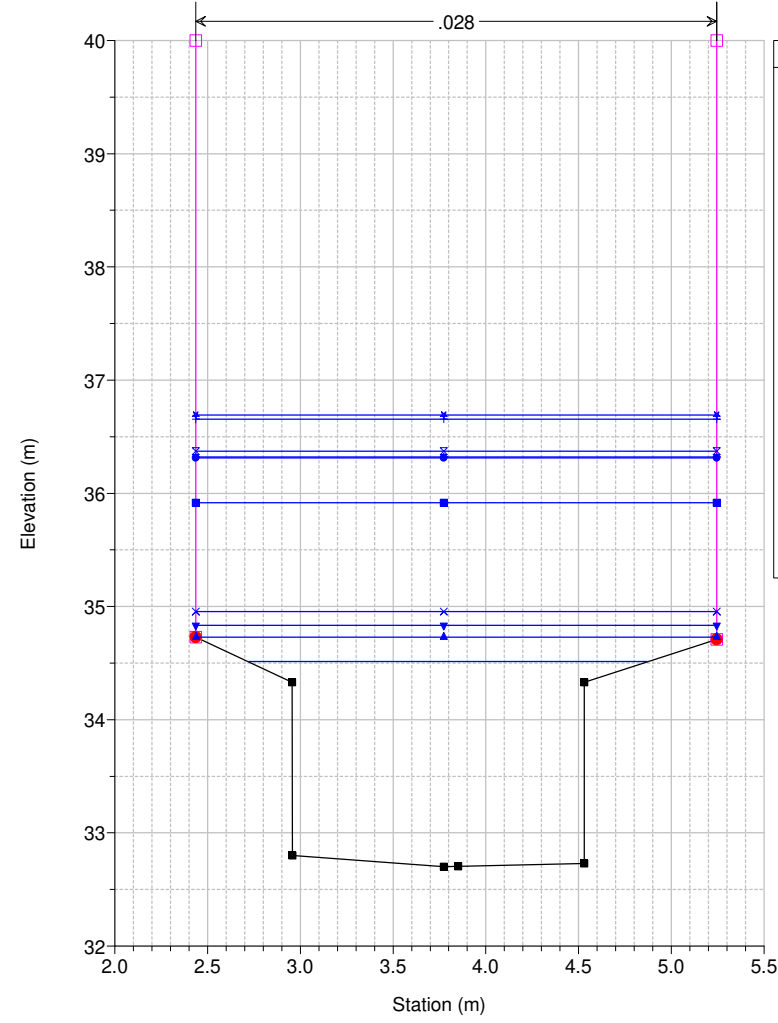

Legend

- WS Max WS - TR200_24_0
- WS Max WS - TR200_18_0
- WS Max WS - TR200_12_0
- WS Max WS - TR200_36_0
- WS Max WS - TR200_09_0
- WS Max WS - TR200_06_0
- WS Max WS - TR200_03_0
- WS Max WS - TR200_01_5
- WS Max WS - TR200_01_0
- WS Max WS - TR200_00_5
- Ground
- Levee
- Bank Sta

Studio Scandicci Torrenti Greve-Vingone
River = Fosso Stagno Reach = Stagno RS = 49 SG0024_P

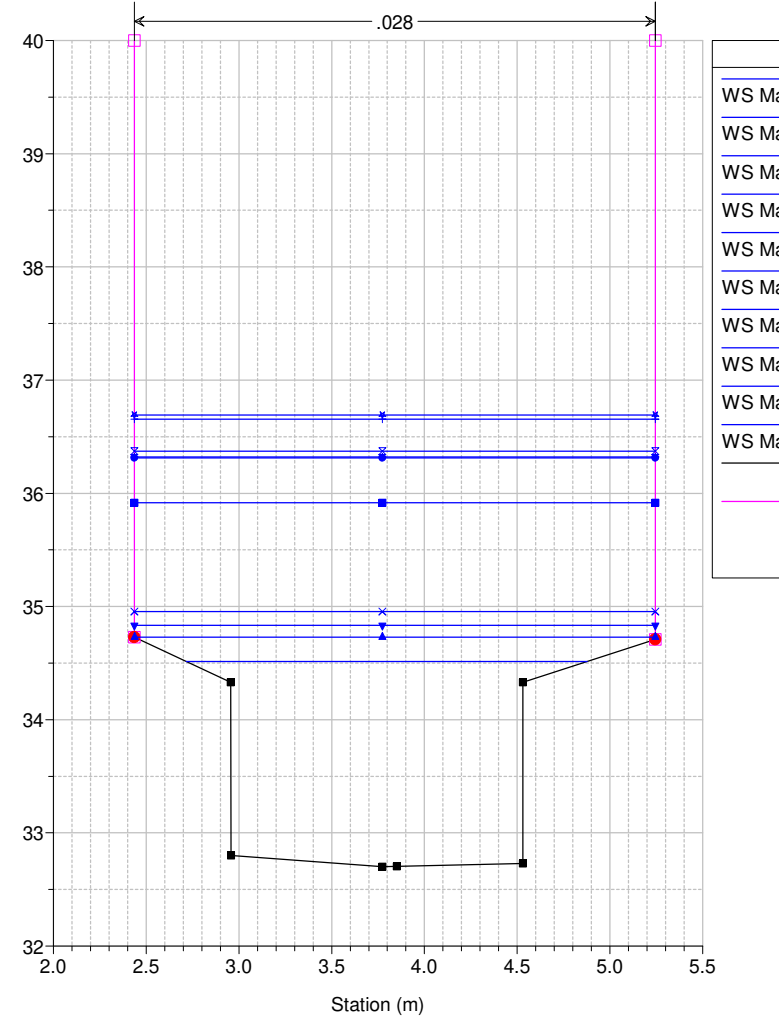

Legend

- WS Max WS - TR200_24_0
- WS Max WS - TR200_18_0
- WS Max WS - TR200_12_0
- WS Max WS - TR200_36_0
- WS Max WS - TR200_09_0
- WS Max WS - TR200_06_0
- WS Max WS - TR200_03_0
- WS Max WS - TR200_01_5
- WS Max WS - TR200_01_0
- WS Max WS - TR200_00_5
- Ground
- Levee
- Bank Sta

Studio Scandicci Torrenti Greve-Vingone
River = Fosso Stagno Reach = Stagno RS = 48.75 BR

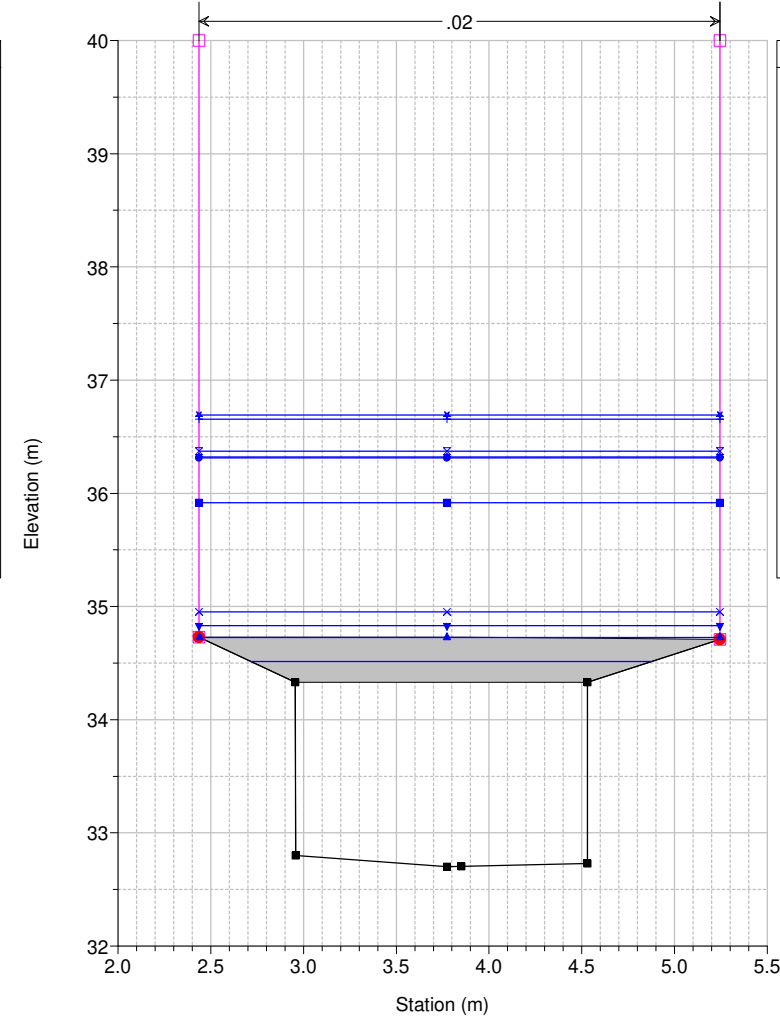

Legend

- WS Max WS - TR200_24_0
- WS Max WS - TR200_18_0
- WS Max WS - TR200_12_0
- WS Max WS - TR200_36_0
- WS Max WS - TR200_09_0
- WS Max WS - TR200_06_0
- WS Max WS - TR200_03_0
- WS Max WS - TR200_01_5
- WS Max WS - TR200_01_0
- WS Max WS - TR200_00_5
- Ground
- Levee
- Bank Sta

Studio Scandicci Torrenti Greve-Vingone
River = Fosso Stagno Reach = Stagno RS = 48.75 BR

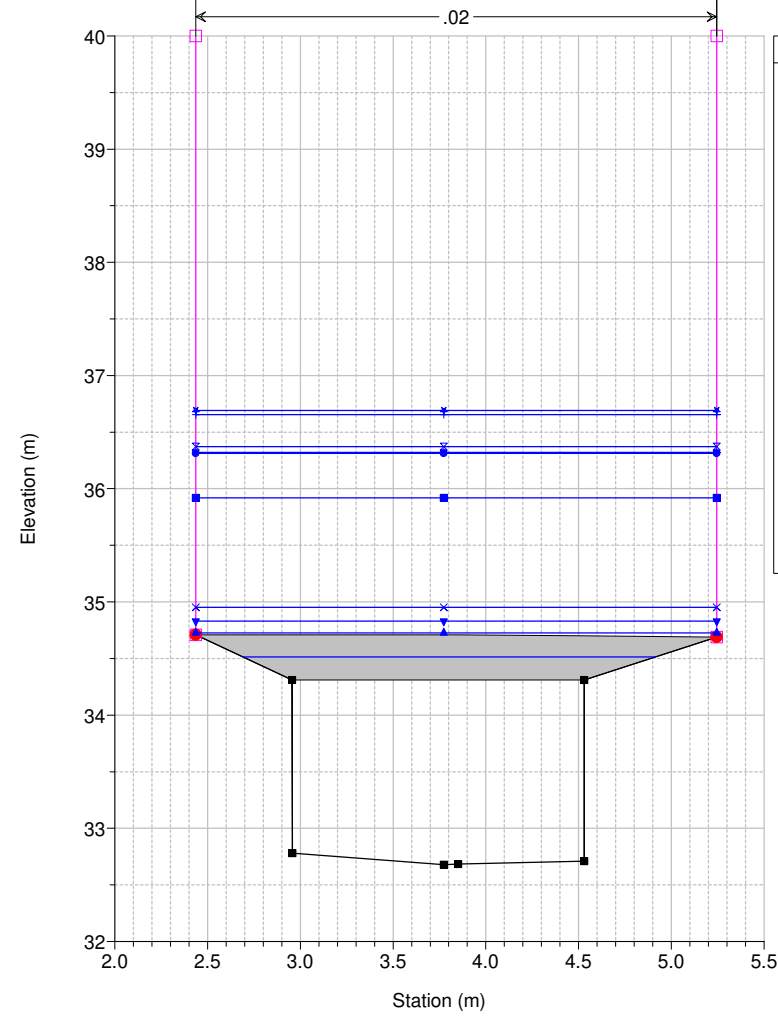

Legend

- WS Max WS - TR200_24_0
- WS Max WS - TR200_18_0
- WS Max WS - TR200_12_0
- WS Max WS - TR200_36_0
- WS Max WS - TR200_09_0
- WS Max WS - TR200_06_0
- WS Max WS - TR200_03_0
- WS Max WS - TR200_01_5
- WS Max WS - TR200_01_0
- WS Max WS - TR200_00_5
- Ground
- Levee
- Bank Sta

Studio Scandicci Torrenti Greve-Vingone
River = Fosso Stagno Reach = Stagno RS = 48.7

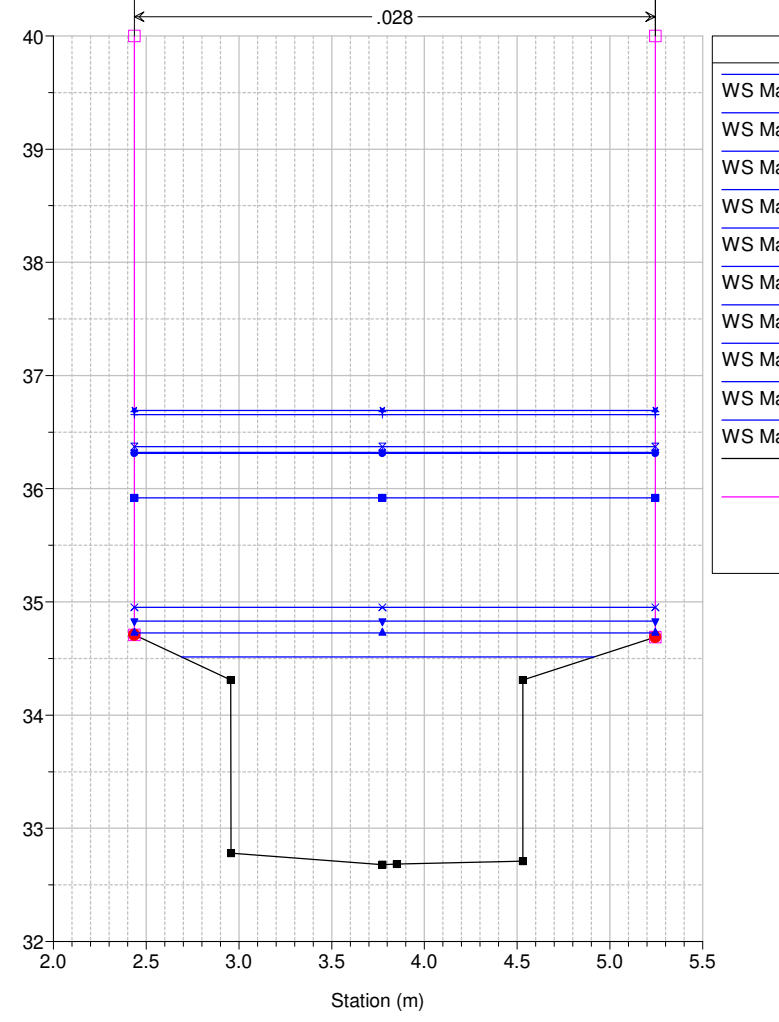

Legend

- WS Max WS - TR200_24_0
- WS Max WS - TR200_18_0
- WS Max WS - TR200_12_0
- WS Max WS - TR200_36_0
- WS Max WS - TR200_09_0
- WS Max WS - TR200_06_0
- WS Max WS - TR200_03_0
- WS Max WS - TR200_01_5
- WS Max WS - TR200_01_0
- WS Max WS - TR200_00_5
- Ground
- Levee
- Bank Sta

Studio Scandicci Torrenti Greve-Vingone
River = Fosso Stagno Reach = Stagno RS = 48 SG0024_Q

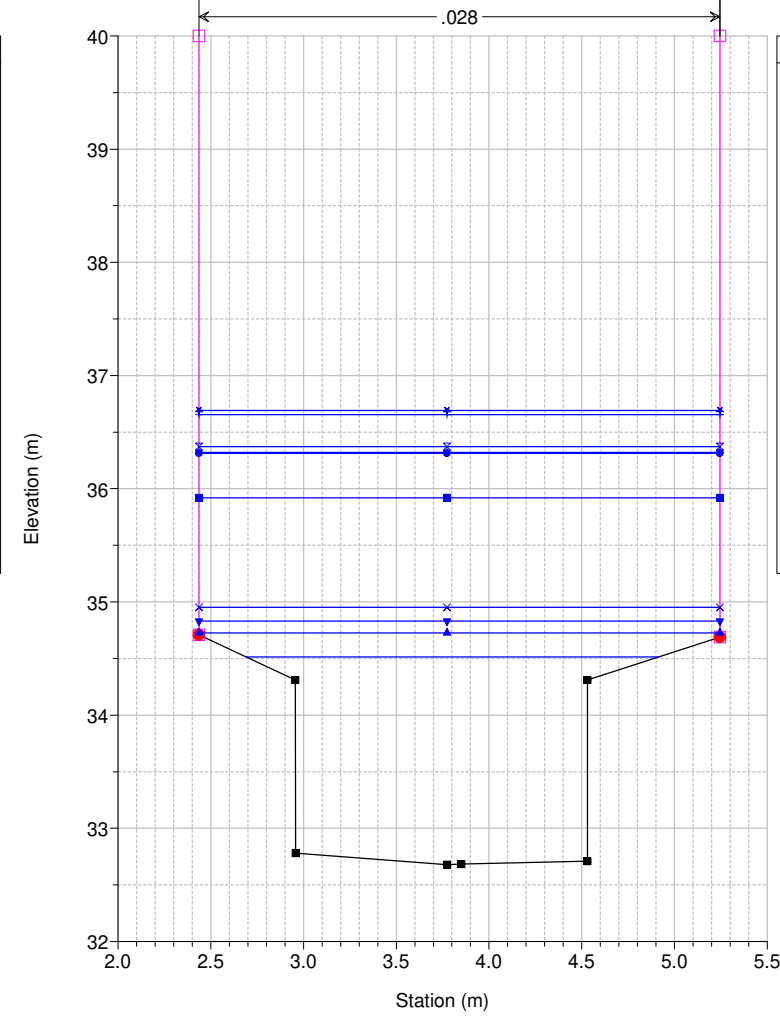

Legend

- WS Max WS - TR200_24_0
- WS Max WS - TR200_18_0
- WS Max WS - TR200_12_0
- WS Max WS - TR200_36_0
- WS Max WS - TR200_09_0
- WS Max WS - TR200_06_0
- WS Max WS - TR200_03_0
- WS Max WS - TR200_01_5
- WS Max WS - TR200_01_0
- WS Max WS - TR200_00_5
- Ground
- Levee
- Bank Sta

Studio Scandicci Torrenti Greve-Vingone
River = Fosso Stagno Reach = Stagno RS = 47.75 BR

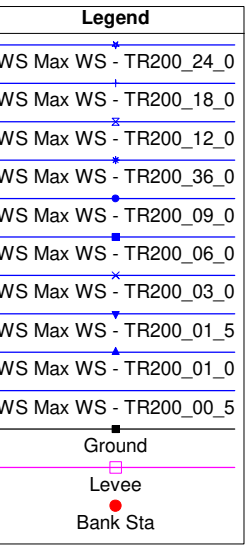
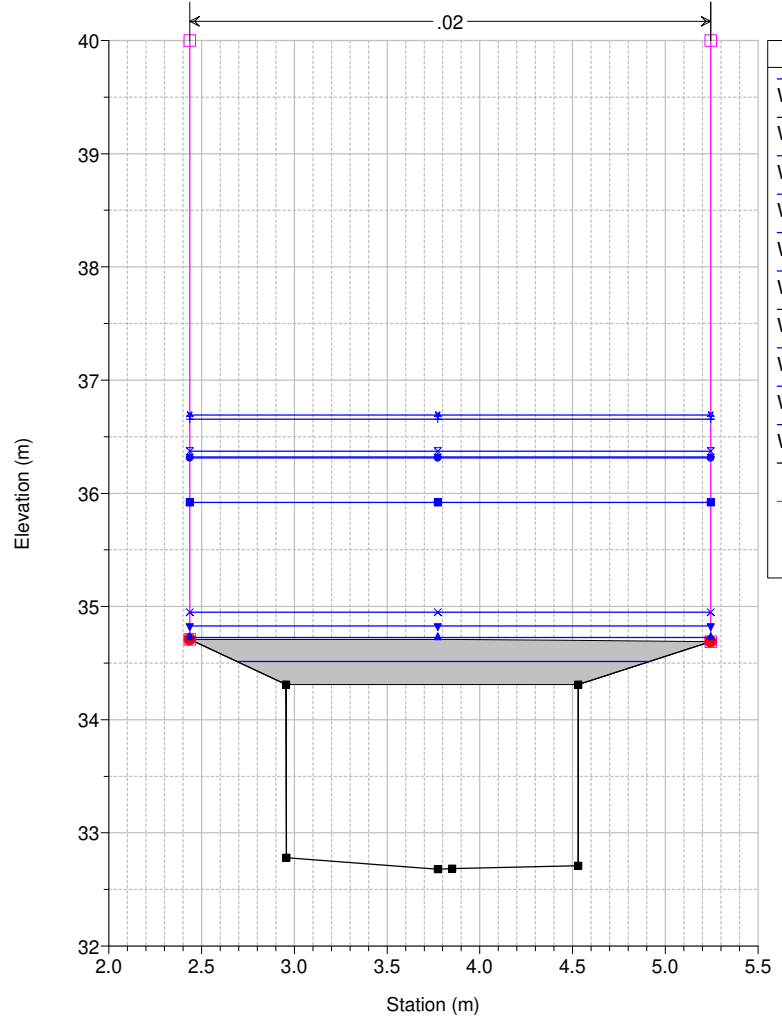

Studio Scandicci Torrenti Greve-Vingone
River = Fosso Stagno Reach = Stagno RS = 47.75 BR

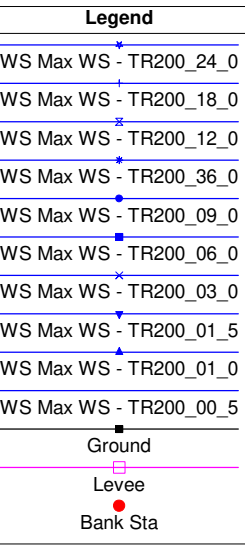
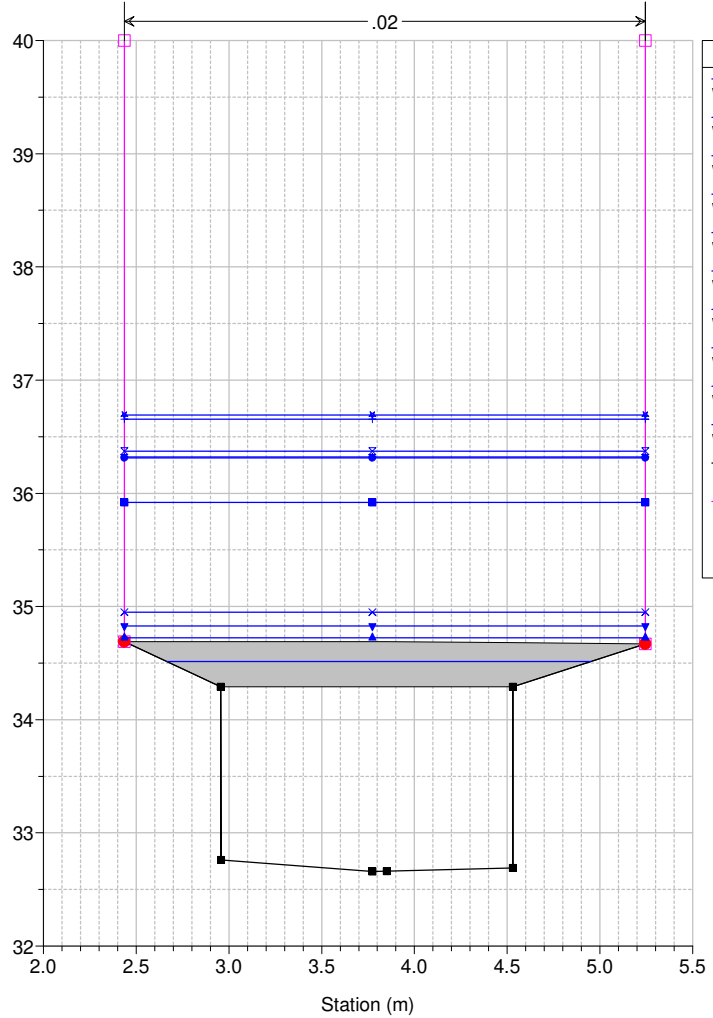

Studio Scandicci Torrenti Greve-Vingone
River = Fosso Stagno Reach = Stagno RS = 47.4

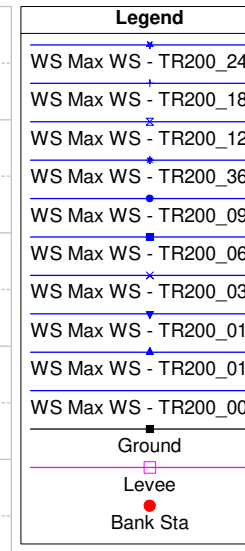
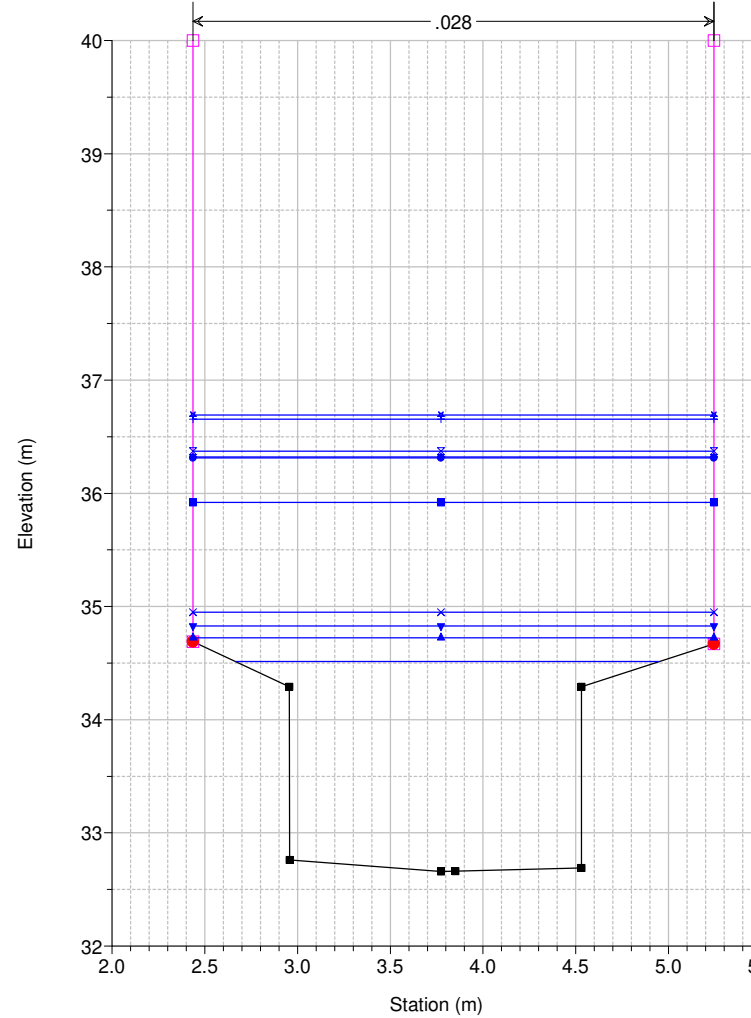

Studio Scandicci Torrenti Greve-Vingone
River = Fosso Stagno Reach = Stagno RS = 47 SG0024_R

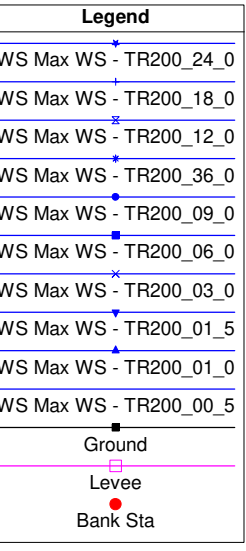
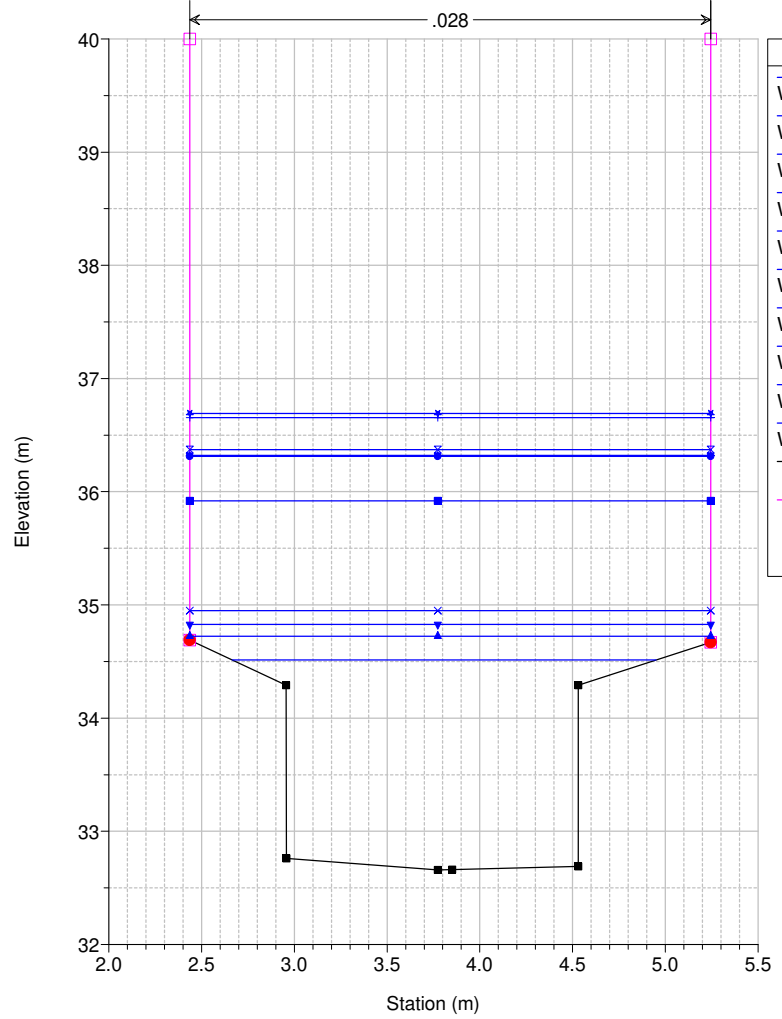

Studio Scandicci Torrenti Greve-Vingone
River = Fosso Stagno Reach = Stagno RS = 46.75 BR

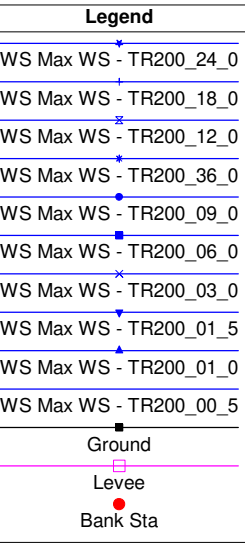
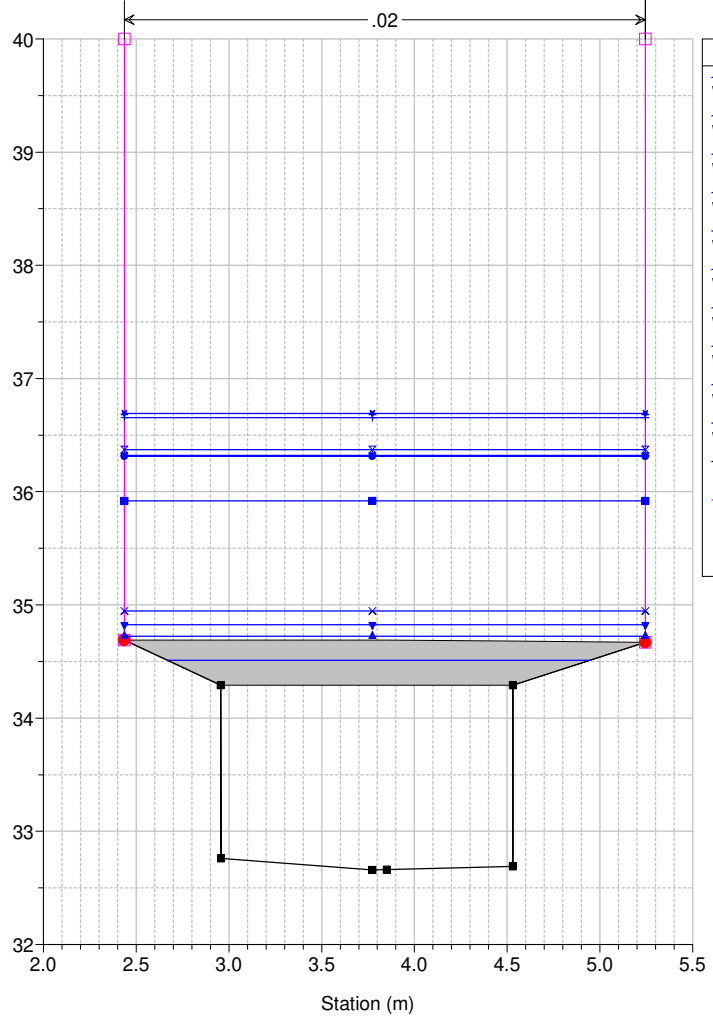

Studio Scandicci Torrenti Greve-Vingone
River = Fosso Stagno Reach = Stagno RS = 46.75 BR

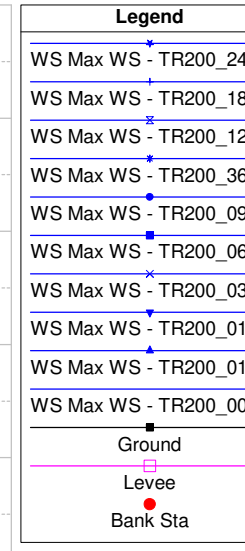
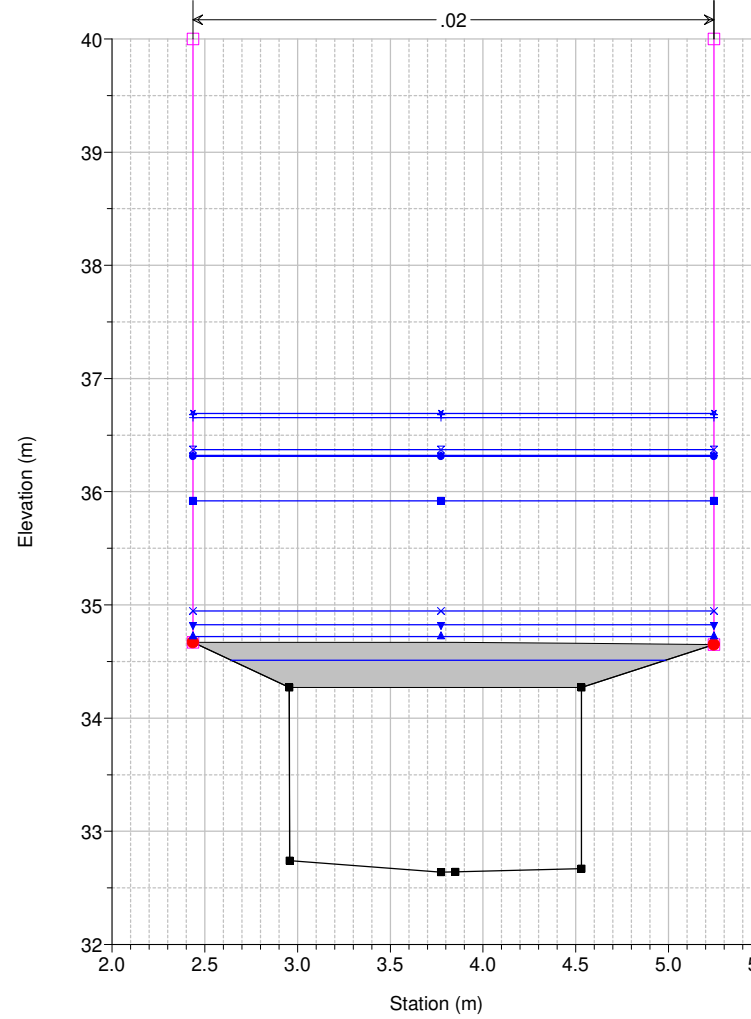

Studio Scandicci Torrenti Greve-Vingone
River = Fosso Stagno Reach = Stagno RS = 46.4

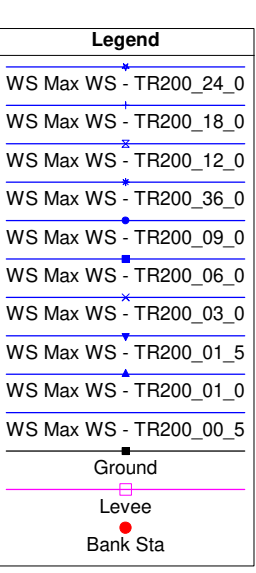
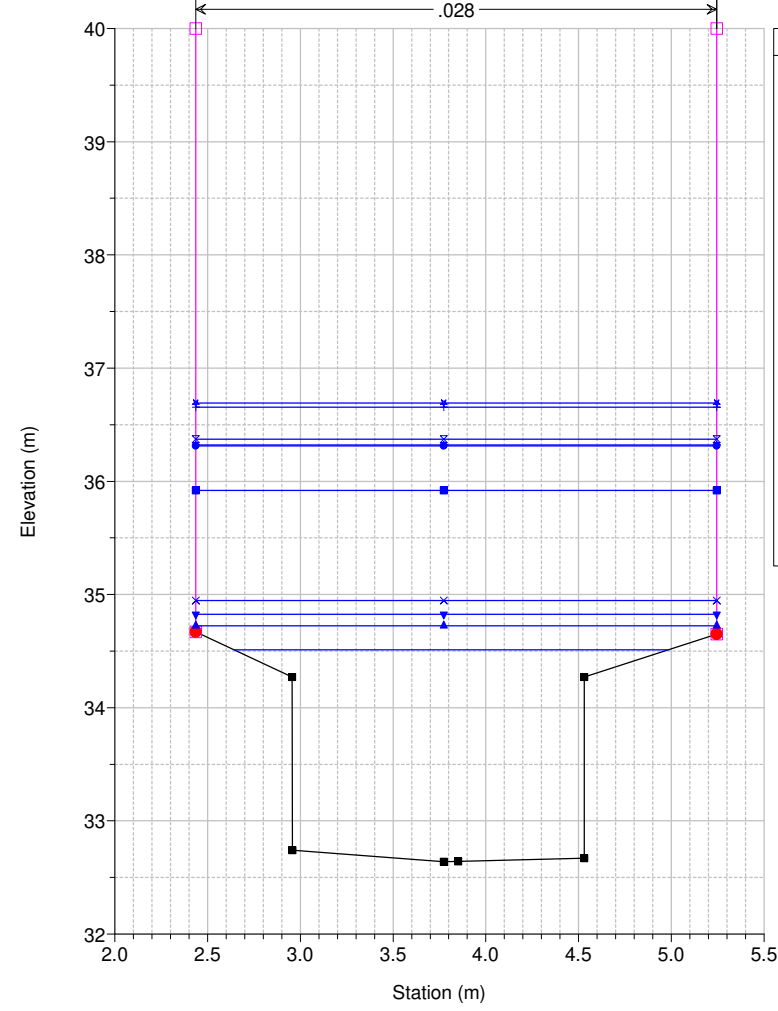

Studio Scandicci Torrenti Greve-Vingone
River = Fosso Stagno Reach = Stagno RS = 46 SG0024_S

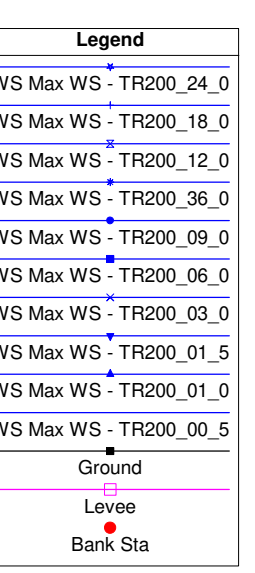
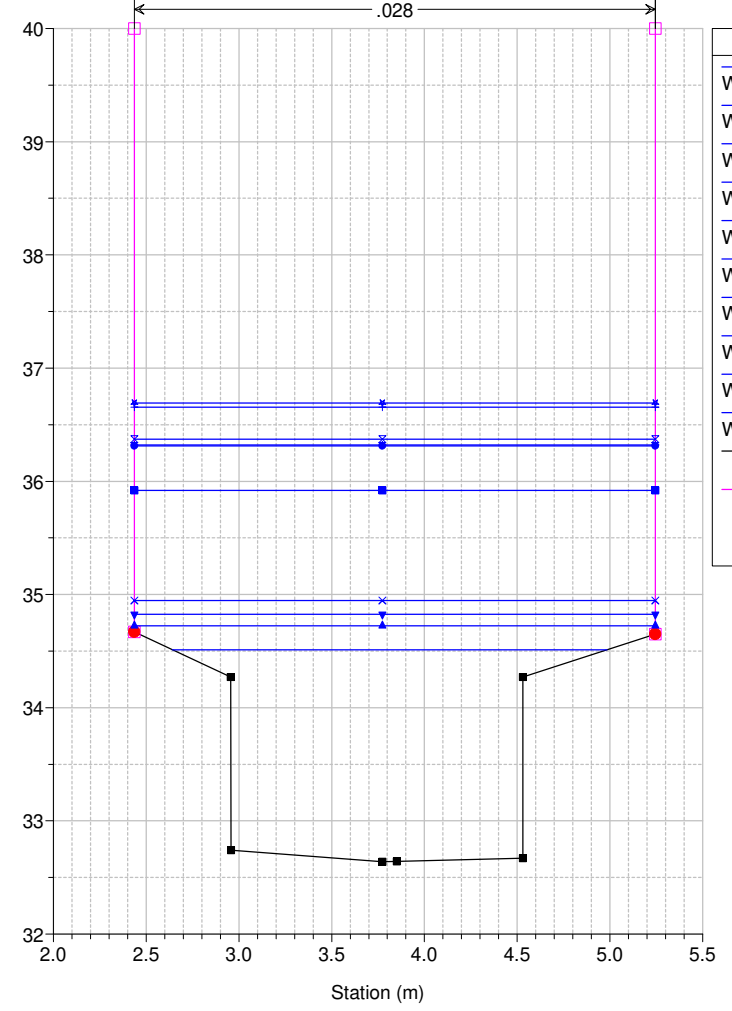

Studio Scandicci Torrenti Greve-Vingone
River = Fosso Stagno Reach = Stagno RS = 45.75 BR

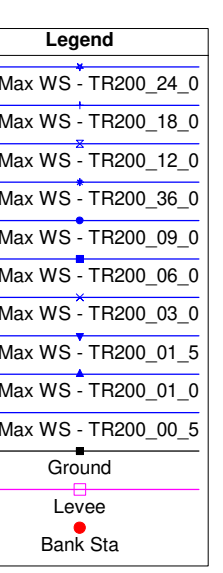
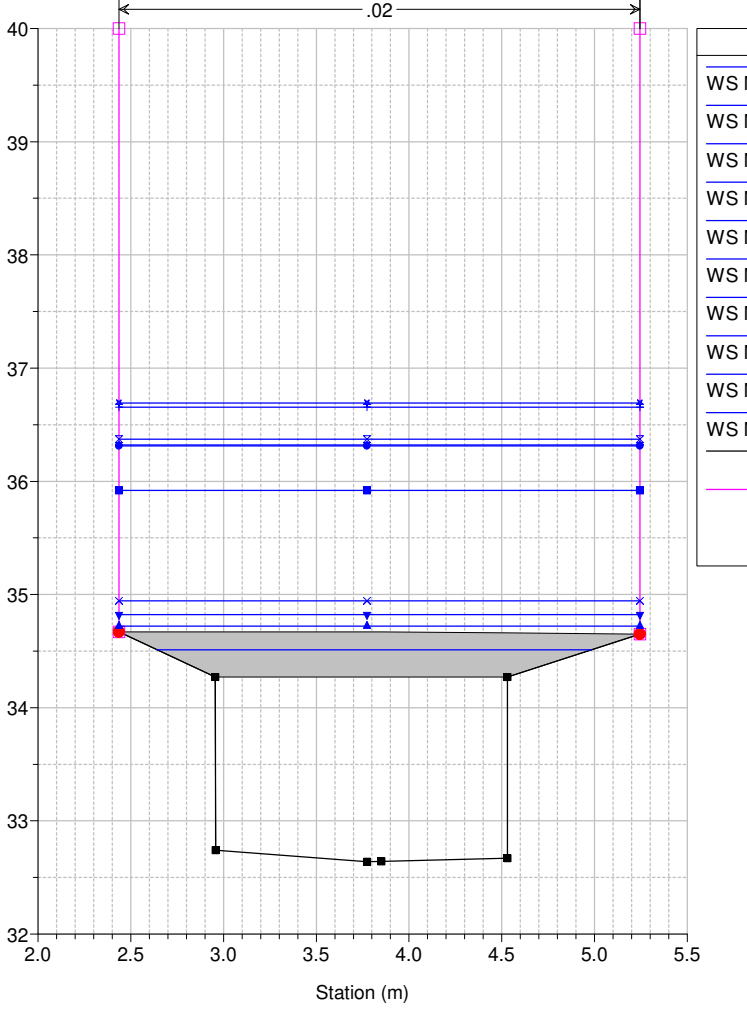

Studio Scandicci Torrenti Greve-Vingone
River = Fosso Stagno Reach = Stagno RS = 45.75 BR

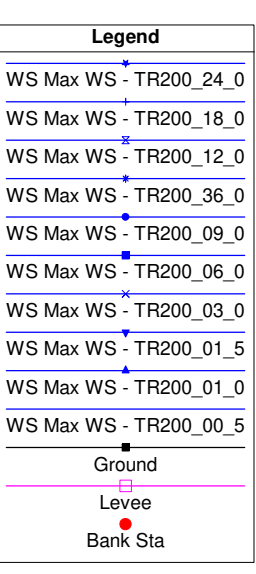
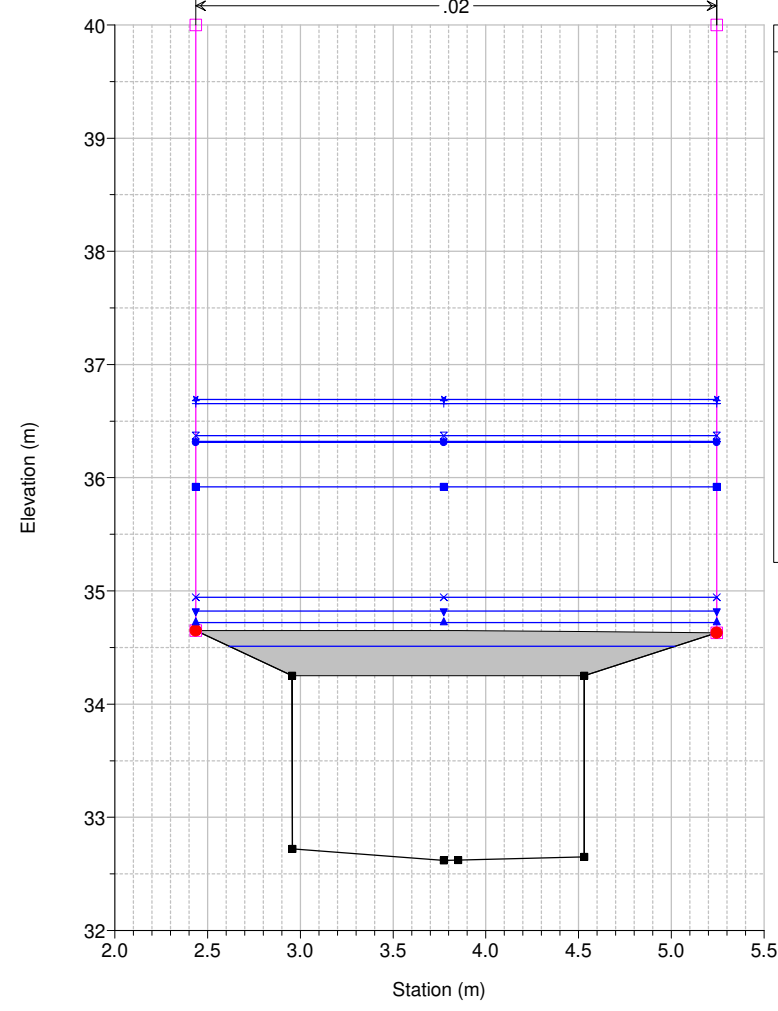

Studio Scandicci Torrenti Greve-Vingone
River = Fosso Stagno Reach = Stagno RS = 45.4

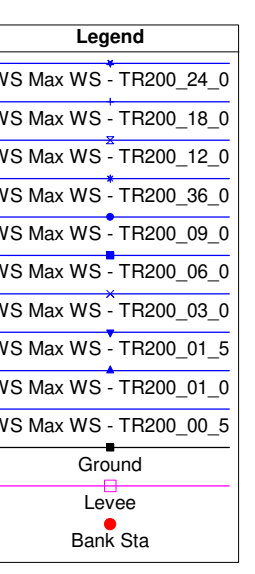
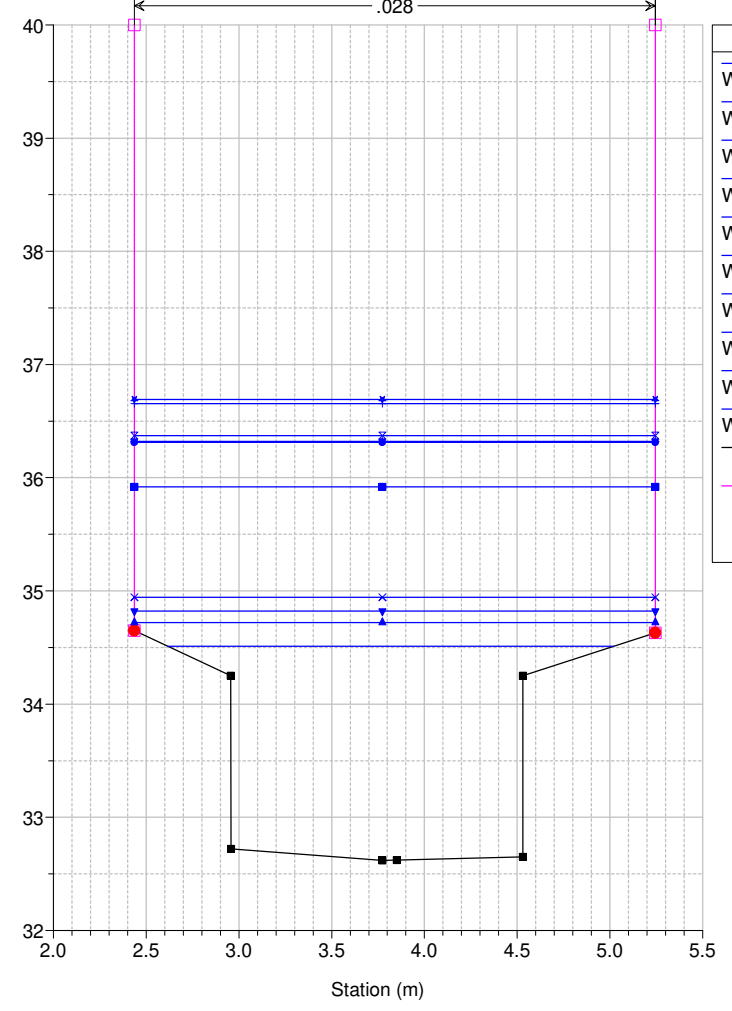

Studio Scandicci Torrenti Greve-Vingone
River = Fosso Stagno Reach = Stagno RS = 45 SG0024_T

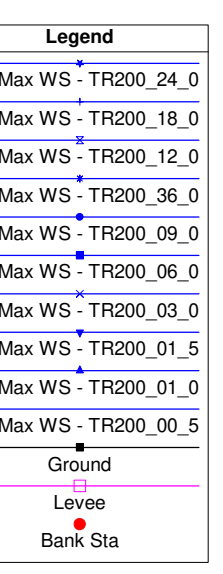
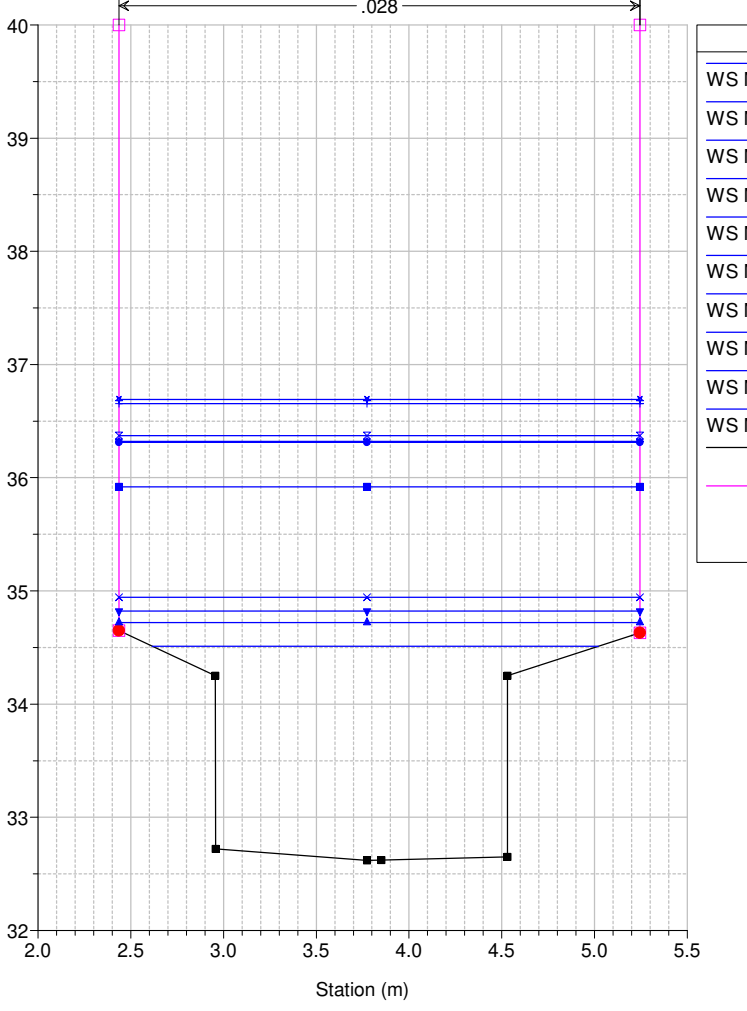

Studio Scandicci Torrenti Greve-Vingone
River = Fosso Stagno Reach = Stagno RS = 44.75 BR

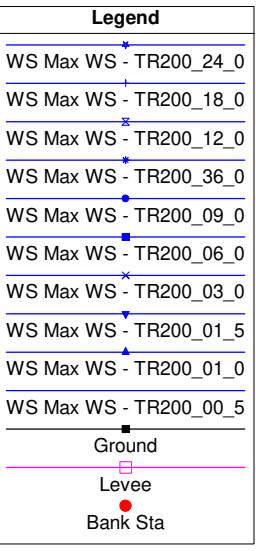
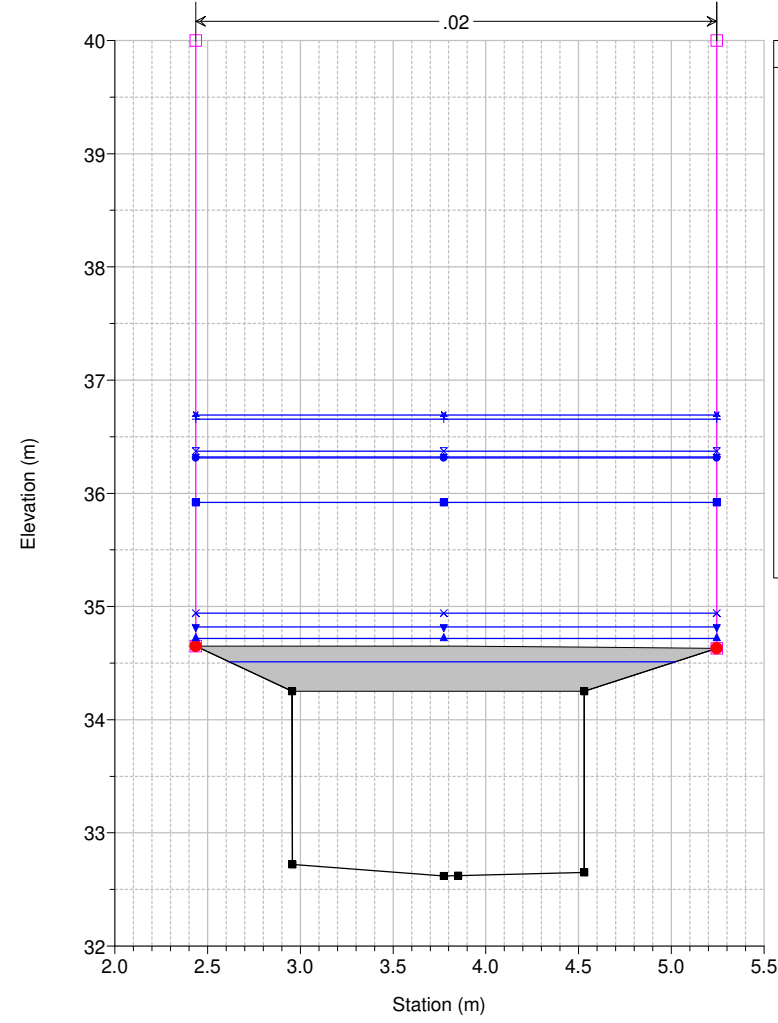

Studio Scandicci Torrenti Greve-Vingone
River = Fosso Stagno Reach = Stagno RS = 44.75 BR

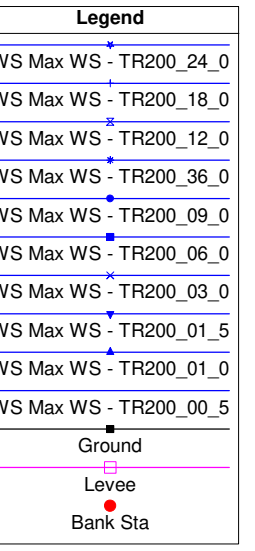
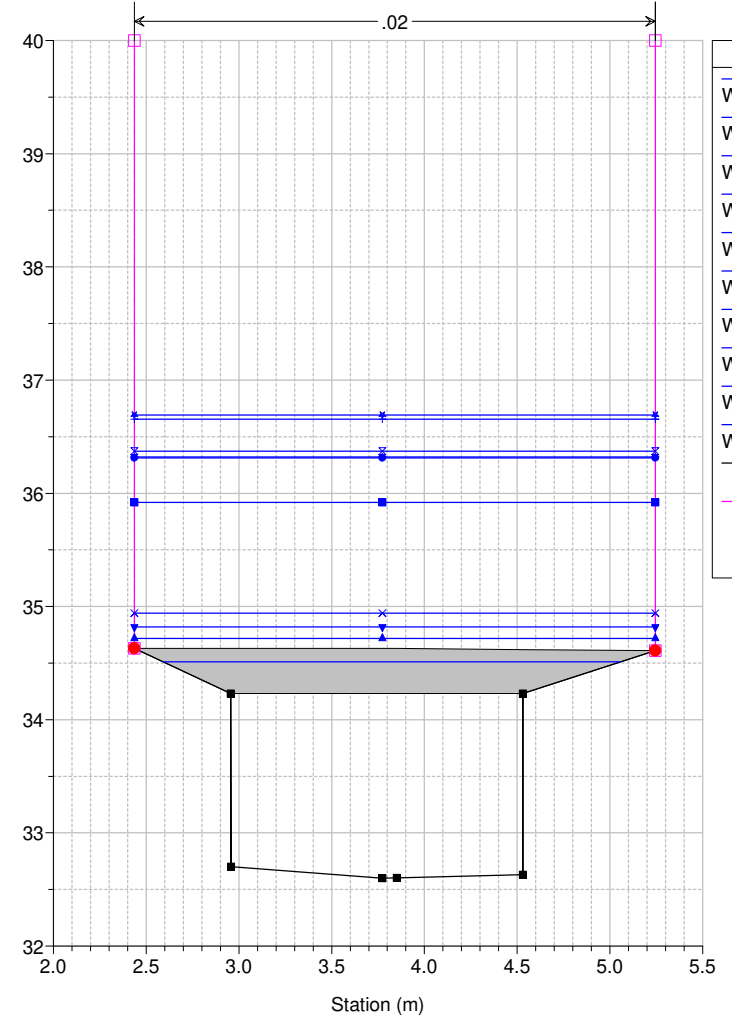

Studio Scandicci Torrenti Greve-Vingone
River = Fosso Stagno Reach = Stagno RS = 44 SG0024_C

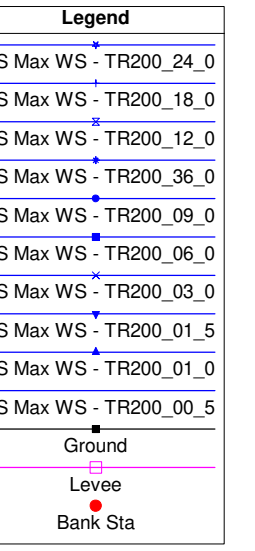
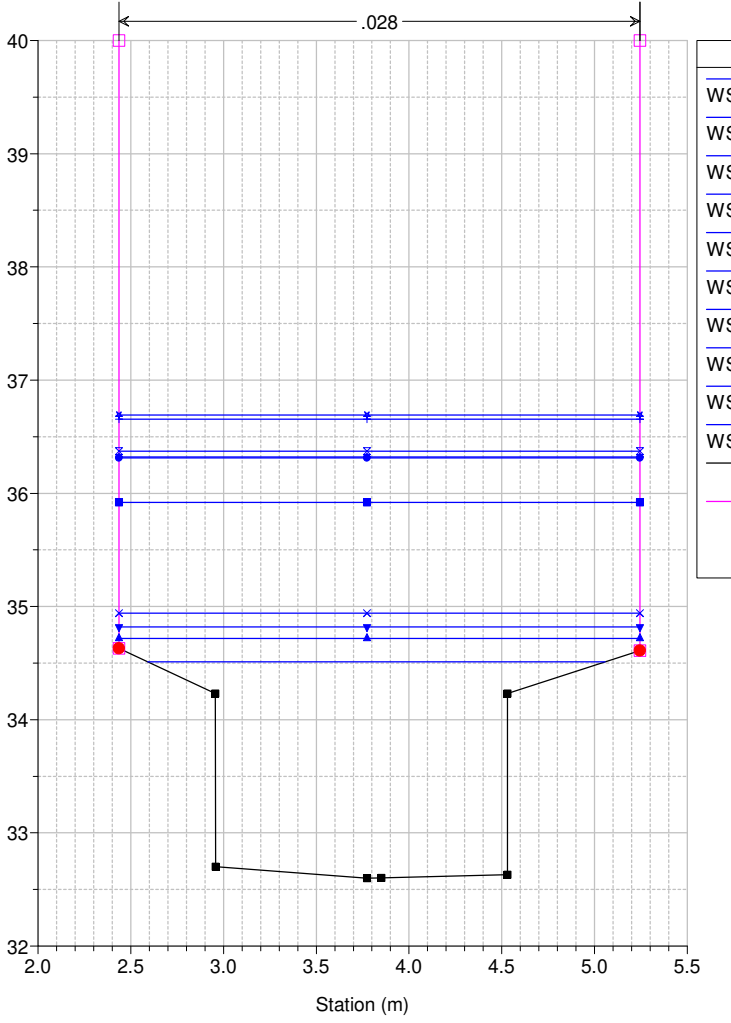

Studio Scandicci Torrenti Greve-Vingone
River = Fosso Stagno Reach = Stagno RS = 43 SG0024_D

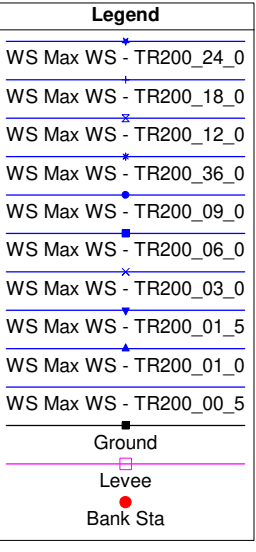
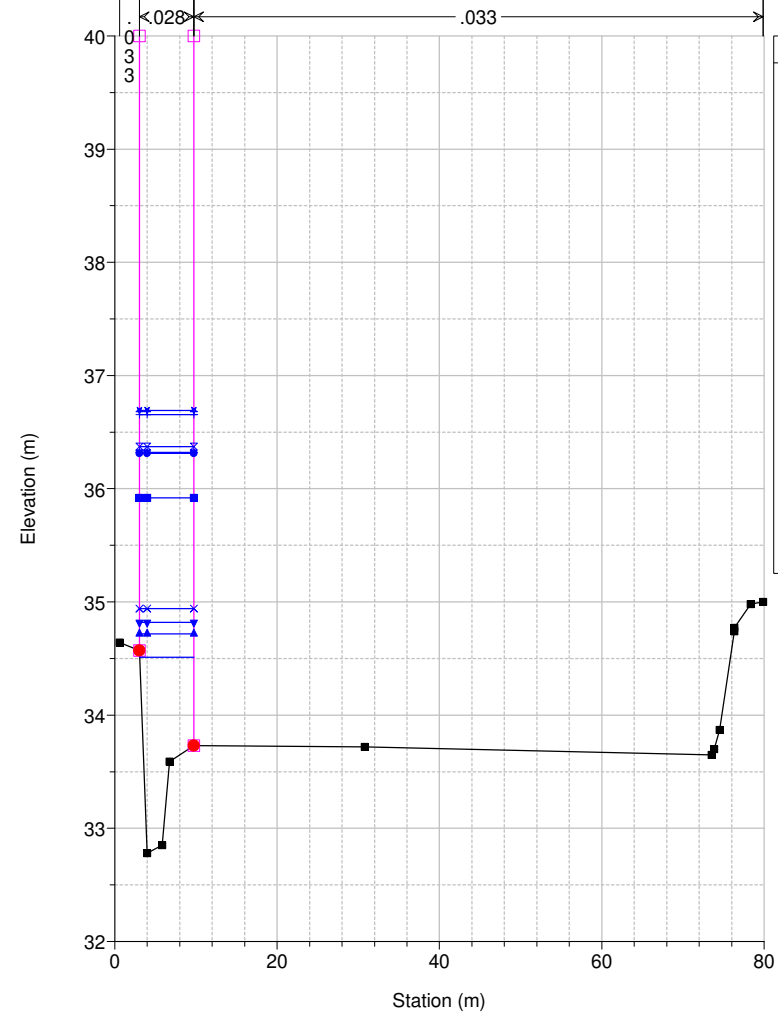

Studio Scandicci Torrenti Greve-Vingone
River = Fosso Stagno Reach = Stagno RS = 42 SG0025_

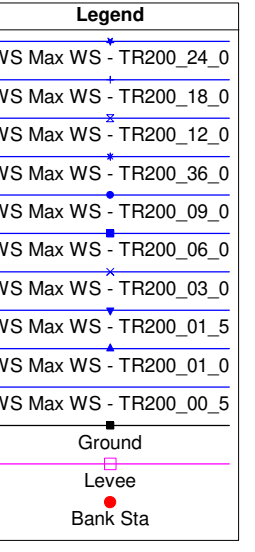
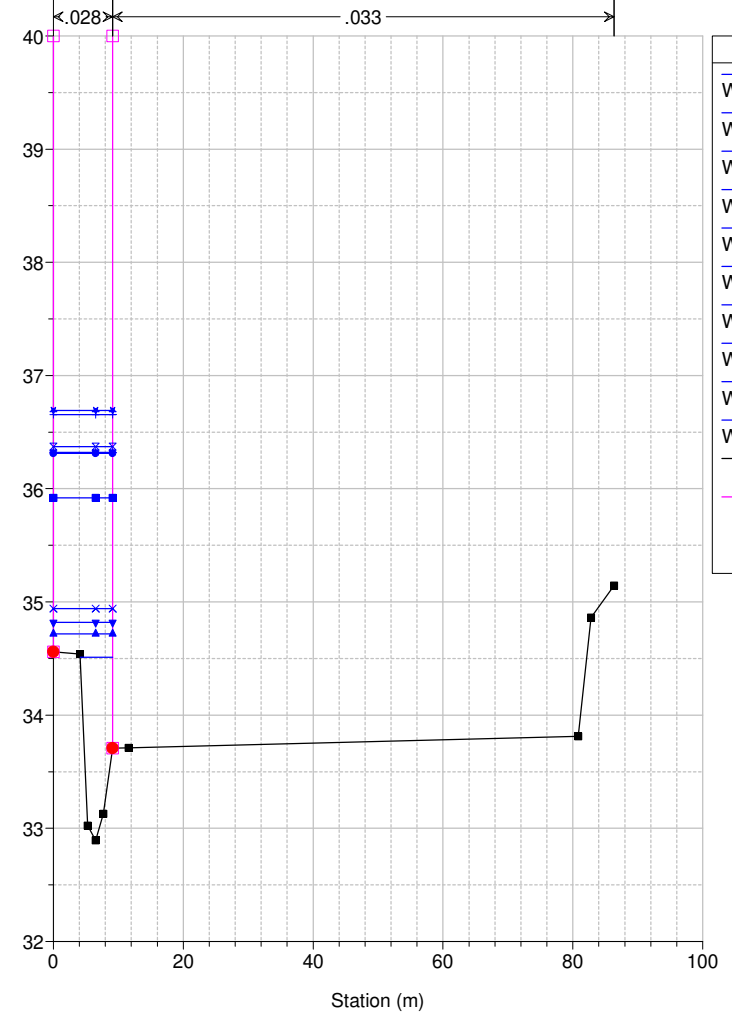

Studio Scandicci Torrenti Greve-Vingone
River = Fosso Stagno Reach = Stagno RS = 41 SG0026_

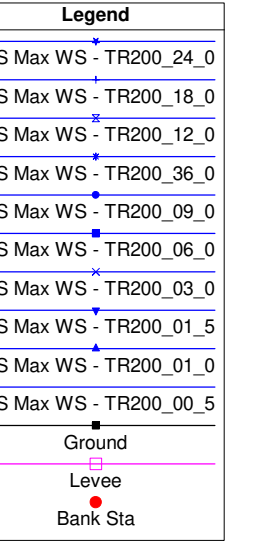
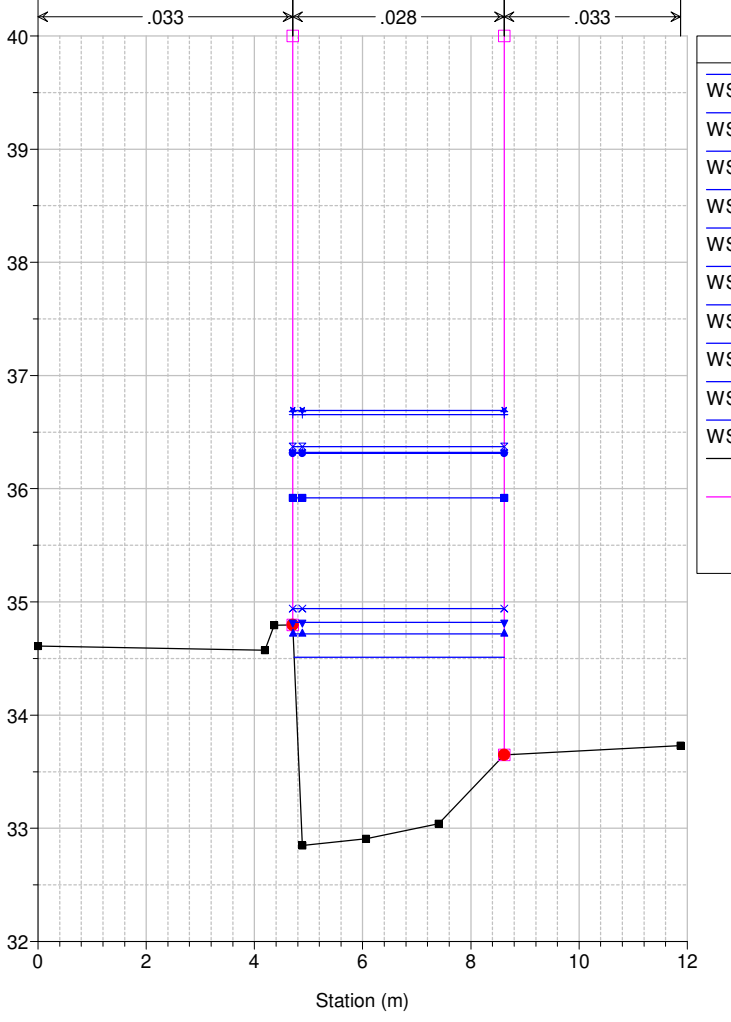

Studio Scandicci Torrenti Greve-Vingone
River = Fosso Stagno Reach = Stagno RS = 40 SG0027__

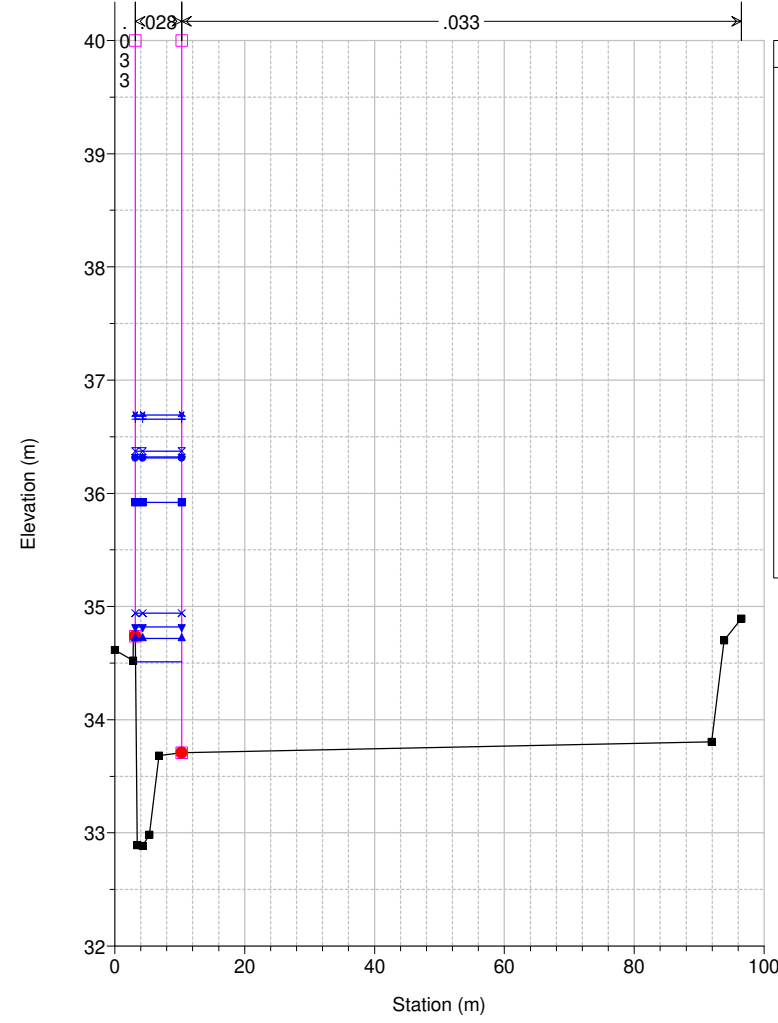

Legend

- WS Max WS - TR200_24_0
- WS Max WS - TR200_18_0
- WS Max WS - TR200_12_0
- WS Max WS - TR200_36_0
- WS Max WS - TR200_09_0
- WS Max WS - TR200_06_0
- WS Max WS - TR200_03_0
- WS Max WS - TR200_01_5
- WS Max WS - TR200_01_0
- WS Max WS - TR200_00_5
- Ground
- Levee
- Bank Sta

Studio Scandicci Torrenti Greve-Vingone
River = Fosso Stagno Reach = Stagno RS = 39 SG0028__

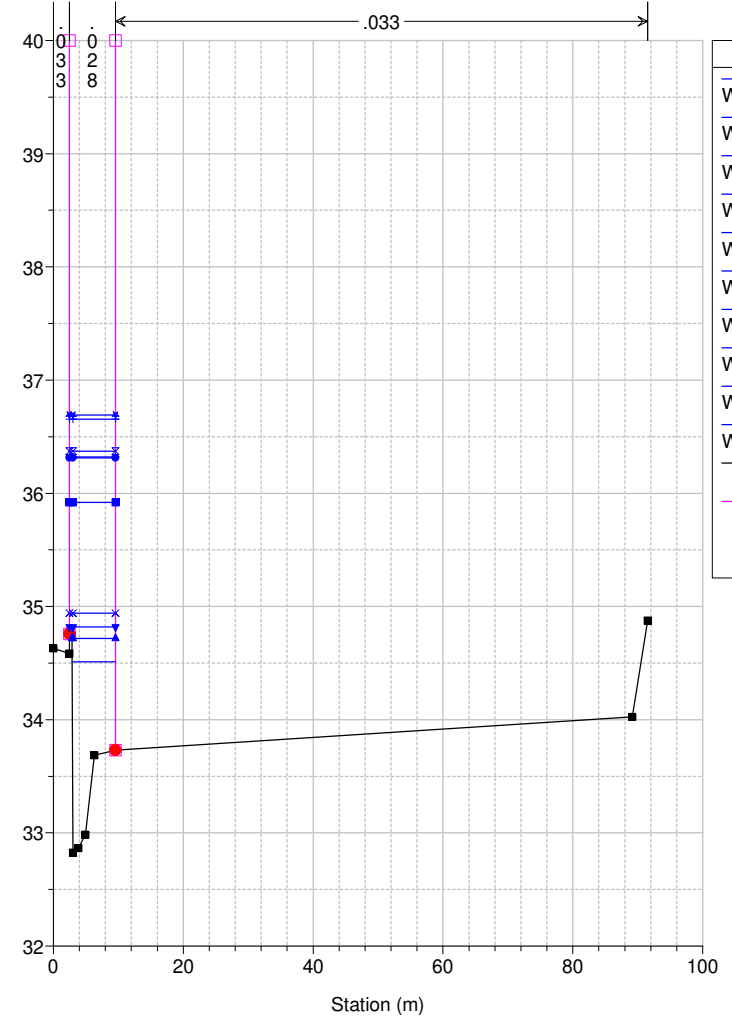

Legend

- WS Max WS - TR200_24_0
- WS Max WS - TR200_18_0
- WS Max WS - TR200_12_0
- WS Max WS - TR200_36_0
- WS Max WS - TR200_09_0
- WS Max WS - TR200_06_0
- WS Max WS - TR200_03_0
- WS Max WS - TR200_01_5
- WS Max WS - TR200_01_0
- WS Max WS - TR200_00_5
- Ground
- Levee
- Bank Sta

Studio Scandicci Torrenti Greve-Vingone
River = Fosso Stagno Reach = Stagno RS = 38 SG0029__

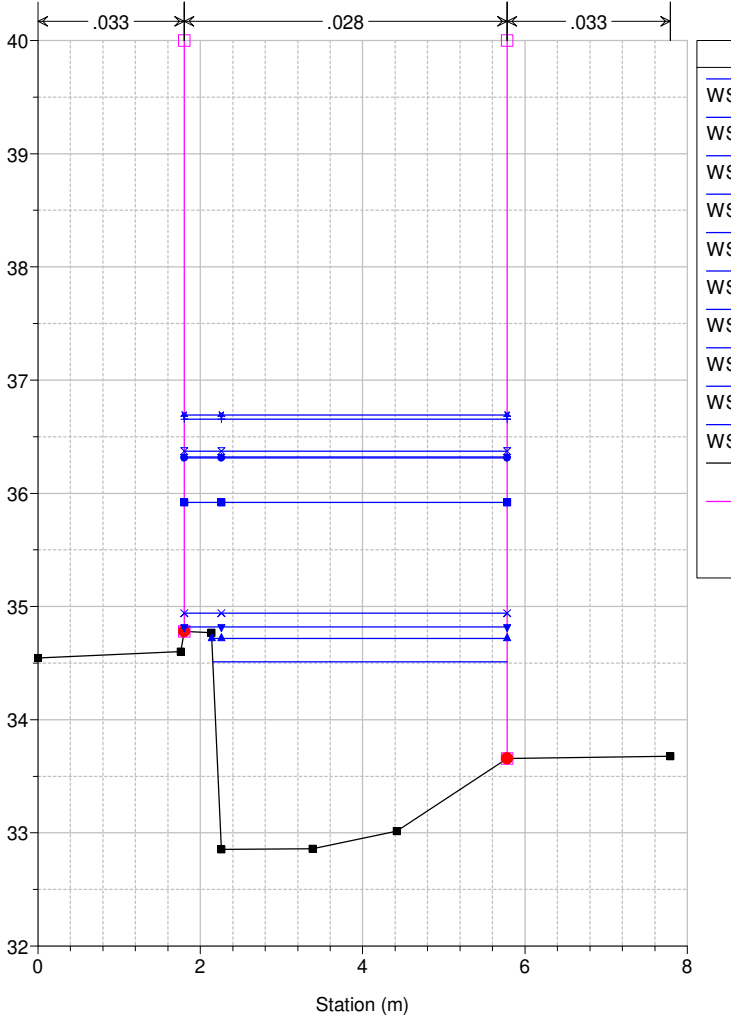

Legend

- WS Max WS - TR200_24_0
- WS Max WS - TR200_18_0
- WS Max WS - TR200_12_0
- WS Max WS - TR200_36_0
- WS Max WS - TR200_09_0
- WS Max WS - TR200_06_0
- WS Max WS - TR200_03_0
- WS Max WS - TR200_01_5
- WS Max WS - TR200_01_0
- WS Max WS - TR200_00_5
- Ground
- Levee
- Bank Sta

Studio Scandicci Torrenti Greve-Vingone
River = Fosso Stagno Reach = Stagno RS = 37 SG0030__

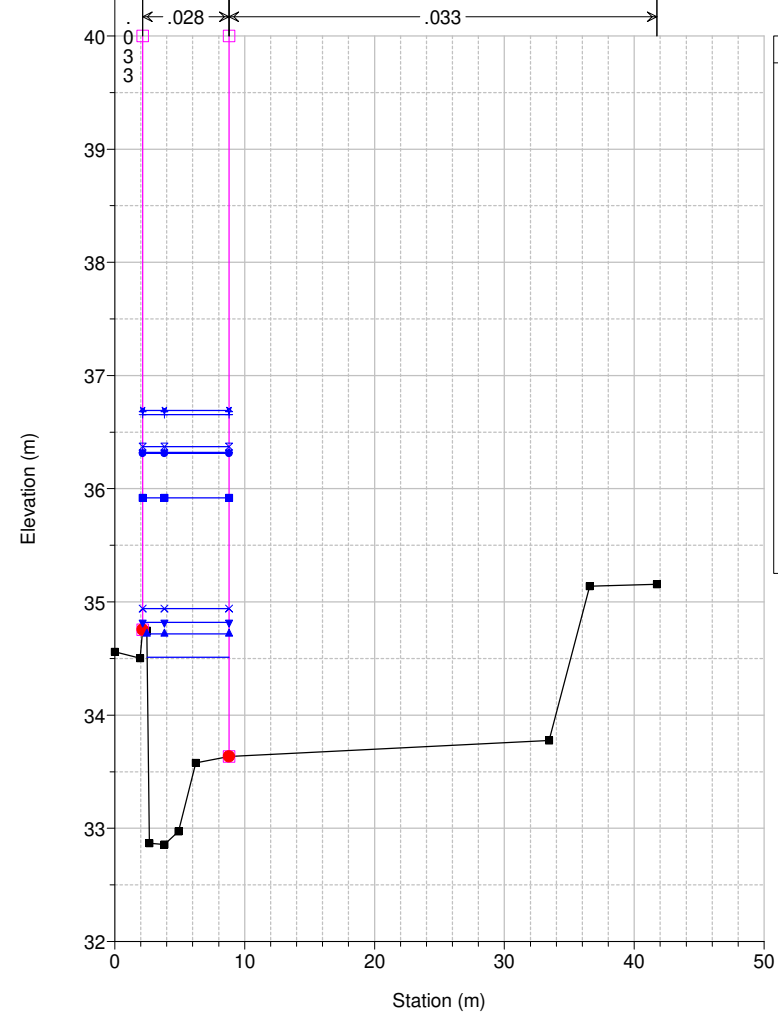

Legend

- WS Max WS - TR200_24_0
- WS Max WS - TR200_18_0
- WS Max WS - TR200_12_0
- WS Max WS - TR200_36_0
- WS Max WS - TR200_09_0
- WS Max WS - TR200_06_0
- WS Max WS - TR200_03_0
- WS Max WS - TR200_01_5
- WS Max WS - TR200_01_0
- WS Max WS - TR200_00_5
- Ground
- Levee
- Bank Sta

Studio Scandicci Torrenti Greve-Vingone
River = Fosso Stagno Reach = Stagno RS = 36 SG0031__

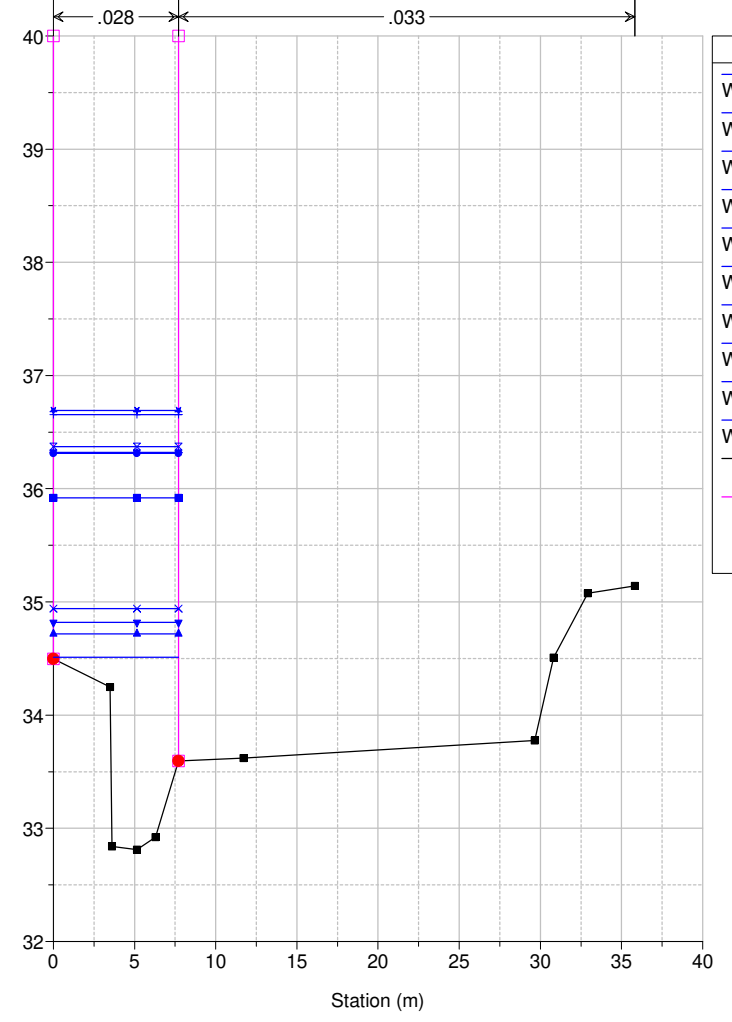

Legend

- WS Max WS - TR200_24_0
- WS Max WS - TR200_18_0
- WS Max WS - TR200_12_0
- WS Max WS - TR200_36_0
- WS Max WS - TR200_09_0
- WS Max WS - TR200_06_0
- WS Max WS - TR200_03_0
- WS Max WS - TR200_01_5
- WS Max WS - TR200_01_0
- WS Max WS - TR200_00_5
- Ground
- Levee
- Bank Sta

Studio Scandicci Torrenti Greve-Vingone
River = Fosso Stagno Reach = Stagno RS = 35 SG0032__

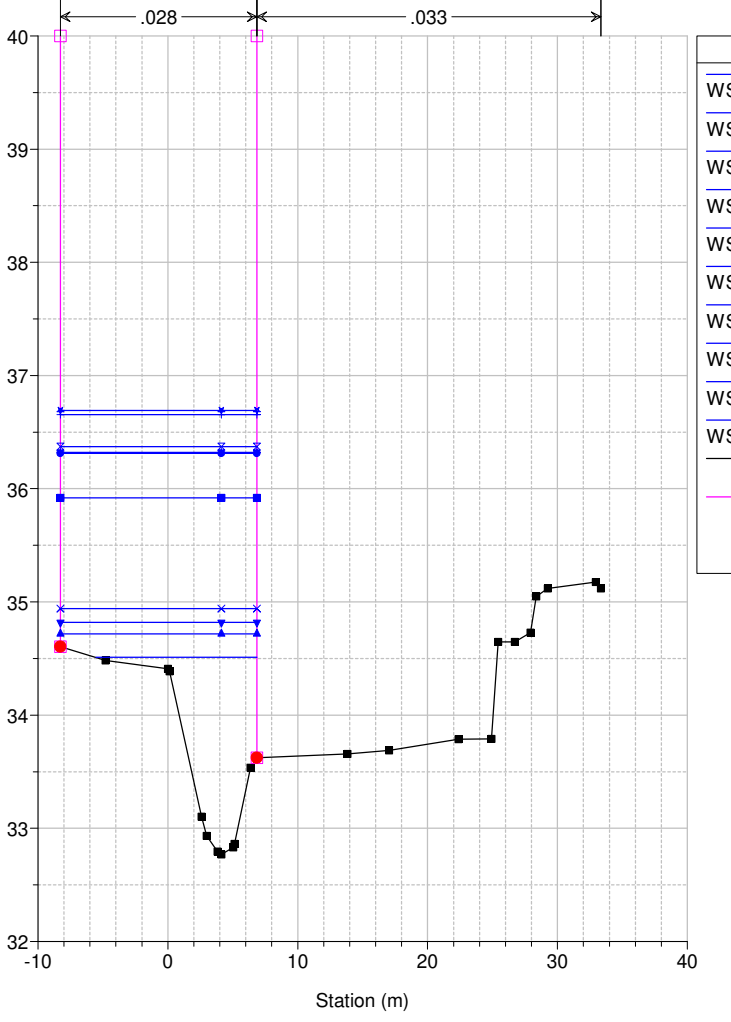

Legend

- WS Max WS - TR200_24_0
- WS Max WS - TR200_18_0
- WS Max WS - TR200_12_0
- WS Max WS - TR200_36_0
- WS Max WS - TR200_09_0
- WS Max WS - TR200_06_0
- WS Max WS - TR200_03_0
- WS Max WS - TR200_01_5
- WS Max WS - TR200_01_0
- WS Max WS - TR200_00_5
- Ground
- Levee
- Bank Sta

Studio Scandicci Torrenti Greve-Vingone
River = Fosso Stagno Reach = Stagno RS = 34 SG0033

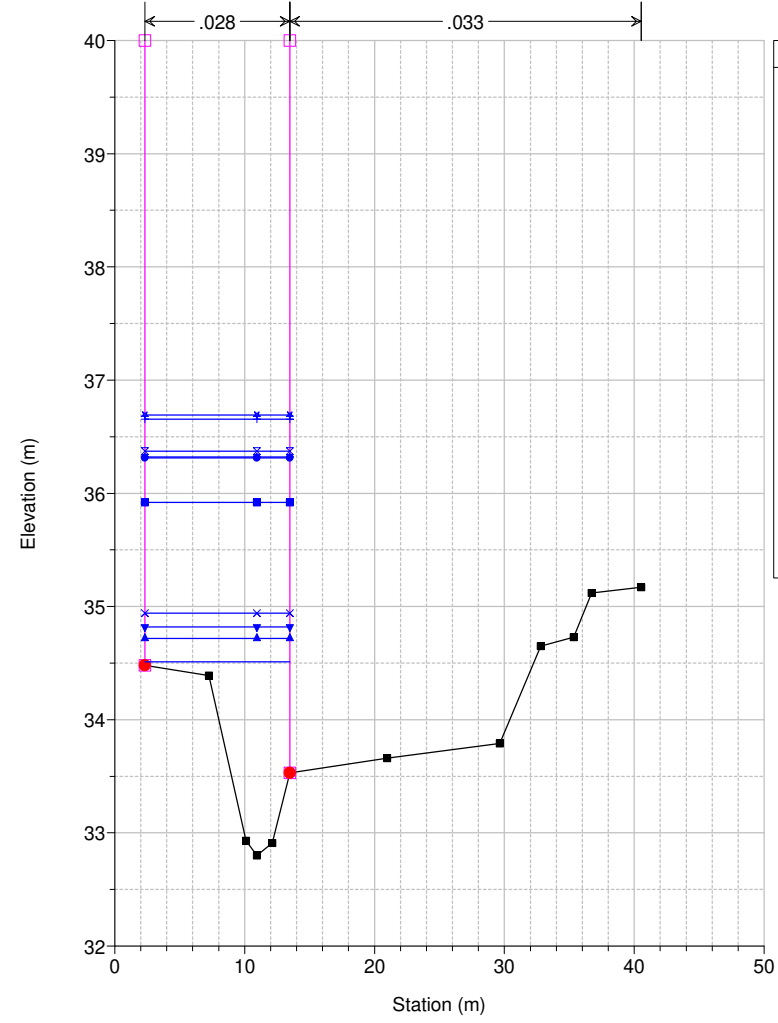

Studio Scandicci Torrenti Greve-Vingone
River = Fosso Stagno Reach = Stagno RS = 33 SG0034

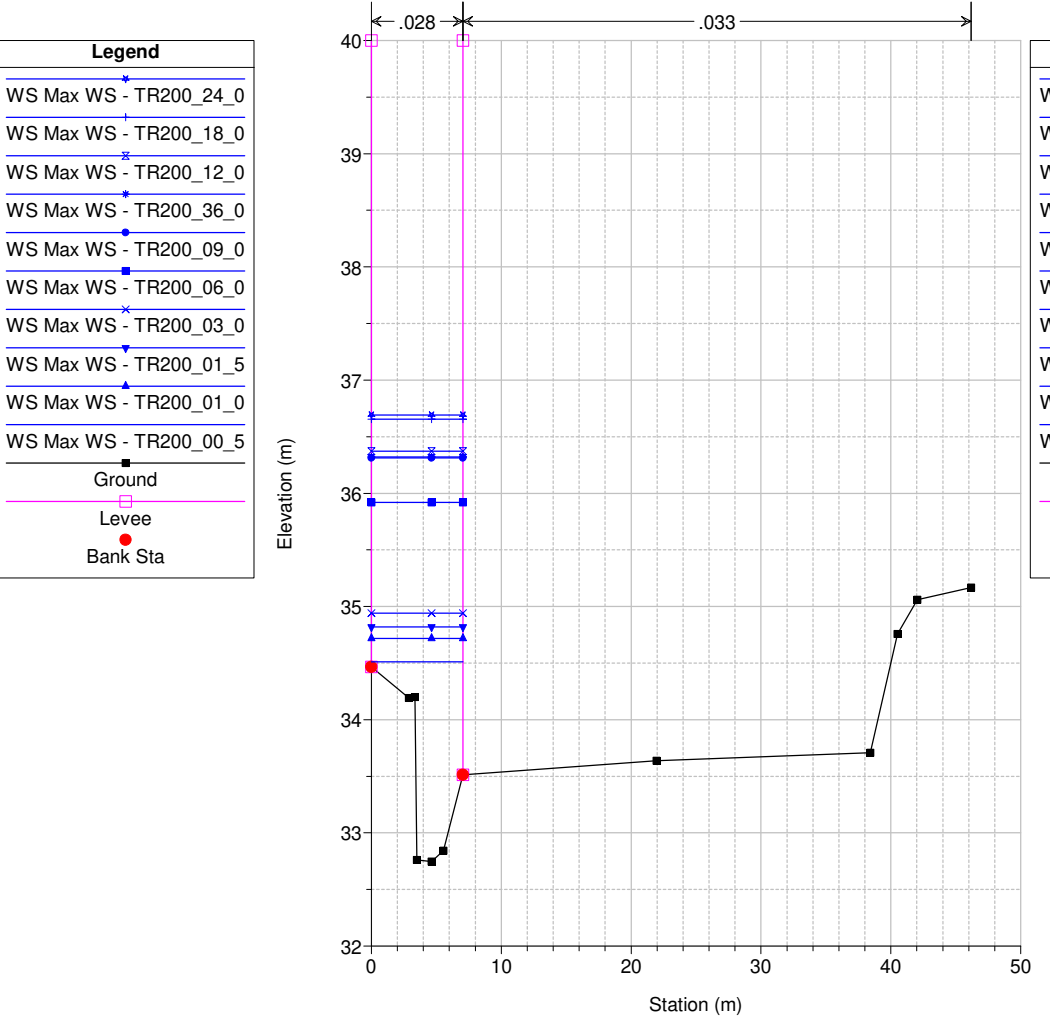

Studio Scandicci Torrenti Greve-Vingone
River = Fosso Stagno Reach = Stagno RS = 32 SG0035

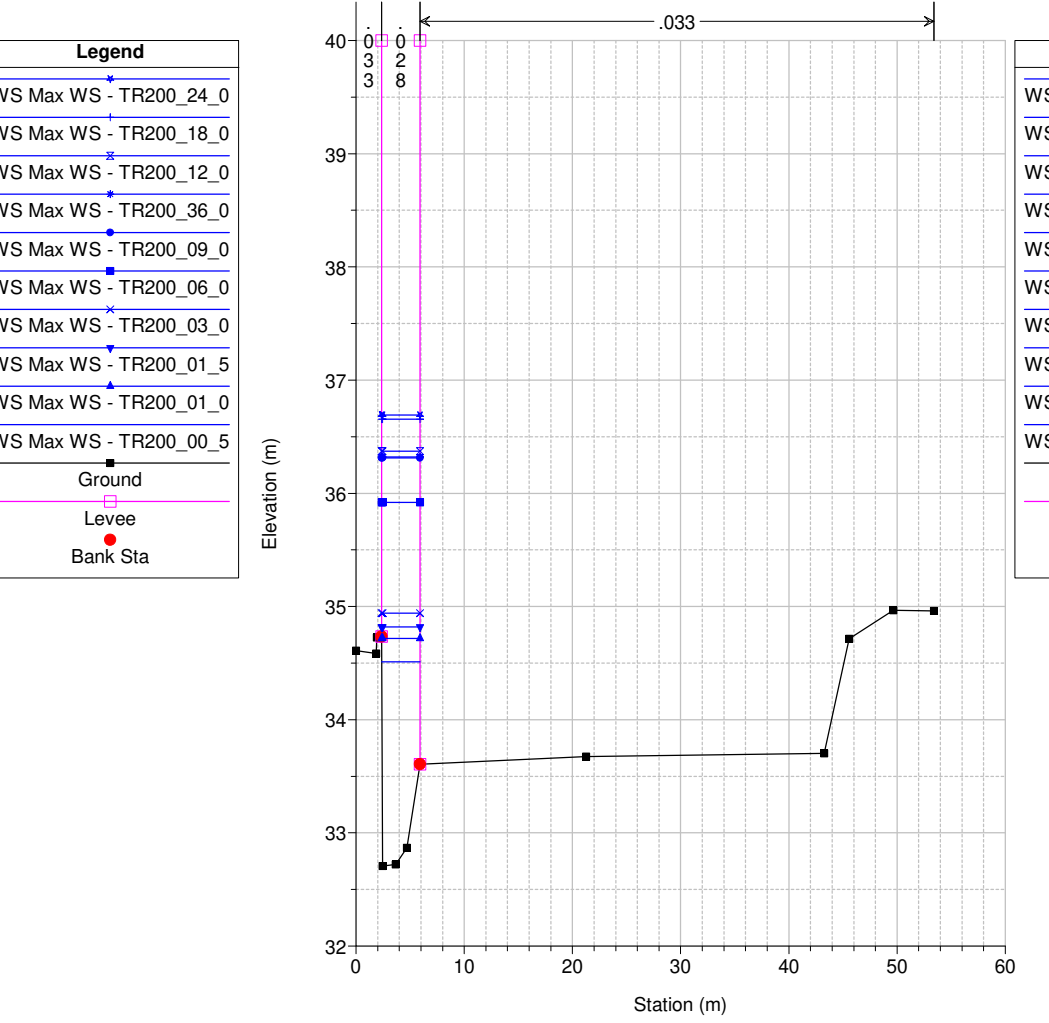

Studio Scandicci Torrenti Greve-Vingone
River = Fosso Stagno Reach = Stagno RS = 31 SG0036

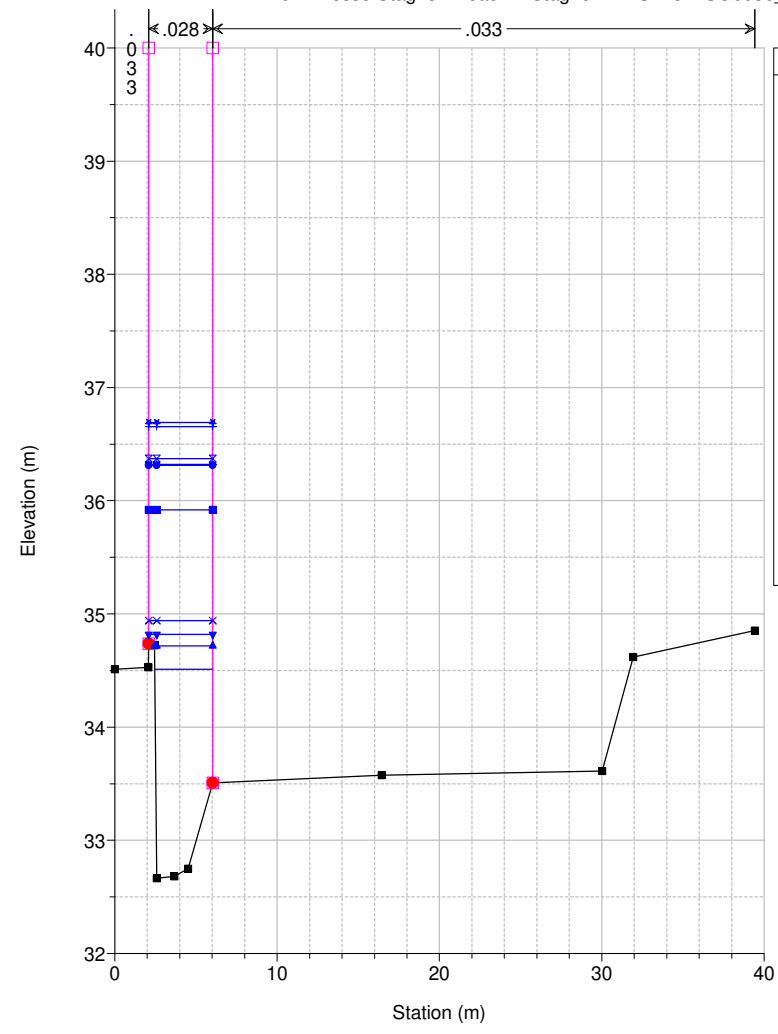

Studio Scandicci Torrenti Greve-Vingone
River = Fosso Stagno Reach = Stagno RS = 30 SG0037

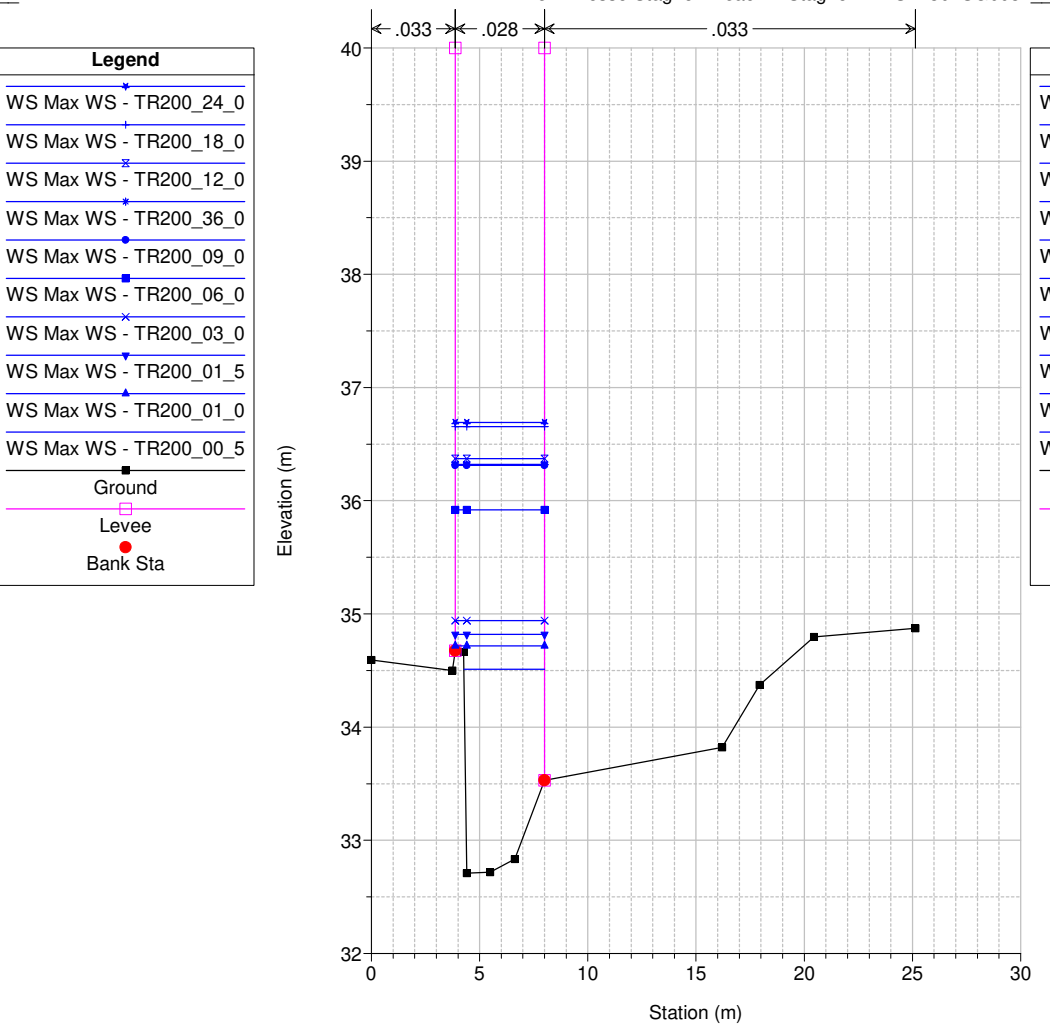

Studio Scandicci Torrenti Greve-Vingone
River = Fosso Stagno Reach = Stagno RS = 29 SG0038_A

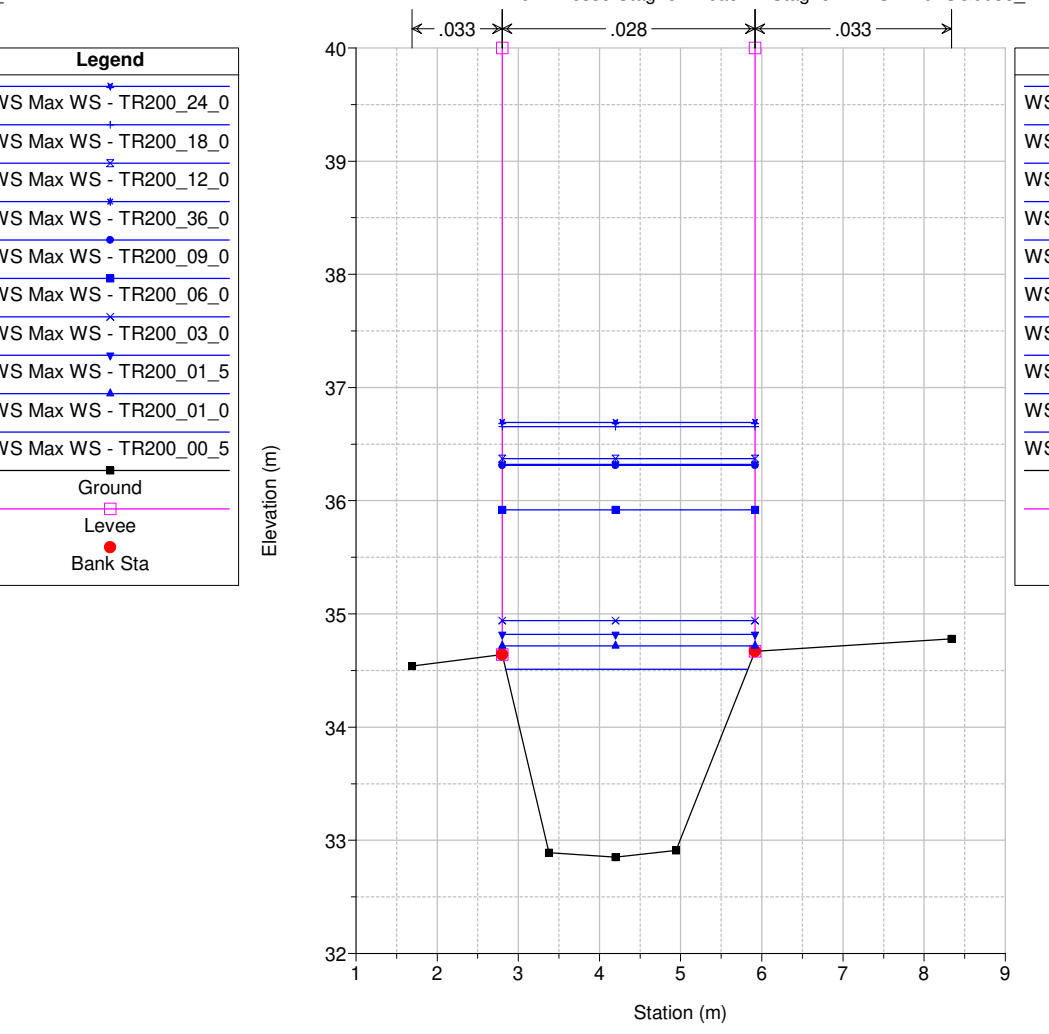

Studio Scandicci Torrenti Greve-Vingone
River = Fosso Stagno Reach = Stagno RS = 28 SG0038_B

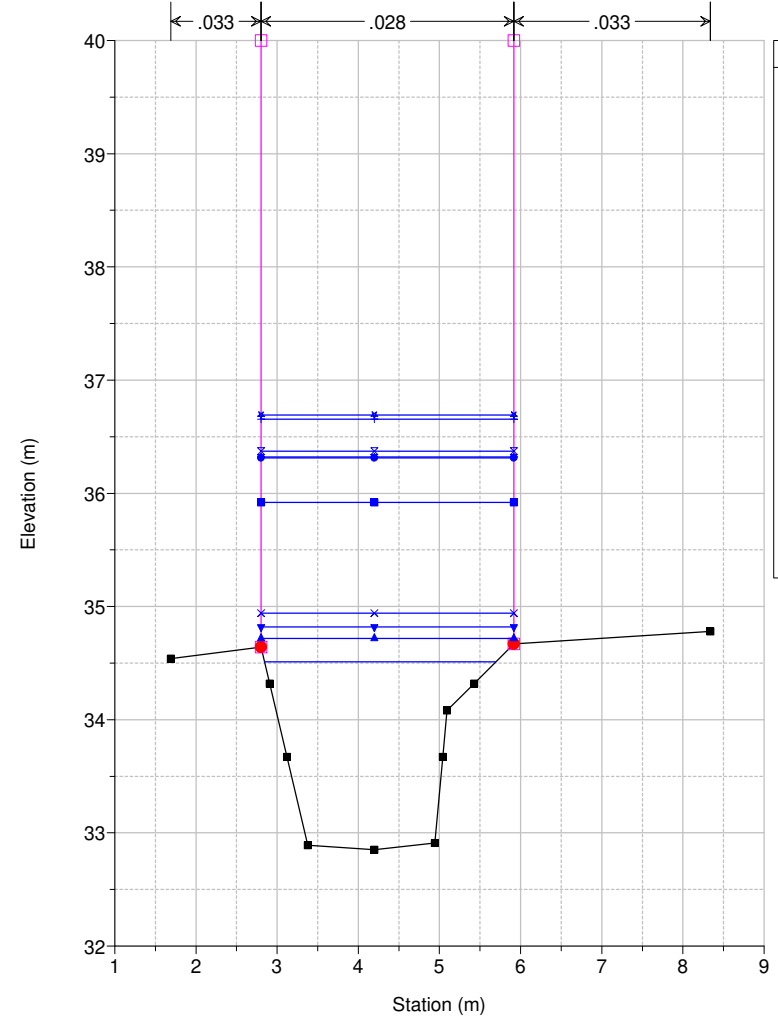

Legend

- WS Max WS - TR200_24_0
- WS Max WS - TR200_18_0
- WS Max WS - TR200_12_0
- WS Max WS - TR200_36_0
- WS Max WS - TR200_09_0
- WS Max WS - TR200_06_0
- WS Max WS - TR200_03_0
- WS Max WS - TR200_01_5
- WS Max WS - TR200_01_0
- WS Max WS - TR200_00_5
- Ground
- Levee
- Bank Sta

Studio Scandicci Torrenti Greve-Vingone
River = Fosso Stagno Reach = Stagno RS = 27.5 BR

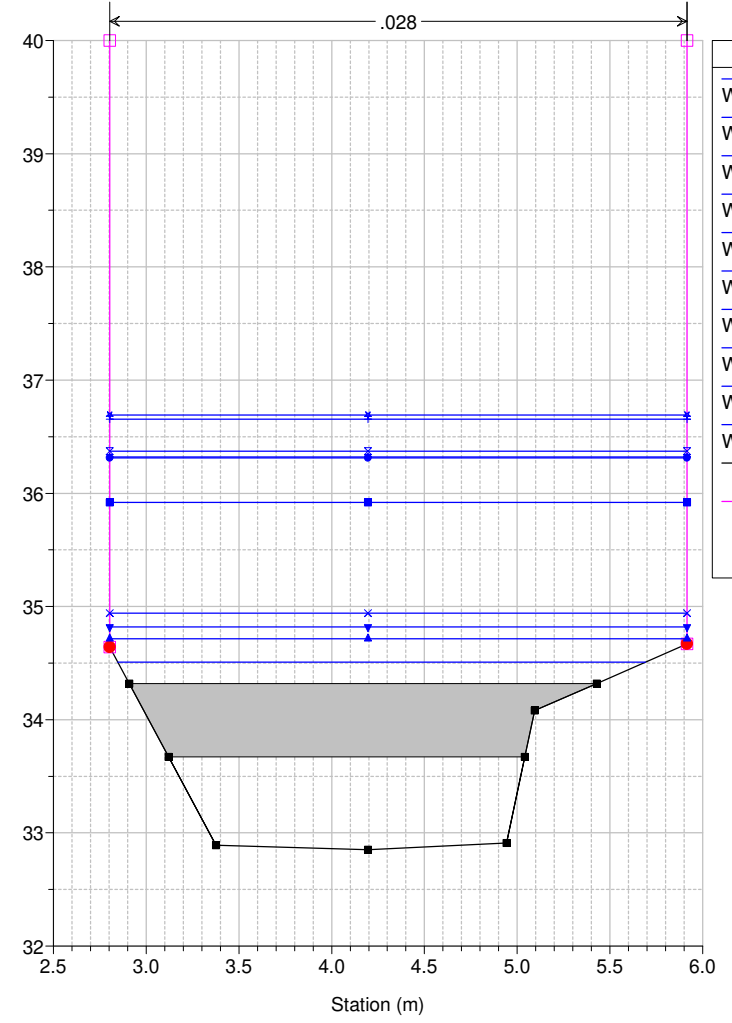

Legend

- WS Max WS - TR200_24_0
- WS Max WS - TR200_18_0
- WS Max WS - TR200_12_0
- WS Max WS - TR200_36_0
- WS Max WS - TR200_09_0
- WS Max WS - TR200_06_0
- WS Max WS - TR200_03_0
- WS Max WS - TR200_01_5
- WS Max WS - TR200_01_0
- WS Max WS - TR200_00_5
- Ground
- Levee
- Bank Sta

Studio Scandicci Torrenti Greve-Vingone
River = Fosso Stagno Reach = Stagno RS = 27.5 BR

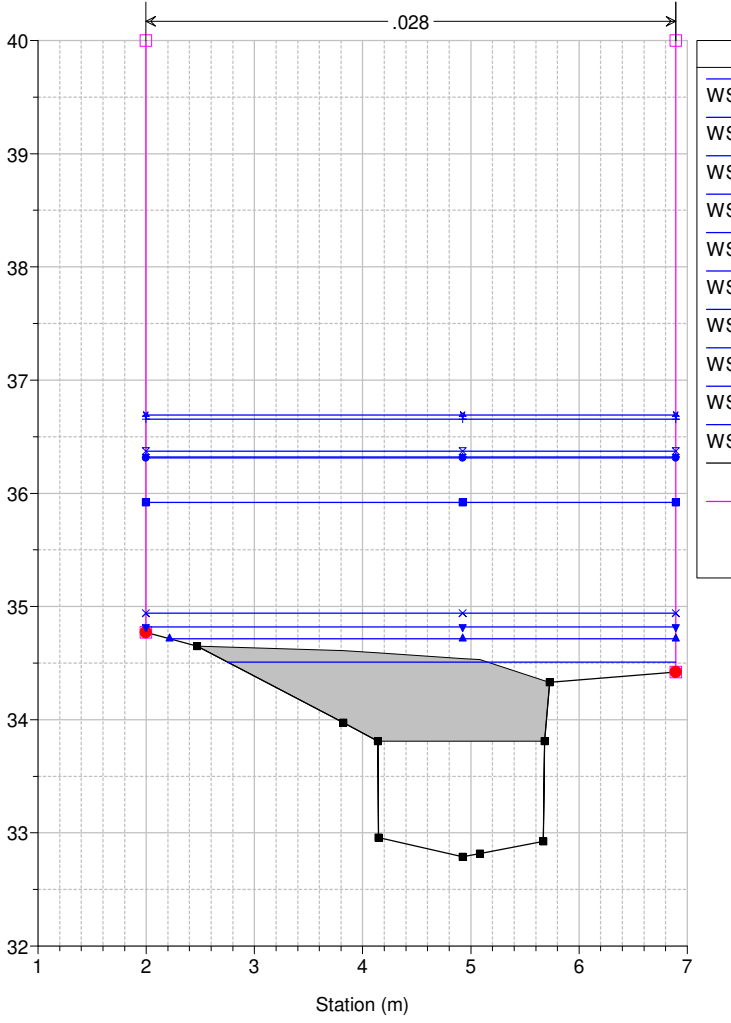

Legend

- WS Max WS - TR200_24_0
- WS Max WS - TR200_18_0
- WS Max WS - TR200_12_0
- WS Max WS - TR200_36_0
- WS Max WS - TR200_09_0
- WS Max WS - TR200_06_0
- WS Max WS - TR200_03_0
- WS Max WS - TR200_01_5
- WS Max WS - TR200_01_0
- WS Max WS - TR200_00_5
- Ground
- Levee
- Bank Sta

Studio Scandicci Torrenti Greve-Vingone
River = Fosso Stagno Reach = Stagno RS = 27 SG0038_C

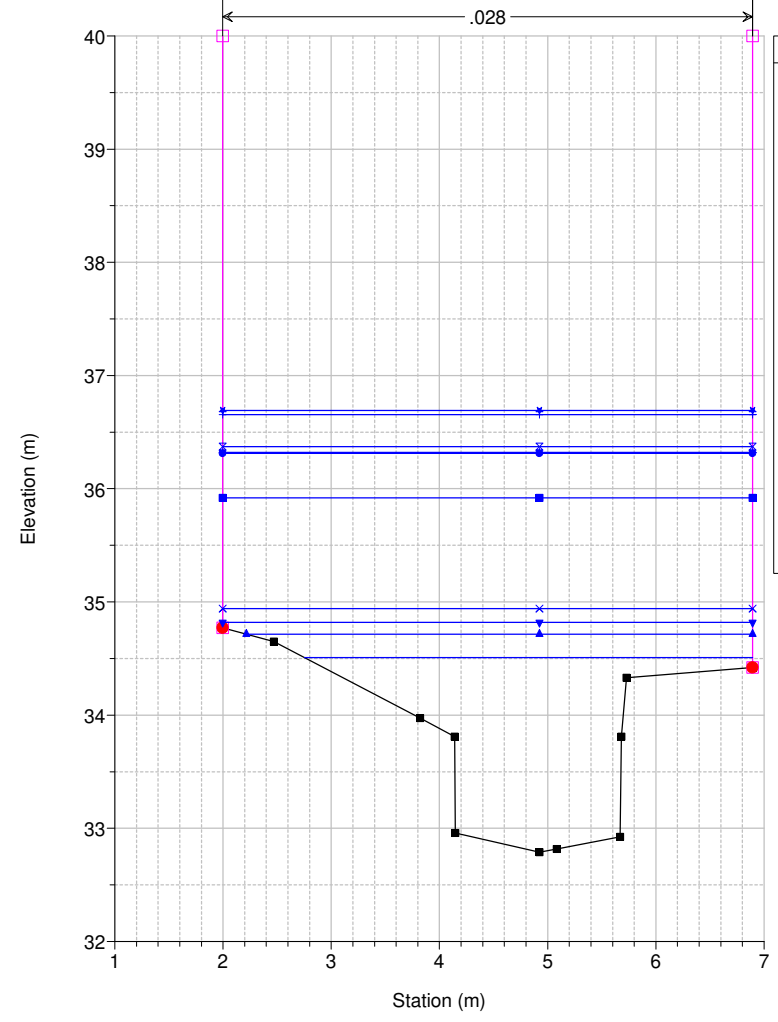

Legend

- WS Max WS - TR200_24_0
- WS Max WS - TR200_18_0
- WS Max WS - TR200_12_0
- WS Max WS - TR200_36_0
- WS Max WS - TR200_09_0
- WS Max WS - TR200_06_0
- WS Max WS - TR200_03_0
- WS Max WS - TR200_01_5
- WS Max WS - TR200_01_0
- WS Max WS - TR200_00_5
- Ground
- Levee
- Bank Sta

Studio Scandicci Torrenti Greve-Vingone
River = Fosso Stagno Reach = Stagno RS = 26 SG0038_D

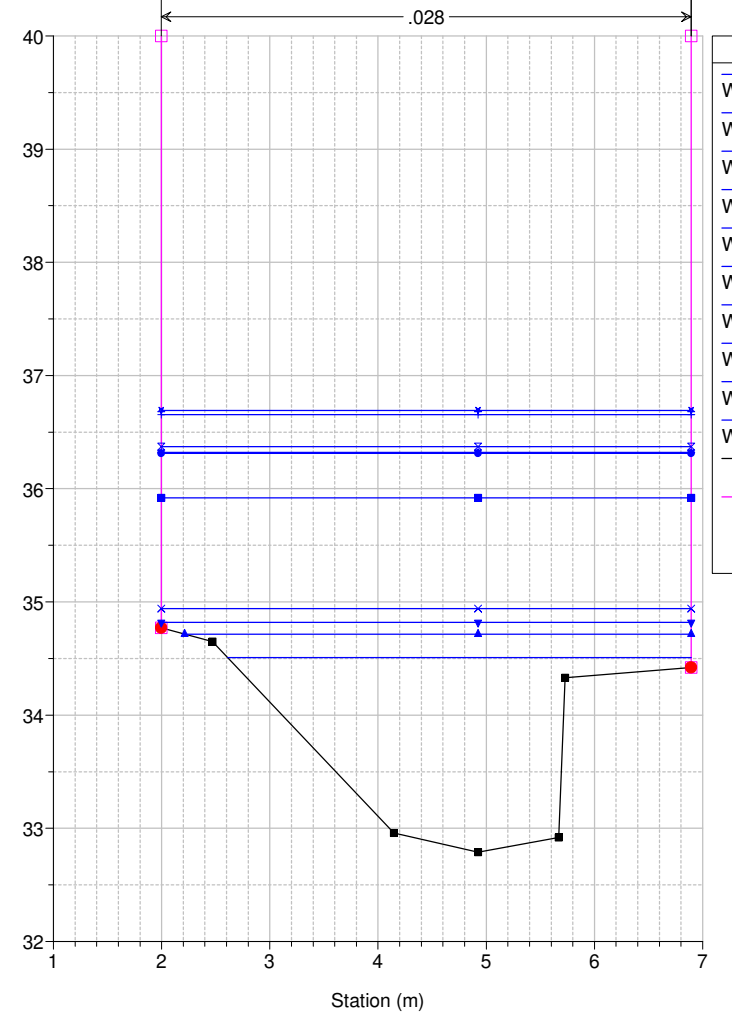

Legend

- WS Max WS - TR200_24_0
- WS Max WS - TR200_18_0
- WS Max WS - TR200_12_0
- WS Max WS - TR200_36_0
- WS Max WS - TR200_09_0
- WS Max WS - TR200_06_0
- WS Max WS - TR200_03_0
- WS Max WS - TR200_01_5
- WS Max WS - TR200_01_0
- WS Max WS - TR200_00_5
- Ground
- Levee
- Bank Sta

Studio Scandicci Torrenti Greve-Vingone
River = Fosso Stagno Reach = Stagno RS = 25 SG0039_A

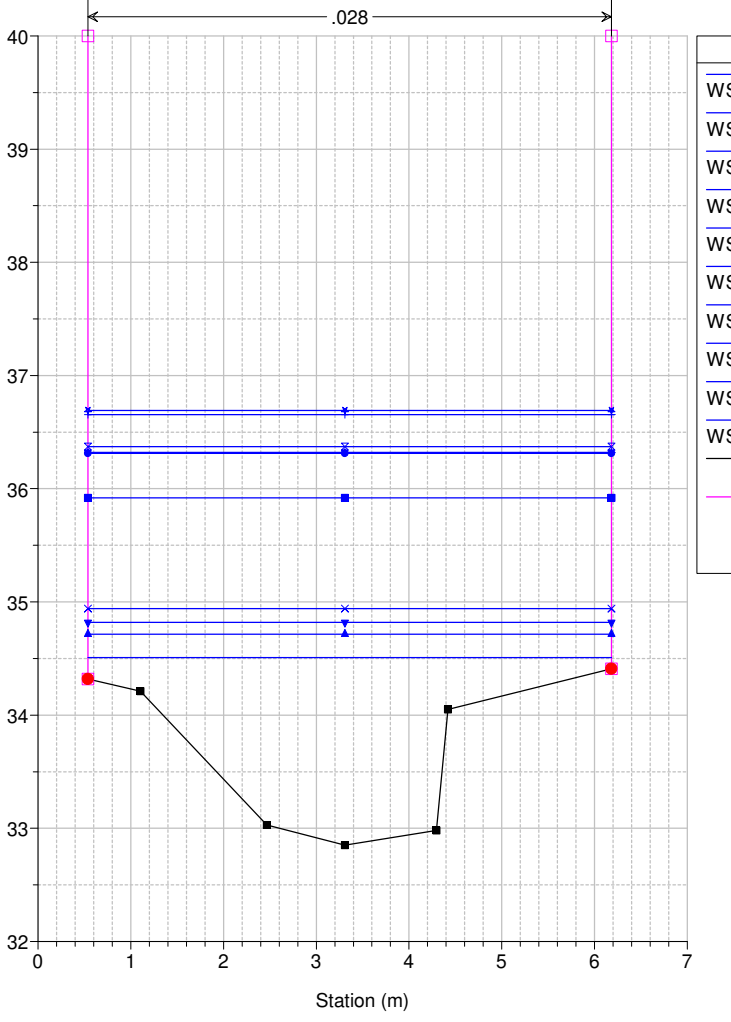

Legend

- WS Max WS - TR200_24_0
- WS Max WS - TR200_18_0
- WS Max WS - TR200_12_0
- WS Max WS - TR200_36_0
- WS Max WS - TR200_09_0
- WS Max WS - TR200_06_0
- WS Max WS - TR200_03_0
- WS Max WS - TR200_01_5
- WS Max WS - TR200_01_0
- WS Max WS - TR200_00_5
- Ground
- Levee
- Bank Sta

Studio Scandicci Torrenti Greve-Vingone
River = Fosso Stagno Reach = Stagno RS = 24 SG0039_B

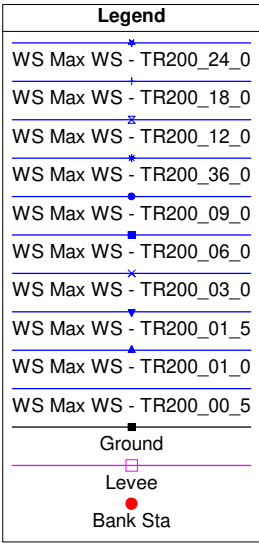
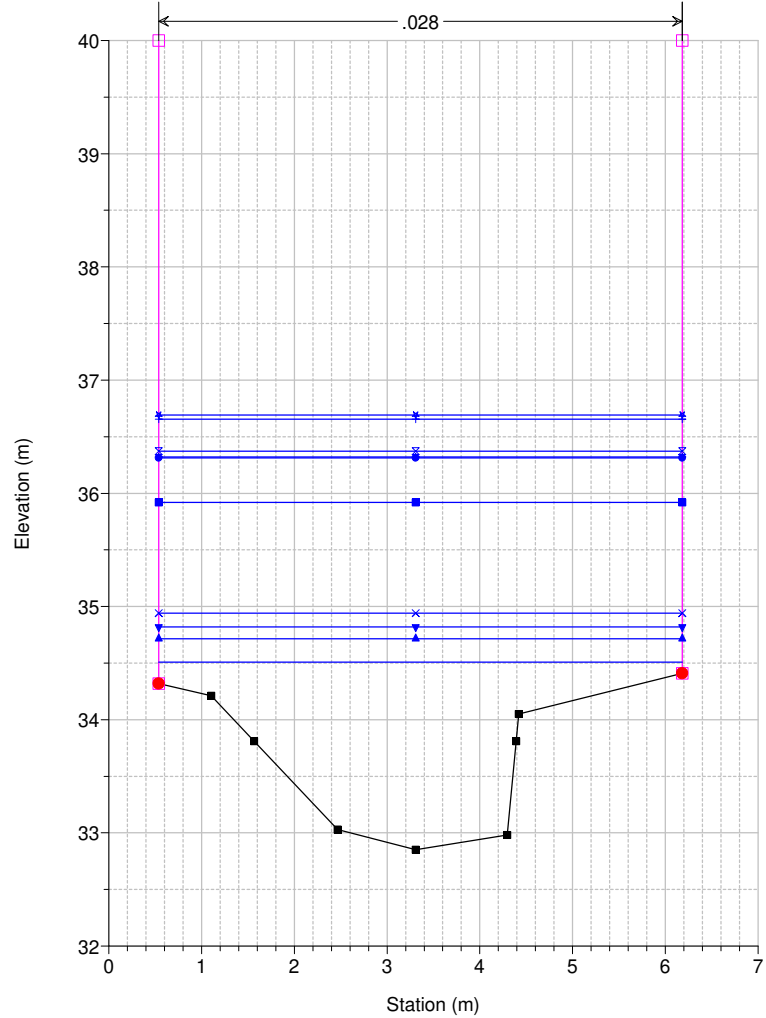

Studio Scandicci Torrenti Greve-Vingone
River = Fosso Stagno Reach = Stagno RS = 23.5 BR

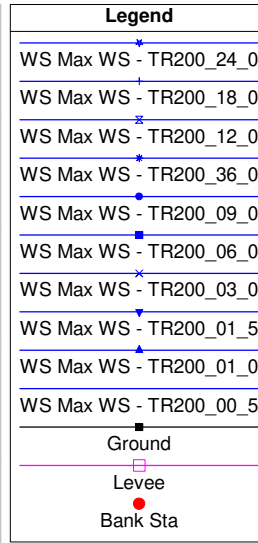
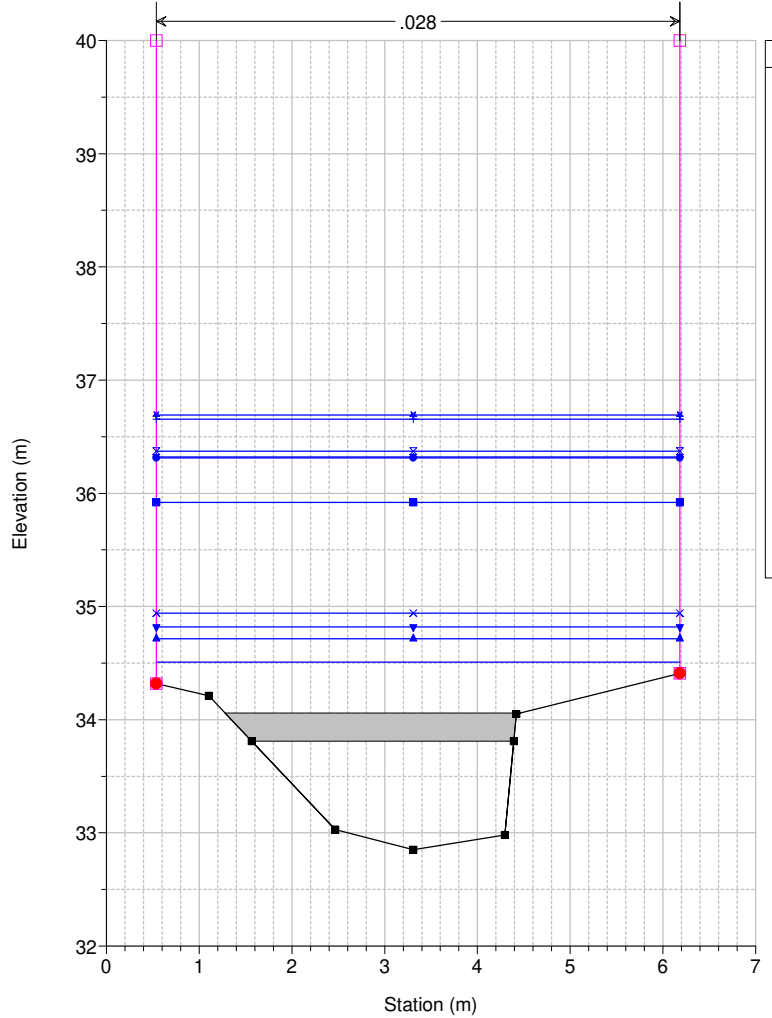

Studio Scandicci Torrenti Greve-Vingone
River = Fosso Stagno Reach = Stagno RS = 23.5 BR

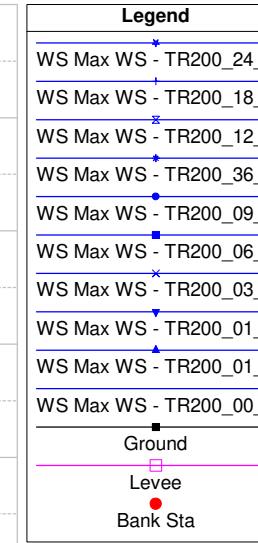
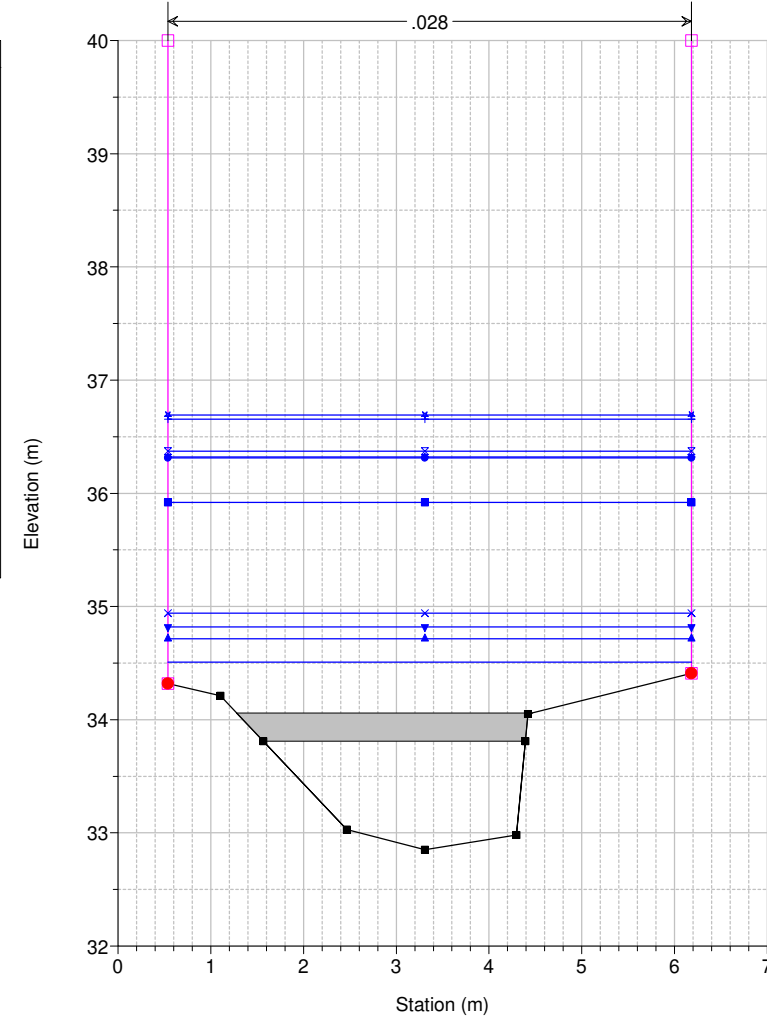

Studio Scandicci Torrenti Greve-Vingone
River = Fosso Stagno Reach = Stagno RS = 23 SG0039_C

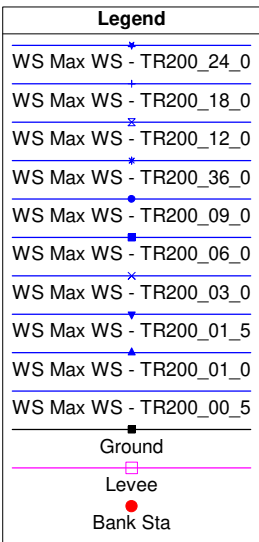
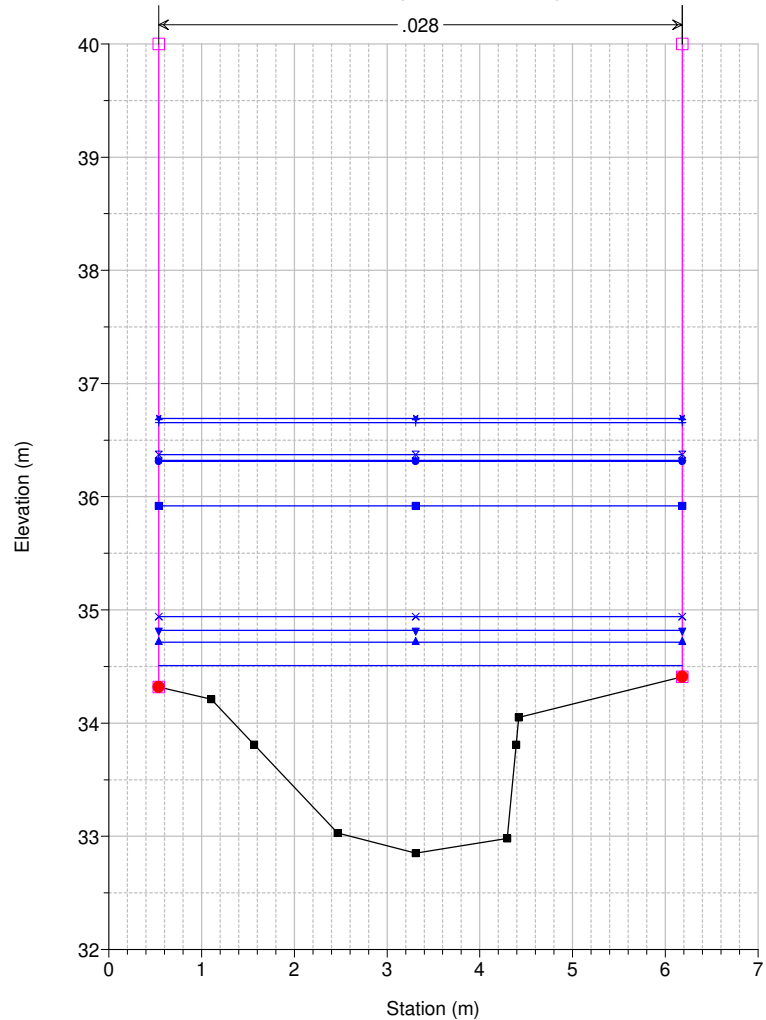

Studio Scandicci Torrenti Greve-Vingone
River = Fosso Stagno Reach = Stagno RS = 22 SG0039_D

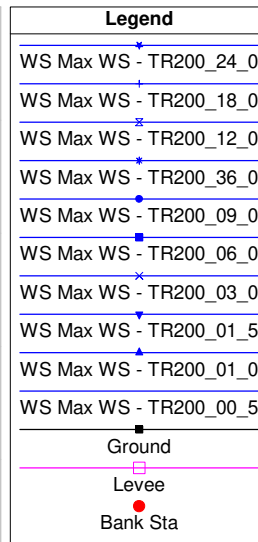
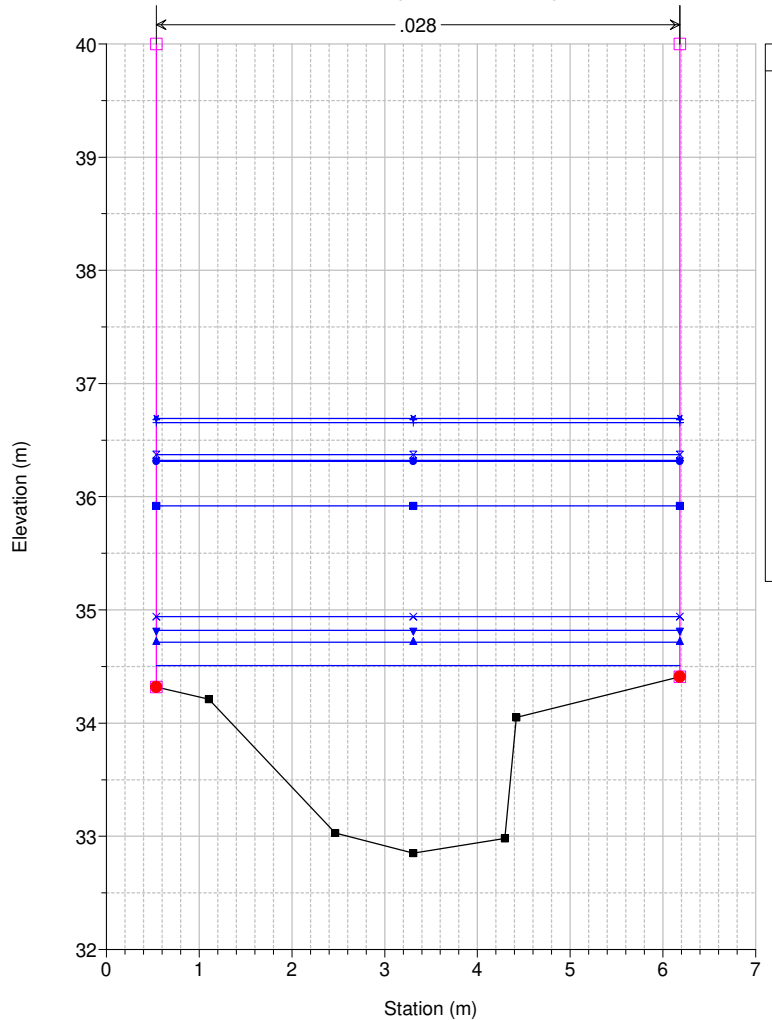

Studio Scandicci Torrenti Greve-Vingone
River = Fosso Stagno Reach = Stagno RS = 21 SG0040_

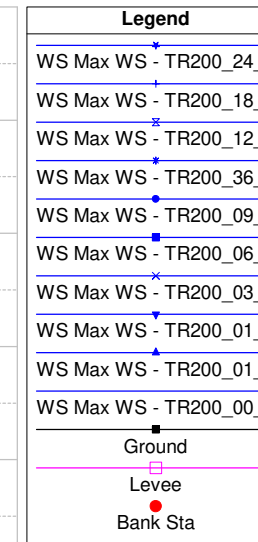
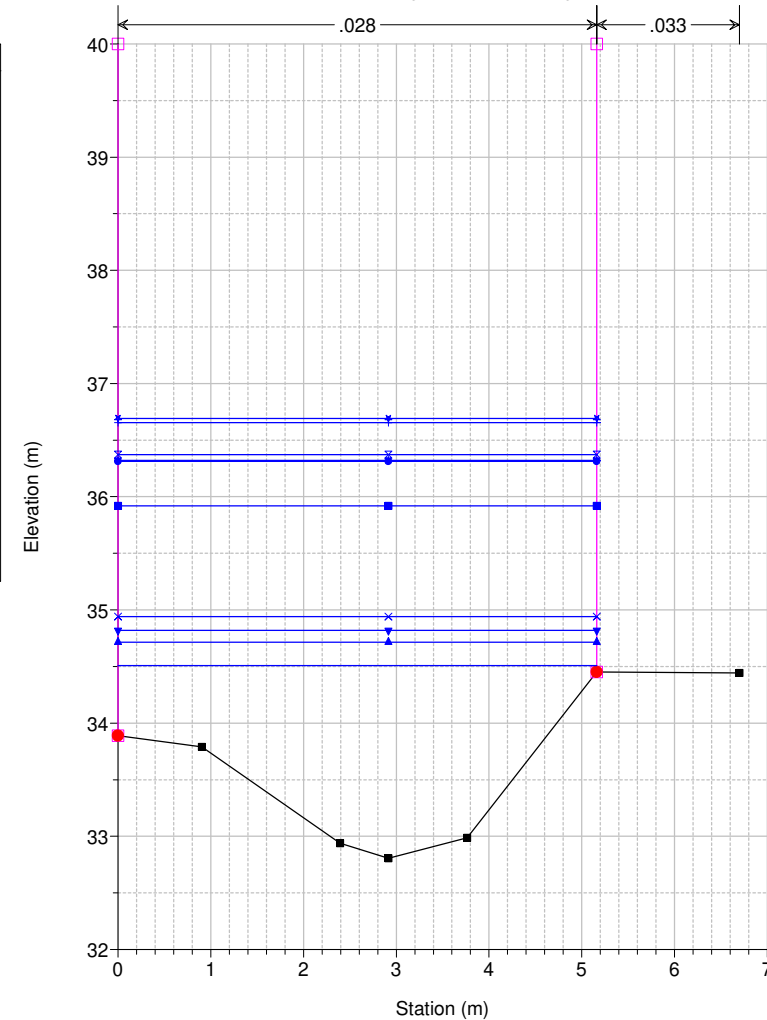

Studio Scandicci Torrenti Greve-Vingone
River = Fosso Stagno Reach = Stagno RS = 20 SG0041__

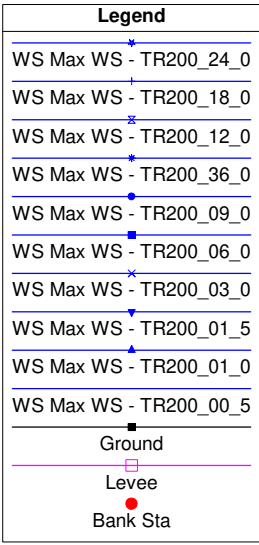
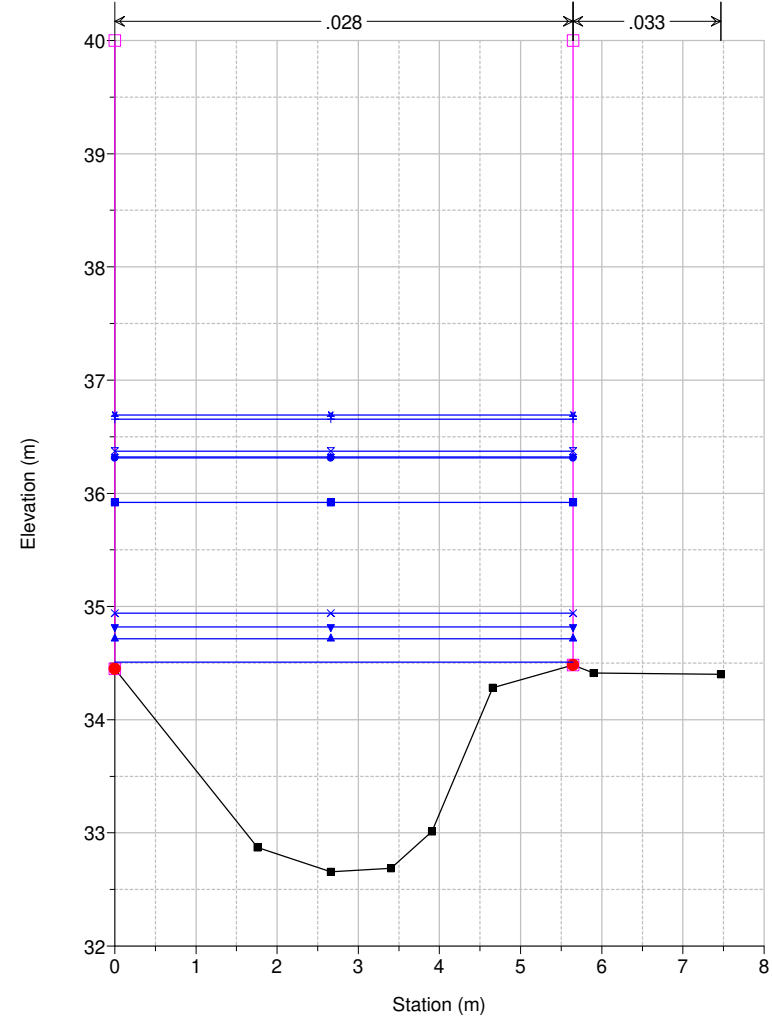

Studio Scandicci Torrenti Greve-Vingone
River = Fosso Stagno Reach = Stagno RS = 19 SG0042__

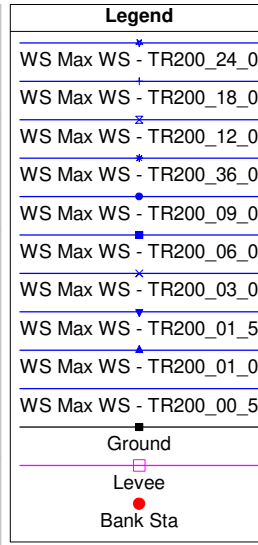
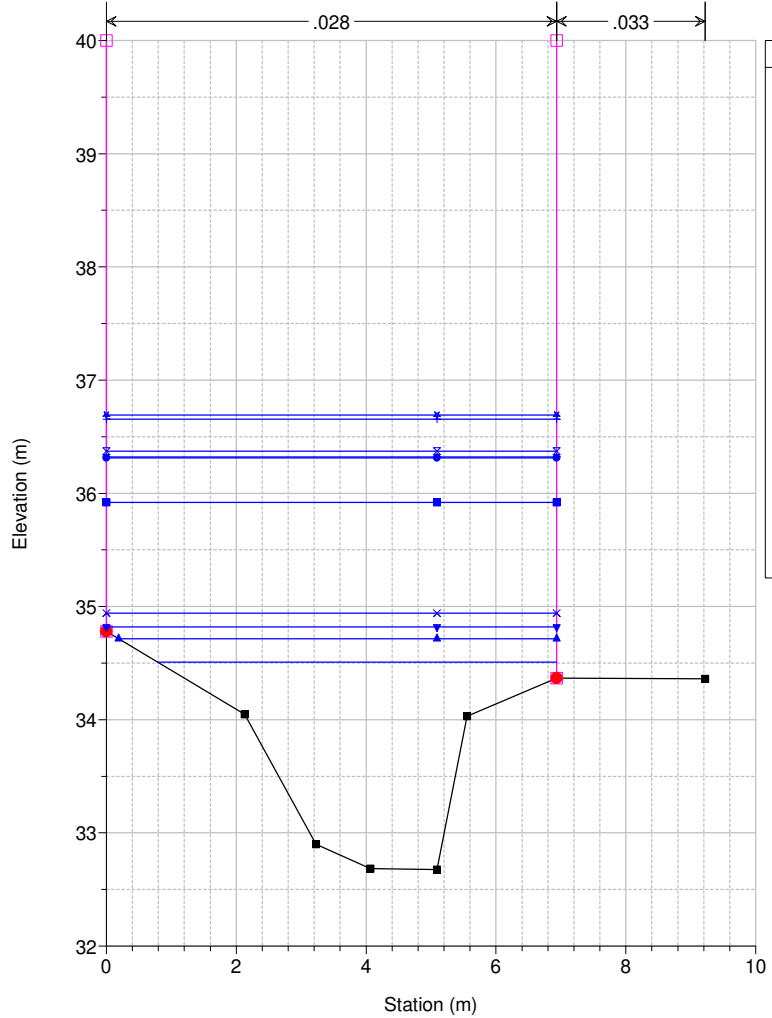

Studio Scandicci Torrenti Greve-Vingone
River = Fosso Stagno Reach = Stagno RS = 18 SG0043__

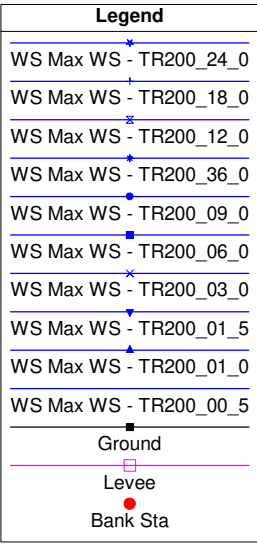
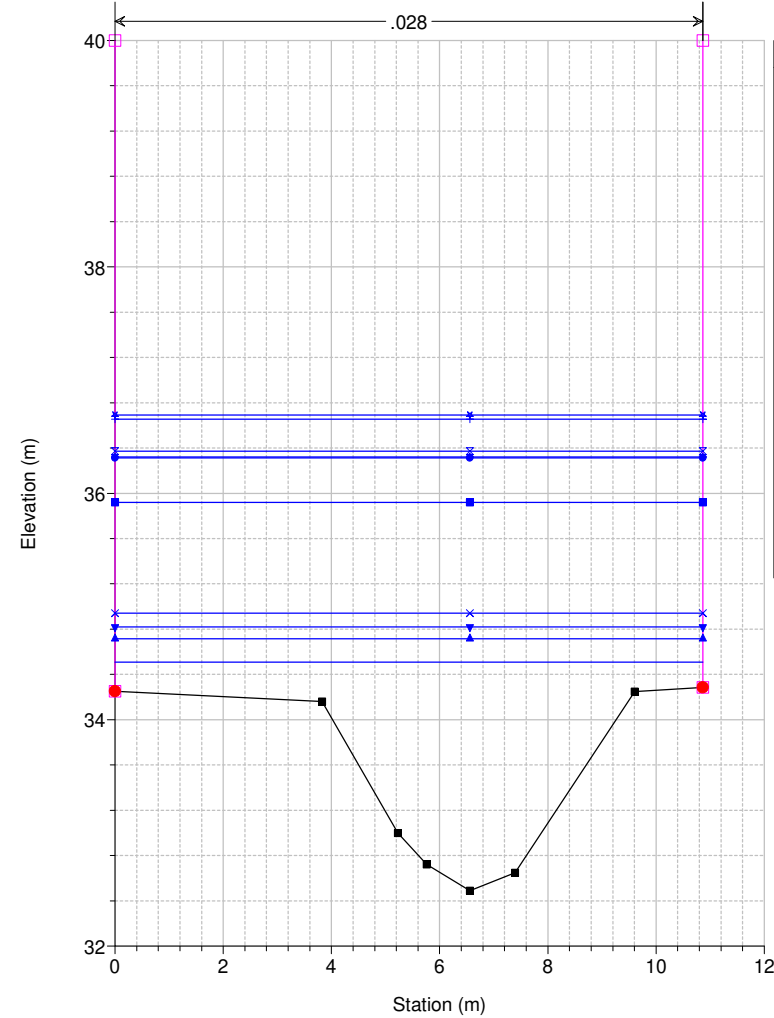

Studio Scandicci Torrenti Greve-Vingone
River = Fosso Stagno Reach = Stagno RS = 17 SG0044__

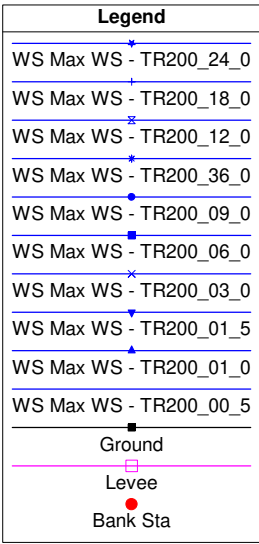
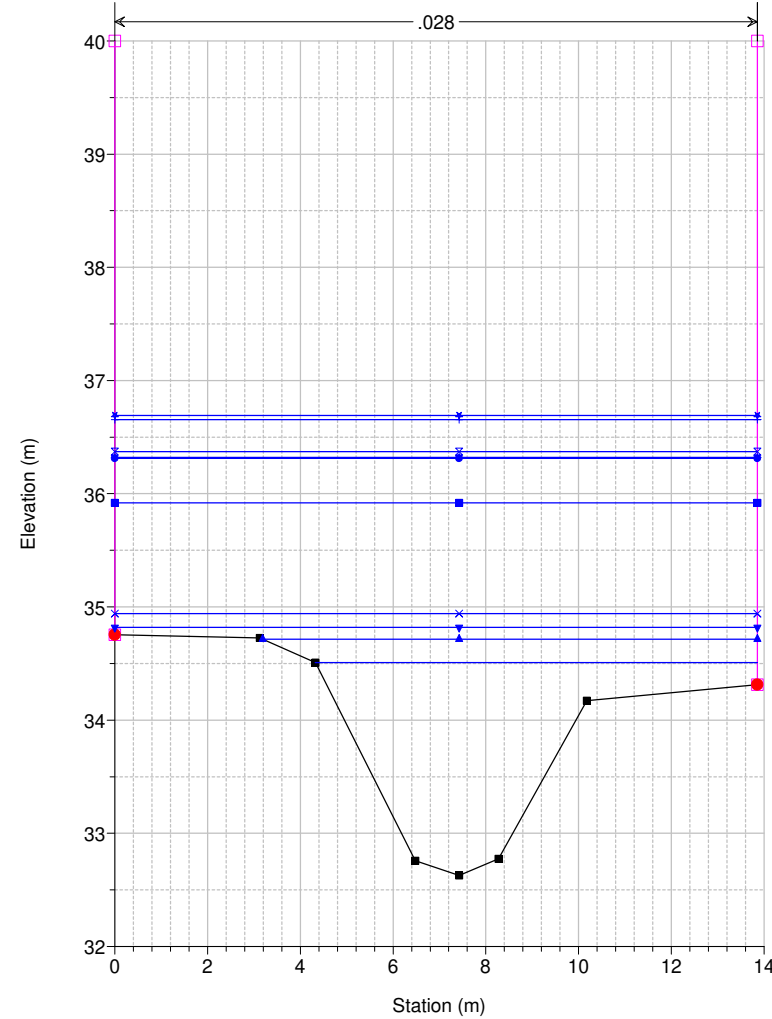

Studio Scandicci Torrenti Greve-Vingone
River = Fosso Stagno Reach = Stagno RS = 16 SG0045__

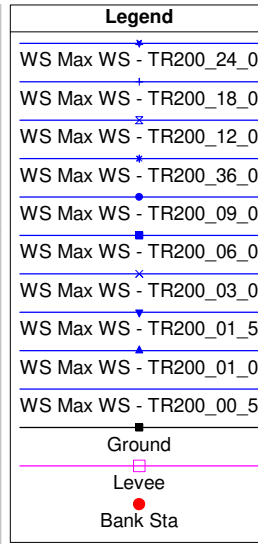
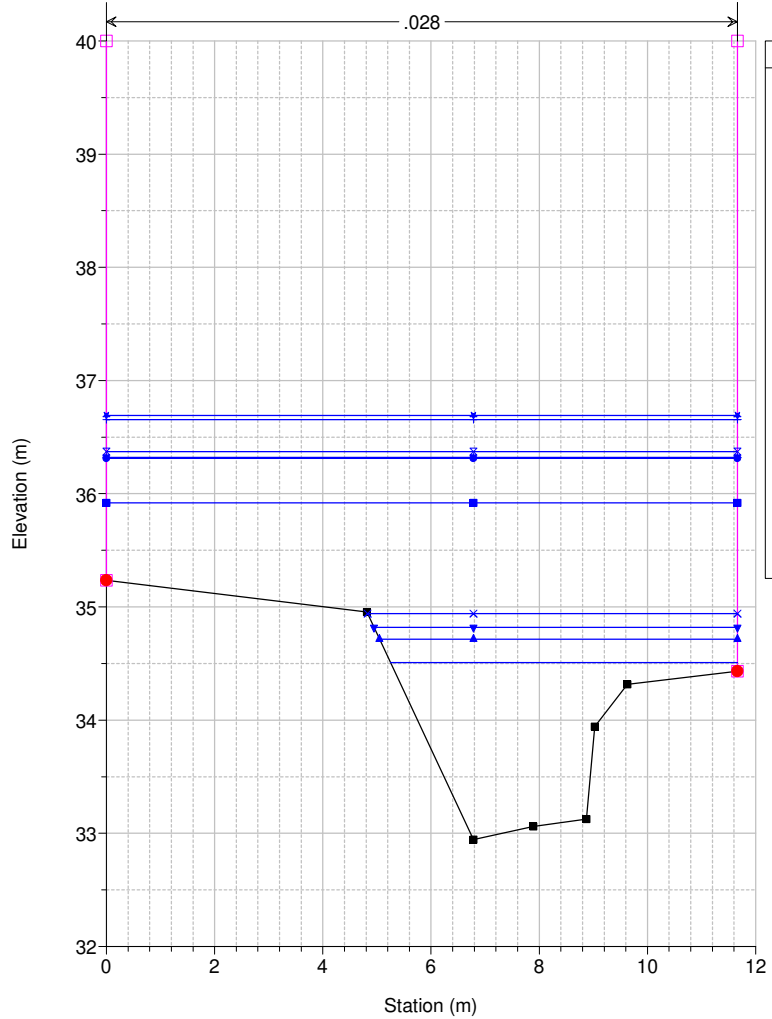

Studio Scandicci Torrenti Greve-Vingone
River = Fosso Stagno Reach = Stagno RS = 15 SG0046_A

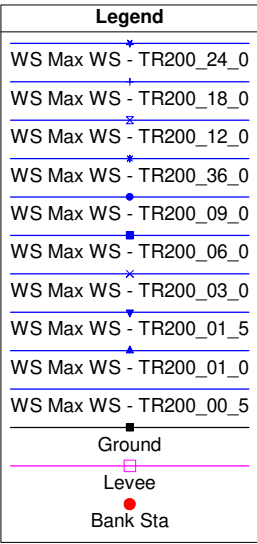
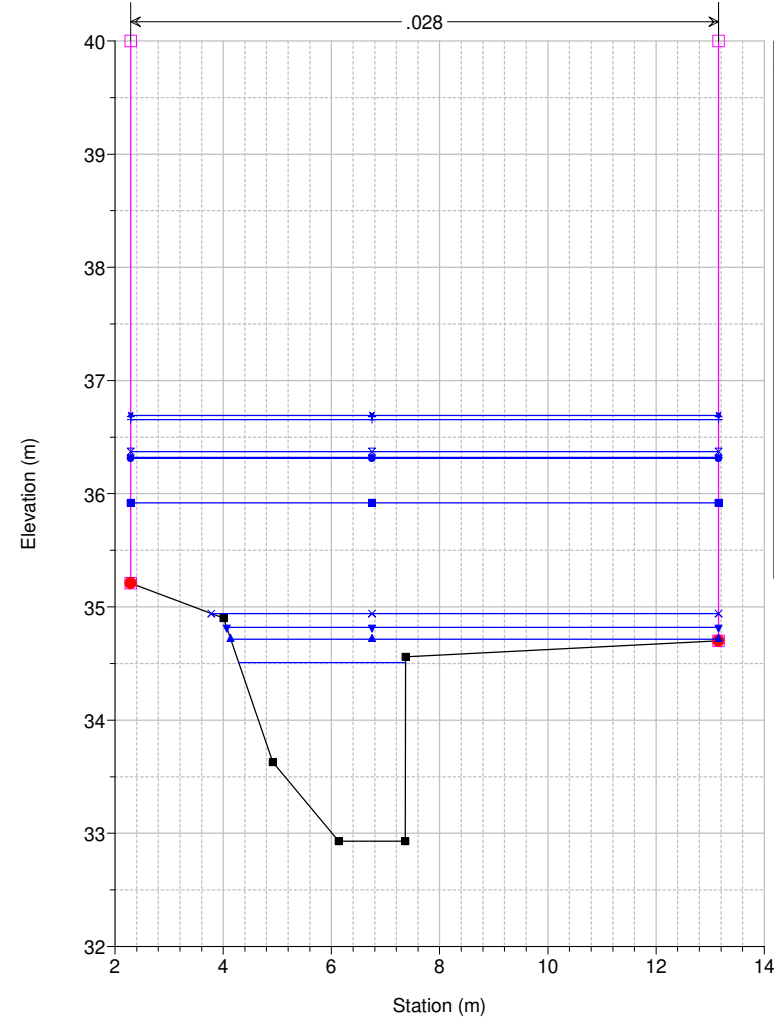

Studio Scandicci Torrenti Greve-Vingone
River = Fosso Stagno Reach = Stagno RS = 14 SG0046_B

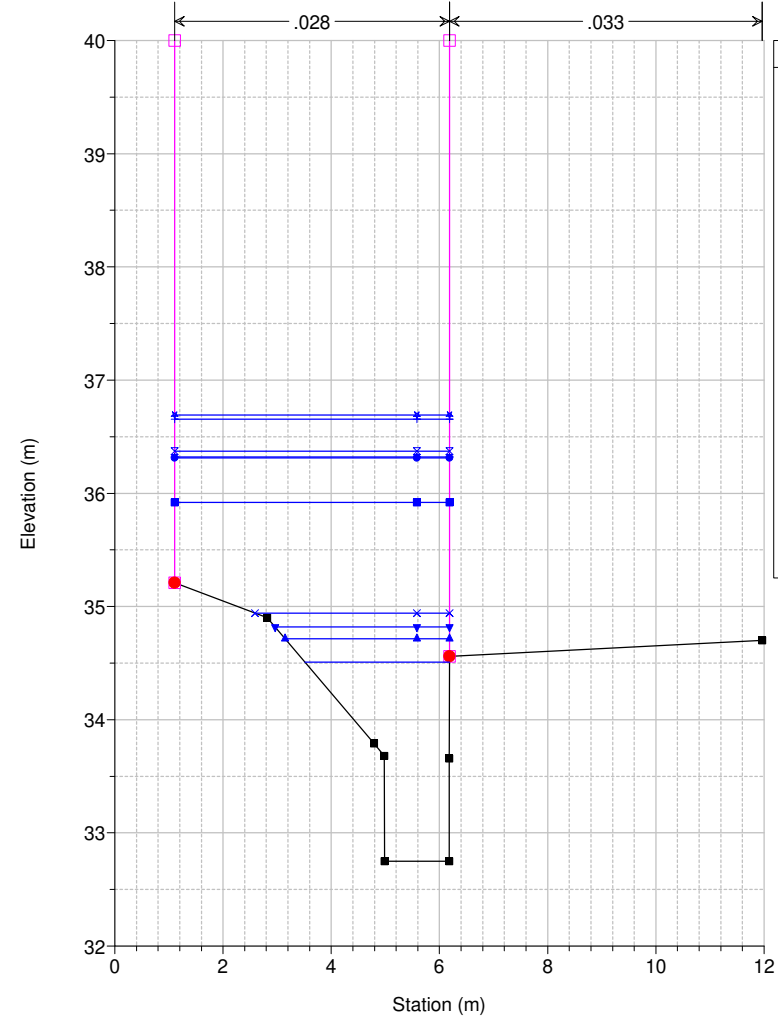

Legend

- WS Max WS - TR200_24_0
- WS Max WS - TR200_18_0
- WS Max WS - TR200_12_0
- WS Max WS - TR200_36_0
- WS Max WS - TR200_09_0
- WS Max WS - TR200_06_0
- WS Max WS - TR200_03_0
- WS Max WS - TR200_01_5
- WS Max WS - TR200_01_0
- WS Max WS - TR200_00_5
- Ground
- Levee
- Bank Sta

Studio Scandicci Torrenti Greve-Vingone
River = Fosso Stagno Reach = Stagno RS = 13.5 BR

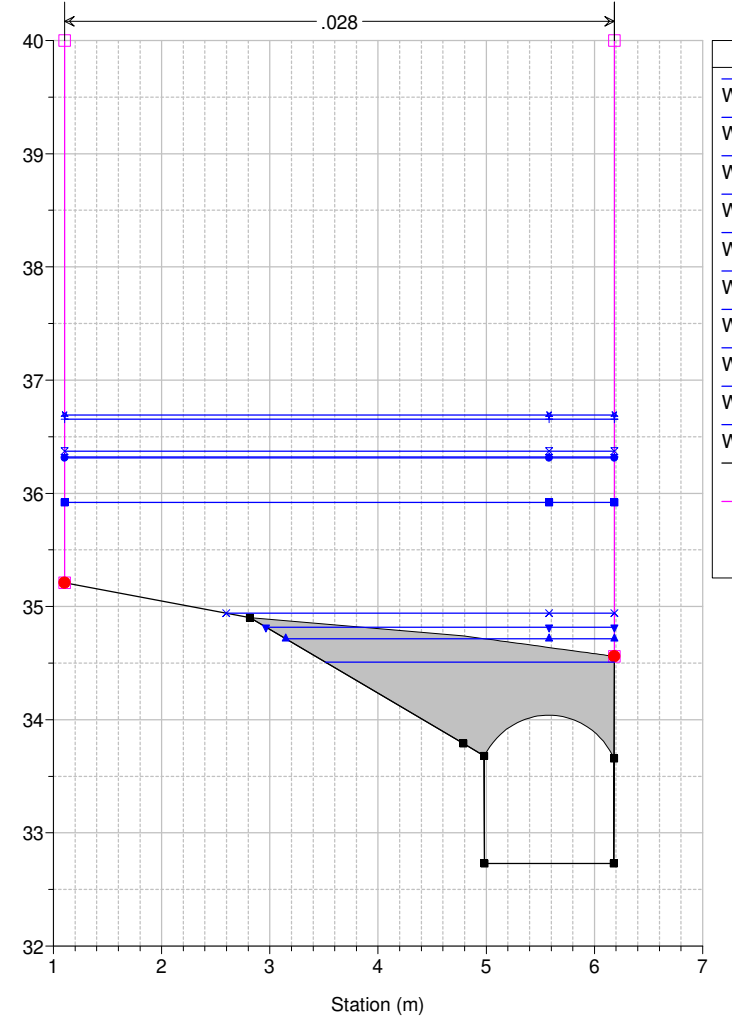

Legend

- WS Max WS - TR200_24_0
- WS Max WS - TR200_18_0
- WS Max WS - TR200_12_0
- WS Max WS - TR200_36_0
- WS Max WS - TR200_09_0
- WS Max WS - TR200_06_0
- WS Max WS - TR200_03_0
- WS Max WS - TR200_01_5
- WS Max WS - TR200_01_0
- WS Max WS - TR200_00_5
- Ground
- Levee
- Bank Sta

Studio Scandicci Torrenti Greve-Vingone
River = Fosso Stagno Reach = Stagno RS = 13.5 BR

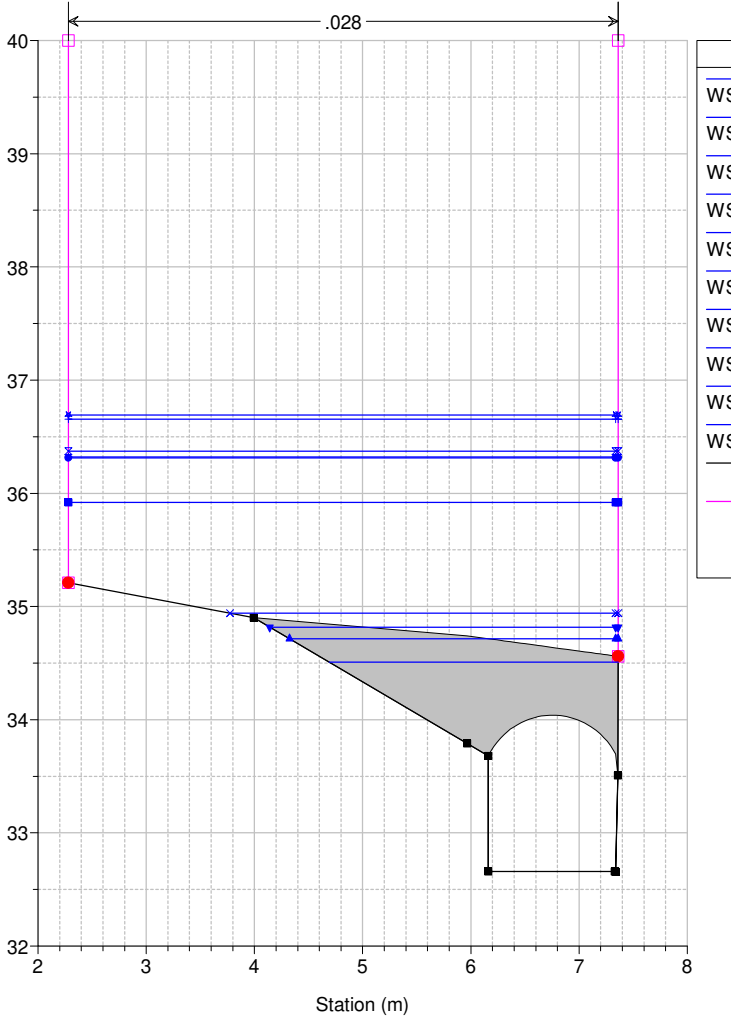

Legend

- WS Max WS - TR200_24_0
- WS Max WS - TR200_18_0
- WS Max WS - TR200_12_0
- WS Max WS - TR200_36_0
- WS Max WS - TR200_09_0
- WS Max WS - TR200_06_0
- WS Max WS - TR200_03_0
- WS Max WS - TR200_01_5
- WS Max WS - TR200_01_0
- WS Max WS - TR200_00_5
- Ground
- Levee
- Bank Sta

Studio Scandicci Torrenti Greve-Vingone
River = Fosso Stagno Reach = Stagno RS = 13 SG0046_C

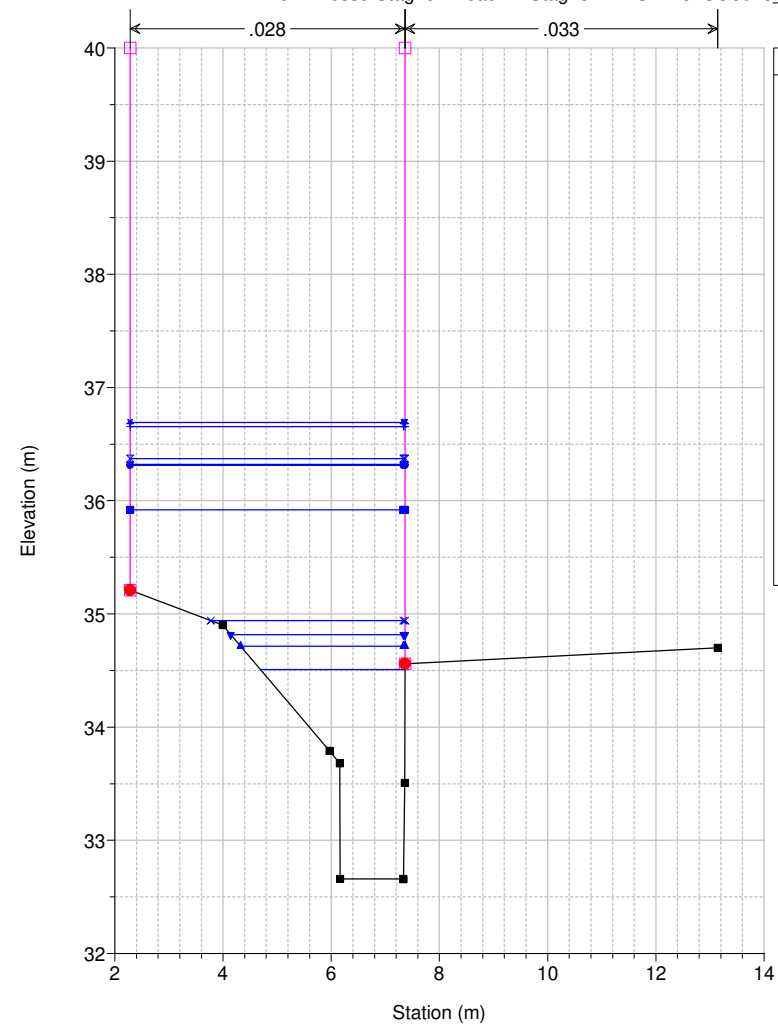

Legend

- WS Max WS - TR200_24_0
- WS Max WS - TR200_18_0
- WS Max WS - TR200_12_0
- WS Max WS - TR200_36_0
- WS Max WS - TR200_09_0
- WS Max WS - TR200_06_0
- WS Max WS - TR200_03_0
- WS Max WS - TR200_01_5
- WS Max WS - TR200_01_0
- WS Max WS - TR200_00_5
- Ground
- Levee
- Bank Sta

Studio Scandicci Torrenti Greve-Vingone
River = Fosso Stagno Reach = Stagno RS = 12 SG0046_D

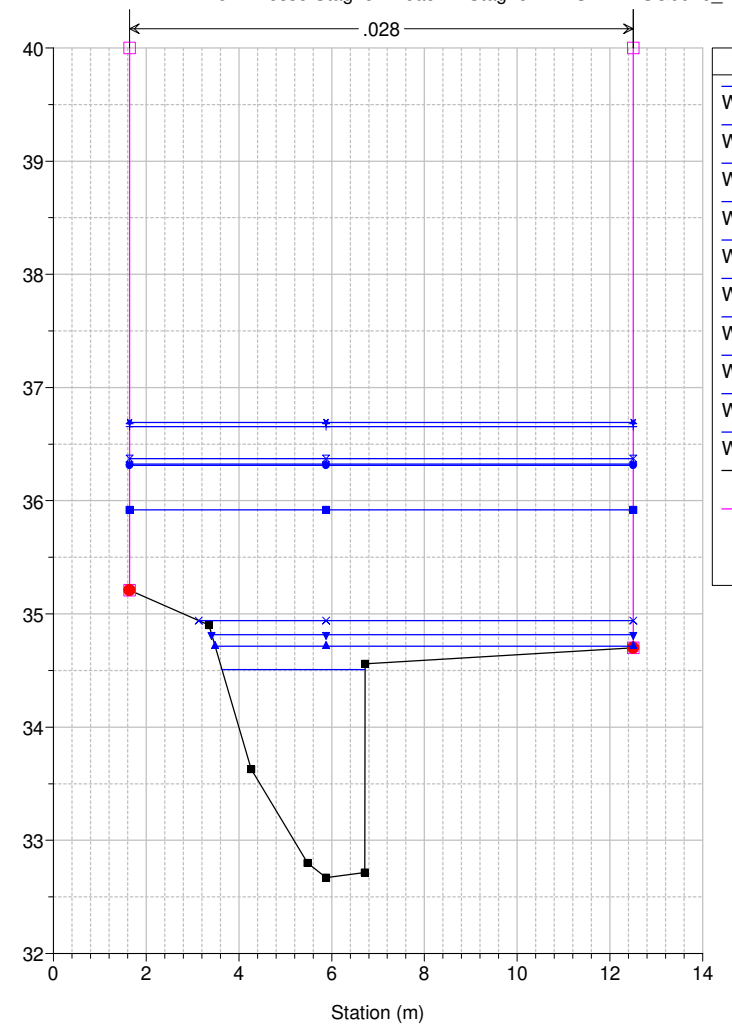

Legend

- WS Max WS - TR200_24_0
- WS Max WS - TR200_18_0
- WS Max WS - TR200_12_0
- WS Max WS - TR200_36_0
- WS Max WS - TR200_09_0
- WS Max WS - TR200_06_0
- WS Max WS - TR200_03_0
- WS Max WS - TR200_01_5
- WS Max WS - TR200_01_0
- WS Max WS - TR200_00_5
- Ground
- Levee
- Bank Sta

Studio Scandicci Torrenti Greve-Vingone
River = Fosso Stagno Reach = Stagno RS = 11 SG0047_

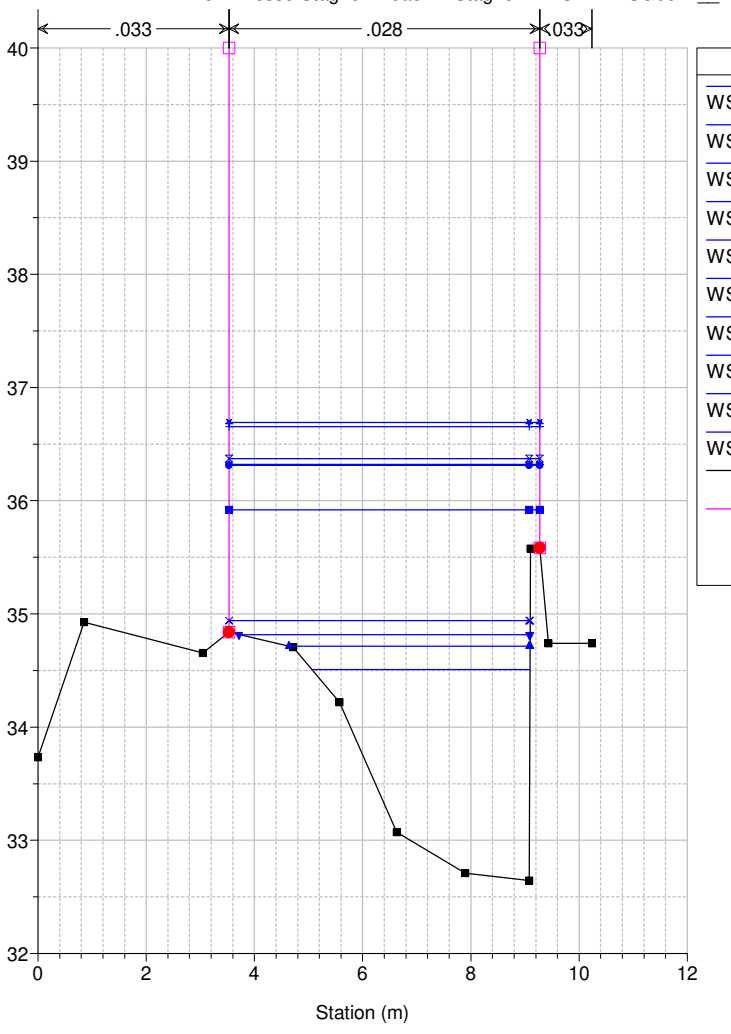

Legend

- WS Max WS - TR200_24_0
- WS Max WS - TR200_18_0
- WS Max WS - TR200_12_0
- WS Max WS - TR200_36_0
- WS Max WS - TR200_09_0
- WS Max WS - TR200_06_0
- WS Max WS - TR200_03_0
- WS Max WS - TR200_01_5
- WS Max WS - TR200_01_0
- WS Max WS - TR200_00_5
- Ground
- Levee
- Bank Sta

Studio Scandicci Torrenti Greve-Vingone
River = Fosso Stagno Reach = Stagno RS = 10 SG0048_

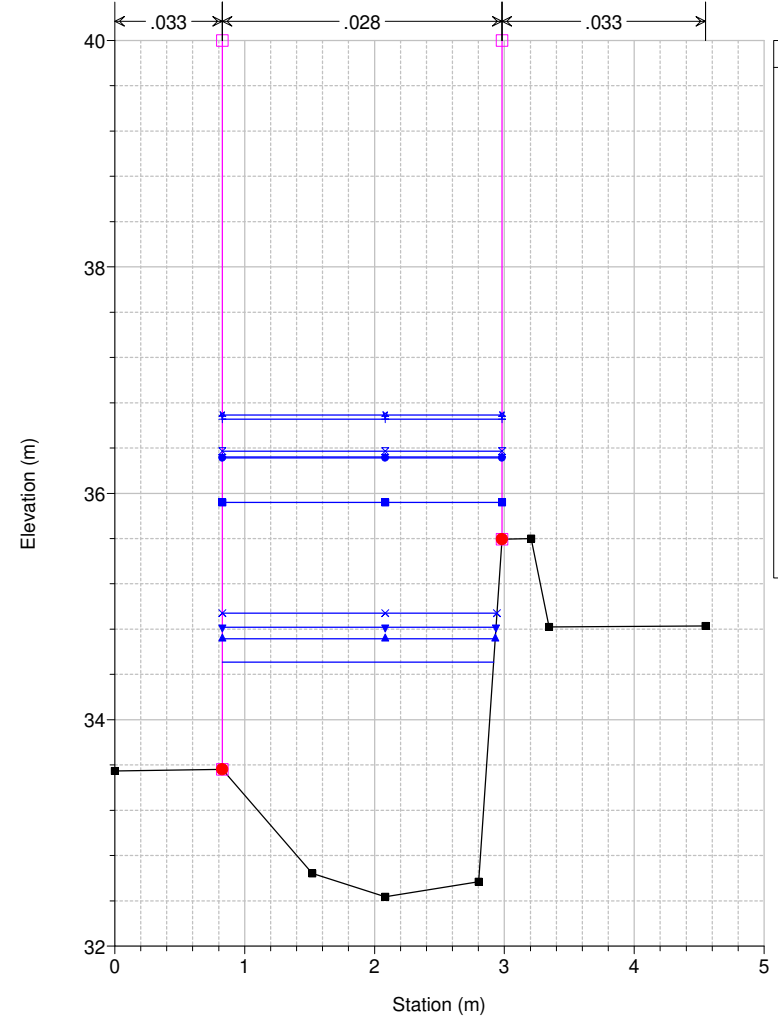

Legend

- WS Max WS - TR200_24_0
- WS Max WS - TR200_18_0
- WS Max WS - TR200_12_0
- WS Max WS - TR200_36_0
- WS Max WS - TR200_09_0
- WS Max WS - TR200_06_0
- WS Max WS - TR200_03_0
- WS Max WS - TR200_01_5
- WS Max WS - TR200_01_0
- WS Max WS - TR200_00_5
- Ground
- Levee
- Bank Sta

Studio Scandicci Torrenti Greve-Vingone
River = Fosso Stagno Reach = Stagno RS = 9 SG0049_A

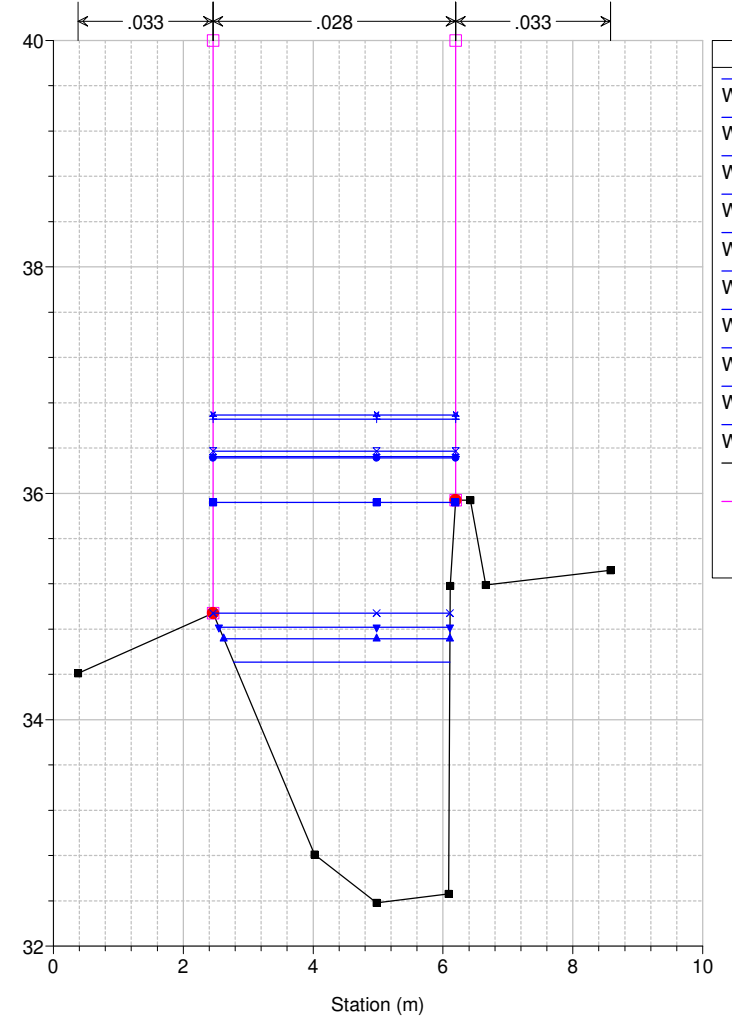

Legend

- WS Max WS - TR200_24_0
- WS Max WS - TR200_18_0
- WS Max WS - TR200_12_0
- WS Max WS - TR200_36_0
- WS Max WS - TR200_09_0
- WS Max WS - TR200_06_0
- WS Max WS - TR200_03_0
- WS Max WS - TR200_01_5
- WS Max WS - TR200_01_0
- WS Max WS - TR200_00_5
- Ground
- Levee
- Bank Sta

Studio Scandicci Torrenti Greve-Vingone
River = Fosso Stagno Reach = Stagno RS = 8 SG0049_B

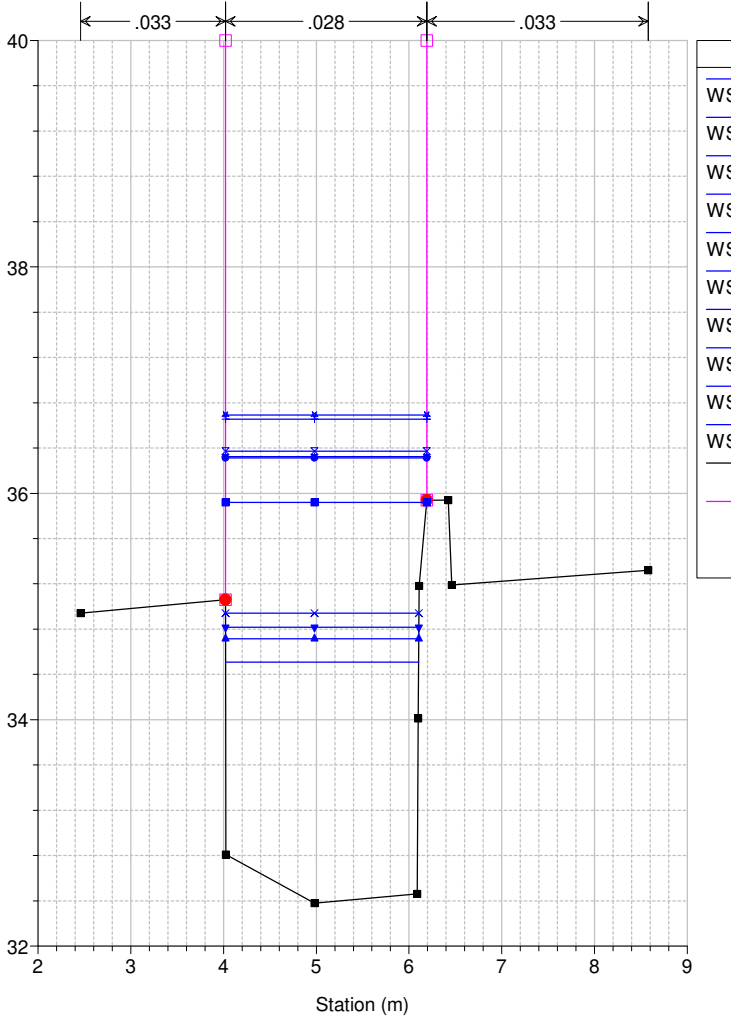

Legend

- WS Max WS - TR200_24_0
- WS Max WS - TR200_18_0
- WS Max WS - TR200_12_0
- WS Max WS - TR200_36_0
- WS Max WS - TR200_09_0
- WS Max WS - TR200_06_0
- WS Max WS - TR200_03_0
- WS Max WS - TR200_01_5
- WS Max WS - TR200_01_0
- WS Max WS - TR200_00_5
- Ground
- Levee
- Bank Sta

Studio Scandicci Torrenti Greve-Vingone
River = Fosso Stagno Reach = Stagno RS = 7.5 BR

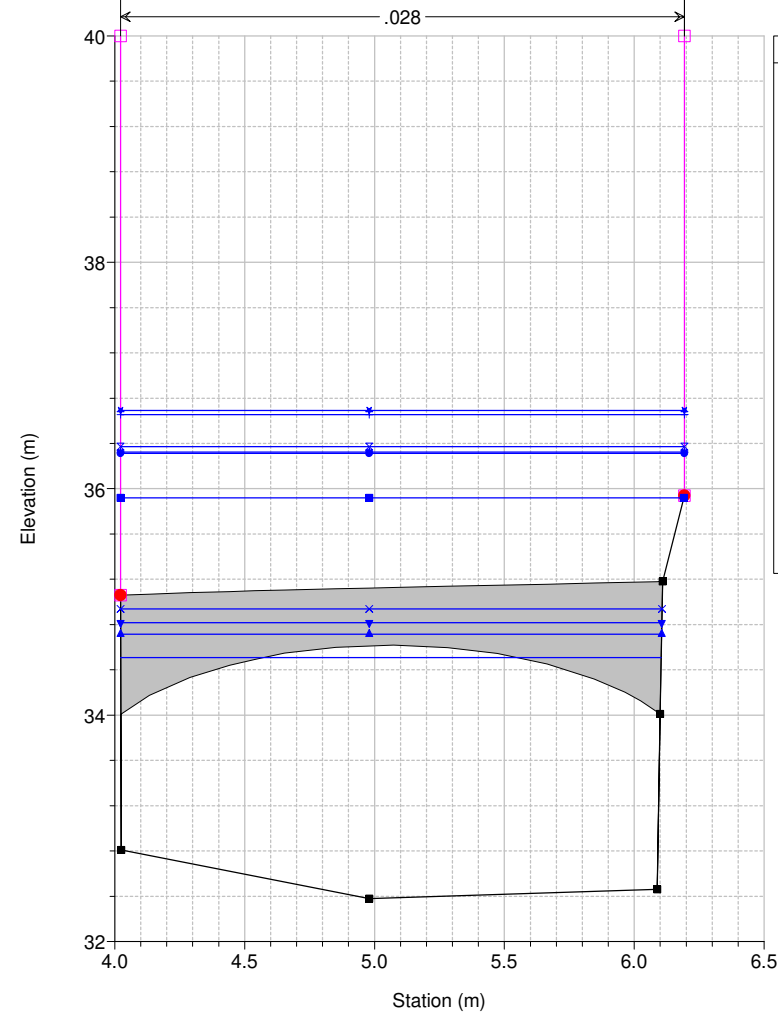

Legend

- WS Max WS - TR200_24_0
- WS Max WS - TR200_18_0
- WS Max WS - TR200_12_0
- WS Max WS - TR200_36_0
- WS Max WS - TR200_09_0
- WS Max WS - TR200_06_0
- WS Max WS - TR200_03_0
- WS Max WS - TR200_01_5
- WS Max WS - TR200_01_0
- WS Max WS - TR200_00_5
- Ground
- Levee
- Bank Sta

Studio Scandicci Torrenti Greve-Vingone
River = Fosso Stagno Reach = Stagno RS = 7.5 BR

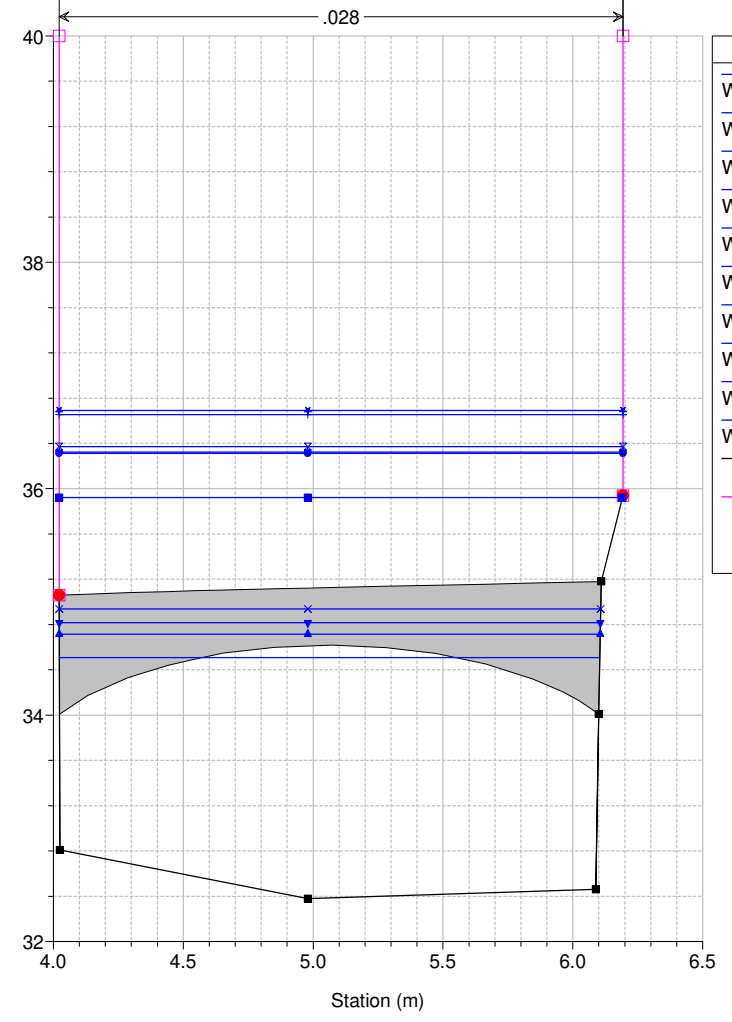

Legend

- WS Max WS - TR200_24_0
- WS Max WS - TR200_18_0
- WS Max WS - TR200_12_0
- WS Max WS - TR200_36_0
- WS Max WS - TR200_09_0
- WS Max WS - TR200_06_0
- WS Max WS - TR200_03_0
- WS Max WS - TR200_01_5
- WS Max WS - TR200_01_0
- WS Max WS - TR200_00_5
- Ground
- Levee
- Bank Sta

Studio Scandicci Torrenti Greve-Vingone
River = Fosso Stagno Reach = Stagno RS = 7 SG0049_C

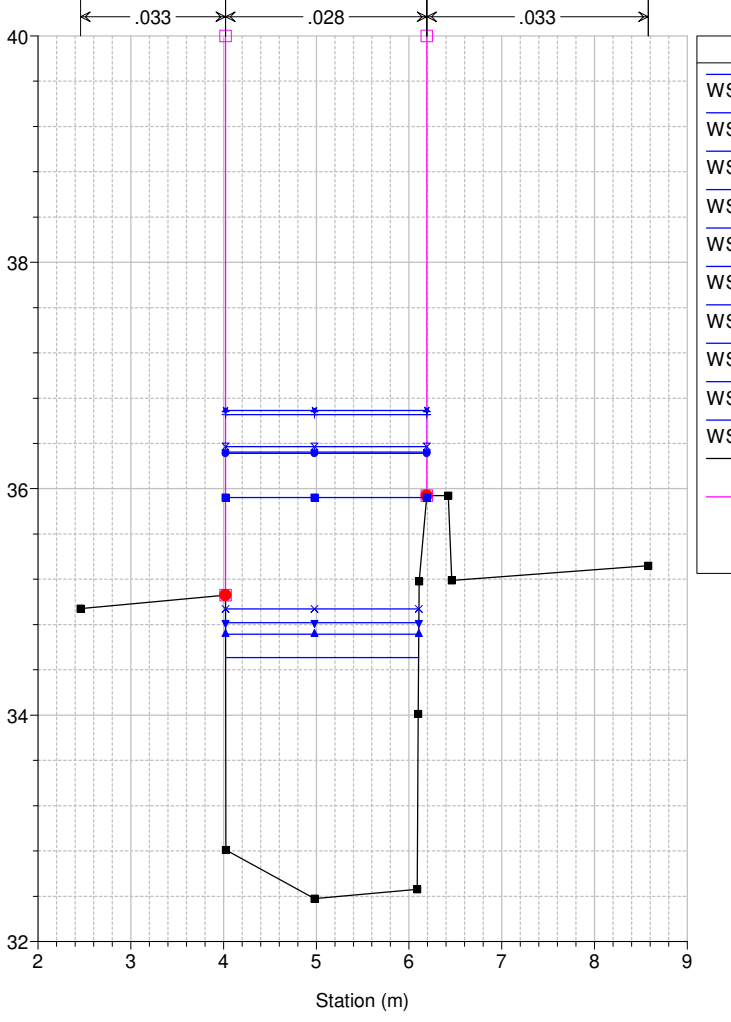

Legend

- WS Max WS - TR200_24_0
- WS Max WS - TR200_18_0
- WS Max WS - TR200_12_0
- WS Max WS - TR200_36_0
- WS Max WS - TR200_09_0
- WS Max WS - TR200_06_0
- WS Max WS - TR200_03_0
- WS Max WS - TR200_01_5
- WS Max WS - TR200_01_0
- WS Max WS - TR200_00_5
- Ground
- Levee
- Bank Sta

Studio Scandicci Torrenti Greve-Vingone
River = Fosso Stagno Reach = Stagno RS = 6 SG0049_D

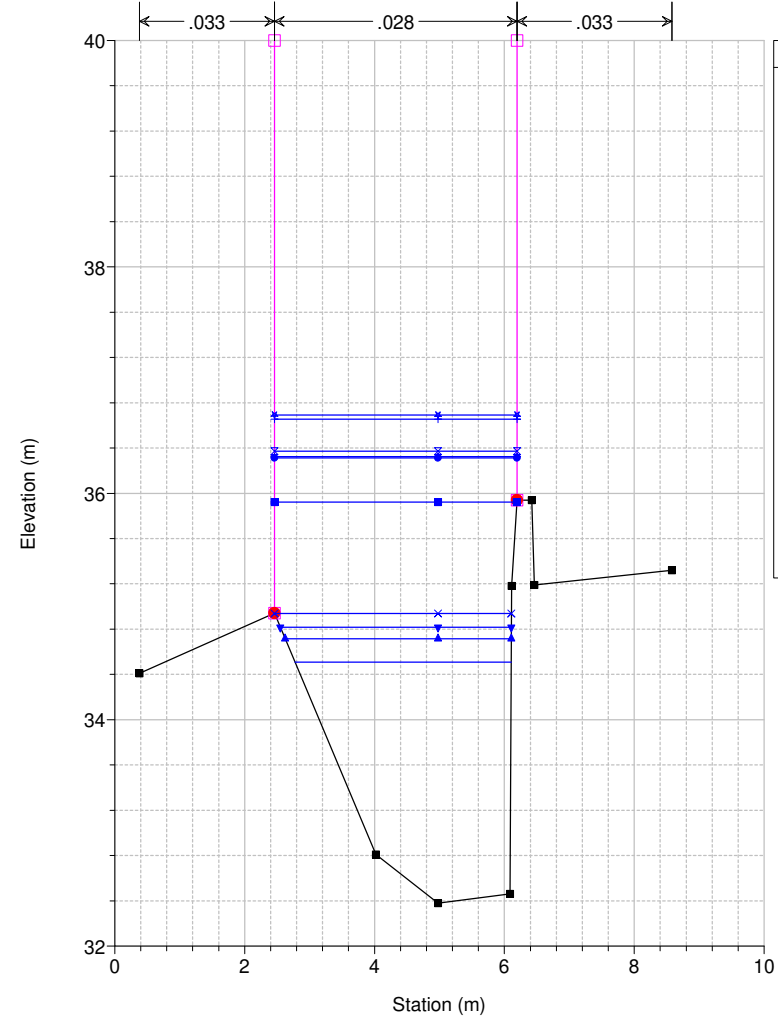

Legend	
WS Max WS - TR200_24_0	▲
WS Max WS - TR200_18_0	+
WS Max WS - TR200_12_0	×
WS Max WS - TR200_36_0	●
WS Max WS - TR200_09_0	●
WS Max WS - TR200_06_0	■
WS Max WS - TR200_03_0	×
WS Max WS - TR200_01_5	▼
WS Max WS - TR200_01_0	▲
WS Max WS - TR200_00_5	▲
Ground	■
Levee	□
Bank Sta	●

Studio Scandicci Torrenti Greve-Vingone
River = Fosso Stagno Reach = Stagno RS = 5 SG0050_

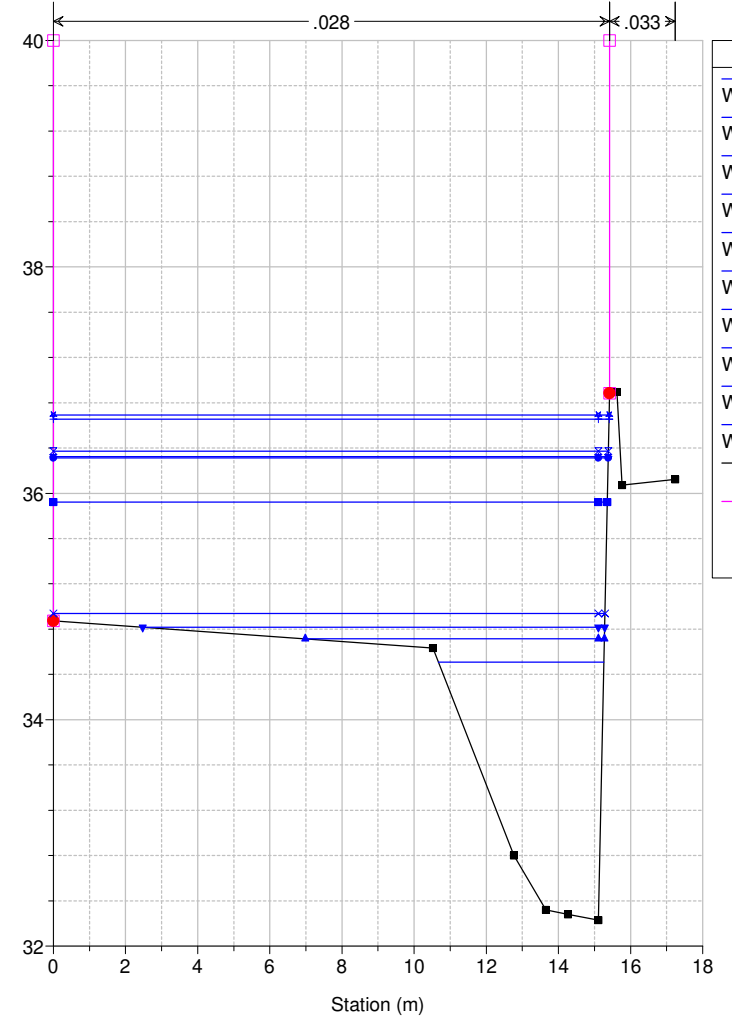

Legend	
WS Max WS - TR200_24_0	▲
WS Max WS - TR200_18_0	+
WS Max WS - TR200_12_0	×
WS Max WS - TR200_36_0	●
WS Max WS - TR200_09_0	●
WS Max WS - TR200_06_0	■
WS Max WS - TR200_03_0	×
WS Max WS - TR200_01_5	▼
WS Max WS - TR200_01_0	▲
WS Max WS - TR200_00_5	▲
Ground	■
Levee	□
Bank Sta	●

Studio Scandicci Torrenti Greve-Vingone
River = Fosso Stagno Reach = Stagno RS = 4 SG0051_

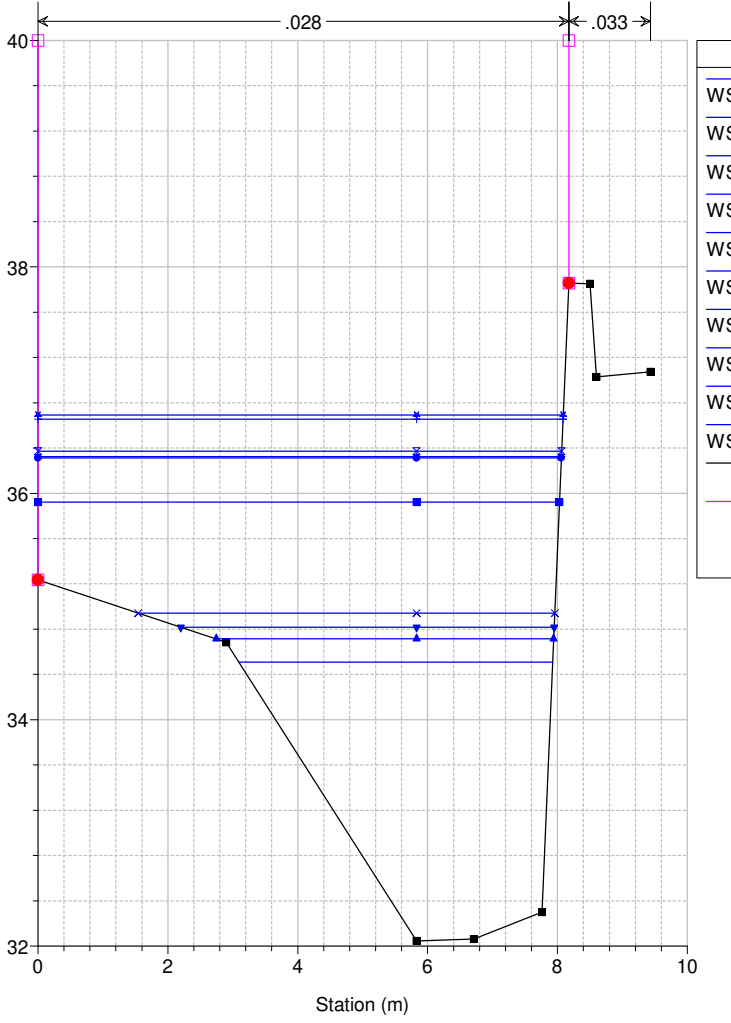

Legend	
WS Max WS - TR200_24_0	▲
WS Max WS - TR200_18_0	+
WS Max WS - TR200_12_0	×
WS Max WS - TR200_36_0	●
WS Max WS - TR200_09_0	●
WS Max WS - TR200_06_0	■
WS Max WS - TR200_03_0	×
WS Max WS - TR200_01_5	▼
WS Max WS - TR200_01_0	▲
WS Max WS - TR200_00_5	▲
Ground	■
Levee	□
Bank Sta	●

Studio Scandicci Torrenti Greve-Vingone
River = Fosso Stagno Reach = Stagno RS = 3 SG0052_A

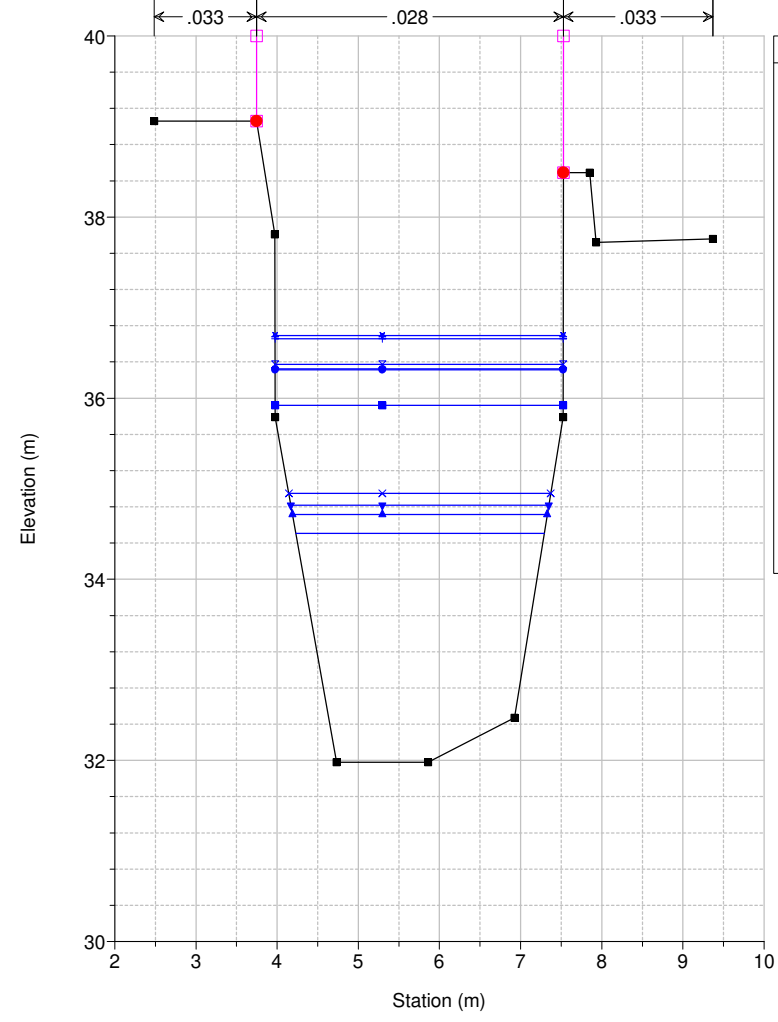

Legend	
WS Max WS - TR200_24_0	▲
WS Max WS - TR200_18_0	+
WS Max WS - TR200_12_0	×
WS Max WS - TR200_36_0	●
WS Max WS - TR200_09_0	●
WS Max WS - TR200_06_0	■
WS Max WS - TR200_03_0	×
WS Max WS - TR200_01_5	▼
WS Max WS - TR200_01_0	▲
WS Max WS - TR200_00_5	▲
Ground	■
Levee	□
Bank Sta	●

Studio Scandicci Torrenti Greve-Vingone
River = Fosso Stagno Reach = Stagno RS = 2 SG0052_B

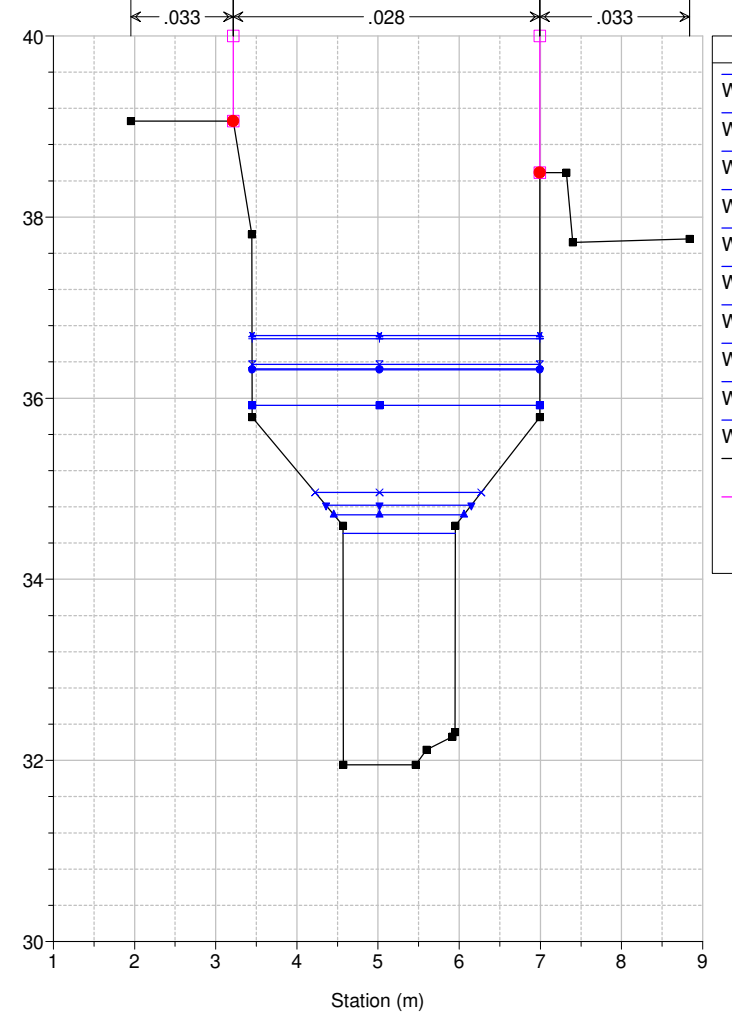

Legend	
WS Max WS - TR200_24_0	▲
WS Max WS - TR200_18_0	+
WS Max WS - TR200_12_0	×
WS Max WS - TR200_36_0	●
WS Max WS - TR200_09_0	●
WS Max WS - TR200_06_0	■
WS Max WS - TR200_03_0	×
WS Max WS - TR200_01_5	▼
WS Max WS - TR200_01_0	▲
WS Max WS - TR200_00_5	▲
Ground	■
Levee	□
Bank Sta	●

Studio Scandicci Torrenti Greve-Vingone
River = Fosso Stagno Reach = Stagno RS = 1.5 IS

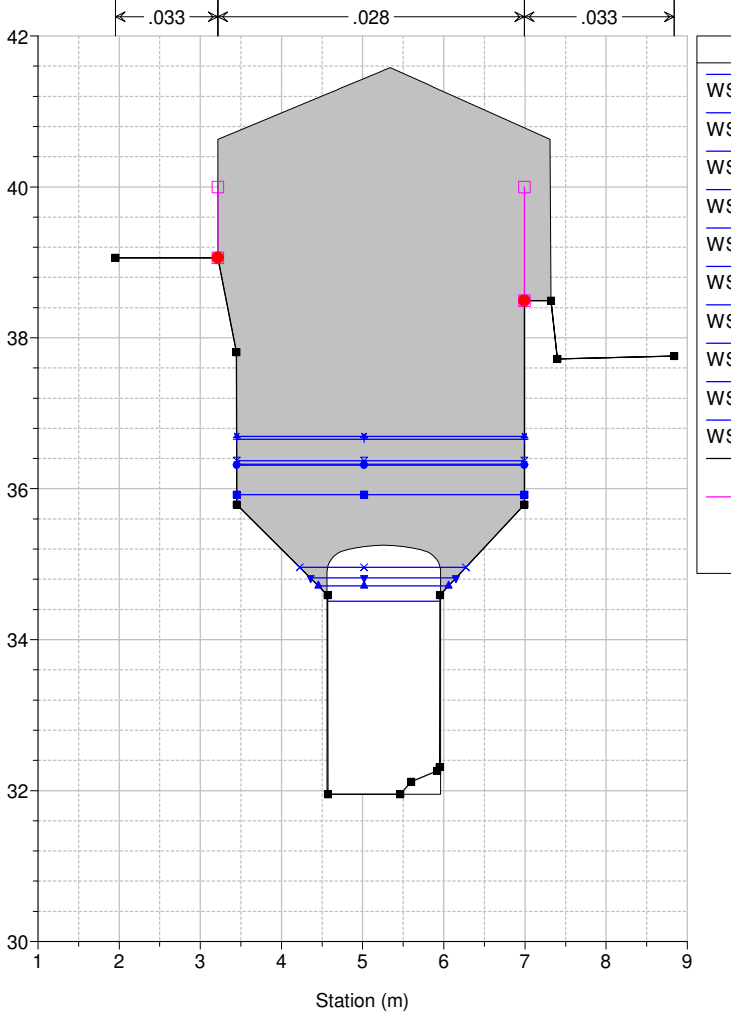

Legend	
WS Max WS - TR200_24_0	▲
WS Max WS - TR200_18_0	+
WS Max WS - TR200_12_0	×
WS Max WS - TR200_36_0	●
WS Max WS - TR200_09_0	●
WS Max WS - TR200_06_0	■
WS Max WS - TR200_03_0	×
WS Max WS - TR200_01_5	▼
WS Max WS - TR200_01_0	▲
WS Max WS - TR200_00_5	▲
Ground	■
Levee	□
Bank Sta	●

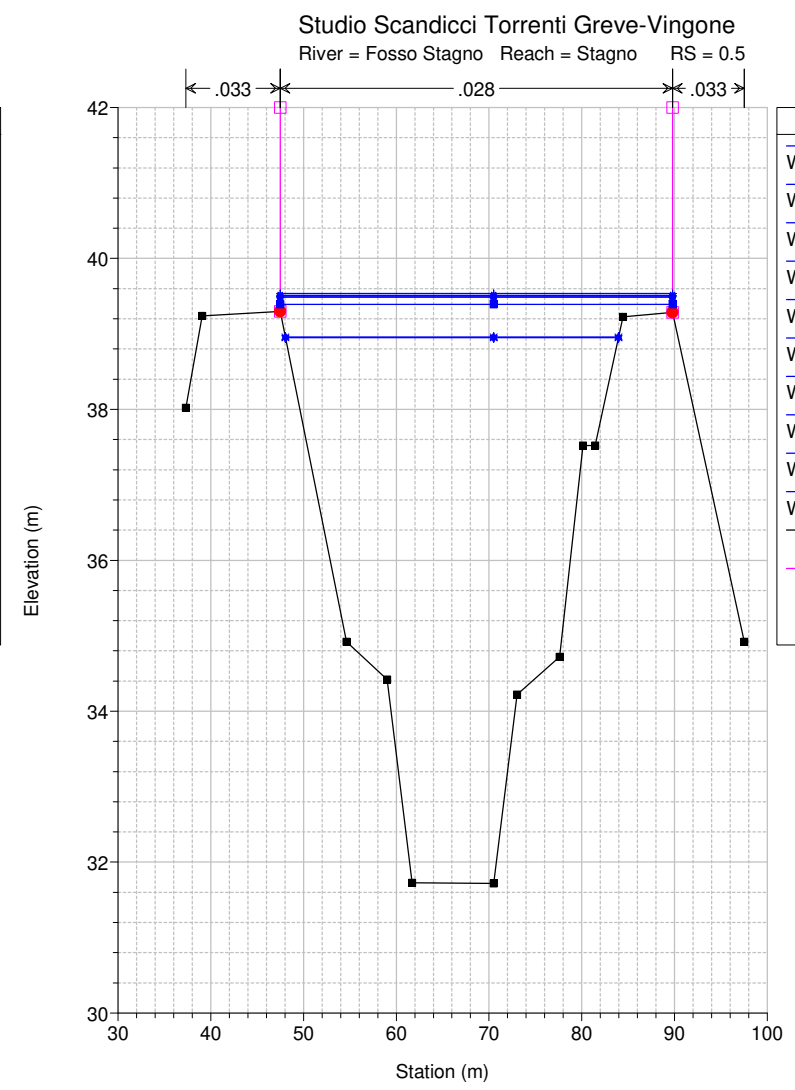
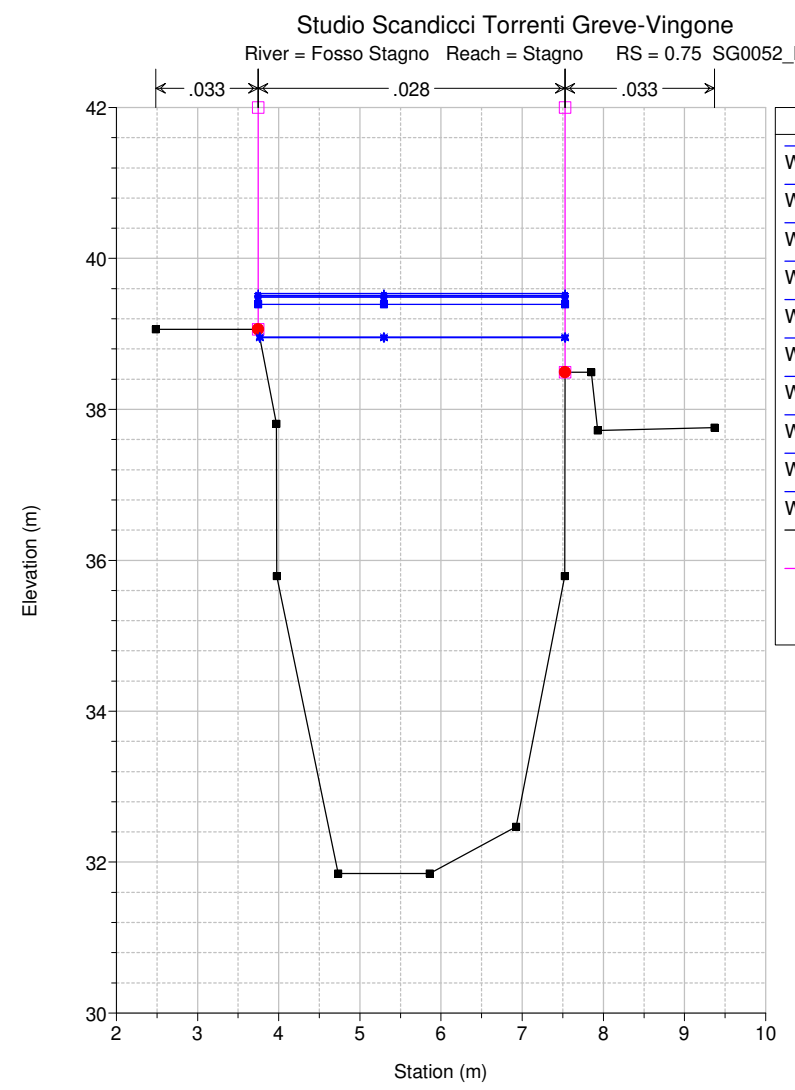
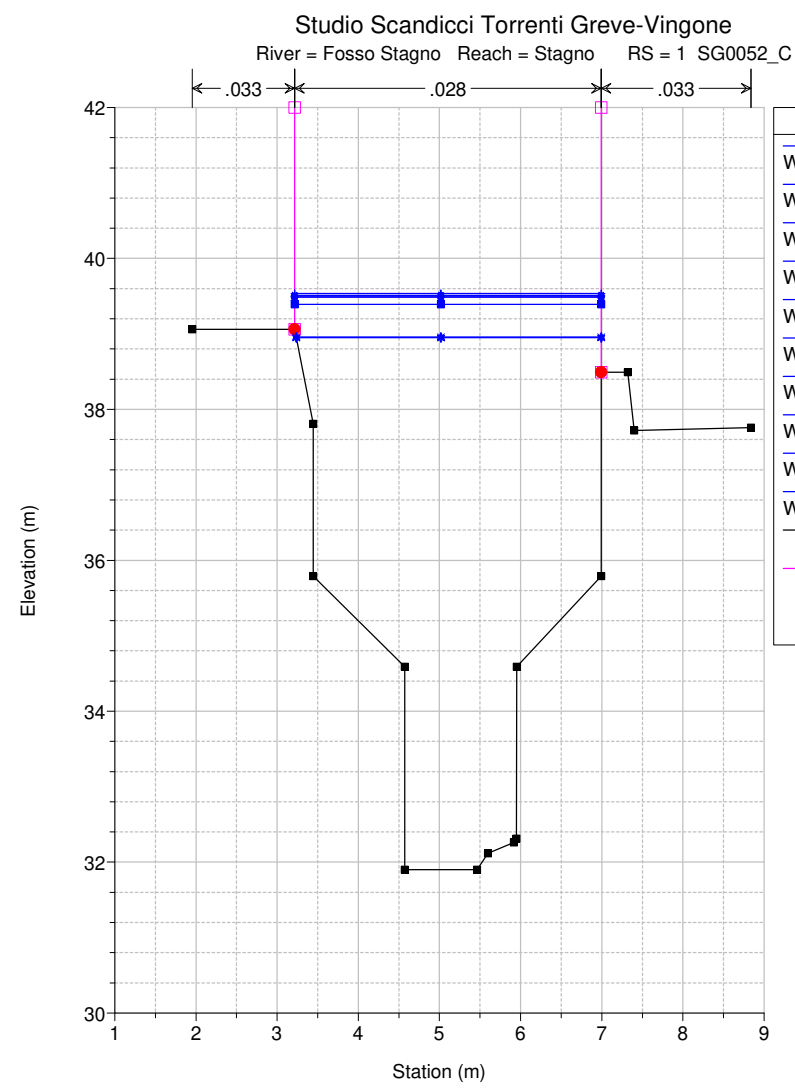

Studio Scandicci Torrenti Greve-Vingone
River = Fosso Stagnolo Reach = Stagnolo RS = 107 ST0001_D

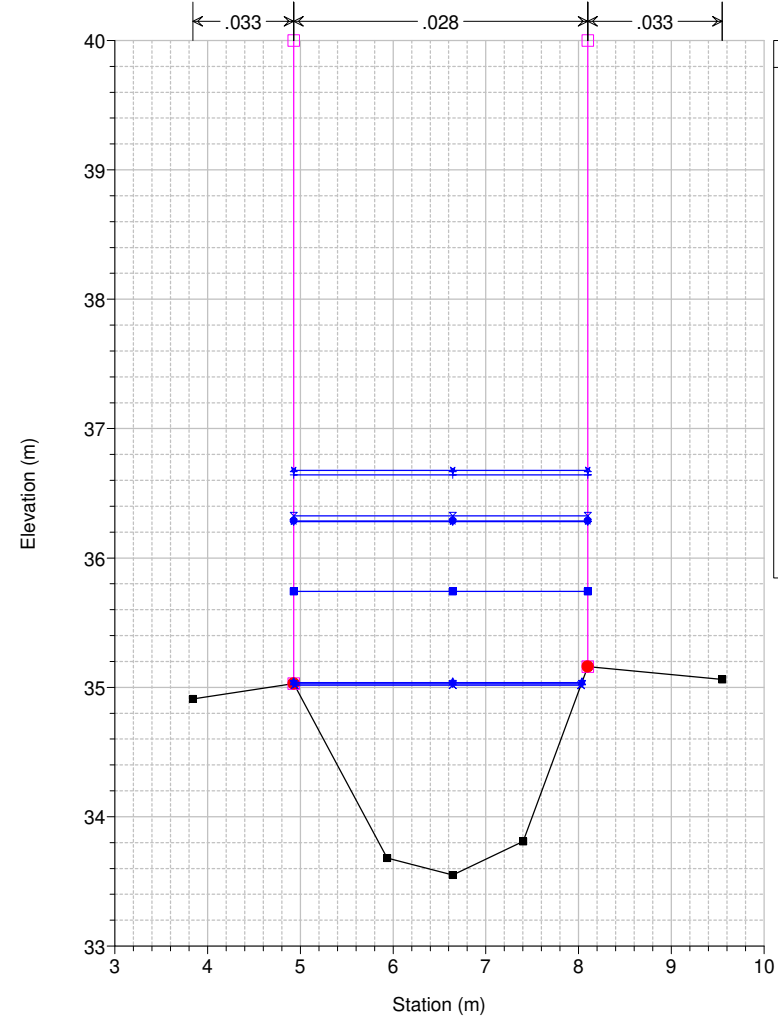

Legend	
WS Max WS - TR200_24_0	▲
WS Max WS - TR200_18_0	▲
WS Max WS - TR200_12_0	▲
WS Max WS - TR200_09_0	▲
WS Max WS - TR200_36_0	▲
WS Max WS - TR200_06_0	▲
WS Max WS - TR200_01_5	▲
WS Max WS - TR200_01_0	▲
WS Max WS - TR200_00_5	▲
WS Max WS - TR200_03_0	▲
Ground	■
Levee	□
Bank Sta	●

Studio Scandicci Torrenti Greve-Vingone
River = Fosso Stagnolo Reach = Stagnolo RS = 106 ST0002_

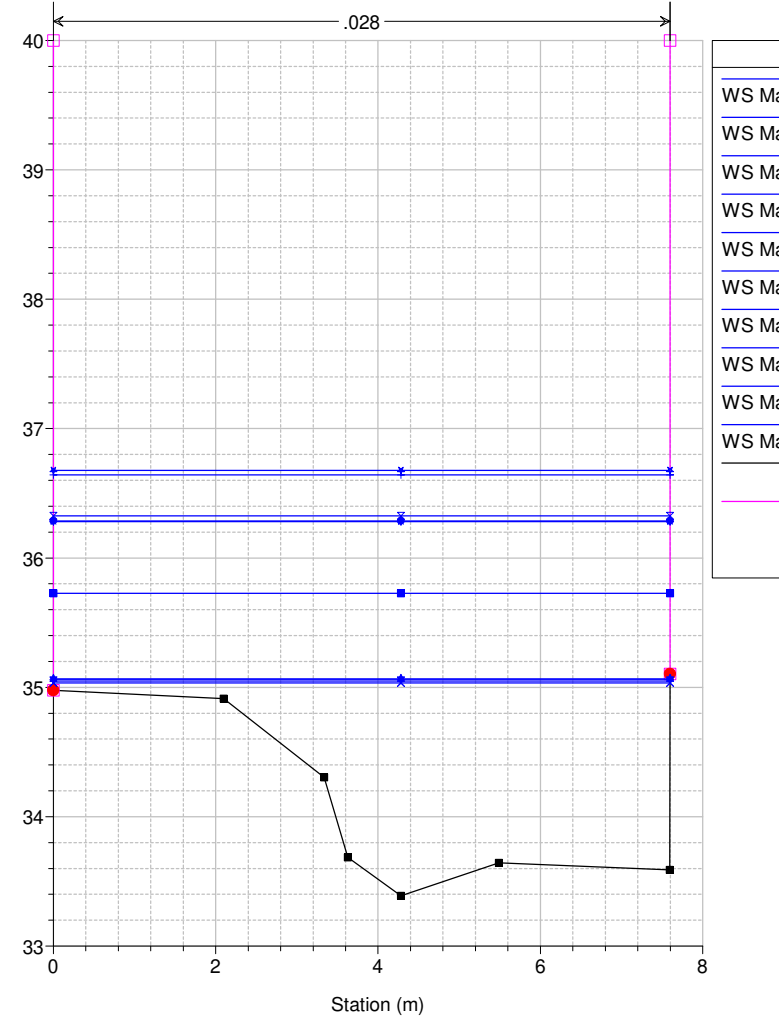

Legend	
WS Max WS - TR200_24_0	▲
WS Max WS - TR200_18_0	▲
WS Max WS - TR200_12_0	▲
WS Max WS - TR200_09_0	▲
WS Max WS - TR200_36_0	▲
WS Max WS - TR200_06_0	▲
WS Max WS - TR200_01_0	▲
WS Max WS - TR200_01_5	▲
WS Max WS - TR200_00_5	▲
WS Max WS - TR200_03_0	▲
Ground	■
Levee	□
Bank Sta	●

Studio Scandicci Torrenti Greve-Vingone
River = Fosso Stagnolo Reach = Stagnolo RS = 105 ST0003_

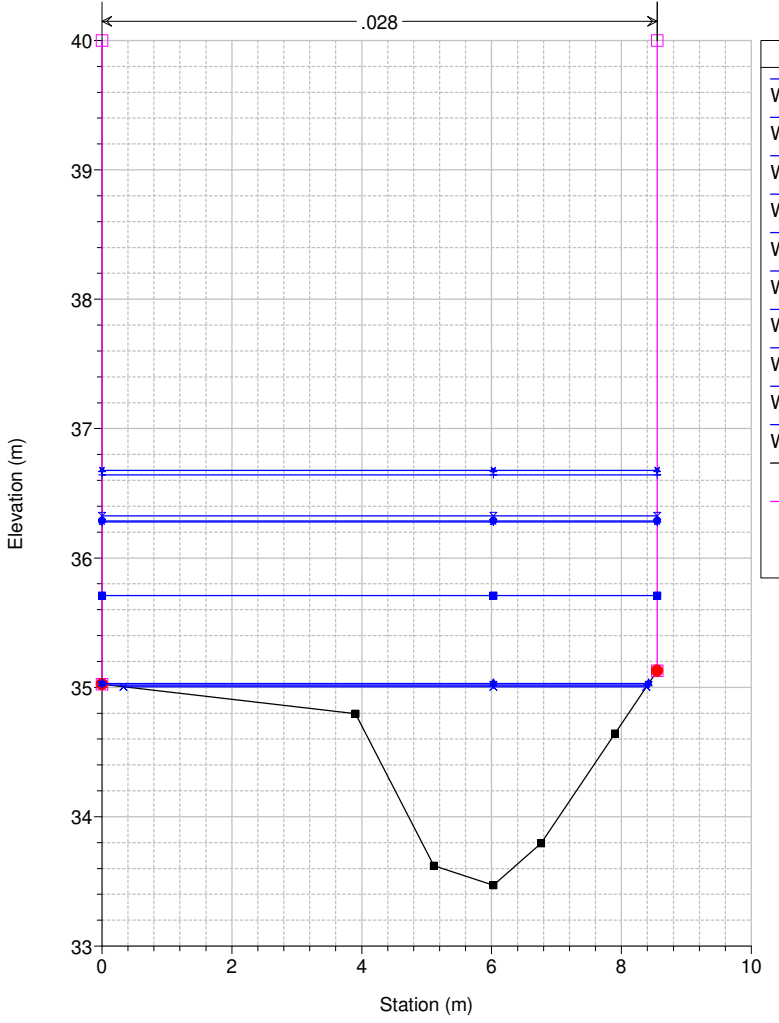

Legend	
WS Max WS - TR200_24_0	▲
WS Max WS - TR200_18_0	▲
WS Max WS - TR200_12_0	▲
WS Max WS - TR200_09_0	▲
WS Max WS - TR200_36_0	▲
WS Max WS - TR200_06_0	▲
WS Max WS - TR200_01_5	▲
WS Max WS - TR200_01_0	▲
WS Max WS - TR200_00_5	▲
WS Max WS - TR200_03_0	▲
Ground	■
Levee	□
Bank Sta	●

Studio Scandicci Torrenti Greve-Vingone
River = Fosso Stagnolo Reach = Stagnolo RS = 104 ST0004_A

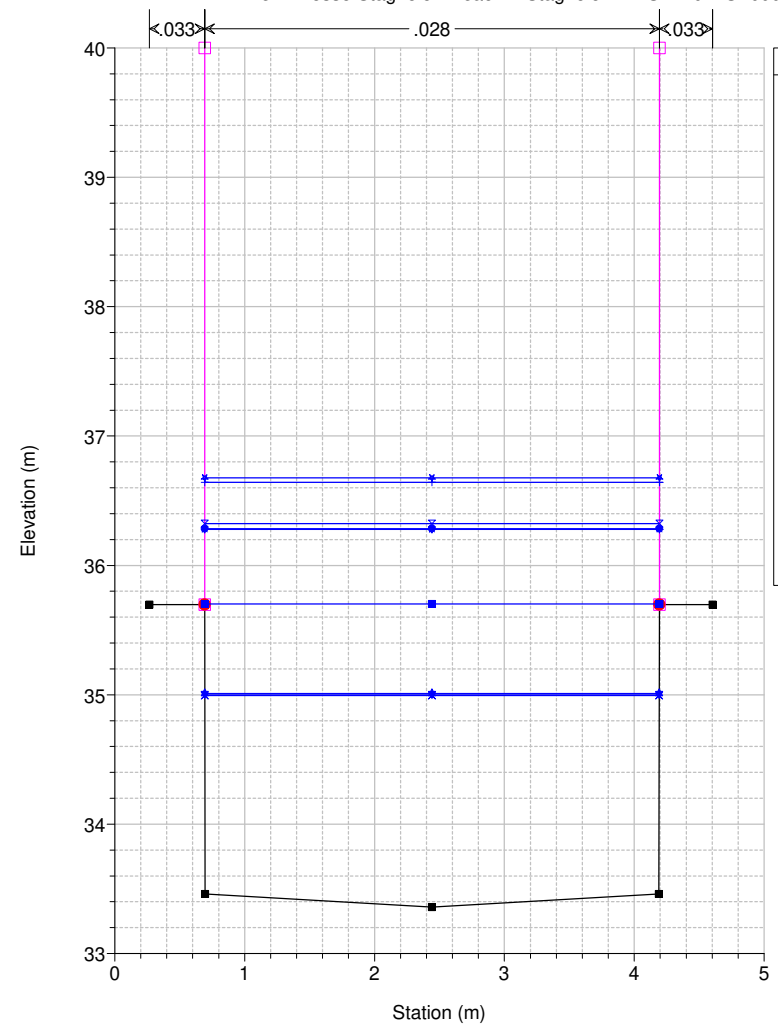

Legend	
WS Max WS - TR200_24_0	▲
WS Max WS - TR200_18_0	▲
WS Max WS - TR200_12_0	▲
WS Max WS - TR200_09_0	▲
WS Max WS - TR200_36_0	▲
WS Max WS - TR200_06_0	▲
WS Max WS - TR200_01_5	▲
WS Max WS - TR200_01_0	▲
WS Max WS - TR200_00_5	▲
WS Max WS - TR200_03_0	▲
Ground	■
Levee	□
Bank Sta	●

Studio Scandicci Torrenti Greve-Vingone
River = Fosso Stagnolo Reach = Stagnolo RS = 103 ST0004_B

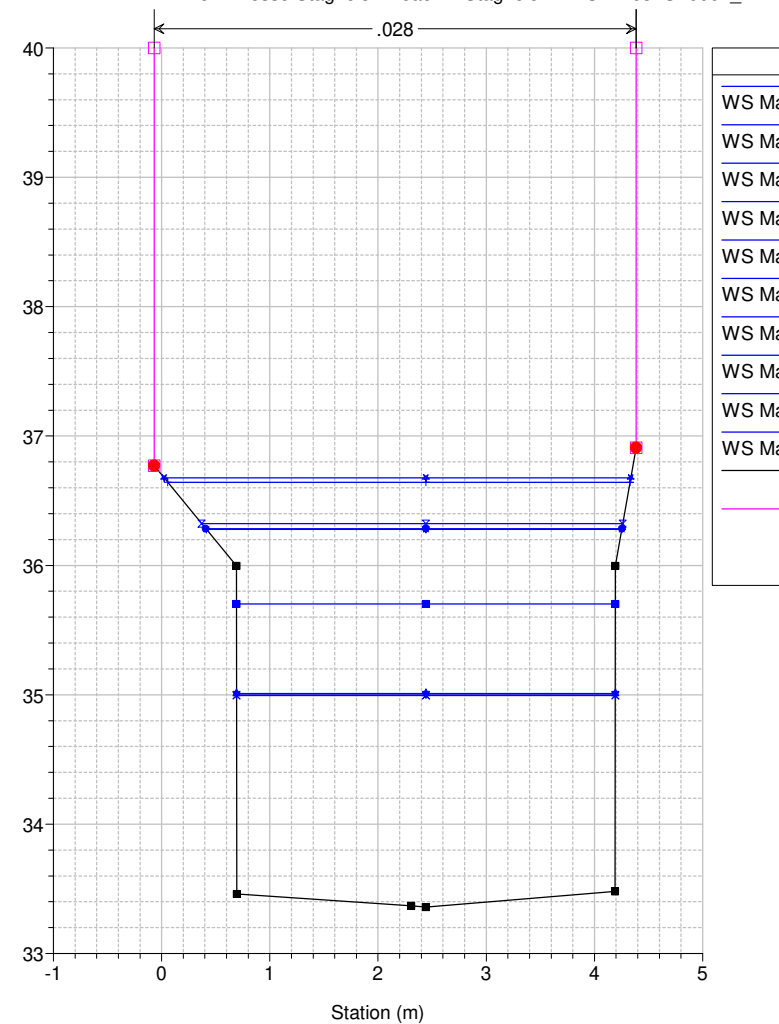

Legend	
WS Max WS - TR200_24_0	▲
WS Max WS - TR200_18_0	▲
WS Max WS - TR200_12_0	▲
WS Max WS - TR200_09_0	▲
WS Max WS - TR200_36_0	▲
WS Max WS - TR200_06_0	▲
WS Max WS - TR200_01_5	▲
WS Max WS - TR200_01_0	▲
WS Max WS - TR200_00_5	▲
WS Max WS - TR200_03_0	▲
Ground	■
Levee	□
Bank Sta	●

Studio Scandicci Torrenti Greve-Vingone
River = Fosso Stagnolo Reach = Stagnolo RS = 102.5 BR

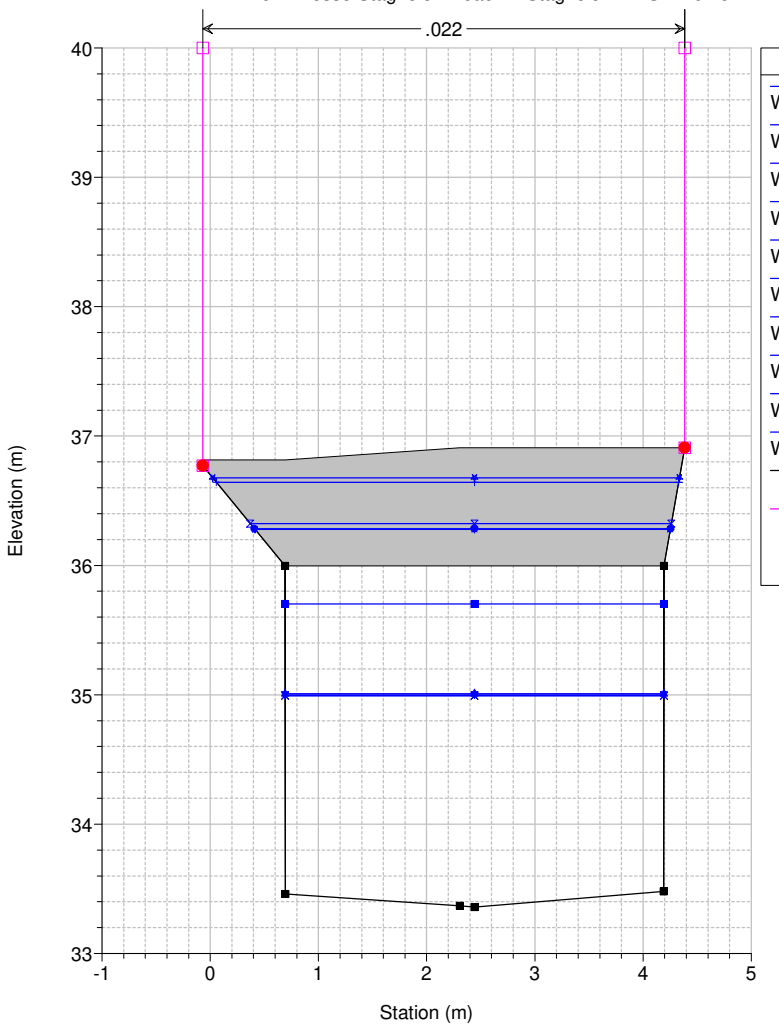

Legend	
WS Max WS - TR200_24_0	▲
WS Max WS - TR200_18_0	▲
WS Max WS - TR200_12_0	▲
WS Max WS - TR200_09_0	▲
WS Max WS - TR200_36_0	▲
WS Max WS - TR200_06_0	▲
WS Max WS - TR200_01_5	▲
WS Max WS - TR200_01_0	▲
WS Max WS - TR200_00_5	▲
WS Max WS - TR200_03_0	▲
Ground	■
Levee	□
Bank Sta	●

Studio Scandicci Torrenti Greve-Vingone
River = Fosso Stagnolo Reach = Stagnolo RS = 102.5 BR

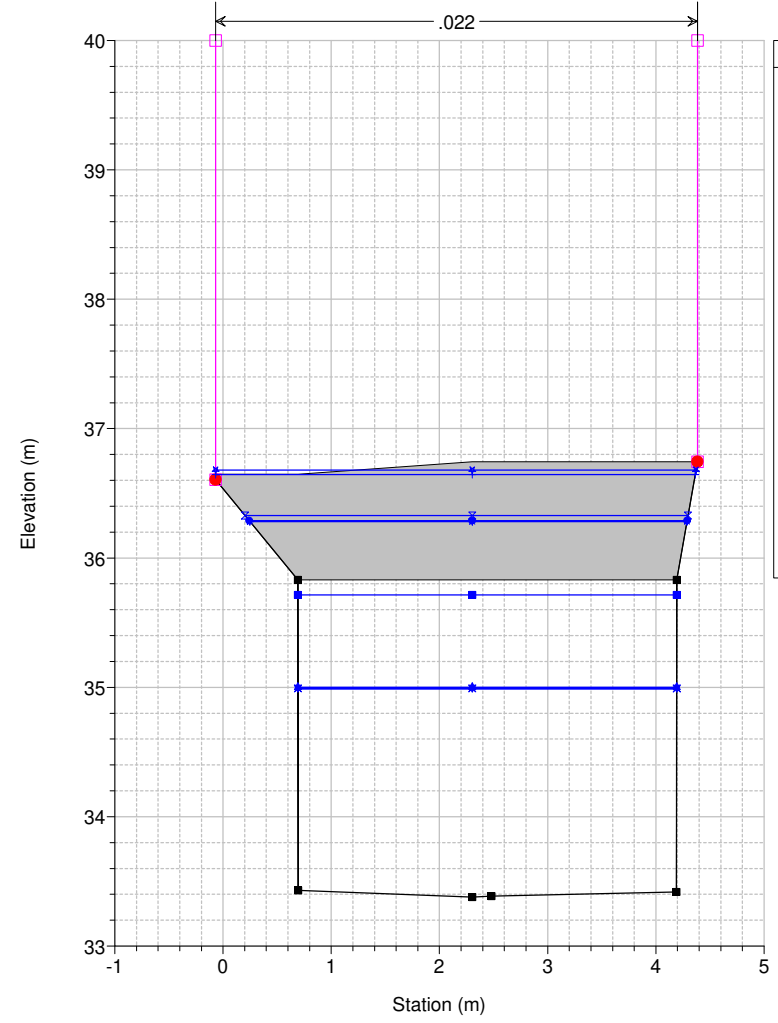

Legend	
WS Max WS - TR200_24_0	▲
WS Max WS - TR200_18_0	+
WS Max WS - TR200_12_0	×
WS Max WS - TR200_09_0	●
WS Max WS - TR200_36_0	■
WS Max WS - TR200_06_0	▼
WS Max WS - TR200_01_5	◆
WS Max WS - TR200_01_0	▲
WS Max WS - TR200_03_0	×
WS Max WS - TR200_00_5	●
Ground	■
Levee	□
Bank Sta	●

Studio Scandicci Torrenti Greve-Vingone
River = Fosso Stagnolo Reach = Stagnolo RS = 102 ST0004_C

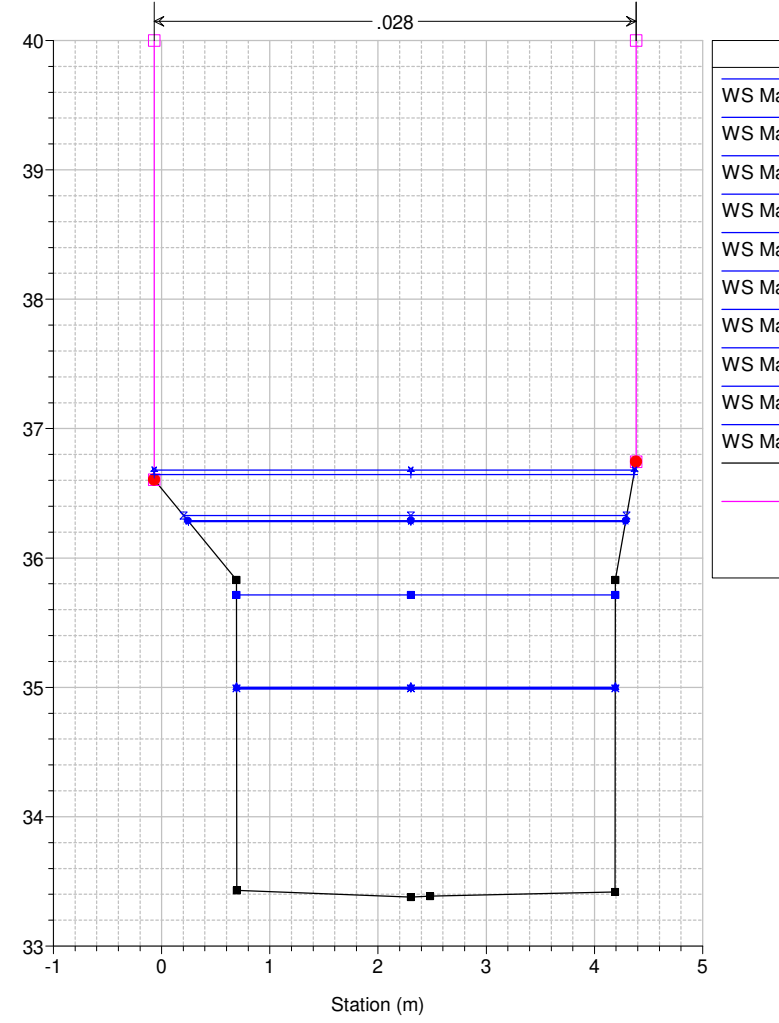

Legend	
WS Max WS - TR200_24_0	▲
WS Max WS - TR200_18_0	+
WS Max WS - TR200_12_0	×
WS Max WS - TR200_09_0	●
WS Max WS - TR200_36_0	■
WS Max WS - TR200_06_0	▼
WS Max WS - TR200_01_5	◆
WS Max WS - TR200_01_0	▲
WS Max WS - TR200_03_0	×
WS Max WS - TR200_00_5	●
Ground	■
Levee	□
Bank Sta	●

Studio Scandicci Torrenti Greve-Vingone
River = Fosso Stagnolo Reach = Stagnolo RS = 101 ST0004_D

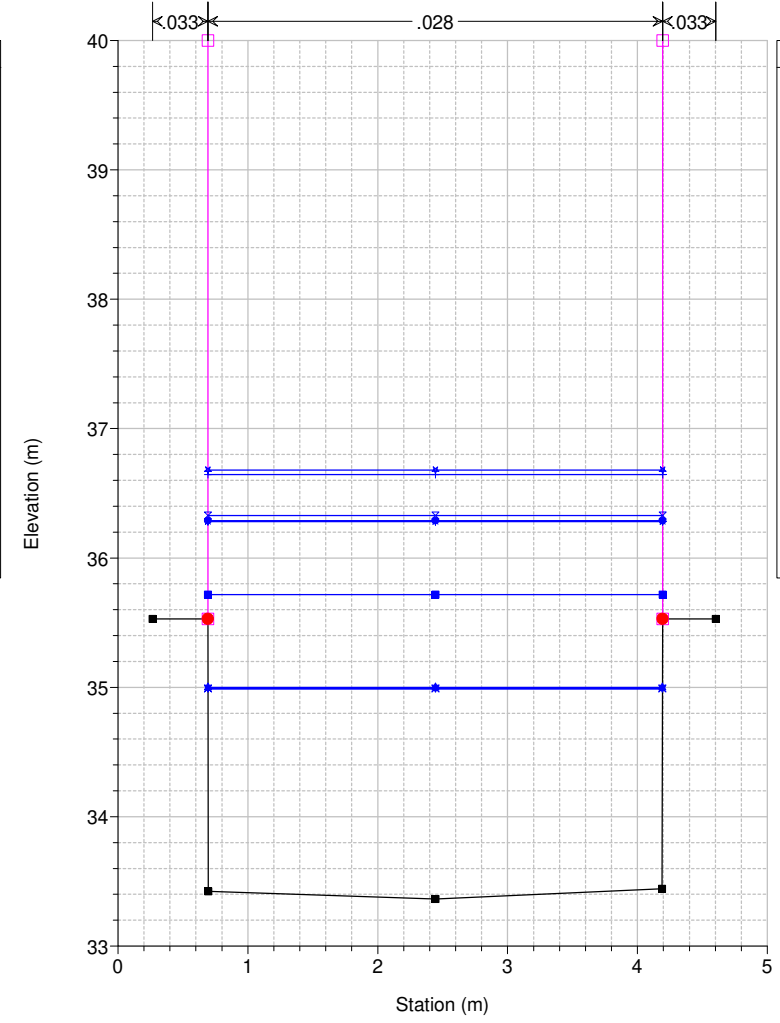

Legend	
WS Max WS - TR200_24_0	▲
WS Max WS - TR200_18_0	+
WS Max WS - TR200_12_0	×
WS Max WS - TR200_09_0	●
WS Max WS - TR200_36_0	■
WS Max WS - TR200_06_0	▼
WS Max WS - TR200_01_5	◆
WS Max WS - TR200_01_0	▲
WS Max WS - TR200_03_0	×
WS Max WS - TR200_00_5	●
Ground	■
Levee	□
Bank Sta	●

Studio Scandicci Torrenti Greve-Vingone
River = Fosso Stagnolo Reach = Stagnolo RS = 100 ST0005_A

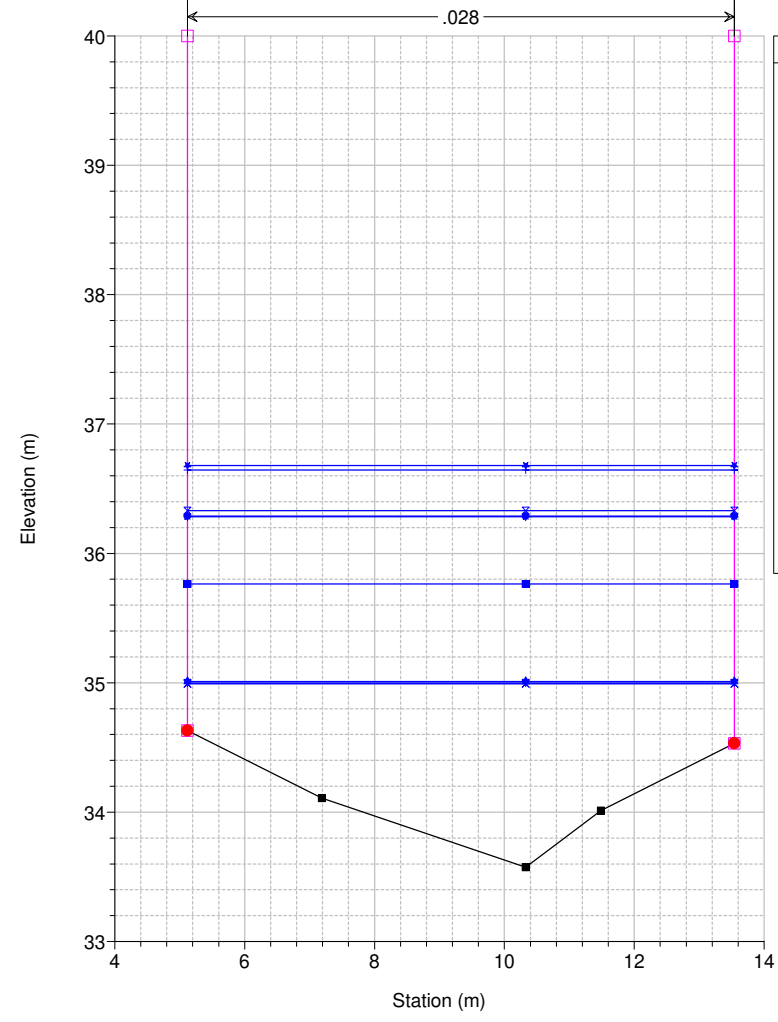

Legend	
WS Max WS - TR200_24_0	▲
WS Max WS - TR200_18_0	+
WS Max WS - TR200_12_0	×
WS Max WS - TR200_09_0	●
WS Max WS - TR200_36_0	■
WS Max WS - TR200_06_0	▼
WS Max WS - TR200_01_5	◆
WS Max WS - TR200_01_0	▲
WS Max WS - TR200_03_0	×
WS Max WS - TR200_00_5	●
Ground	■
Levee	□
Bank Sta	●

Studio Scandicci Torrenti Greve-Vingone
River = Fosso Stagnolo Reach = Stagnolo RS = 99 ST0005_B

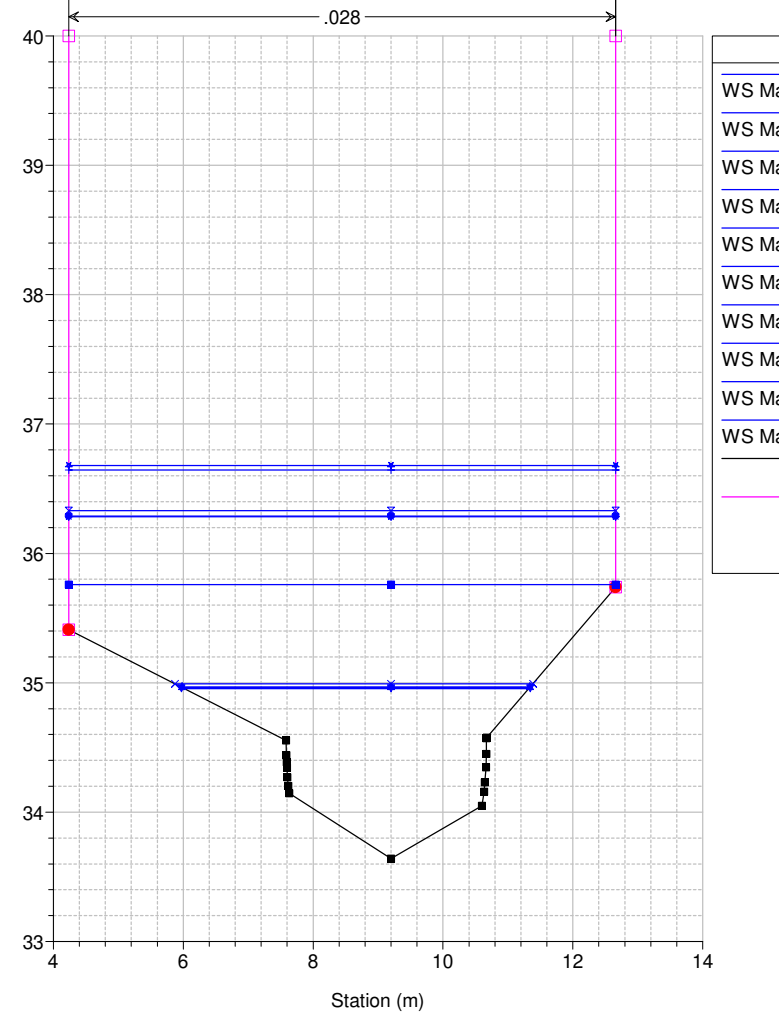

Legend	
WS Max WS - TR200_24_0	▲
WS Max WS - TR200_18_0	+
WS Max WS - TR200_12_0	×
WS Max WS - TR200_09_0	●
WS Max WS - TR200_36_0	■
WS Max WS - TR200_06_0	▼
WS Max WS - TR200_03_0	×
WS Max WS - TR200_01_5	◆
WS Max WS - TR200_01_0	▲
WS Max WS - TR200_00_5	●
Ground	■
Levee	□
Bank Sta	●

Studio Scandicci Torrenti Greve-Vingone
River = Fosso Stagnolo Reach = Stagnolo RS = 98.5 BR

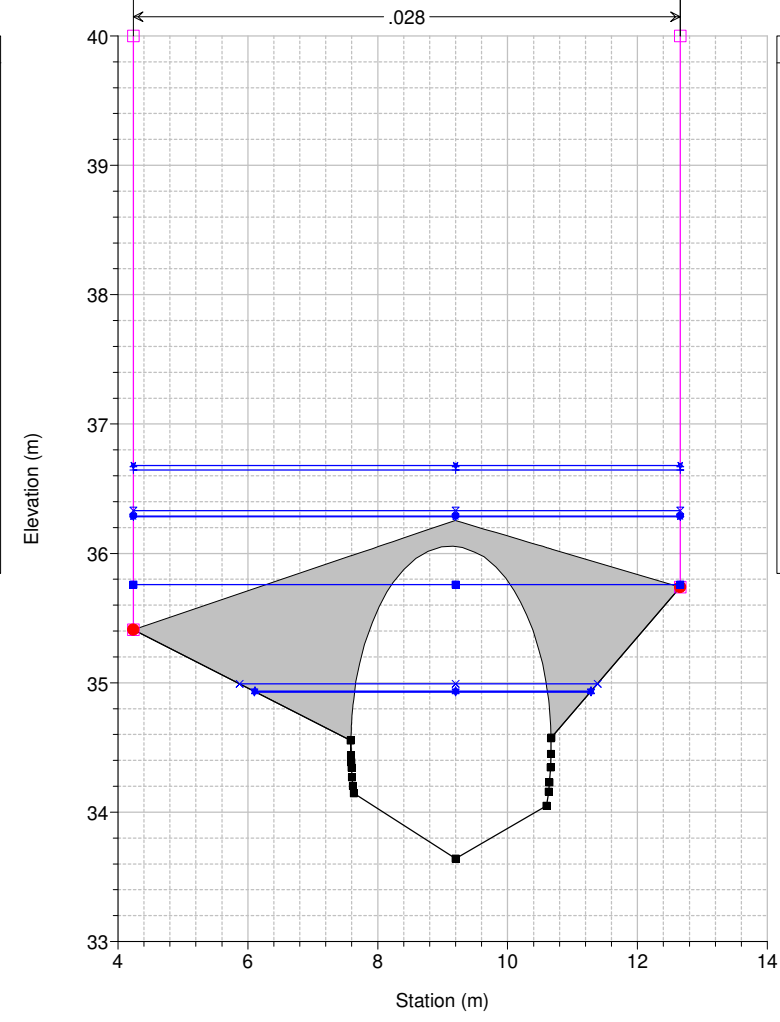

Legend	
WS Max WS - TR200_24_0	▲
WS Max WS - TR200_18_0	+
WS Max WS - TR200_12_0	×
WS Max WS - TR200_09_0	●
WS Max WS - TR200_36_0	■
WS Max WS - TR200_06_0	▼
WS Max WS - TR200_03_0	×
WS Max WS - TR200_01_5	◆
WS Max WS - TR200_01_0	▲
WS Max WS - TR200_00_5	●
Ground	■
Levee	□
Bank Sta	●

Studio Scandicci Torrenti Greve-Vingone
River = Fosso Stagnolo Reach = Stagnolo RS = 98.5 BR

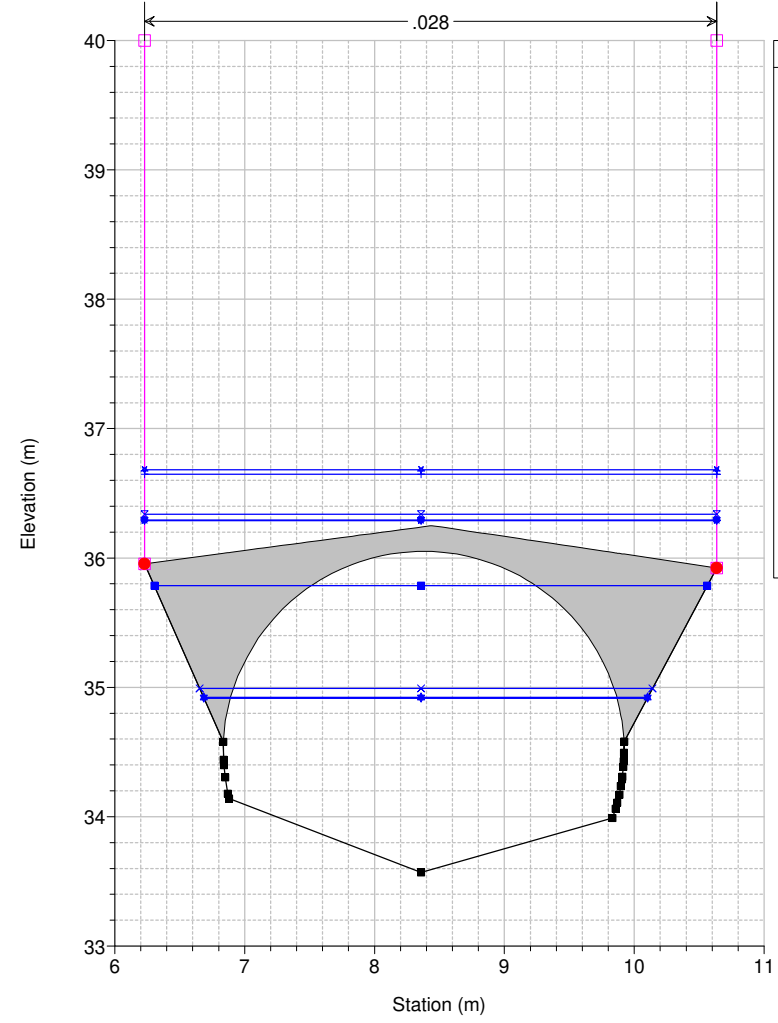

Legend	
WS Max WS - TR200_24_0	▲
WS Max WS - TR200_18_0	+
WS Max WS - TR200_12_0	×
WS Max WS - TR200_09_0	●
WS Max WS - TR200_36_0	■
WS Max WS - TR200_06_0	■
WS Max WS - TR200_03_0	×
WS Max WS - TR200_01_5	▼
WS Max WS - TR200_01_0	▲
WS Max WS - TR200_00_5	▲
Ground	■
Levee	□
Bank Sta	●

Studio Scandicci Torrenti Greve-Vingone
River = Fosso Stagnolo Reach = Stagnolo RS = 98 ST0005_C

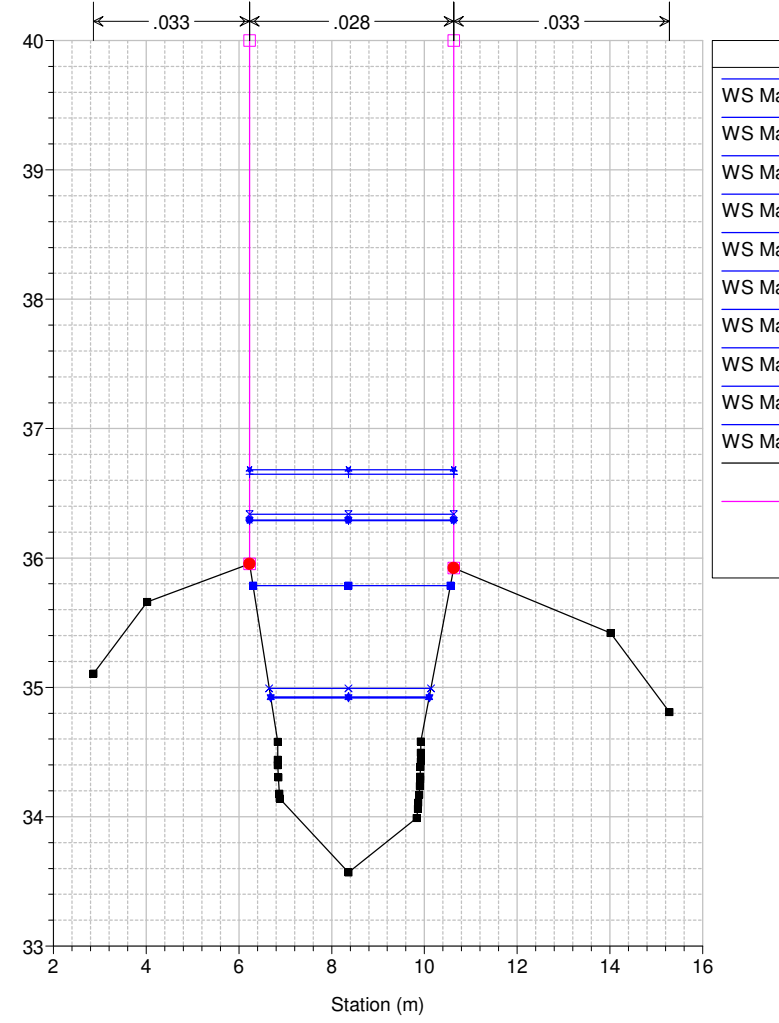

Legend	
WS Max WS - TR200_24_0	▲
WS Max WS - TR200_18_0	+
WS Max WS - TR200_12_0	×
WS Max WS - TR200_09_0	●
WS Max WS - TR200_36_0	■
WS Max WS - TR200_06_0	■
WS Max WS - TR200_03_0	×
WS Max WS - TR200_01_5	▼
WS Max WS - TR200_01_0	▲
WS Max WS - TR200_00_5	▲
Ground	■
Levee	□
Bank Sta	●

Studio Scandicci Torrenti Greve-Vingone
River = Fosso Stagnolo Reach = Stagnolo RS = 97 ST0005_D

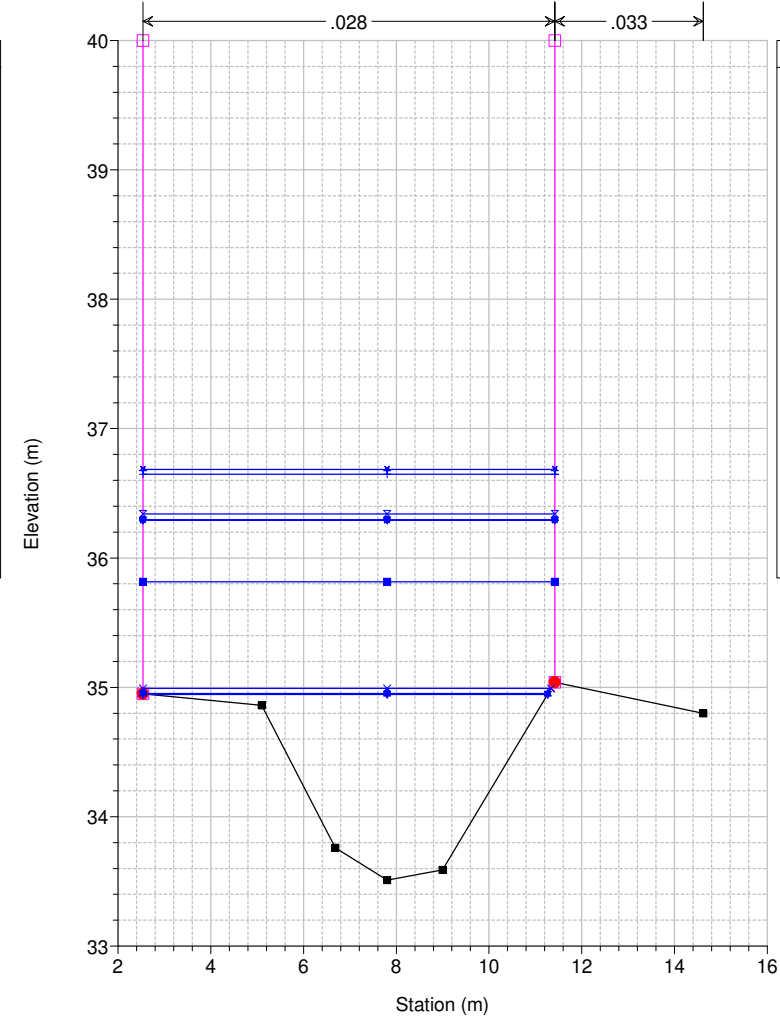

Legend	
WS Max WS - TR200_24_0	▲
WS Max WS - TR200_18_0	+
WS Max WS - TR200_12_0	×
WS Max WS - TR200_09_0	●
WS Max WS - TR200_36_0	■
WS Max WS - TR200_06_0	■
WS Max WS - TR200_03_0	×
WS Max WS - TR200_01_5	▼
WS Max WS - TR200_01_0	▲
WS Max WS - TR200_00_5	▲
Ground	■
Levee	□
Bank Sta	●

Studio Scandicci Torrenti Greve-Vingone
River = Fosso Stagnolo Reach = Stagnolo RS = 96 ST0006_

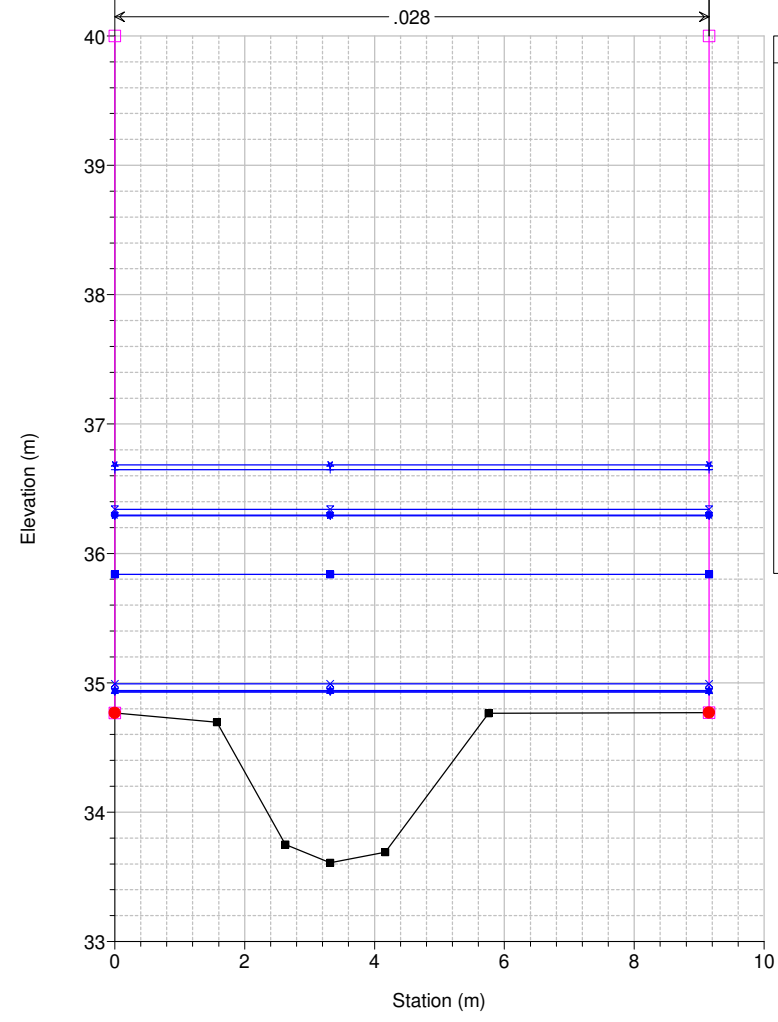

Legend	
WS Max WS - TR200_24_0	▲
WS Max WS - TR200_18_0	+
WS Max WS - TR200_12_0	×
WS Max WS - TR200_09_0	●
WS Max WS - TR200_36_0	■
WS Max WS - TR200_06_0	■
WS Max WS - TR200_03_0	×
WS Max WS - TR200_01_5	▼
WS Max WS - TR200_01_0	▲
WS Max WS - TR200_00_5	▲
Ground	■
Levee	□
Bank Sta	●

Studio Scandicci Torrenti Greve-Vingone
River = Fosso Stagnolo Reach = Stagnolo RS = 95 ST0007_

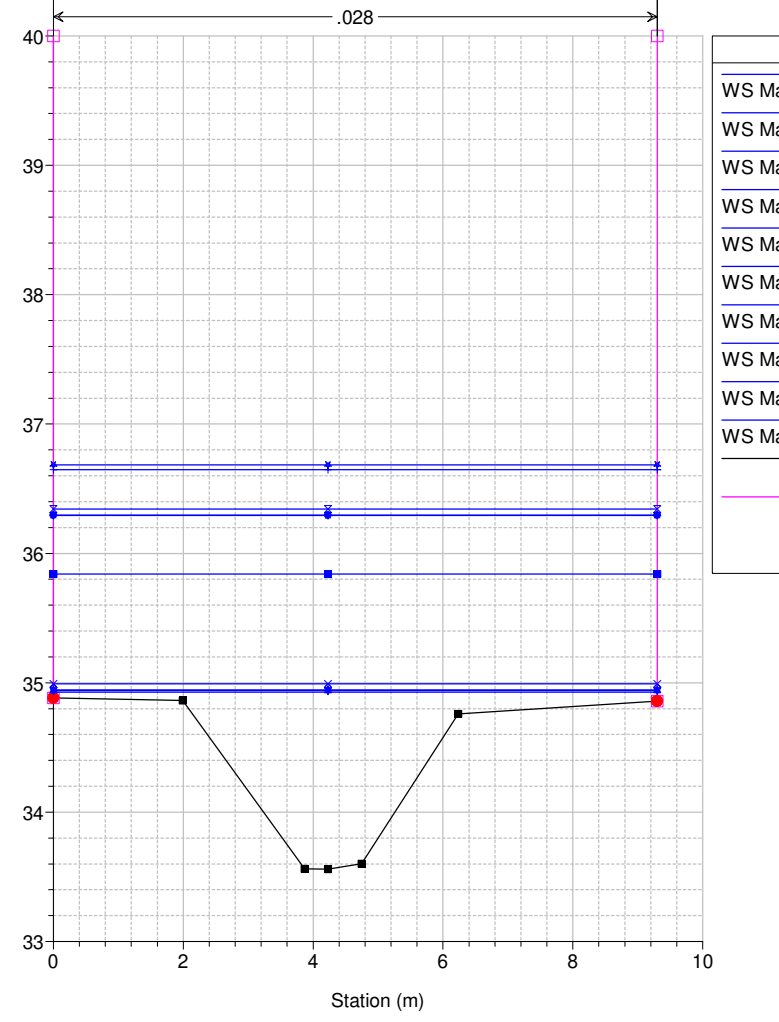

Legend	
WS Max WS - TR200_24_0	▲
WS Max WS - TR200_18_0	+
WS Max WS - TR200_12_0	×
WS Max WS - TR200_09_0	●
WS Max WS - TR200_36_0	■
WS Max WS - TR200_06_0	■
WS Max WS - TR200_03_0	×
WS Max WS - TR200_01_5	▼
WS Max WS - TR200_01_0	▲
WS Max WS - TR200_00_5	▲
Ground	■
Levee	□
Bank Sta	●

Studio Scandicci Torrenti Greve-Vingone
River = Fosso Stagnolo Reach = Stagnolo RS = 94 ST0008_A

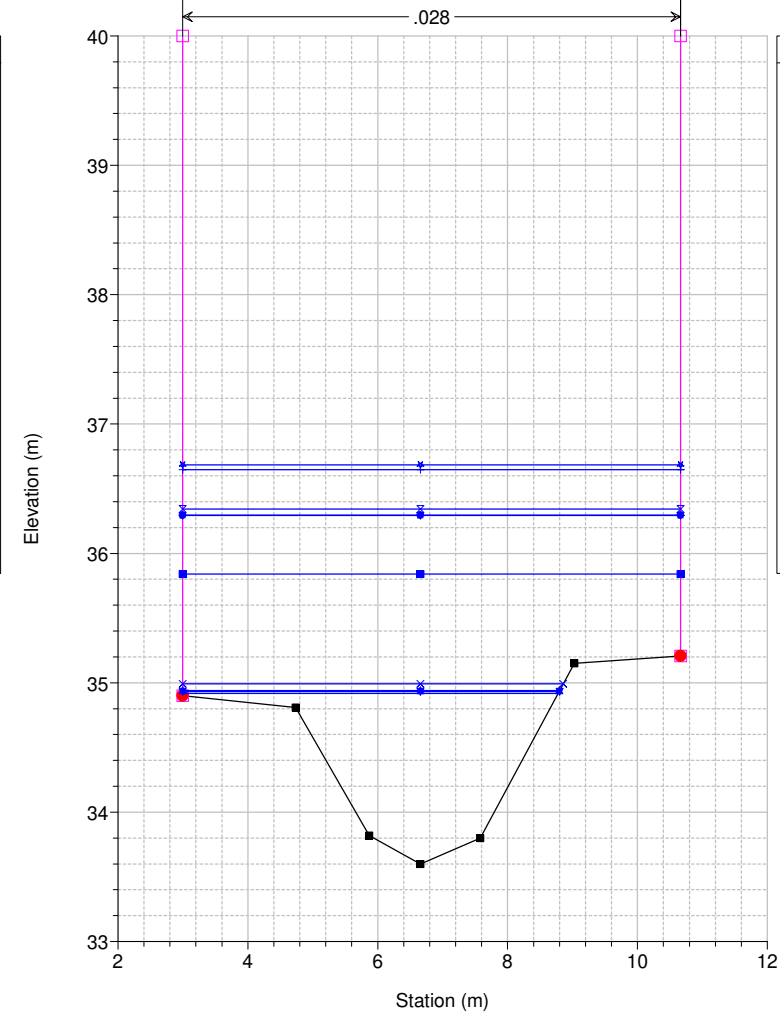

Legend	
WS Max WS - TR200_24_0	▲
WS Max WS - TR200_18_0	+
WS Max WS - TR200_12_0	×
WS Max WS - TR200_09_0	●
WS Max WS - TR200_36_0	■
WS Max WS - TR200_06_0	■
WS Max WS - TR200_03_0	×
WS Max WS - TR200_01_5	▼
WS Max WS - TR200_01_0	▲
WS Max WS - TR200_00_5	▲
Ground	■
Levee	□
Bank Sta	●

Studio Scandicci Torrenti Greve-Vingone
River = Fosso Stagnolo Reach = Stagnolo RS = 93 ST0008_B

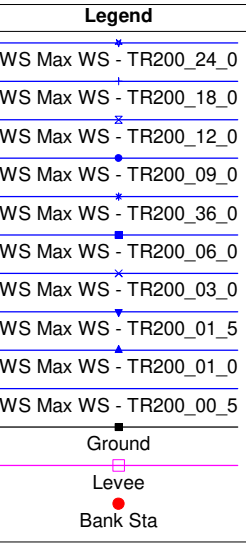
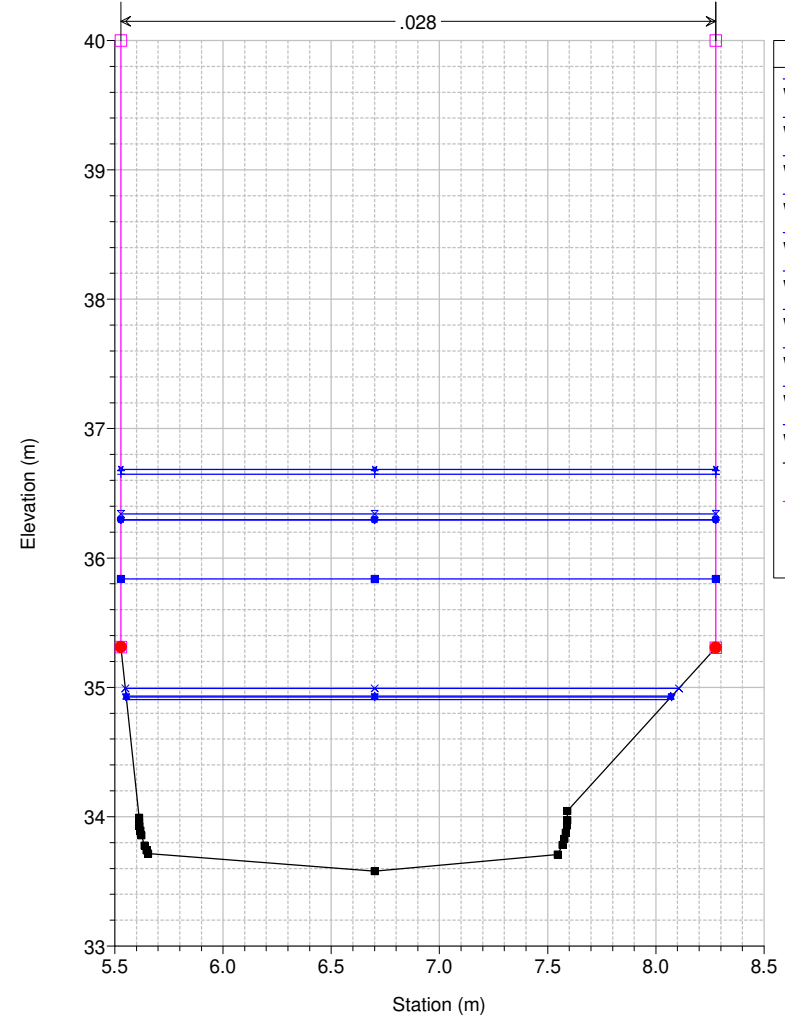

Studio Scandicci Torrenti Greve-Vingone
River = Fosso Stagnolo Reach = Stagnolo RS = 92.5 BR

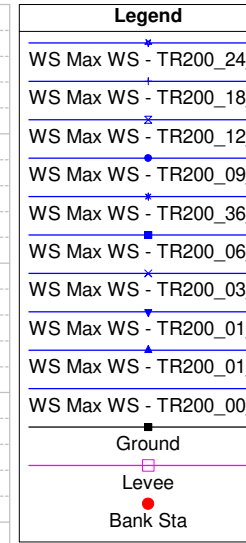
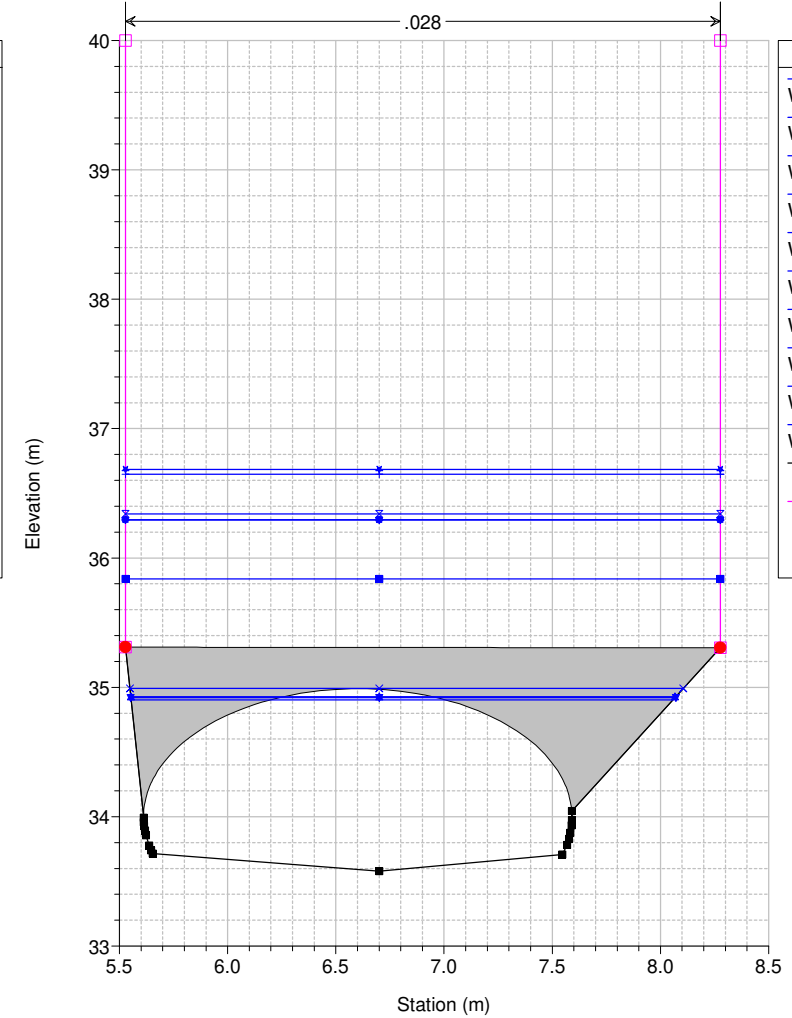

Studio Scandicci Torrenti Greve-Vingone
River = Fosso Stagnolo Reach = Stagnolo RS = 92.5 BR

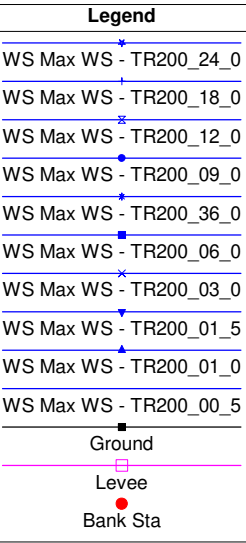
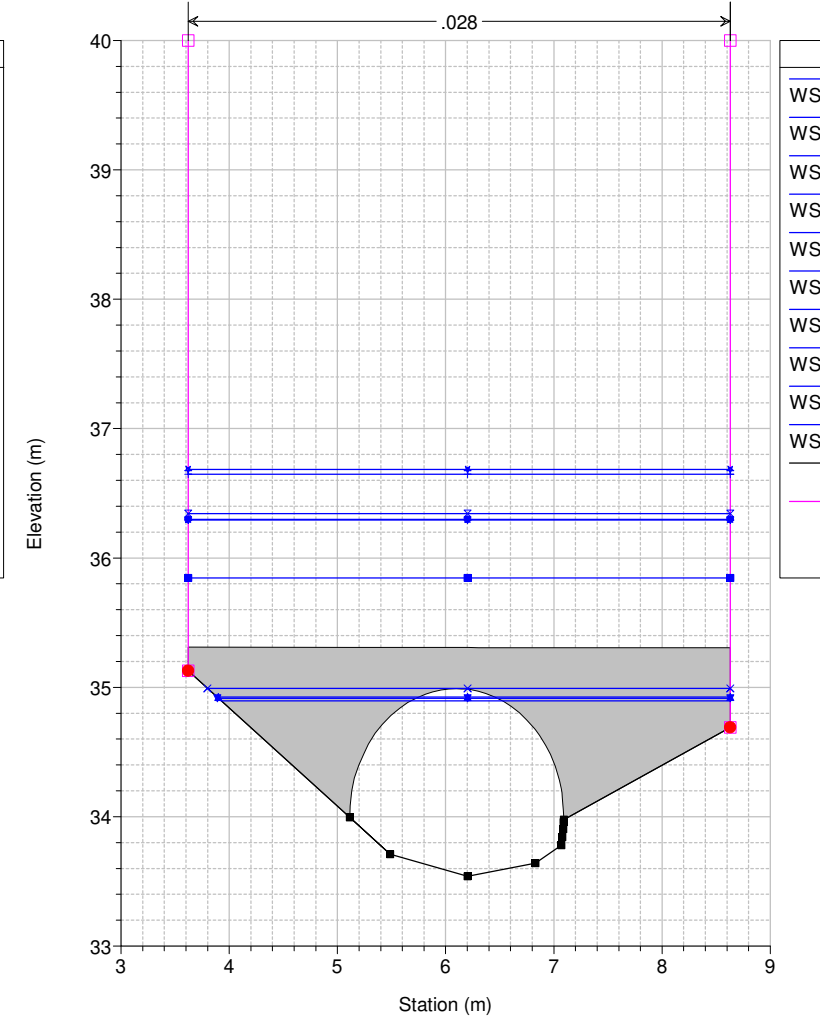

Studio Scandicci Torrenti Greve-Vingone
River = Fosso Stagnolo Reach = Stagnolo RS = 92 ST0008_C

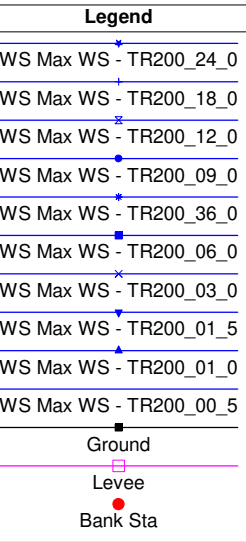
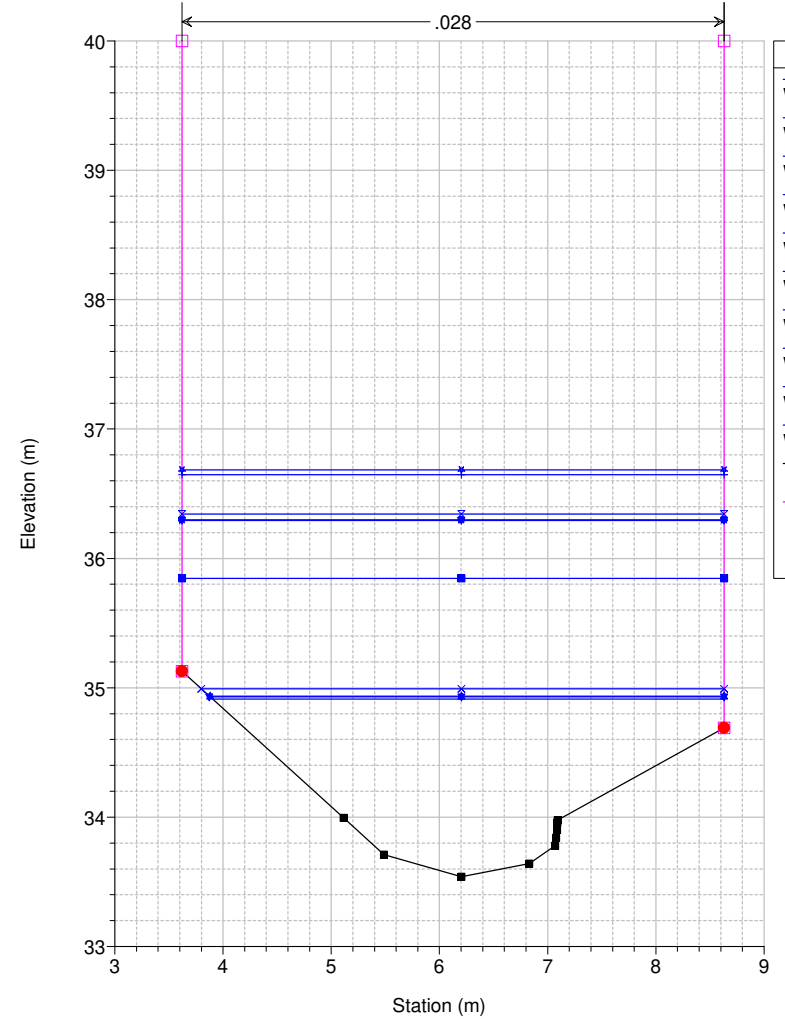

Studio Scandicci Torrenti Greve-Vingone
River = Fosso Stagnolo Reach = Stagnolo RS = 91 ST0008_D

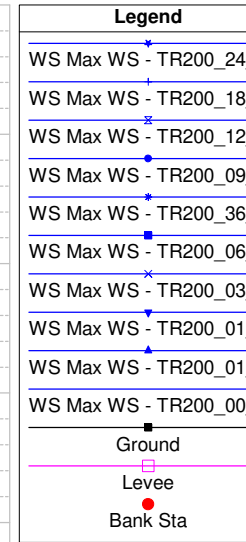
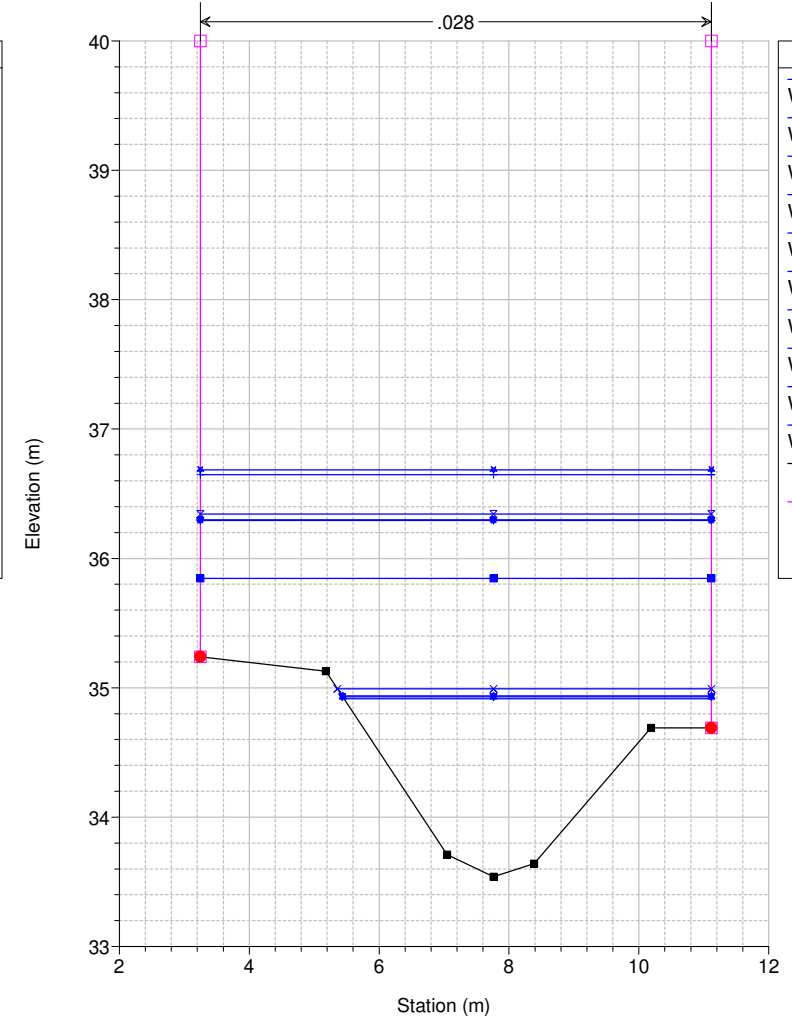

Studio Scandicci Torrenti Greve-Vingone
River = Fosso Stagnolo Reach = Stagnolo RS = 90 ST0009_

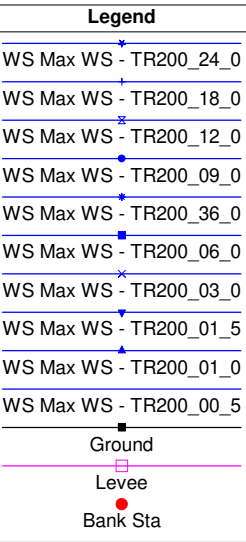
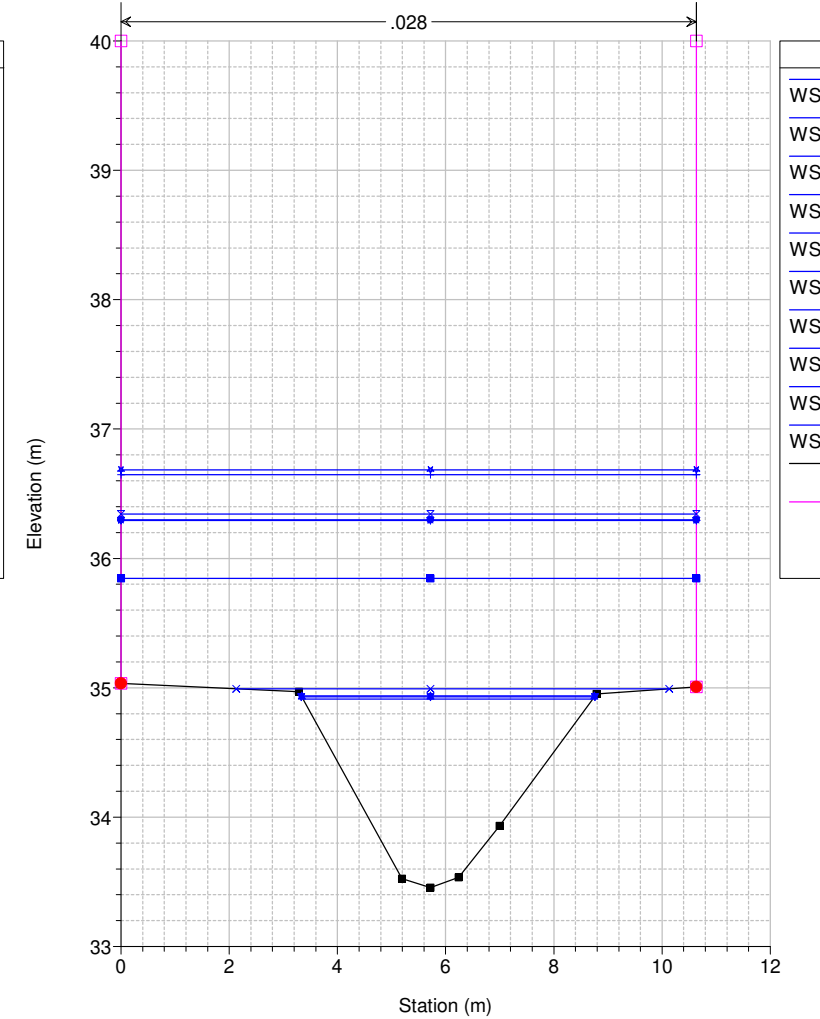

Studio Scandicci Torrenti Greve-Vingone
River = Fosso Stagnolo Reach = Stagnolo RS = 89 ST0010_

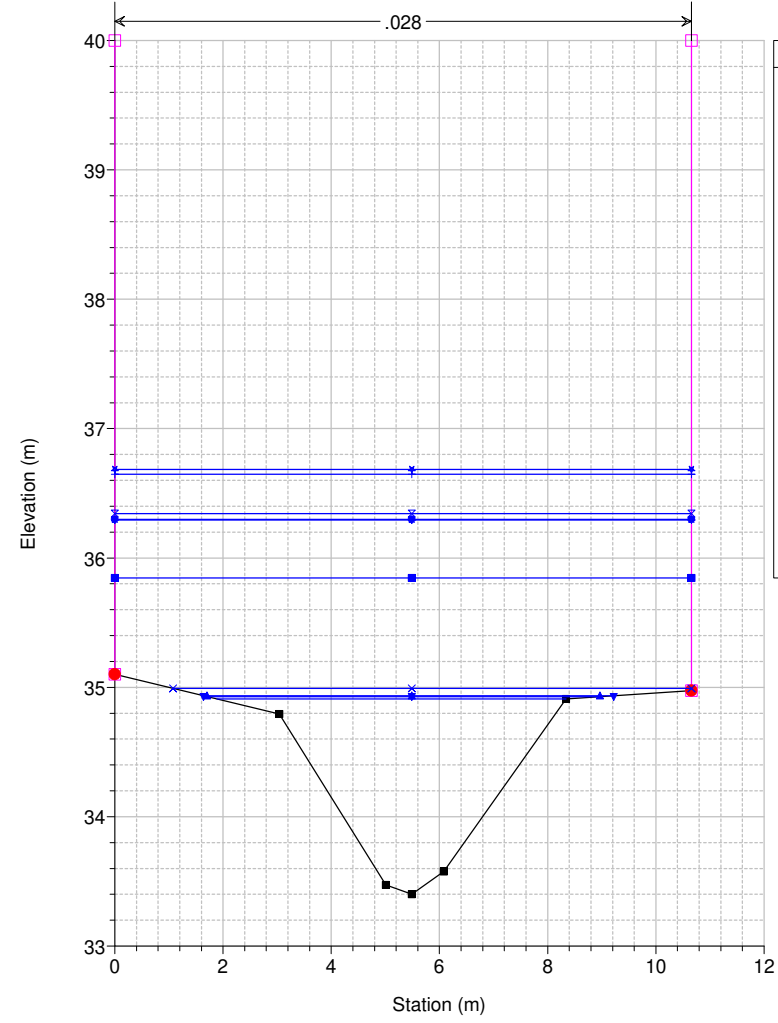

Legend	
WS Max WS - TR200_24_0	+
WS Max WS - TR200_18_0	+
WS Max WS - TR200_12_0	x
WS Max WS - TR200_09_0	•
WS Max WS - TR200_36_0	■
WS Max WS - TR200_06_0	■
WS Max WS - TR200_03_0	x
WS Max WS - TR200_01_5	▼
WS Max WS - TR200_01_0	▲
WS Max WS - TR200_00_5	■
Ground	■
Levee	□
Bank Sta	•

Studio Scandicci Torrenti Greve-Vingone
River = Fosso Stagnolo Reach = Stagnolo RS = 88 ST0011_A

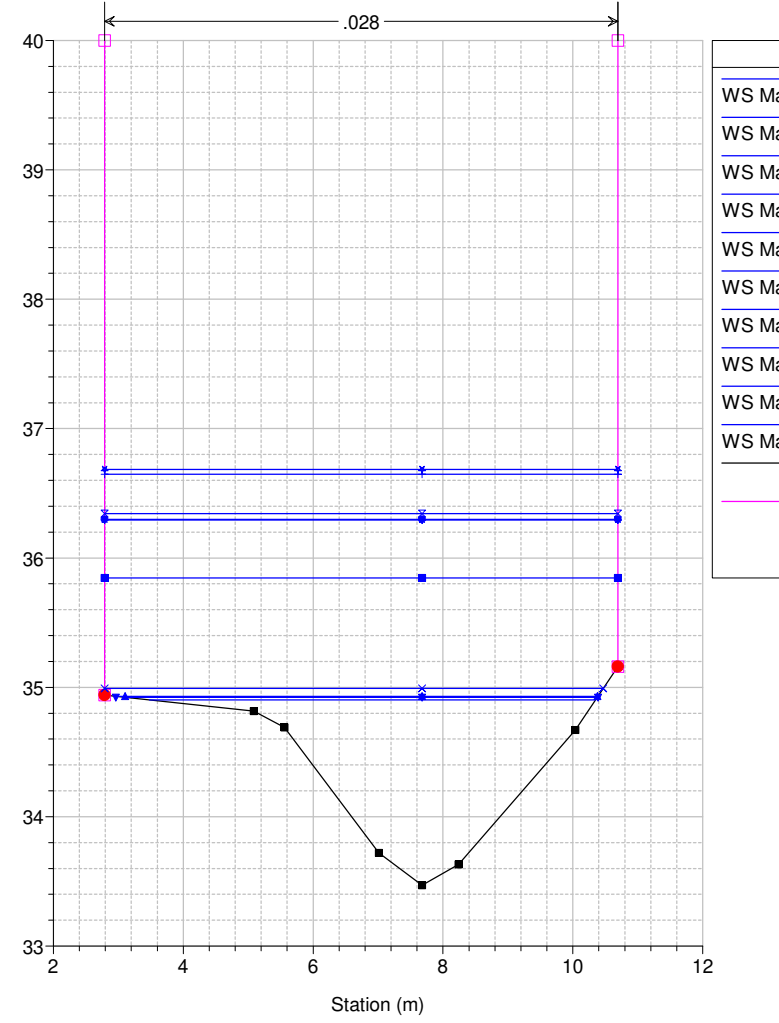

Legend	
WS Max WS - TR200_24_0	+
WS Max WS - TR200_18_0	+
WS Max WS - TR200_12_0	x
WS Max WS - TR200_09_0	•
WS Max WS - TR200_36_0	■
WS Max WS - TR200_06_0	■
WS Max WS - TR200_03_0	x
WS Max WS - TR200_01_5	▼
WS Max WS - TR200_01_0	▲
WS Max WS - TR200_00_5	■
Ground	■
Levee	□
Bank Sta	•

Studio Scandicci Torrenti Greve-Vingone
River = Fosso Stagnolo Reach = Stagnolo RS = 87 ST0011_B

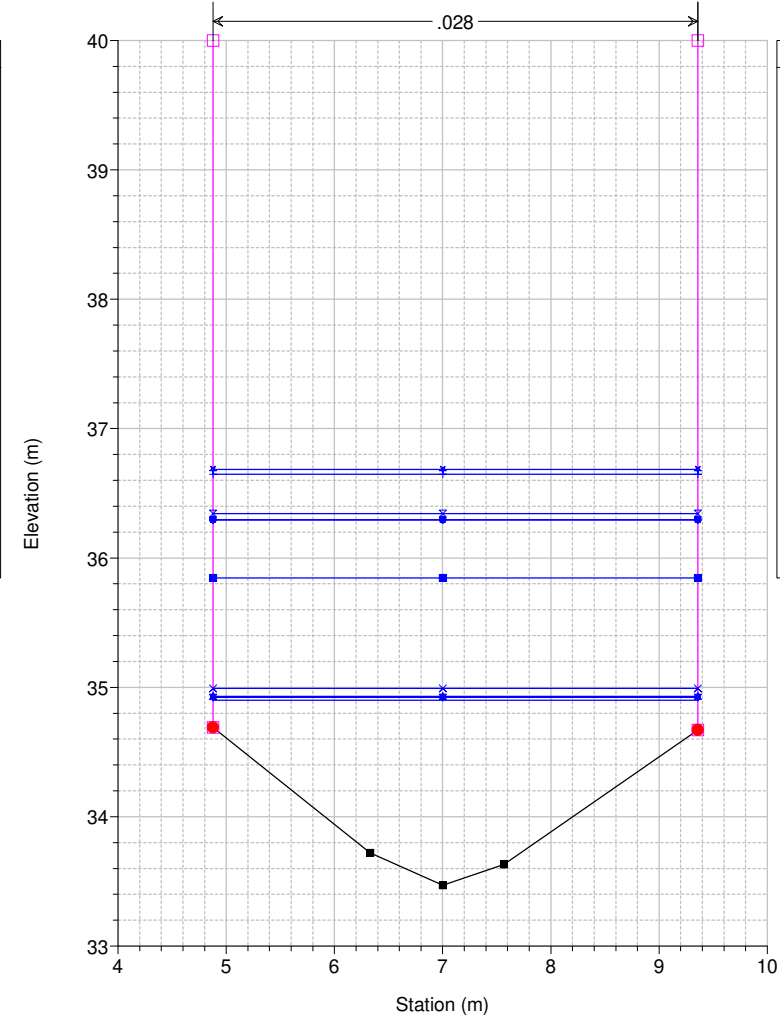

Legend	
WS Max WS - TR200_24_0	+
WS Max WS - TR200_18_0	+
WS Max WS - TR200_12_0	x
WS Max WS - TR200_09_0	•
WS Max WS - TR200_36_0	■
WS Max WS - TR200_06_0	■
WS Max WS - TR200_03_0	x
WS Max WS - TR200_01_5	▼
WS Max WS - TR200_01_0	▲
WS Max WS - TR200_00_5	■
Ground	■
Levee	□
Bank Sta	•

Studio Scandicci Torrenti Greve-Vingone
River = Fosso Stagnolo Reach = Stagnolo RS = 86.5 BR

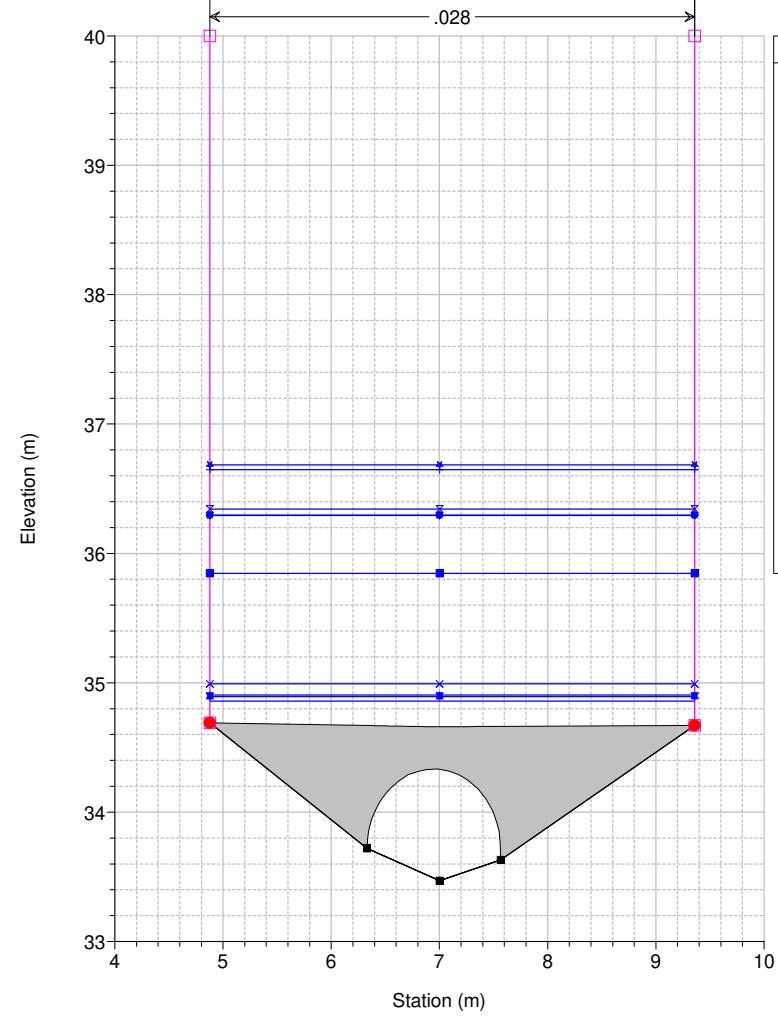

Legend	
WS Max WS - TR200_24_0	+
WS Max WS - TR200_18_0	+
WS Max WS - TR200_12_0	x
WS Max WS - TR200_09_0	•
WS Max WS - TR200_36_0	■
WS Max WS - TR200_06_0	■
WS Max WS - TR200_03_0	x
WS Max WS - TR200_01_5	▼
WS Max WS - TR200_01_0	▲
WS Max WS - TR200_00_5	■
Ground	■
Levee	□
Bank Sta	•

Studio Scandicci Torrenti Greve-Vingone
River = Fosso Stagnolo Reach = Stagnolo RS = 86.5 BR

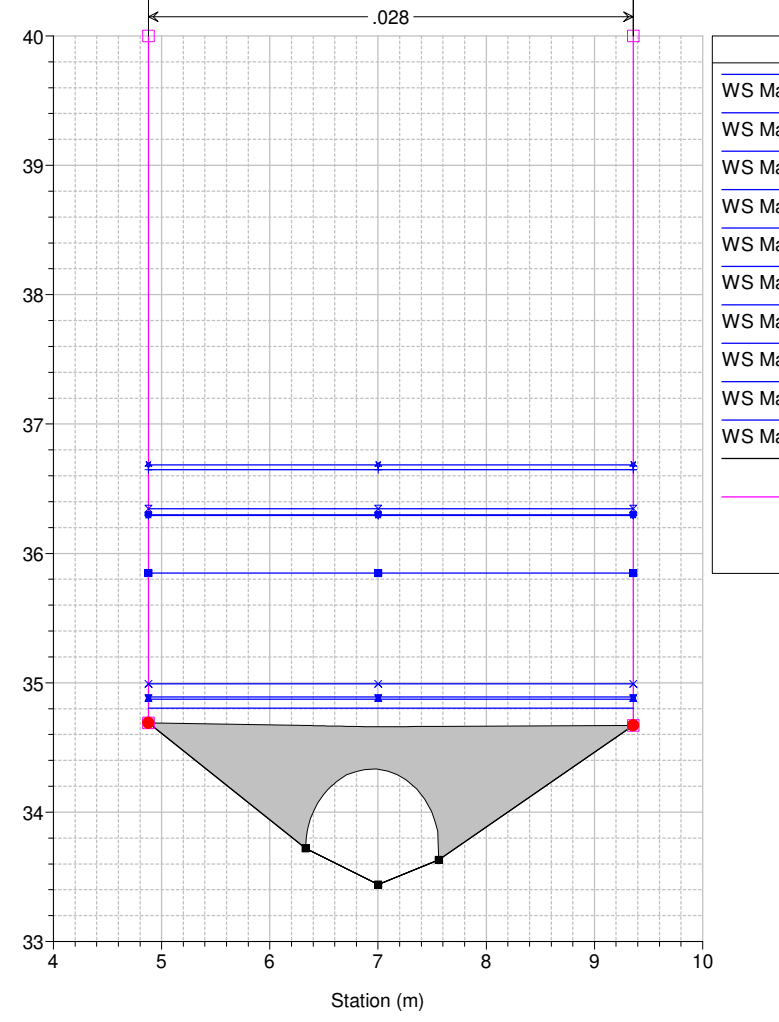

Legend	
WS Max WS - TR200_24_0	+
WS Max WS - TR200_18_0	+
WS Max WS - TR200_12_0	x
WS Max WS - TR200_09_0	•
WS Max WS - TR200_36_0	■
WS Max WS - TR200_06_0	■
WS Max WS - TR200_03_0	x
WS Max WS - TR200_01_5	▼
WS Max WS - TR200_01_0	▲
WS Max WS - TR200_00_5	■
Ground	■
Levee	□
Bank Sta	•

Studio Scandicci Torrenti Greve-Vingone
River = Fosso Stagnolo Reach = Stagnolo RS = 86 ST0011_C

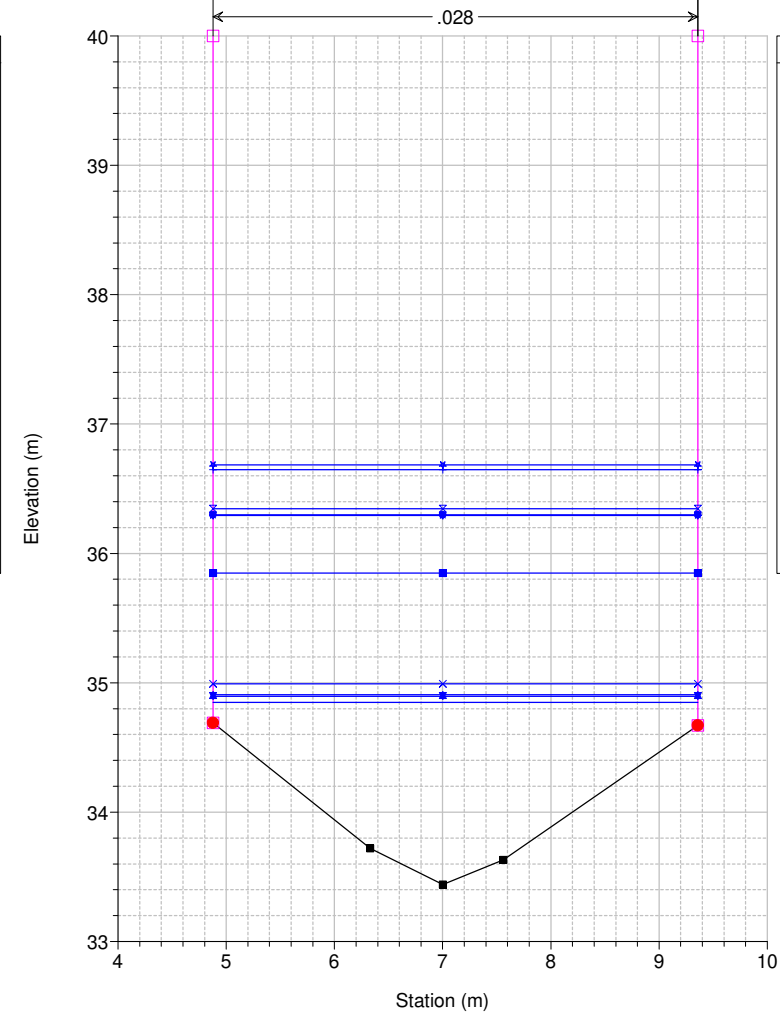

Legend	
WS Max WS - TR200_24_0	+
WS Max WS - TR200_18_0	+
WS Max WS - TR200_12_0	x
WS Max WS - TR200_09_0	•
WS Max WS - TR200_36_0	■
WS Max WS - TR200_06_0	■
WS Max WS - TR200_03_0	x
WS Max WS - TR200_01_5	▼
WS Max WS - TR200_01_0	▲
WS Max WS - TR200_00_5	■
Ground	■
Levee	□
Bank Sta	•

Studio Scandicci Torrenti Greve-Vingone
River = Fosso Stagnolo Reach = Stagnolo RS = 85 ST0011_D

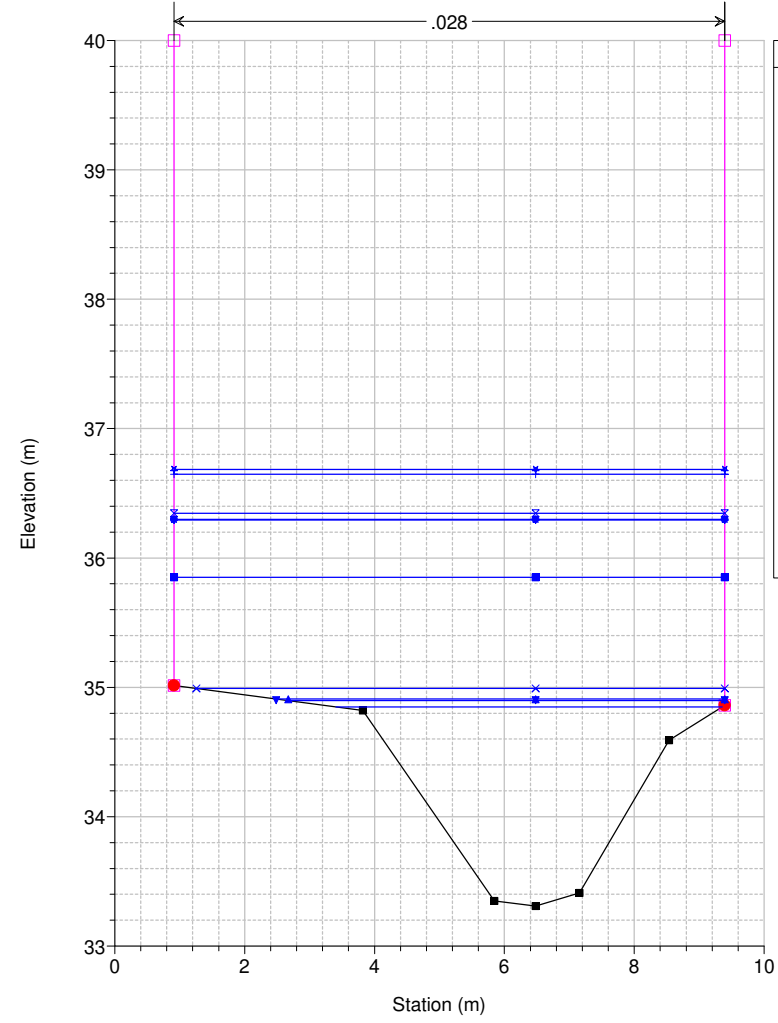

Legend	
WS Max WS - TR200_24_0	+
WS Max WS - TR200_18_0	+
WS Max WS - TR200_12_0	x
WS Max WS - TR200_09_0	•
WS Max WS - TR200_36_0	■
WS Max WS - TR200_06_0	■
WS Max WS - TR200_03_0	x
WS Max WS - TR200_01_5	▼
WS Max WS - TR200_01_0	▲
WS Max WS - TR200_00_5	■
Ground	—
Levee	□
Bank Sta	•

Studio Scandicci Torrenti Greve-Vingone
River = Fosso Stagnolo Reach = Stagnolo RS = 84 ST0012_

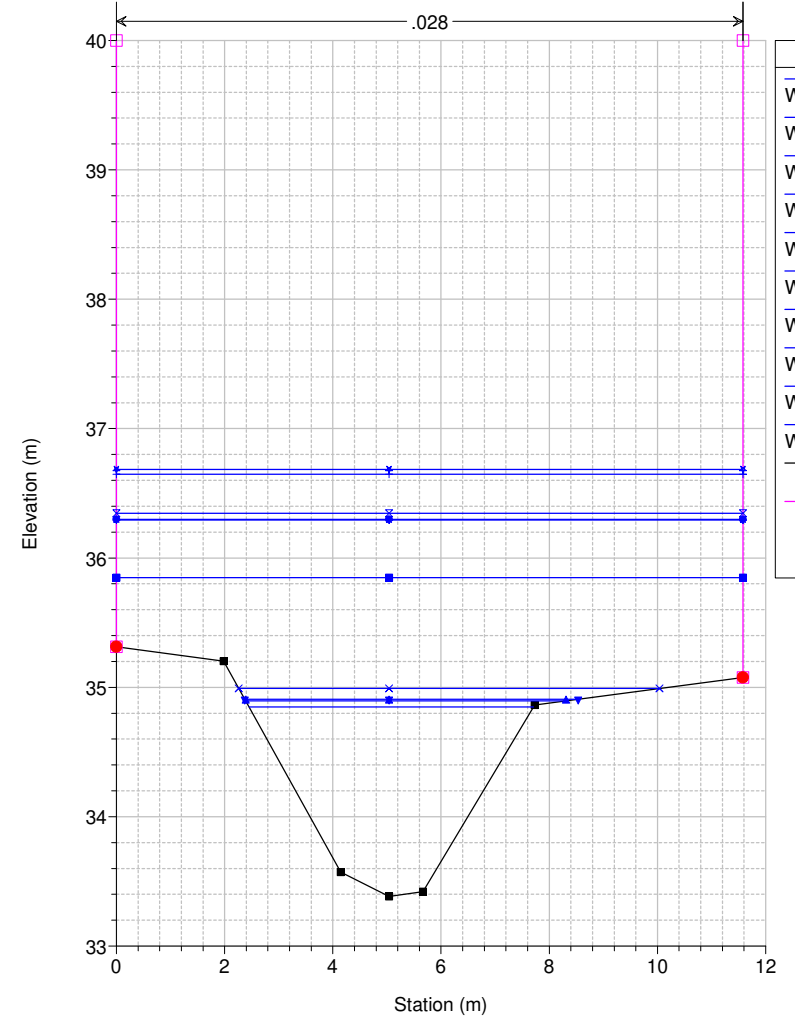

Legend	
WS Max WS - TR200_24_0	+
WS Max WS - TR200_18_0	+
WS Max WS - TR200_12_0	x
WS Max WS - TR200_09_0	•
WS Max WS - TR200_36_0	■
WS Max WS - TR200_06_0	■
WS Max WS - TR200_03_0	x
WS Max WS - TR200_01_5	▼
WS Max WS - TR200_01_0	▲
WS Max WS - TR200_00_5	■
Ground	—
Levee	□
Bank Sta	•

Studio Scandicci Torrenti Greve-Vingone
River = Fosso Stagnolo Reach = Stagnolo RS = 83 ST0013_

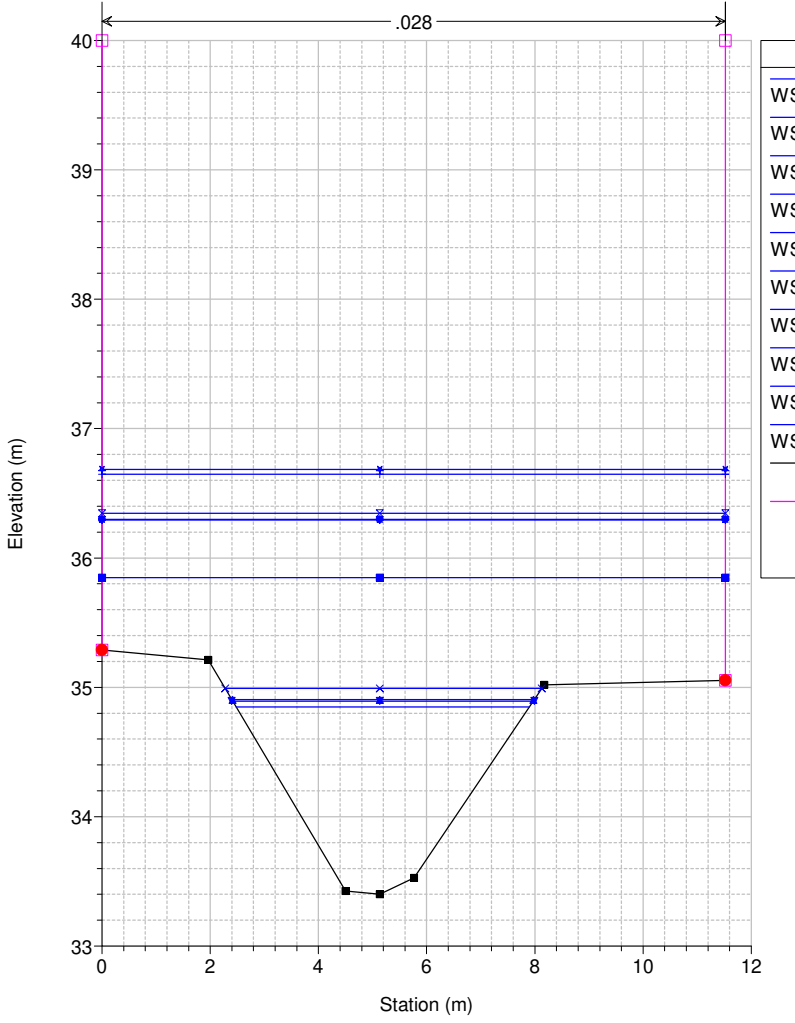

Legend	
WS Max WS - TR200_24_0	+
WS Max WS - TR200_18_0	+
WS Max WS - TR200_12_0	x
WS Max WS - TR200_09_0	•
WS Max WS - TR200_36_0	■
WS Max WS - TR200_06_0	■
WS Max WS - TR200_03_0	x
WS Max WS - TR200_01_5	▼
WS Max WS - TR200_01_0	▲
WS Max WS - TR200_00_5	■
Ground	—
Levee	□
Bank Sta	•

Studio Scandicci Torrenti Greve-Vingone
River = Fosso Stagnolo Reach = Stagnolo RS = 82 ST0014_

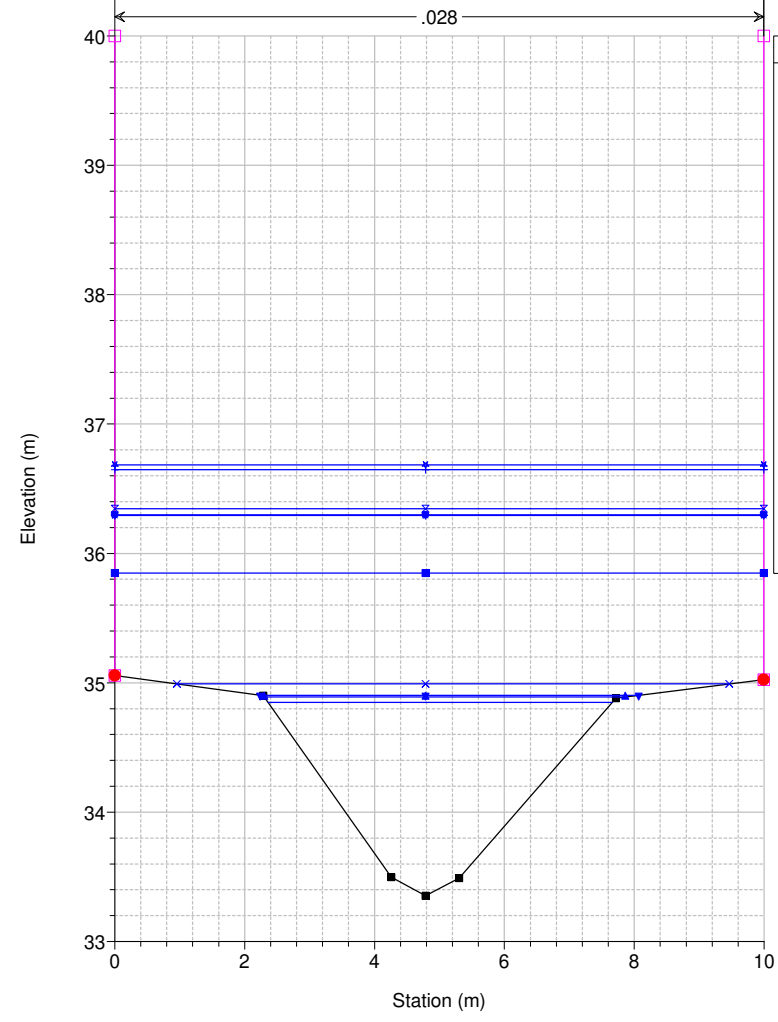

Legend	
WS Max WS - TR200_24_0	+
WS Max WS - TR200_18_0	+
WS Max WS - TR200_12_0	x
WS Max WS - TR200_09_0	•
WS Max WS - TR200_36_0	■
WS Max WS - TR200_06_0	■
WS Max WS - TR200_03_0	x
WS Max WS - TR200_01_5	▼
WS Max WS - TR200_01_0	▲
WS Max WS - TR200_00_5	■
Ground	—
Levee	□
Bank Sta	•

Studio Scandicci Torrenti Greve-Vingone
River = Fosso Stagnolo Reach = Stagnolo RS = 81 ST0015_

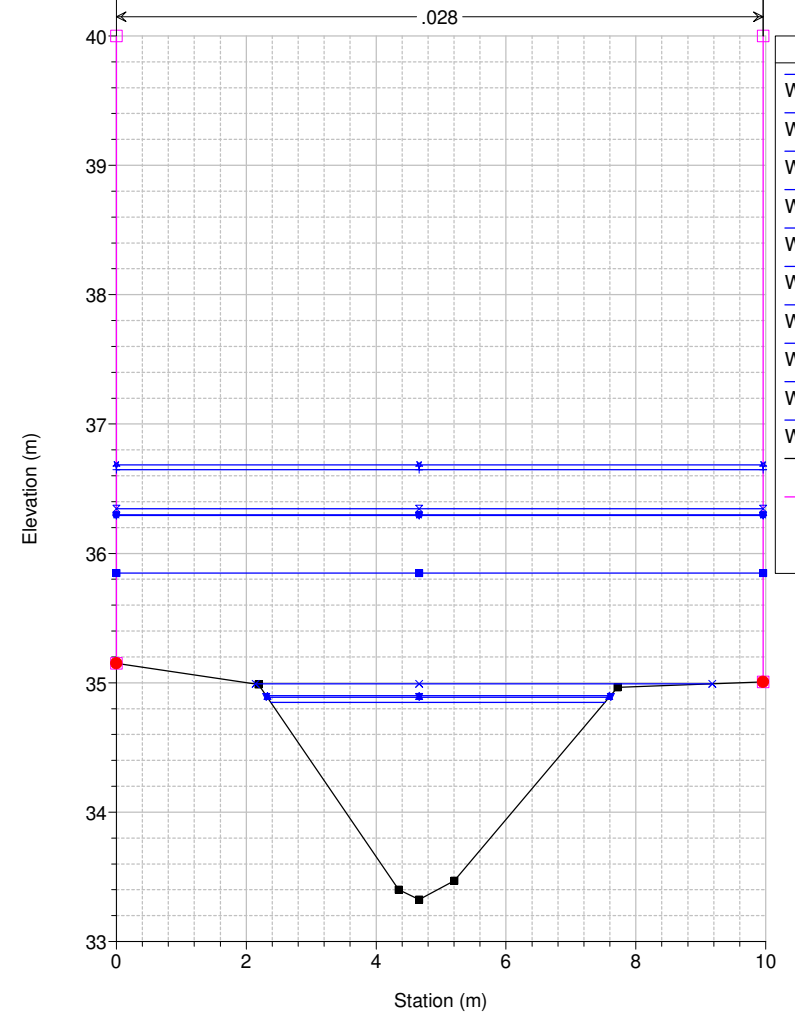

Legend	
WS Max WS - TR200_24_0	+
WS Max WS - TR200_18_0	+
WS Max WS - TR200_12_0	x
WS Max WS - TR200_09_0	•
WS Max WS - TR200_36_0	■
WS Max WS - TR200_06_0	■
WS Max WS - TR200_03_0	x
WS Max WS - TR200_01_5	▼
WS Max WS - TR200_01_0	▲
WS Max WS - TR200_00_5	■
Ground	—
Levee	□
Bank Sta	•

Studio Scandicci Torrenti Greve-Vingone
River = Fosso Stagnolo Reach = Stagnolo RS = 80 ST0016_

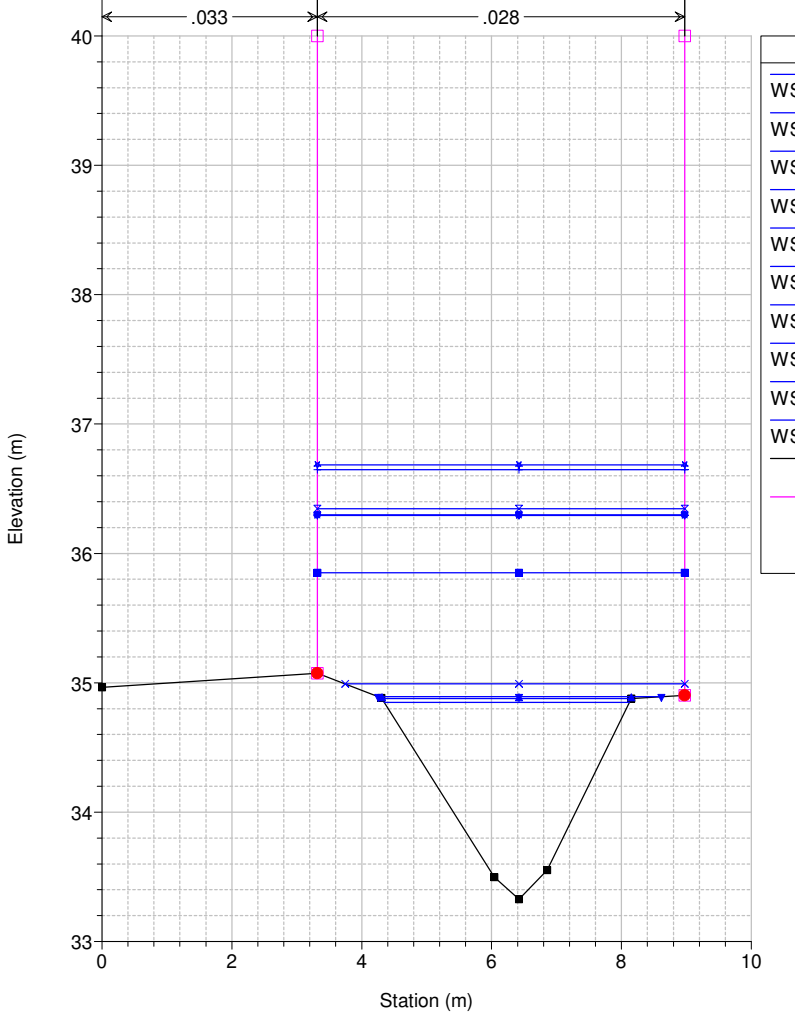

Legend	
WS Max WS - TR200_24_0	+
WS Max WS - TR200_18_0	+
WS Max WS - TR200_12_0	x
WS Max WS - TR200_09_0	•
WS Max WS - TR200_36_0	■
WS Max WS - TR200_06_0	■
WS Max WS - TR200_03_0	x
WS Max WS - TR200_01_5	▼
WS Max WS - TR200_01_0	▲
WS Max WS - TR200_00_5	■
Ground	—
Levee	□
Bank Sta	•

Studio Scandicci Torrenti Greve-Vingone
River = Fosso Stagnolo Reach = Stagnolo RS = 79 ST0017__

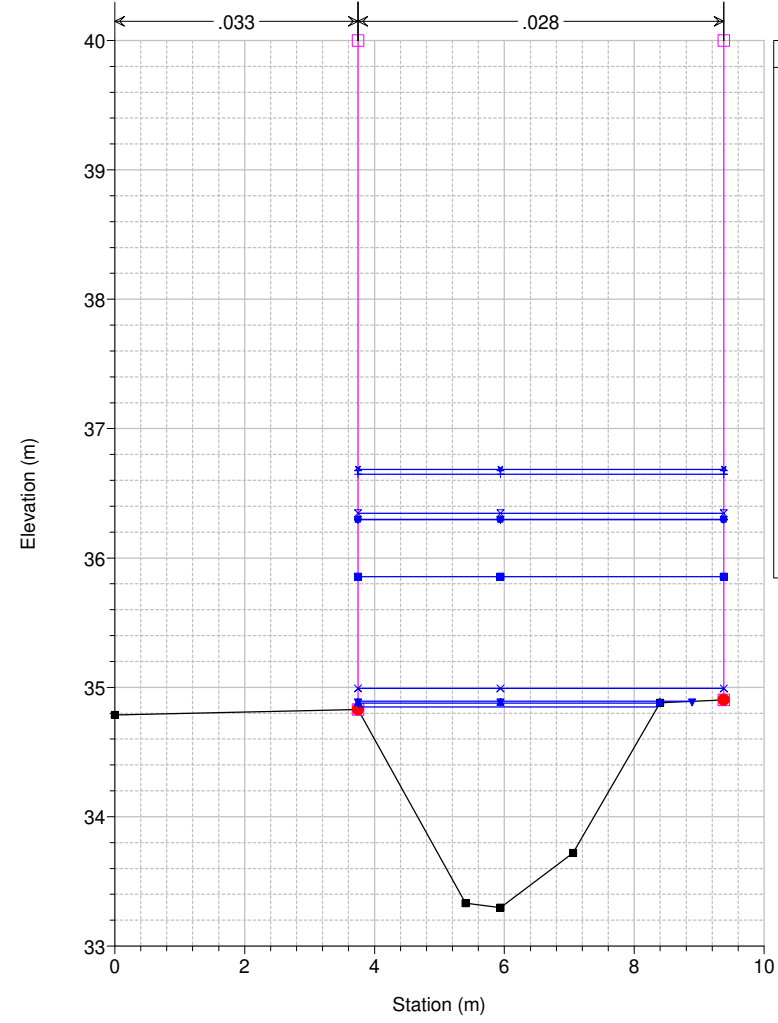

Legend

- WS Max WS - TR200_24_0
- WS Max WS - TR200_18_0
- WS Max WS - TR200_12_0
- WS Max WS - TR200_09_0
- WS Max WS - TR200_36_0
- WS Max WS - TR200_06_0
- WS Max WS - TR200_03_0
- WS Max WS - TR200_01_5
- WS Max WS - TR200_01_0
- WS Max WS - TR200_00_5
- Ground
- Levee
- Bank Sta

Studio Scandicci Torrenti Greve-Vingone
River = Fosso Stagnolo Reach = Stagnolo RS = 78 ST0018__

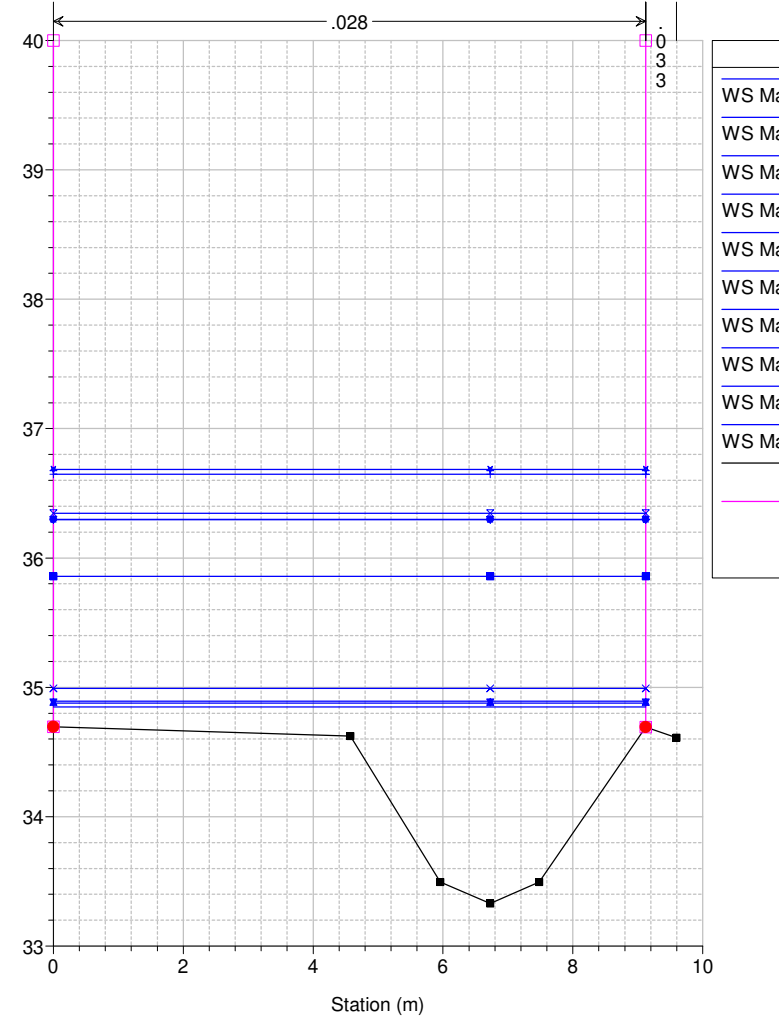

Legend

- WS Max WS - TR200_24_0
- WS Max WS - TR200_18_0
- WS Max WS - TR200_12_0
- WS Max WS - TR200_09_0
- WS Max WS - TR200_36_0
- WS Max WS - TR200_06_0
- WS Max WS - TR200_03_0
- WS Max WS - TR200_01_5
- WS Max WS - TR200_01_0
- WS Max WS - TR200_00_5
- Ground
- Levee
- Bank Sta

Studio Scandicci Torrenti Greve-Vingone
River = Fosso Stagnolo Reach = Stagnolo RS = 77 ST0019_A

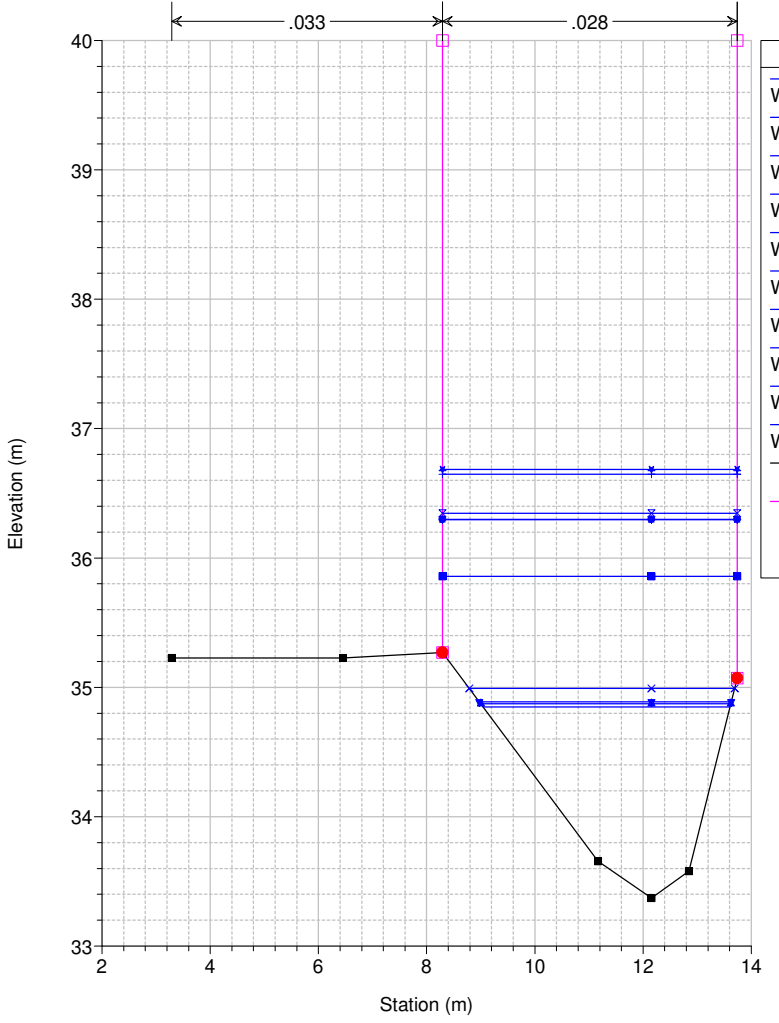

Legend

- WS Max WS - TR200_24_0
- WS Max WS - TR200_18_0
- WS Max WS - TR200_12_0
- WS Max WS - TR200_09_0
- WS Max WS - TR200_36_0
- WS Max WS - TR200_06_0
- WS Max WS - TR200_03_0
- WS Max WS - TR200_01_5
- WS Max WS - TR200_01_0
- WS Max WS - TR200_00_5
- Ground
- Levee
- Bank Sta

Studio Scandicci Torrenti Greve-Vingone
River = Fosso Stagnolo Reach = Stagnolo RS = 76 ST0019_B

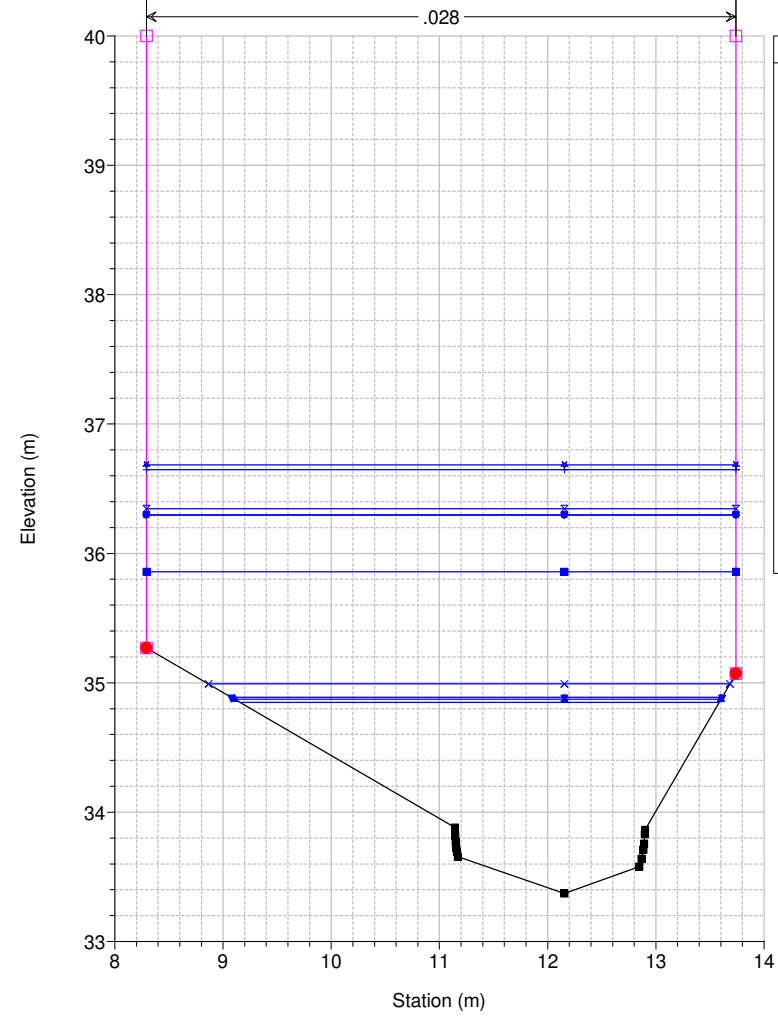

Legend

- WS Max WS - TR200_24_0
- WS Max WS - TR200_18_0
- WS Max WS - TR200_12_0
- WS Max WS - TR200_09_0
- WS Max WS - TR200_36_0
- WS Max WS - TR200_06_0
- WS Max WS - TR200_03_0
- WS Max WS - TR200_01_5
- WS Max WS - TR200_01_0
- WS Max WS - TR200_00_5
- Ground
- Levee
- Bank Sta

Studio Scandicci Torrenti Greve-Vingone
River = Fosso Stagnolo Reach = Stagnolo RS = 75.5 BR

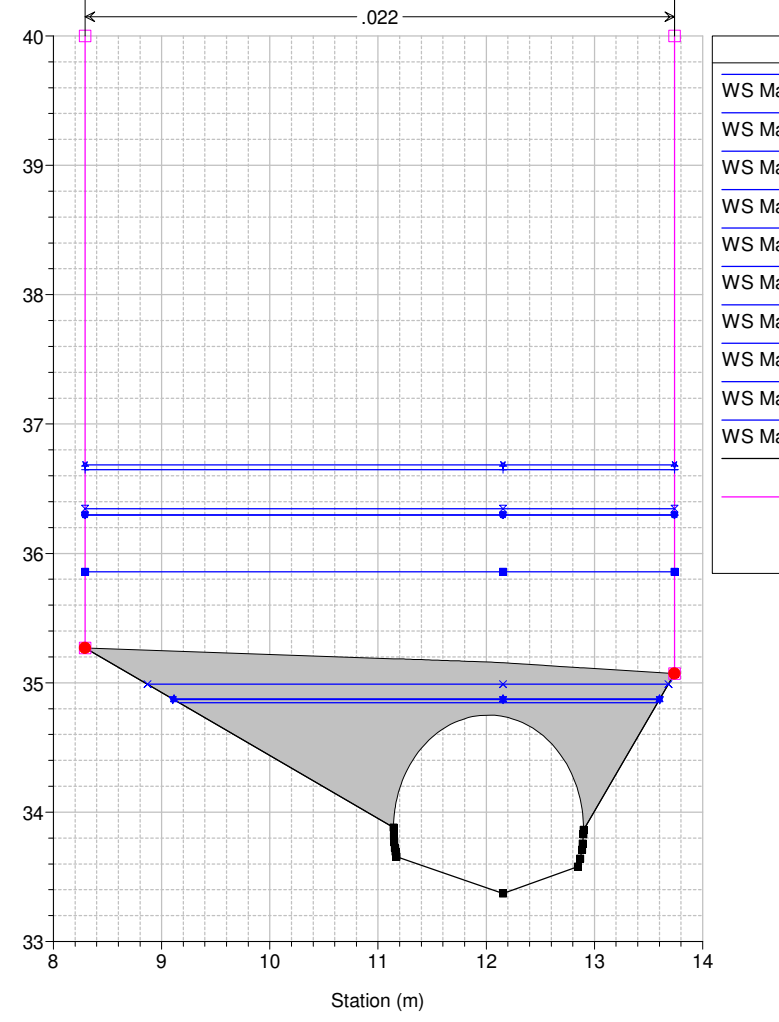

Legend

- WS Max WS - TR200_24_0
- WS Max WS - TR200_18_0
- WS Max WS - TR200_12_0
- WS Max WS - TR200_09_0
- WS Max WS - TR200_36_0
- WS Max WS - TR200_06_0
- WS Max WS - TR200_03_0
- WS Max WS - TR200_01_5
- WS Max WS - TR200_01_0
- WS Max WS - TR200_00_5
- Ground
- Levee
- Bank Sta

Studio Scandicci Torrenti Greve-Vingone
River = Fosso Stagnolo Reach = Stagnolo RS = 75.5 BR

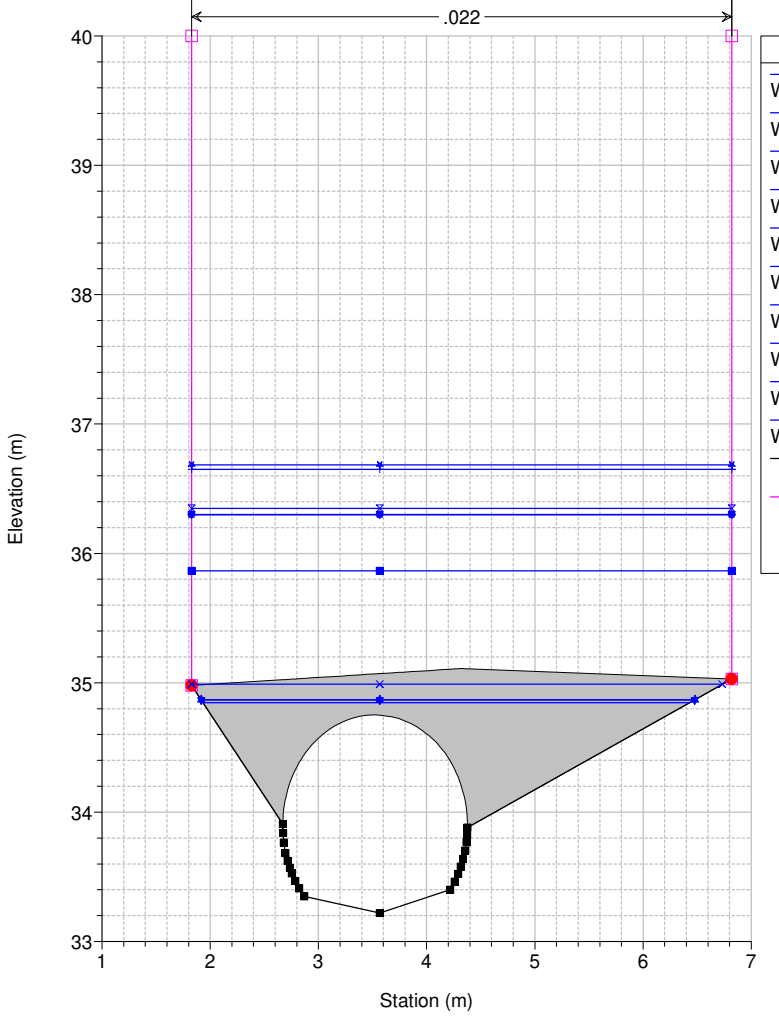

Legend

- WS Max WS - TR200_24_0
- WS Max WS - TR200_18_0
- WS Max WS - TR200_12_0
- WS Max WS - TR200_09_0
- WS Max WS - TR200_36_0
- WS Max WS - TR200_06_0
- WS Max WS - TR200_03_0
- WS Max WS - TR200_01_5
- WS Max WS - TR200_01_0
- WS Max WS - TR200_00_5
- Ground
- Levee
- Bank Sta

Studio Scandicci Torrenti Greve-Vingone
River = Fosso Stagnolo Reach = Stagnolo RS = 75 ST0019_C

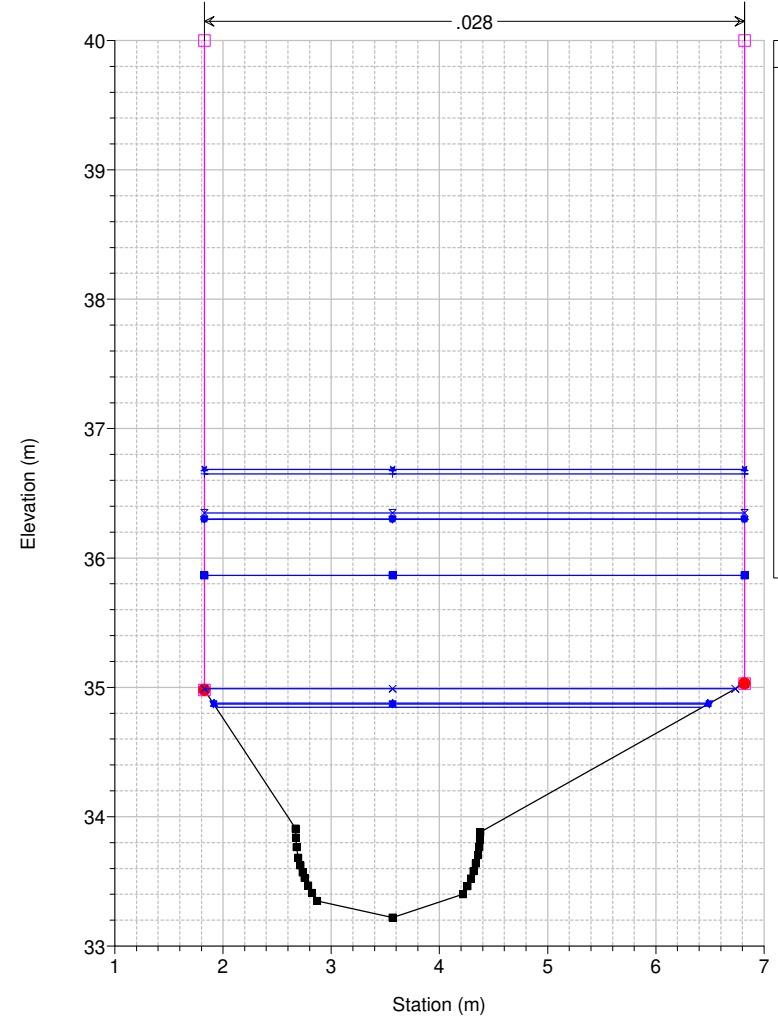

Legend	
WS Max WS - TR200_24_0	+
WS Max WS - TR200_18_0	+
WS Max WS - TR200_12_0	x
WS Max WS - TR200_09_0	•
WS Max WS - TR200_36_0	•
WS Max WS - TR200_06_0	•
WS Max WS - TR200_03_0	x
WS Max WS - TR200_01_5	v
WS Max WS - TR200_01_0	▲
WS Max WS - TR200_00_5	▲
Ground	■
Levee	□
Bank Sta	●

Studio Scandicci Torrenti Greve-Vingone
River = Fosso Stagnolo Reach = Stagnolo RS = 74 ST0019_D

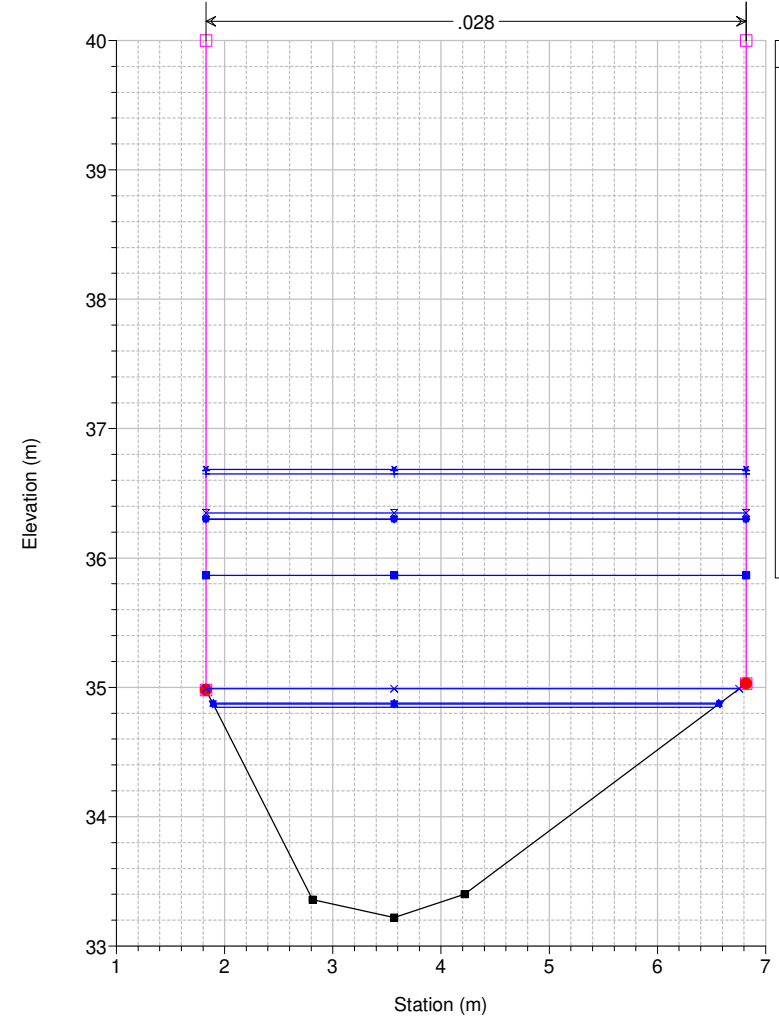

Legend	
WS Max WS - TR200_24_0	+
WS Max WS - TR200_18_0	+
WS Max WS - TR200_12_0	x
WS Max WS - TR200_09_0	•
WS Max WS - TR200_36_0	•
WS Max WS - TR200_06_0	•
WS Max WS - TR200_03_0	x
WS Max WS - TR200_01_5	v
WS Max WS - TR200_01_0	▲
WS Max WS - TR200_00_5	▲
Ground	■
Levee	□
Bank Sta	●

Studio Scandicci Torrenti Greve-Vingone
River = Fosso Stagnolo Reach = Stagnolo RS = 73 ST0020__

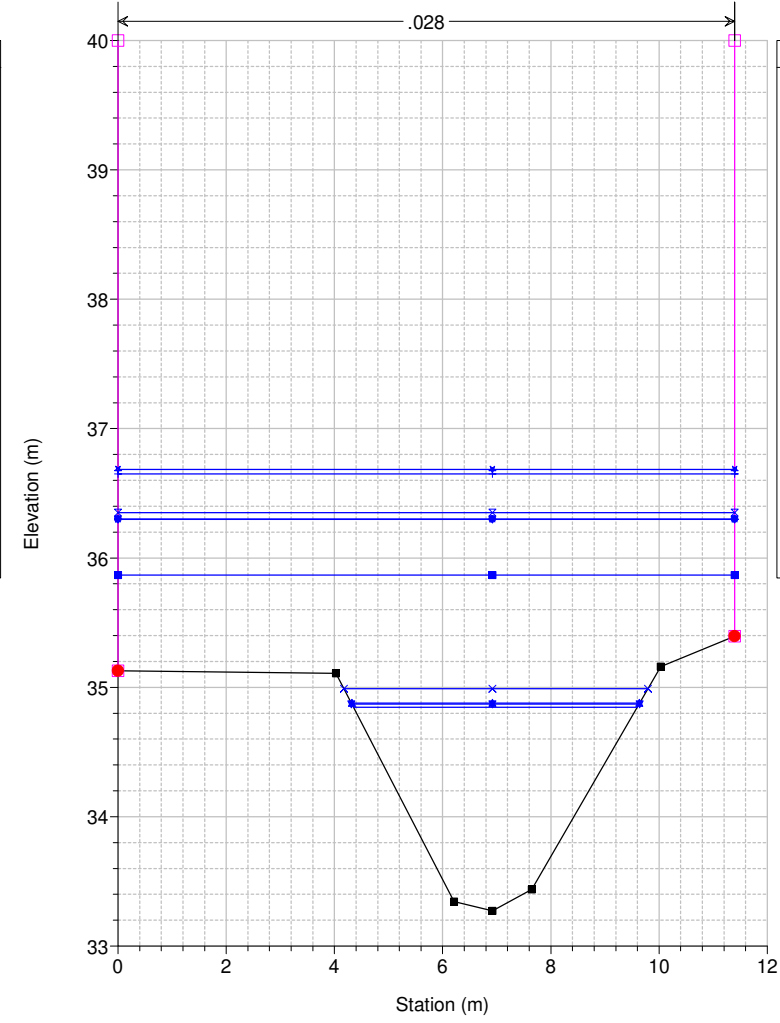

Legend	
WS Max WS - TR200_24_0	+
WS Max WS - TR200_18_0	+
WS Max WS - TR200_12_0	x
WS Max WS - TR200_09_0	•
WS Max WS - TR200_36_0	•
WS Max WS - TR200_06_0	•
WS Max WS - TR200_03_0	x
WS Max WS - TR200_01_5	v
WS Max WS - TR200_01_0	▲
WS Max WS - TR200_00_5	▲
Ground	■
Levee	□
Bank Sta	●

Studio Scandicci Torrenti Greve-Vingone
River = Fosso Stagnolo Reach = Stagnolo RS = 72 ST0021_A

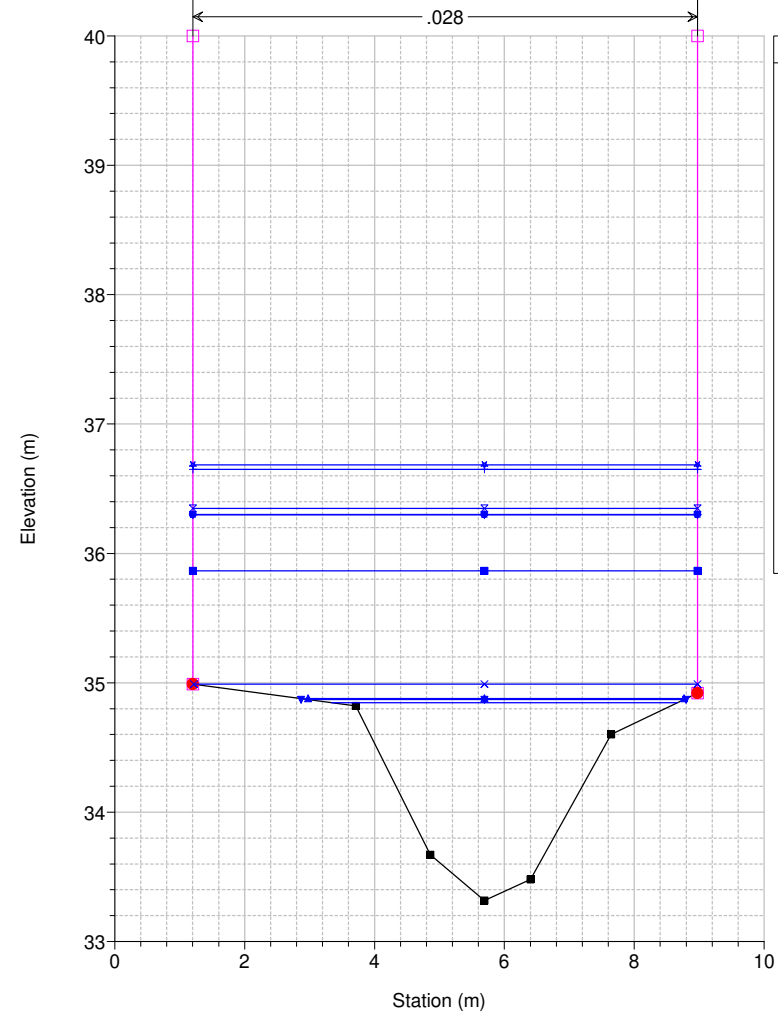

Legend	
WS Max WS - TR200_24_0	+
WS Max WS - TR200_18_0	+
WS Max WS - TR200_12_0	x
WS Max WS - TR200_09_0	•
WS Max WS - TR200_36_0	•
WS Max WS - TR200_06_0	•
WS Max WS - TR200_03_0	x
WS Max WS - TR200_01_5	v
WS Max WS - TR200_01_0	▲
WS Max WS - TR200_00_5	▲
Ground	■
Levee	□
Bank Sta	●

Studio Scandicci Torrenti Greve-Vingone
River = Fosso Stagnolo Reach = Stagnolo RS = 71 ST0021_B

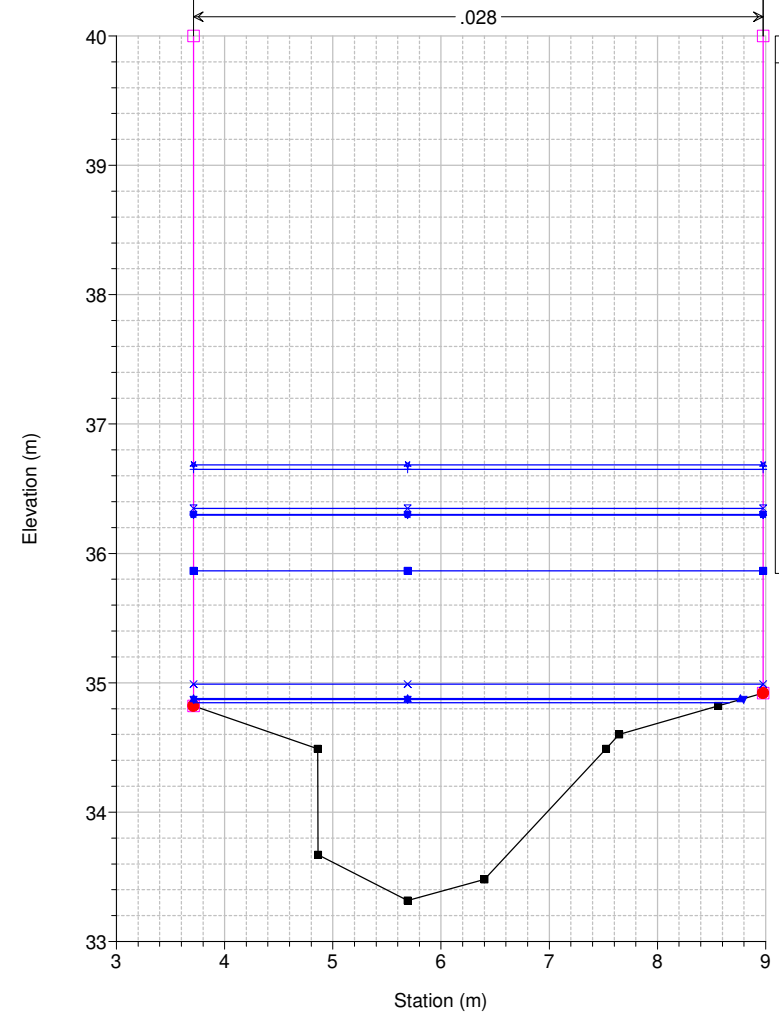

Legend	
WS Max WS - TR200_24_0	+
WS Max WS - TR200_18_0	+
WS Max WS - TR200_12_0	x
WS Max WS - TR200_09_0	•
WS Max WS - TR200_36_0	•
WS Max WS - TR200_06_0	•
WS Max WS - TR200_03_0	x
WS Max WS - TR200_01_5	v
WS Max WS - TR200_01_0	▲
WS Max WS - TR200_00_5	▲
Ground	■
Levee	□
Bank Sta	●

Studio Scandicci Torrenti Greve-Vingone
River = Fosso Stagnolo Reach = Stagnolo RS = 70.5 BR

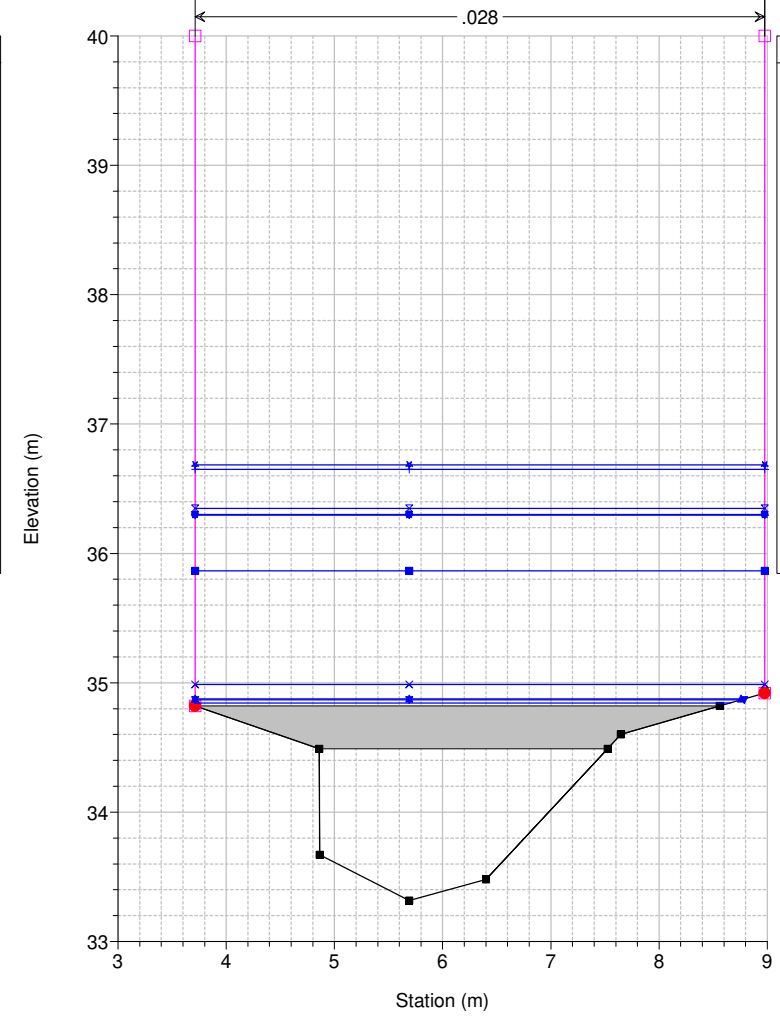

Legend	
WS Max WS - TR200_24_0	+
WS Max WS - TR200_18_0	+
WS Max WS - TR200_12_0	x
WS Max WS - TR200_09_0	•
WS Max WS - TR200_36_0	•
WS Max WS - TR200_06_0	•
WS Max WS - TR200_03_0	x
WS Max WS - TR200_01_5	v
WS Max WS - TR200_01_0	▲
WS Max WS - TR200_00_5	▲
Ground	■
Levee	□
Bank Sta	●

Studio Scandicci Torrenti Greve-Vingone
River = Fosso Stagnolo Reach = Stagnolo RS = 70.5 BR

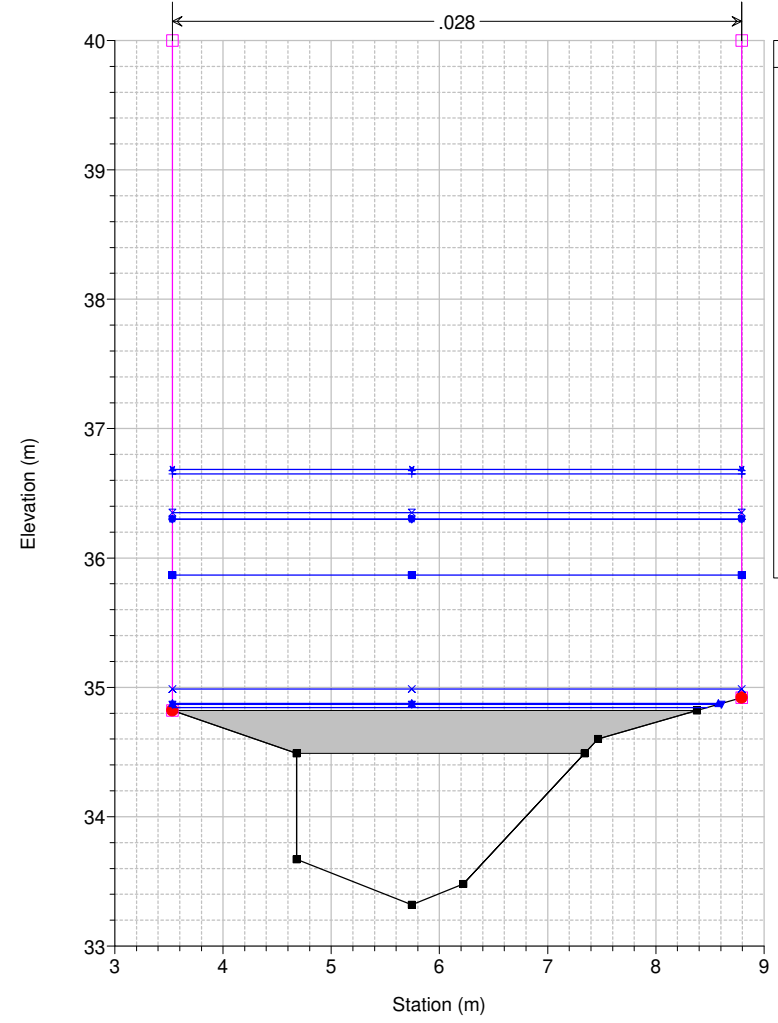

Legend	
WS Max WS - TR200_24_0	✕
WS Max WS - TR200_18_0	+
WS Max WS - TR200_12_0	✕
WS Max WS - TR200_09_0	•
WS Max WS - TR200_36_0	■
WS Max WS - TR200_06_0	■
WS Max WS - TR200_03_0	✕
WS Max WS - TR200_01_5	▼
WS Max WS - TR200_01_0	▲
WS Max WS - TR200_00_5	■
Ground	■
Levee	□
Bank Sta	•

Studio Scandicci Torrenti Greve-Vingone
River = Fosso Stagnolo Reach = Stagnolo RS = 70 ST0021_C

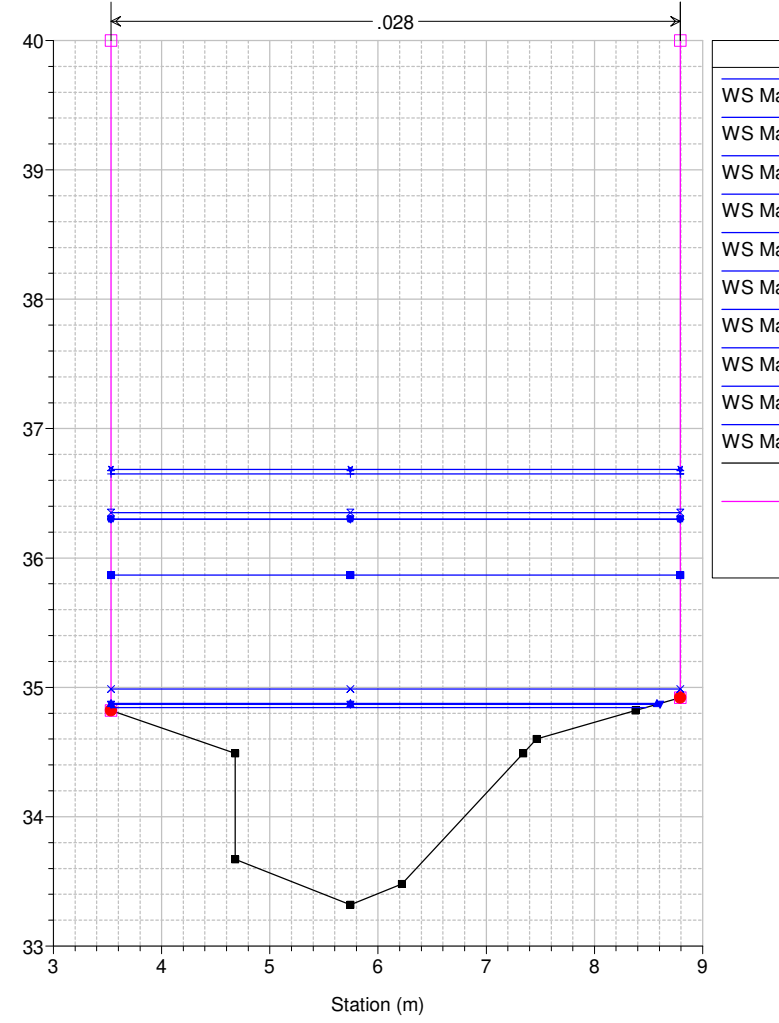

Legend	
WS Max WS - TR200_24_0	✕
WS Max WS - TR200_18_0	+
WS Max WS - TR200_12_0	✕
WS Max WS - TR200_09_0	•
WS Max WS - TR200_36_0	■
WS Max WS - TR200_06_0	■
WS Max WS - TR200_03_0	✕
WS Max WS - TR200_01_5	▼
WS Max WS - TR200_01_0	▲
WS Max WS - TR200_00_5	■
Ground	■
Levee	□
Bank Sta	•

Studio Scandicci Torrenti Greve-Vingone
River = Fosso Stagnolo Reach = Stagnolo RS = 69 ST0021_D

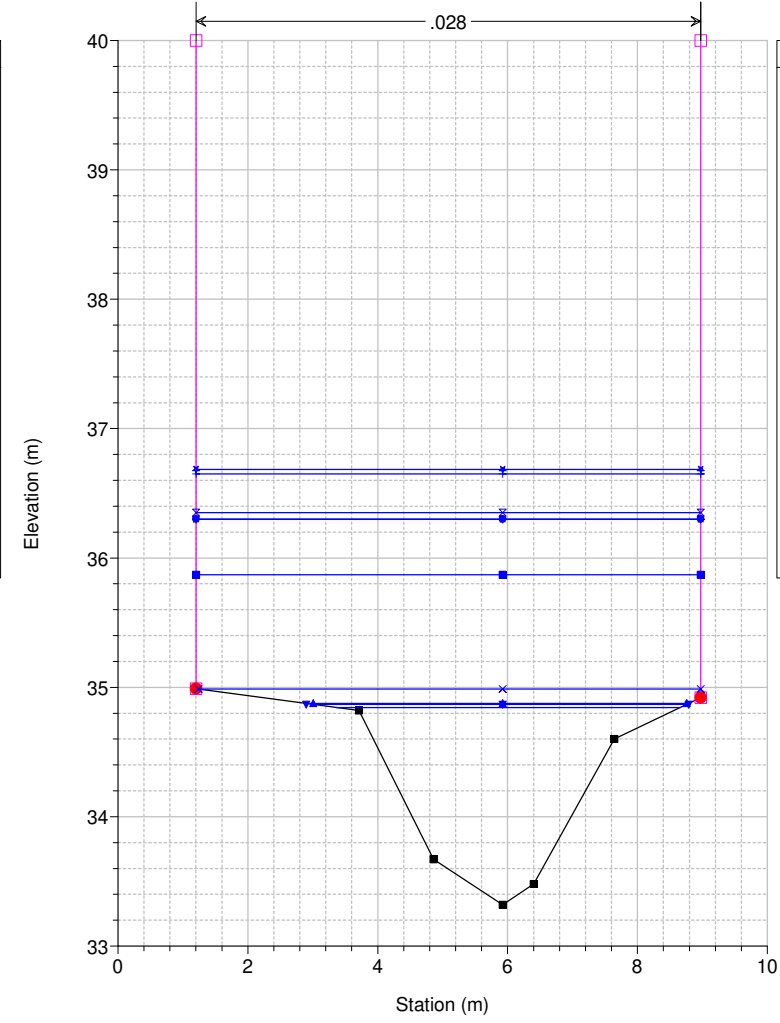

Legend	
WS Max WS - TR200_24_0	✕
WS Max WS - TR200_18_0	+
WS Max WS - TR200_12_0	✕
WS Max WS - TR200_09_0	•
WS Max WS - TR200_36_0	■
WS Max WS - TR200_06_0	■
WS Max WS - TR200_03_0	✕
WS Max WS - TR200_01_5	▼
WS Max WS - TR200_01_0	▲
WS Max WS - TR200_00_5	■
Ground	■
Levee	□
Bank Sta	•

Studio Scandicci Torrenti Greve-Vingone
River = Fosso Stagnolo Reach = Stagnolo RS = 68 ST0022__

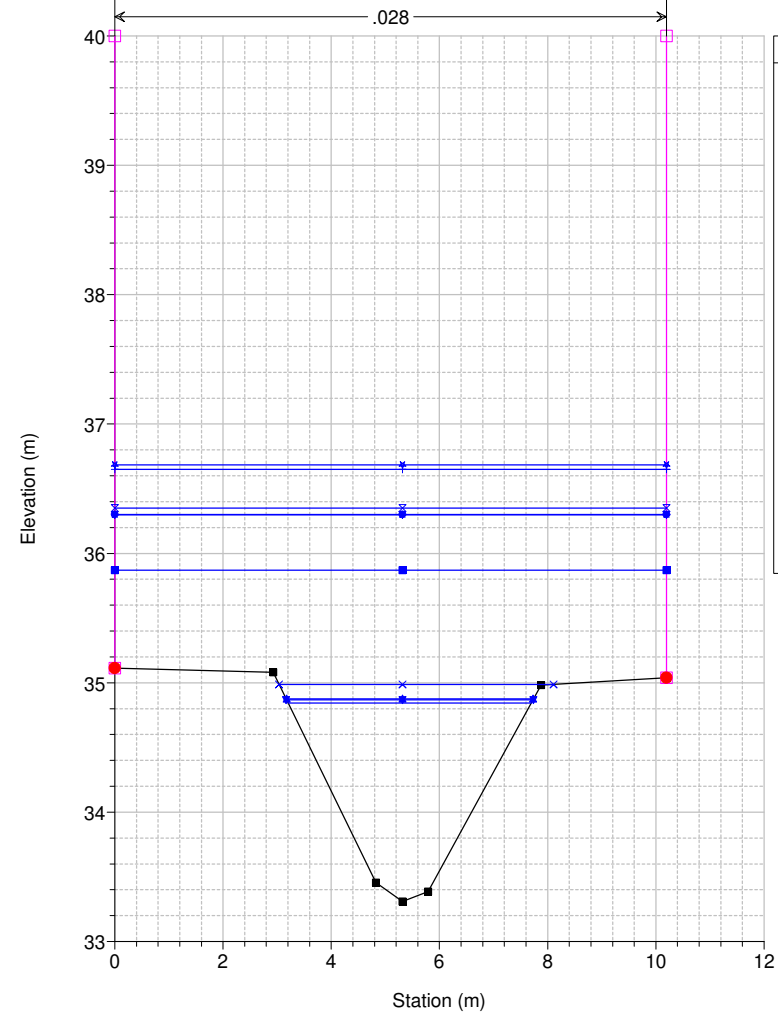

Legend	
WS Max WS - TR200_24_0	✕
WS Max WS - TR200_18_0	+
WS Max WS - TR200_12_0	✕
WS Max WS - TR200_09_0	•
WS Max WS - TR200_36_0	■
WS Max WS - TR200_06_0	■
WS Max WS - TR200_03_0	✕
WS Max WS - TR200_01_5	▼
WS Max WS - TR200_01_0	▲
WS Max WS - TR200_00_5	■
Ground	■
Levee	□
Bank Sta	•

Studio Scandicci Torrenti Greve-Vingone
River = Fosso Stagnolo Reach = Stagnolo RS = 67 ST0023__

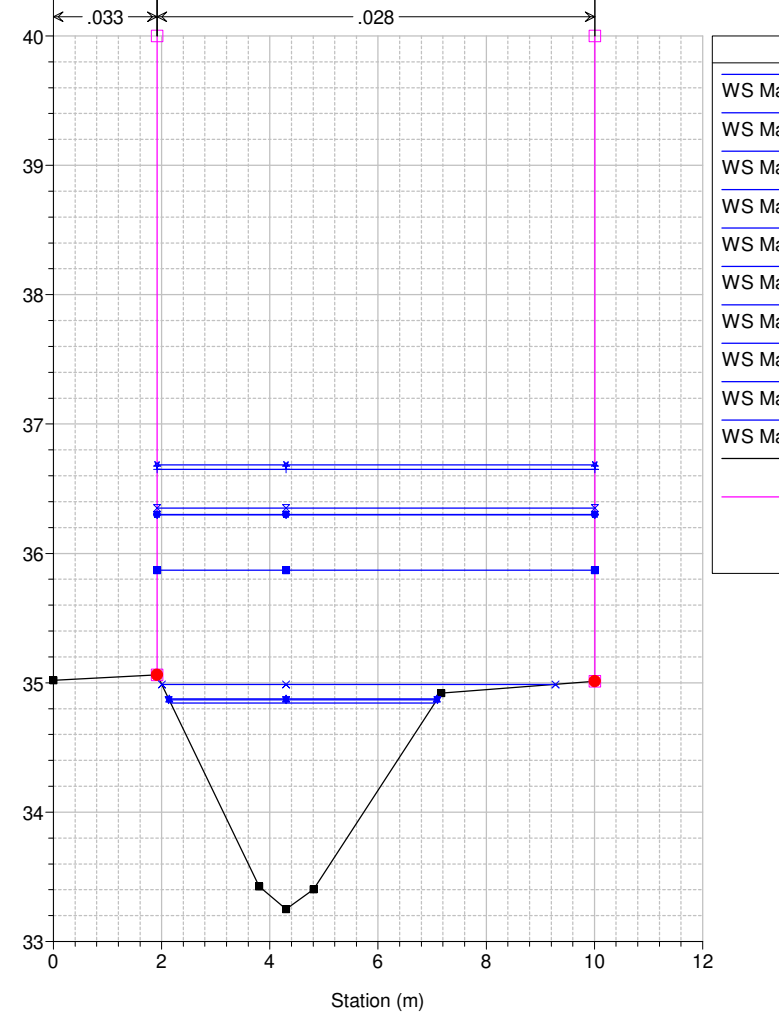

Legend	
WS Max WS - TR200_24_0	✕
WS Max WS - TR200_18_0	+
WS Max WS - TR200_12_0	✕
WS Max WS - TR200_09_0	•
WS Max WS - TR200_36_0	■
WS Max WS - TR200_06_0	■
WS Max WS - TR200_03_0	✕
WS Max WS - TR200_01_5	▼
WS Max WS - TR200_01_0	▲
WS Max WS - TR200_00_5	■
Ground	■
Levee	□
Bank Sta	•

Studio Scandicci Torrenti Greve-Vingone
River = Fosso Stagnolo Reach = Stagnolo RS = 66 ST0024__

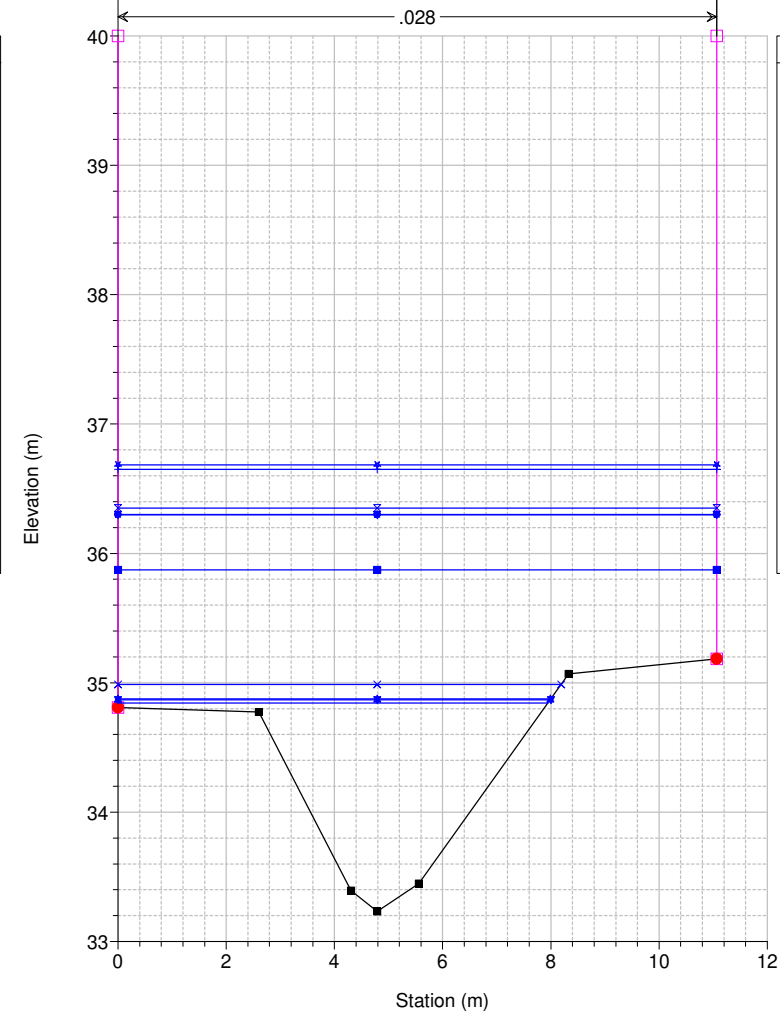

Legend	
WS Max WS - TR200_24_0	✕
WS Max WS - TR200_18_0	+
WS Max WS - TR200_12_0	✕
WS Max WS - TR200_09_0	•
WS Max WS - TR200_36_0	■
WS Max WS - TR200_06_0	■
WS Max WS - TR200_03_0	✕
WS Max WS - TR200_01_5	▼
WS Max WS - TR200_01_0	▲
WS Max WS - TR200_00_5	■
Ground	■
Levee	□
Bank Sta	•

Studio Scandicci Torrenti Greve-Vingone
River = Fosso Stagnolo Reach = Stagnolo RS = 65 ST0025_

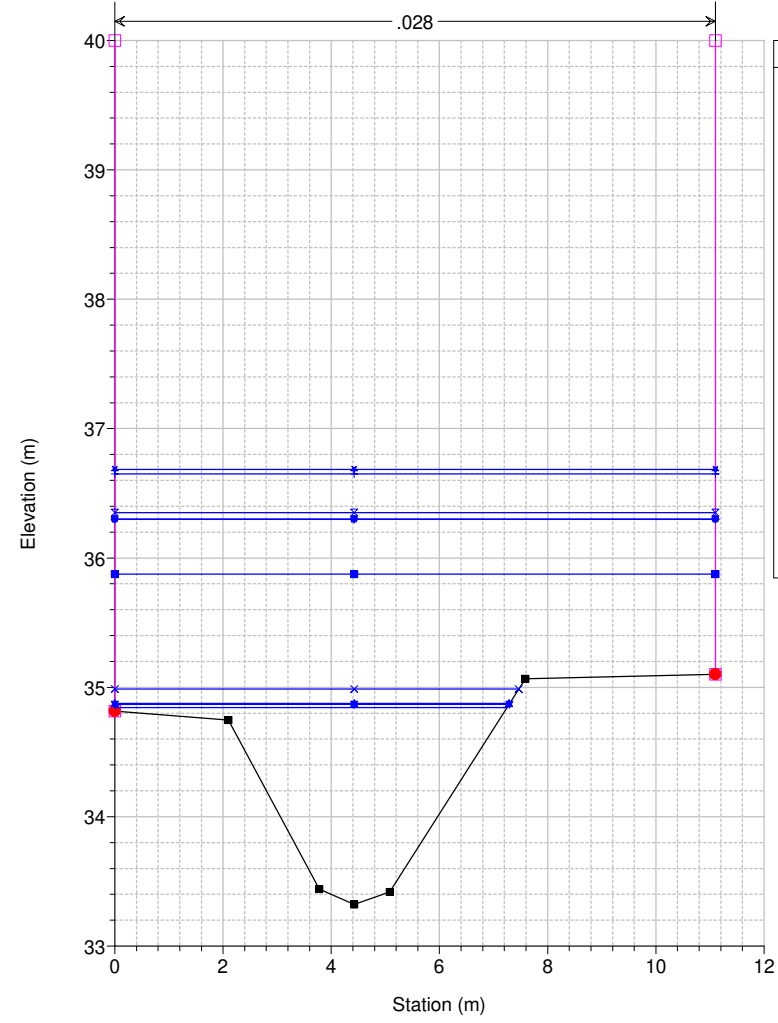

Legend

- WS Max WS - TR200_24_0
- WS Max WS - TR200_18_0
- WS Max WS - TR200_12_0
- WS Max WS - TR200_09_0
- WS Max WS - TR200_36_0
- WS Max WS - TR200_06_0
- WS Max WS - TR200_03_0
- WS Max WS - TR200_01_5
- WS Max WS - TR200_01_0
- WS Max WS - TR200_00_5
- Ground
- Levee
- Bank Sta

Studio Scandicci Torrenti Greve-Vingone
River = Fosso Stagnolo Reach = Stagnolo RS = 64 ST0026_

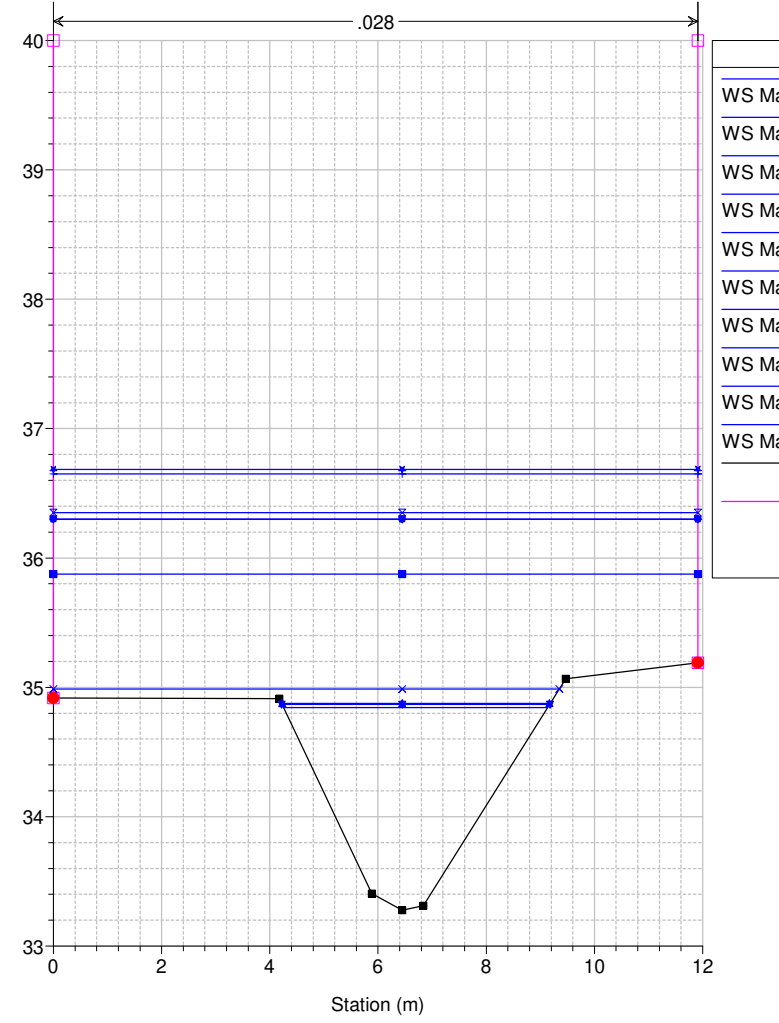

Legend

- WS Max WS - TR200_24_0
- WS Max WS - TR200_18_0
- WS Max WS - TR200_12_0
- WS Max WS - TR200_09_0
- WS Max WS - TR200_36_0
- WS Max WS - TR200_06_0
- WS Max WS - TR200_03_0
- WS Max WS - TR200_01_5
- WS Max WS - TR200_01_0
- WS Max WS - TR200_00_5
- Ground
- Levee
- Bank Sta

Studio Scandicci Torrenti Greve-Vingone
River = Fosso Stagnolo Reach = Stagnolo RS = 63 ST0027_A

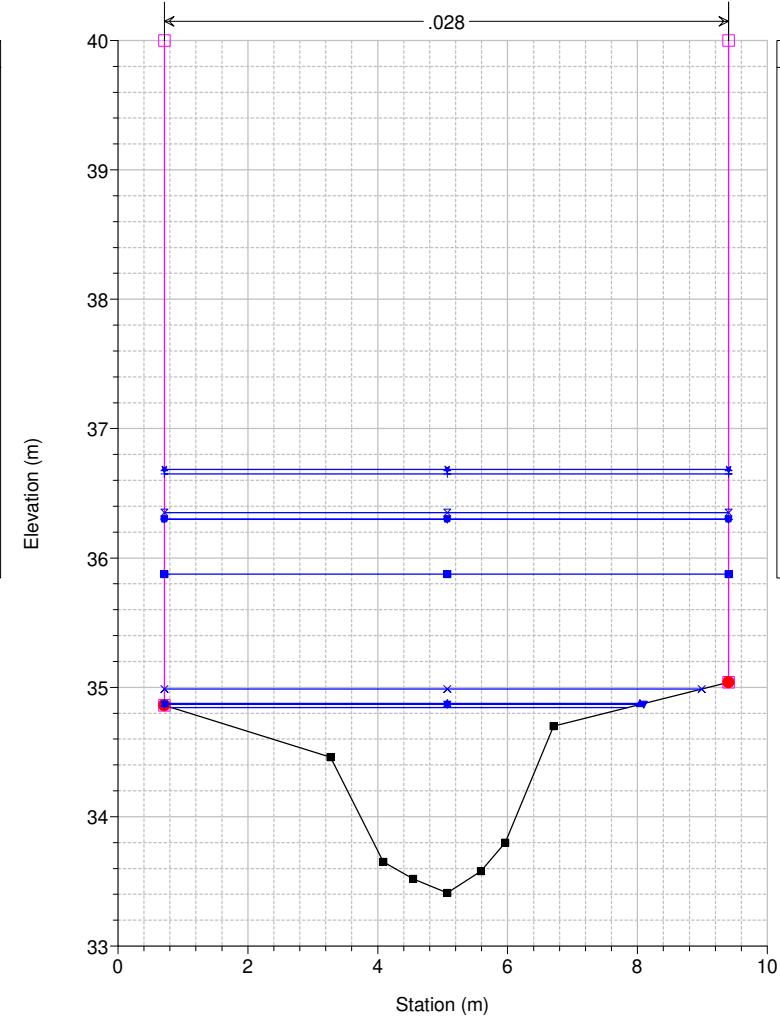

Legend

- WS Max WS - TR200_24_0
- WS Max WS - TR200_18_0
- WS Max WS - TR200_12_0
- WS Max WS - TR200_09_0
- WS Max WS - TR200_36_0
- WS Max WS - TR200_06_0
- WS Max WS - TR200_03_0
- WS Max WS - TR200_01_5
- WS Max WS - TR200_01_0
- WS Max WS - TR200_00_5
- Ground
- Levee
- Bank Sta

Studio Scandicci Torrenti Greve-Vingone
River = Fosso Stagnolo Reach = Stagnolo RS = 62 ST0027_B

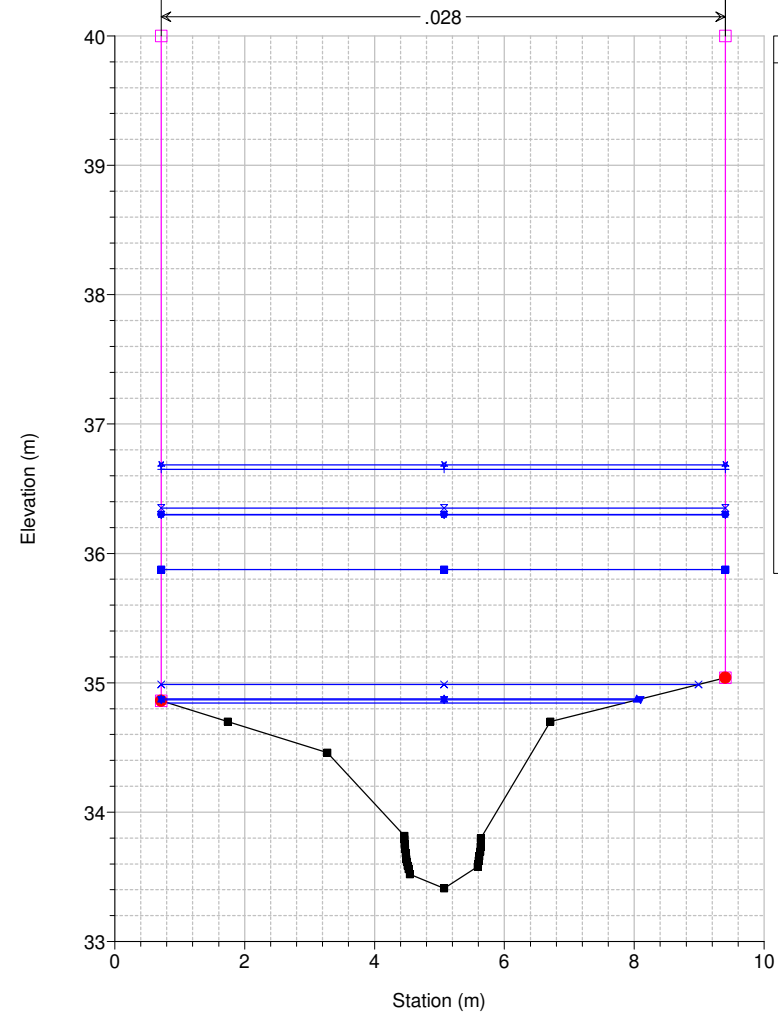

Legend

- WS Max WS - TR200_24_0
- WS Max WS - TR200_18_0
- WS Max WS - TR200_12_0
- WS Max WS - TR200_09_0
- WS Max WS - TR200_36_0
- WS Max WS - TR200_06_0
- WS Max WS - TR200_03_0
- WS Max WS - TR200_01_5
- WS Max WS - TR200_01_0
- WS Max WS - TR200_00_5
- Ground
- Levee
- Bank Sta

Studio Scandicci Torrenti Greve-Vingone
River = Fosso Stagnolo Reach = Stagnolo RS = 61.5 BR

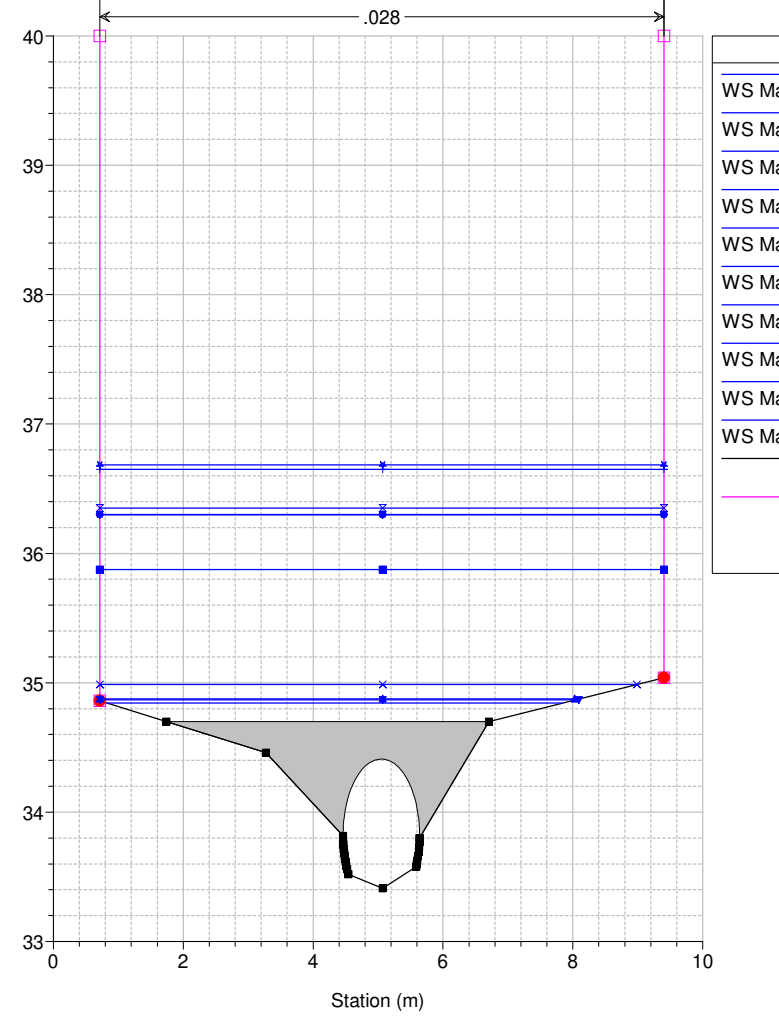

Legend

- WS Max WS - TR200_24_0
- WS Max WS - TR200_18_0
- WS Max WS - TR200_12_0
- WS Max WS - TR200_09_0
- WS Max WS - TR200_36_0
- WS Max WS - TR200_06_0
- WS Max WS - TR200_03_0
- WS Max WS - TR200_01_5
- WS Max WS - TR200_01_0
- WS Max WS - TR200_00_5
- Ground
- Levee
- Bank Sta

Studio Scandicci Torrenti Greve-Vingone
River = Fosso Stagnolo Reach = Stagnolo RS = 61.5 BR

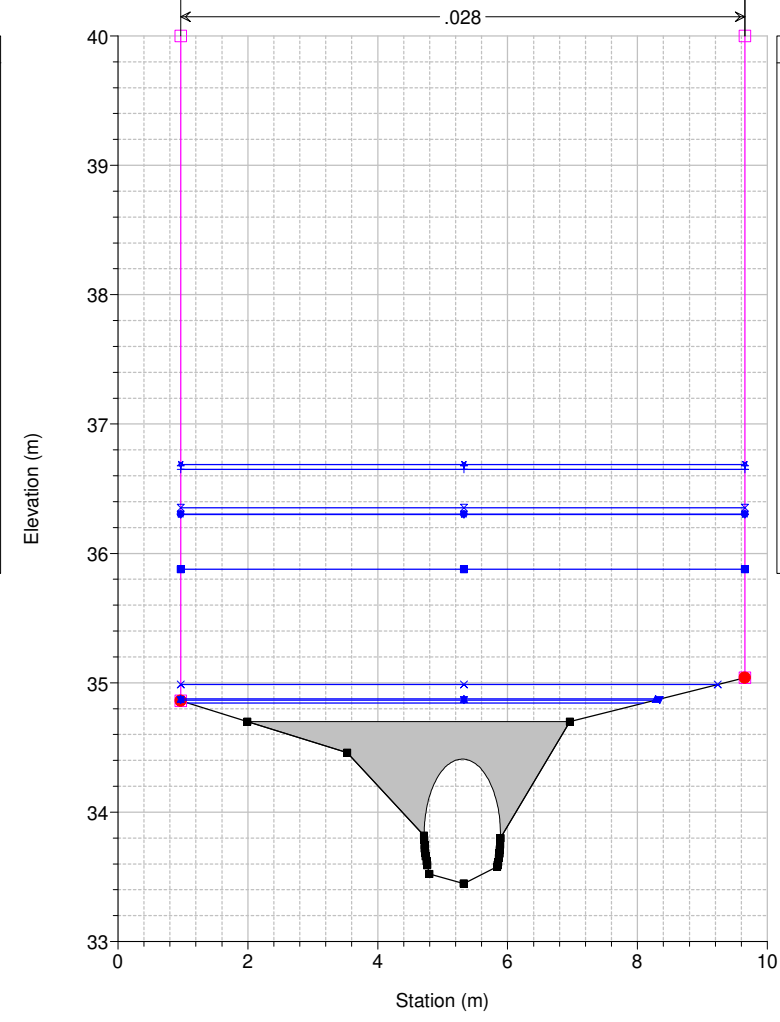

Legend

- WS Max WS - TR200_24_0
- WS Max WS - TR200_18_0
- WS Max WS - TR200_12_0
- WS Max WS - TR200_09_0
- WS Max WS - TR200_36_0
- WS Max WS - TR200_06_0
- WS Max WS - TR200_03_0
- WS Max WS - TR200_01_5
- WS Max WS - TR200_01_0
- WS Max WS - TR200_00_5
- Ground
- Levee
- Bank Sta

Studio Scandicci Torrenti Greve-Vingone
River = Fosso Stagnolo Reach = Stagnolo RS = 61 ST0027_C

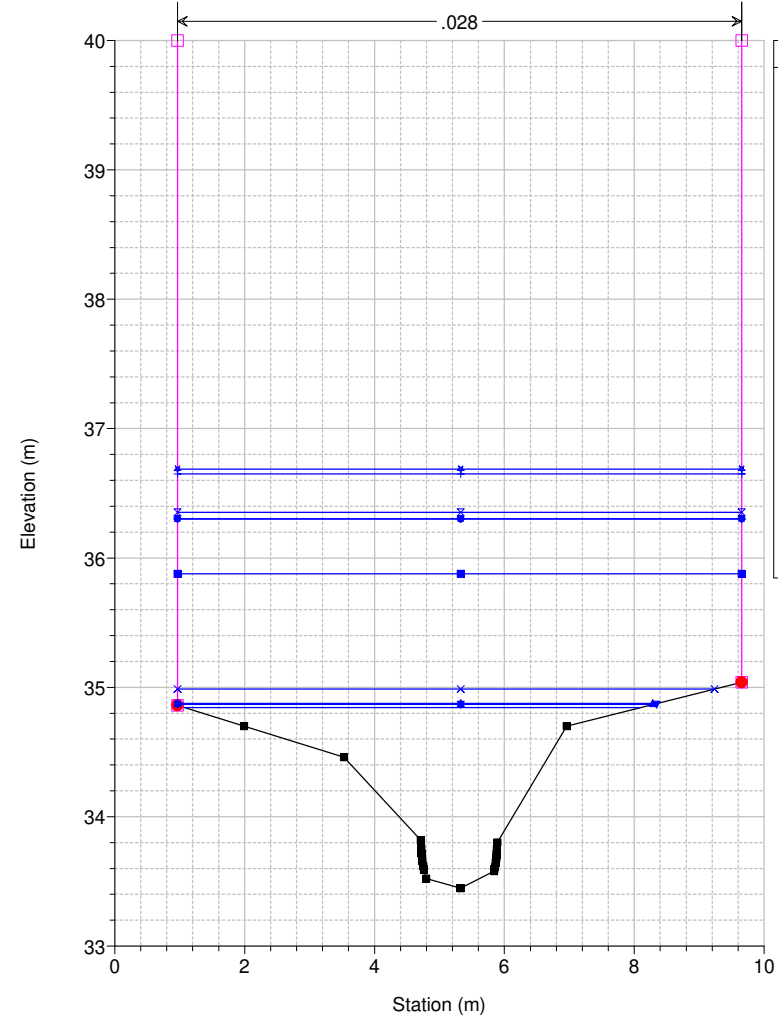

Legend	
WS Max WS - TR200_24_0	✕
WS Max WS - TR200_18_0	+
WS Max WS - TR200_12_0	✕
WS Max WS - TR200_09_0	•
WS Max WS - TR200_36_0	■
WS Max WS - TR200_06_0	■
WS Max WS - TR200_03_0	✕
WS Max WS - TR200_01_5	▼
WS Max WS - TR200_01_0	▲
WS Max WS - TR200_00_5	■
Ground	■
Levee	□
Bank Sta	•

Studio Scandicci Torrenti Greve-Vingone
River = Fosso Stagnolo Reach = Stagnolo RS = 60 ST0027_D

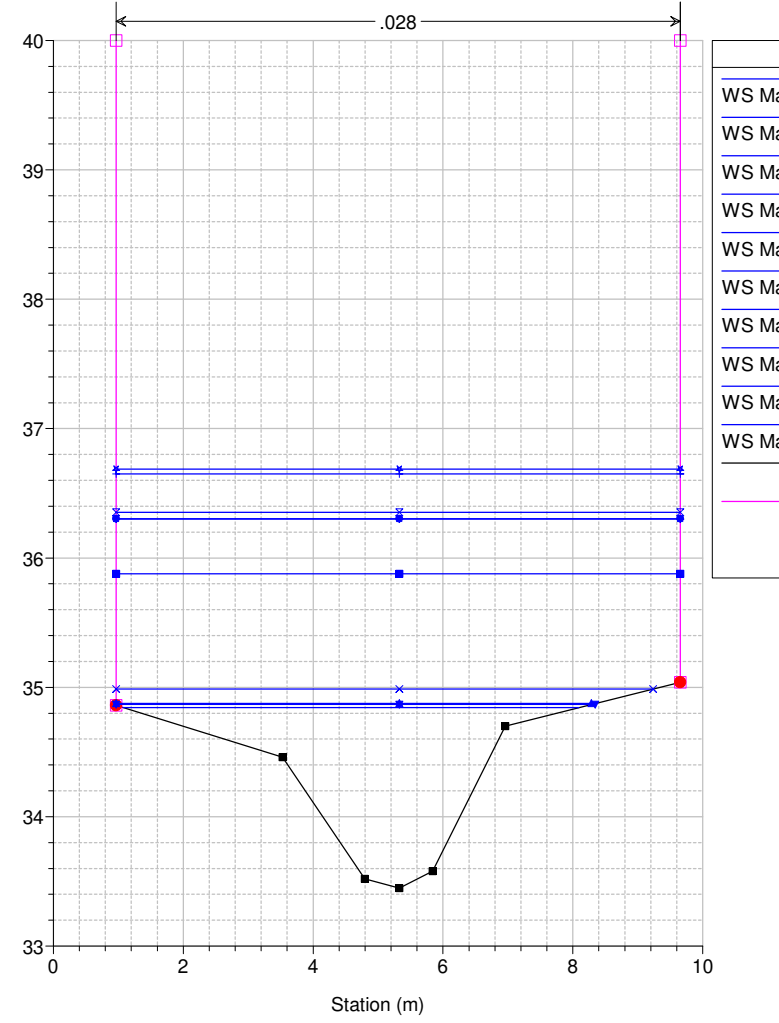

Legend	
WS Max WS - TR200_24_0	✕
WS Max WS - TR200_18_0	+
WS Max WS - TR200_12_0	✕
WS Max WS - TR200_09_0	•
WS Max WS - TR200_36_0	■
WS Max WS - TR200_06_0	■
WS Max WS - TR200_03_0	✕
WS Max WS - TR200_01_5	▼
WS Max WS - TR200_01_0	▲
WS Max WS - TR200_00_5	■
Ground	■
Levee	□
Bank Sta	•

Studio Scandicci Torrenti Greve-Vingone
River = Fosso Stagnolo Reach = Stagnolo RS = 59 ST0028__

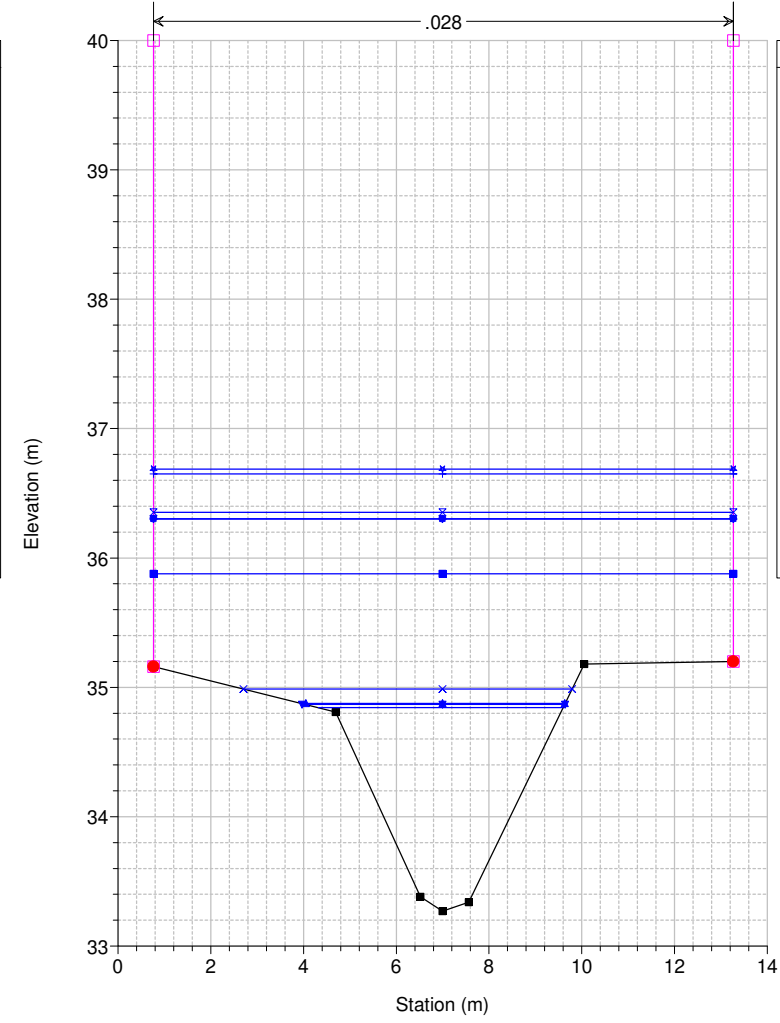

Legend	
WS Max WS - TR200_24_0	✕
WS Max WS - TR200_18_0	+
WS Max WS - TR200_12_0	✕
WS Max WS - TR200_09_0	•
WS Max WS - TR200_36_0	■
WS Max WS - TR200_06_0	■
WS Max WS - TR200_03_0	✕
WS Max WS - TR200_01_5	▼
WS Max WS - TR200_01_0	▲
WS Max WS - TR200_00_5	■
Ground	■
Levee	□
Bank Sta	•

Studio Scandicci Torrenti Greve-Vingone
River = Fosso Stagnolo Reach = Stagnolo RS = 58 ST0029__

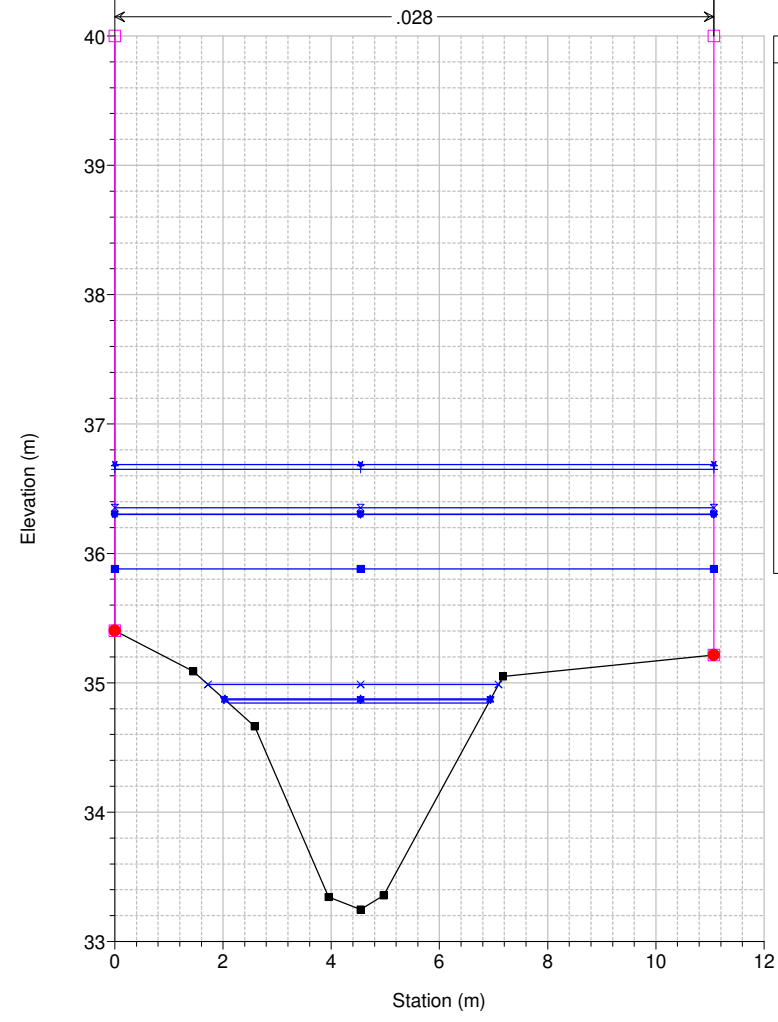

Legend	
WS Max WS - TR200_24_0	✕
WS Max WS - TR200_18_0	+
WS Max WS - TR200_12_0	✕
WS Max WS - TR200_09_0	•
WS Max WS - TR200_36_0	■
WS Max WS - TR200_06_0	■
WS Max WS - TR200_03_0	✕
WS Max WS - TR200_01_5	▼
WS Max WS - TR200_01_0	▲
WS Max WS - TR200_00_5	■
Ground	■
Levee	□
Bank Sta	•

Studio Scandicci Torrenti Greve-Vingone
River = Fosso Stagnolo Reach = Stagnolo RS = 57 ST0030__

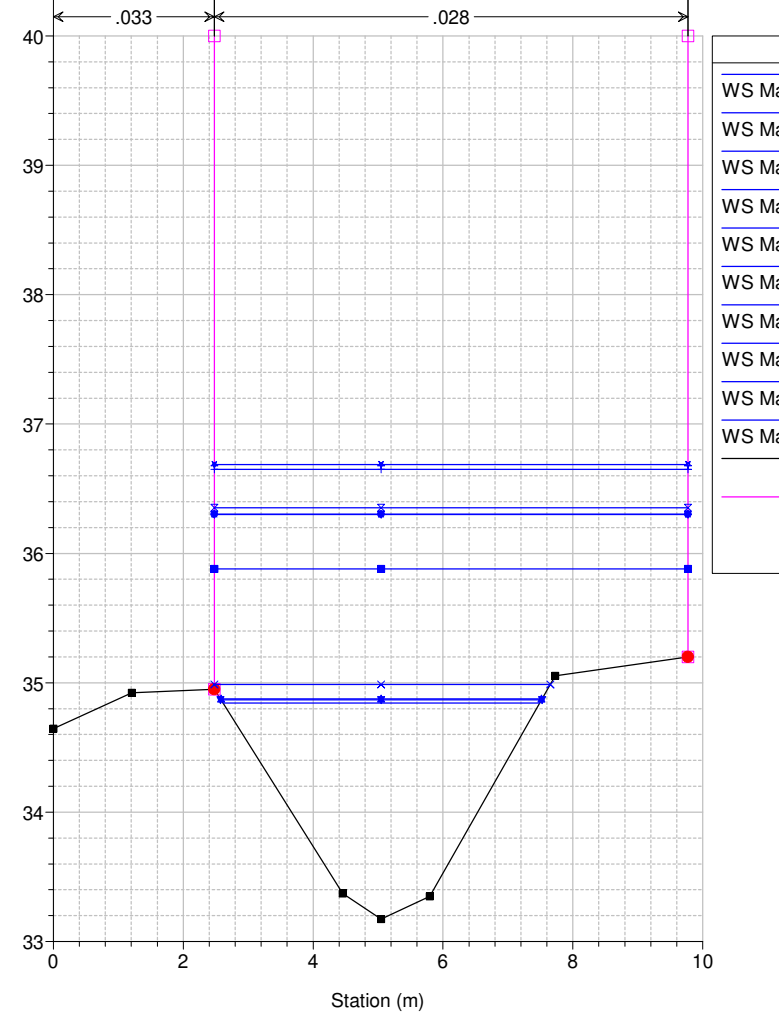

Legend	
WS Max WS - TR200_24_0	✕
WS Max WS - TR200_18_0	+
WS Max WS - TR200_12_0	✕
WS Max WS - TR200_09_0	•
WS Max WS - TR200_36_0	■
WS Max WS - TR200_06_0	■
WS Max WS - TR200_03_0	✕
WS Max WS - TR200_01_5	▼
WS Max WS - TR200_01_0	▲
WS Max WS - TR200_00_5	■
Ground	■
Levee	□
Bank Sta	•

Studio Scandicci Torrenti Greve-Vingone
River = Fosso Stagnolo Reach = Stagnolo RS = 56 ST0031__

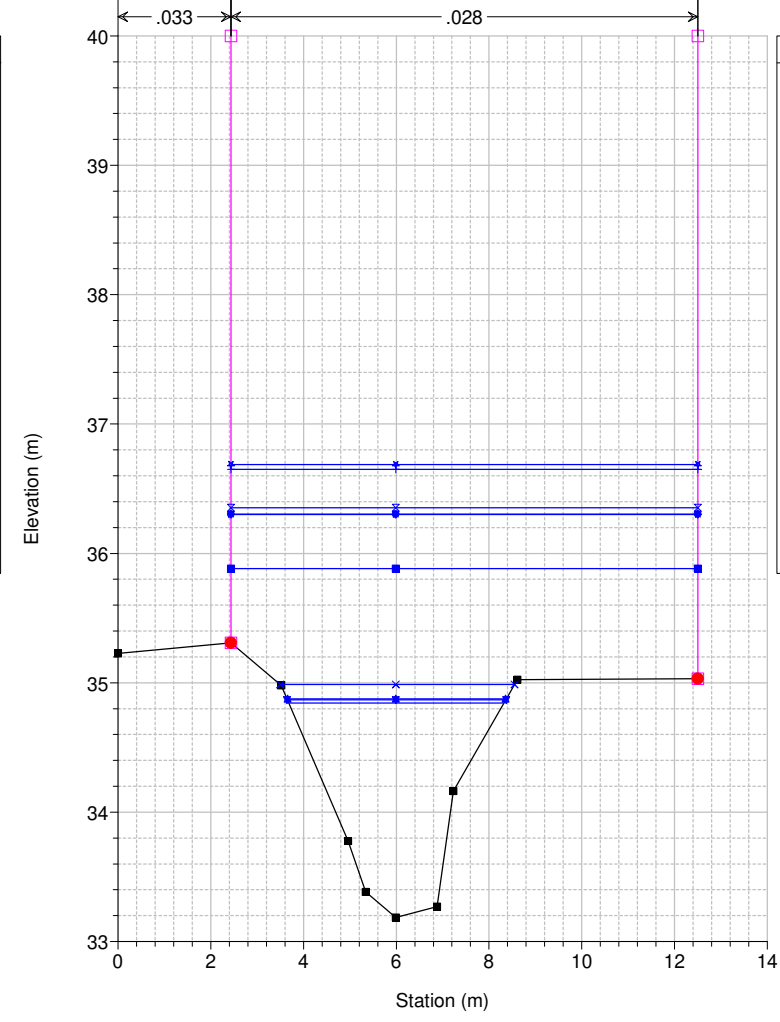

Legend	
WS Max WS - TR200_24_0	✕
WS Max WS - TR200_18_0	+
WS Max WS - TR200_12_0	✕
WS Max WS - TR200_09_0	•
WS Max WS - TR200_36_0	■
WS Max WS - TR200_06_0	■
WS Max WS - TR200_03_0	✕
WS Max WS - TR200_01_5	▼
WS Max WS - TR200_01_0	▲
WS Max WS - TR200_00_5	■
Ground	■
Levee	□
Bank Sta	•

Studio Scandicci Torrenti Greve-Vingone
River = Fosso Stagnolo Reach = Stagnolo RS = 55 ST0032_

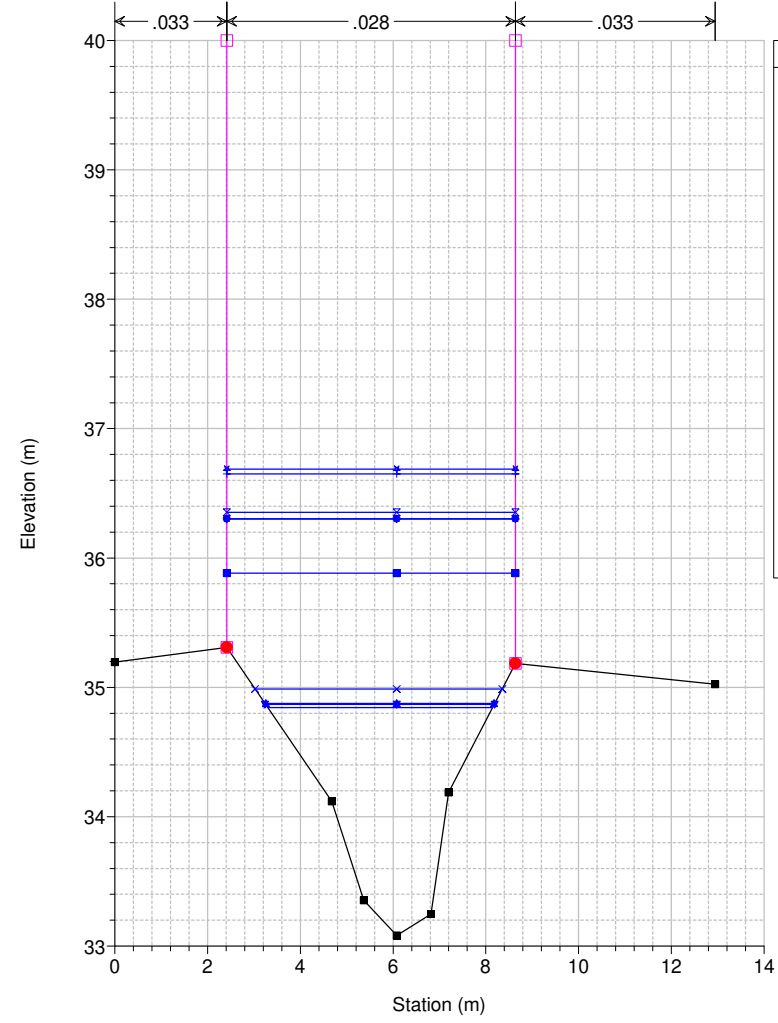

Legend

- WS Max WS - TR200_24_0
- WS Max WS - TR200_18_0
- WS Max WS - TR200_12_0
- WS Max WS - TR200_09_0
- WS Max WS - TR200_36_0
- WS Max WS - TR200_06_0
- WS Max WS - TR200_03_0
- WS Max WS - TR200_01_5
- WS Max WS - TR200_01_0
- WS Max WS - TR200_00_5
- Ground
- Levee
- Bank Sta

Studio Scandicci Torrenti Greve-Vingone
River = Fosso Stagnolo Reach = Stagnolo RS = 54 ST0033_

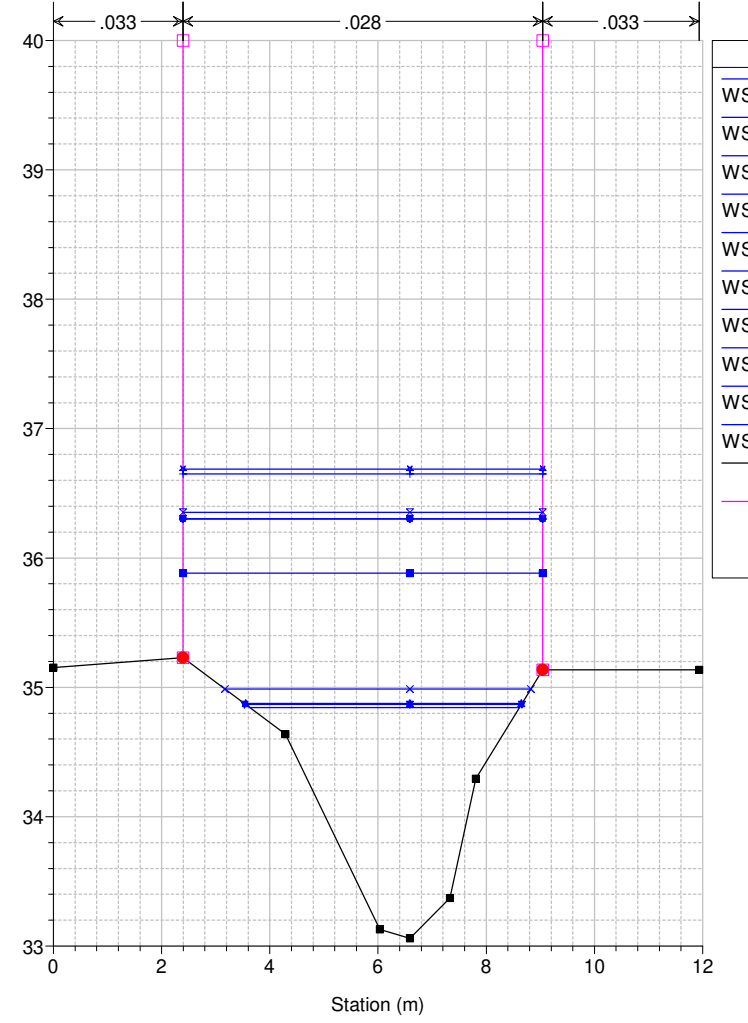

Legend

- WS Max WS - TR200_24_0
- WS Max WS - TR200_18_0
- WS Max WS - TR200_12_0
- WS Max WS - TR200_09_0
- WS Max WS - TR200_36_0
- WS Max WS - TR200_06_0
- WS Max WS - TR200_03_0
- WS Max WS - TR200_01_5
- WS Max WS - TR200_01_0
- WS Max WS - TR200_00_5
- Ground
- Levee
- Bank Sta

Studio Scandicci Torrenti Greve-Vingone
River = Fosso Stagnolo Reach = Stagnolo RS = 53 ST0034_

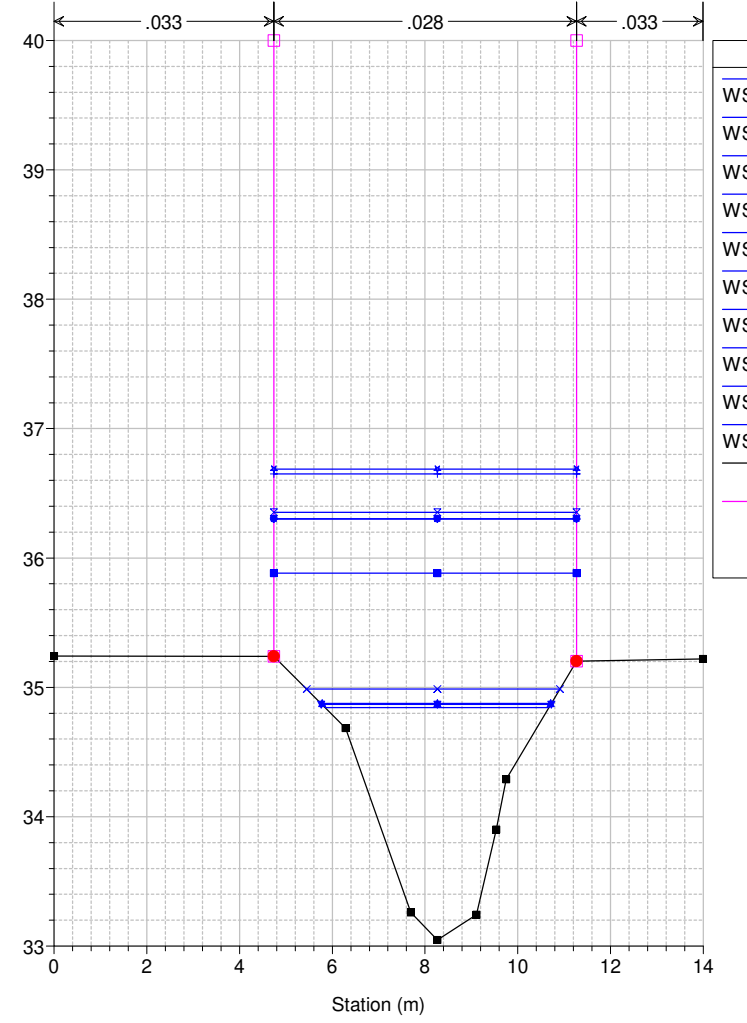

Legend

- WS Max WS - TR200_24_0
- WS Max WS - TR200_18_0
- WS Max WS - TR200_12_0
- WS Max WS - TR200_09_0
- WS Max WS - TR200_36_0
- WS Max WS - TR200_06_0
- WS Max WS - TR200_03_0
- WS Max WS - TR200_01_5
- WS Max WS - TR200_01_0
- WS Max WS - TR200_00_5
- Ground
- Levee
- Bank Sta

Studio Scandicci Torrenti Greve-Vingone
River = Fosso Stagnolo Reach = Stagnolo RS = 52 ST0035_

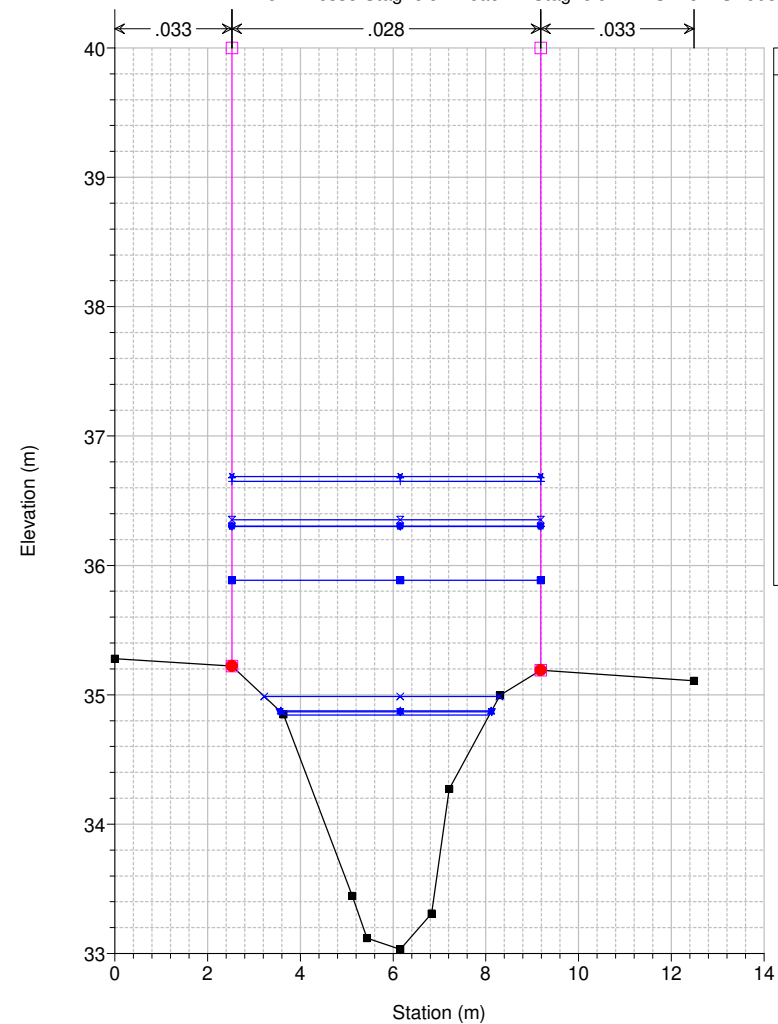

Legend

- WS Max WS - TR200_24_0
- WS Max WS - TR200_18_0
- WS Max WS - TR200_12_0
- WS Max WS - TR200_09_0
- WS Max WS - TR200_36_0
- WS Max WS - TR200_06_0
- WS Max WS - TR200_03_0
- WS Max WS - TR200_01_5
- WS Max WS - TR200_01_0
- WS Max WS - TR200_00_5
- Ground
- Levee
- Bank Sta

Studio Scandicci Torrenti Greve-Vingone
River = Fosso Stagnolo Reach = Stagnolo RS = 51 ST0036_

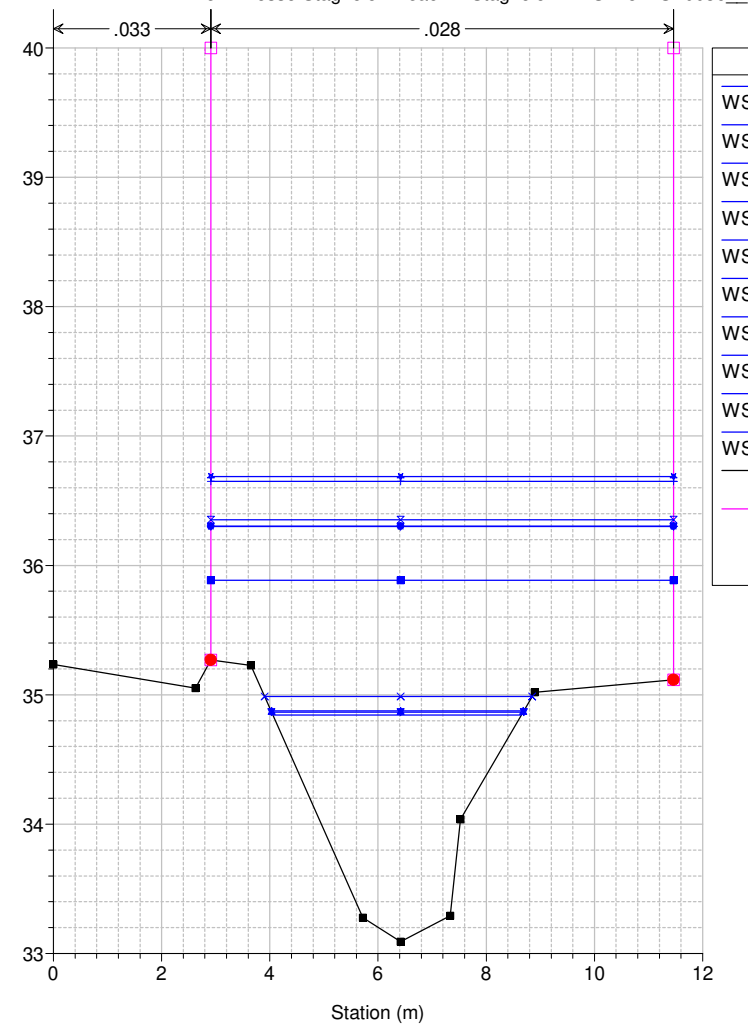

Legend

- WS Max WS - TR200_24_0
- WS Max WS - TR200_18_0
- WS Max WS - TR200_12_0
- WS Max WS - TR200_09_0
- WS Max WS - TR200_36_0
- WS Max WS - TR200_06_0
- WS Max WS - TR200_03_0
- WS Max WS - TR200_01_5
- WS Max WS - TR200_01_0
- WS Max WS - TR200_00_5
- Ground
- Levee
- Bank Sta

Studio Scandicci Torrenti Greve-Vingone
River = Fosso Stagnolo Reach = Stagnolo RS = 50 ST0037_A

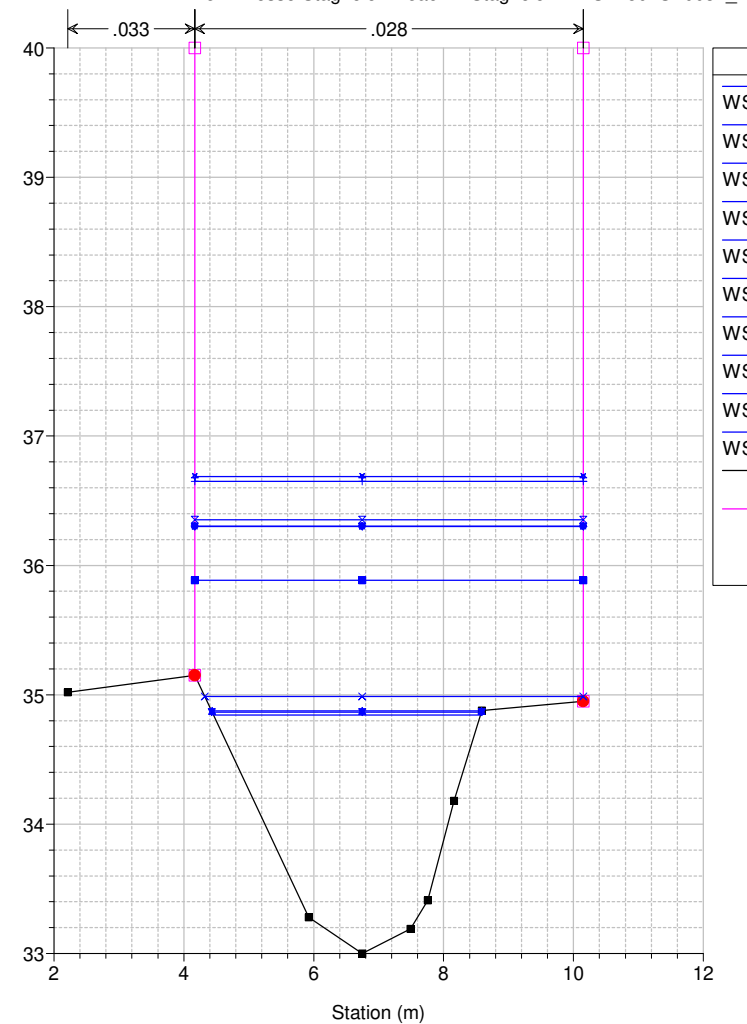

Legend

- WS Max WS - TR200_24_0
- WS Max WS - TR200_18_0
- WS Max WS - TR200_12_0
- WS Max WS - TR200_09_0
- WS Max WS - TR200_36_0
- WS Max WS - TR200_06_0
- WS Max WS - TR200_03_0
- WS Max WS - TR200_01_5
- WS Max WS - TR200_01_0
- WS Max WS - TR200_00_5
- Ground
- Levee
- Bank Sta

Studio Scandicci Torrenti Greve-Vingone
River = Fosso Stagnolo Reach = Stagnolo RS = 49 ST0037_B

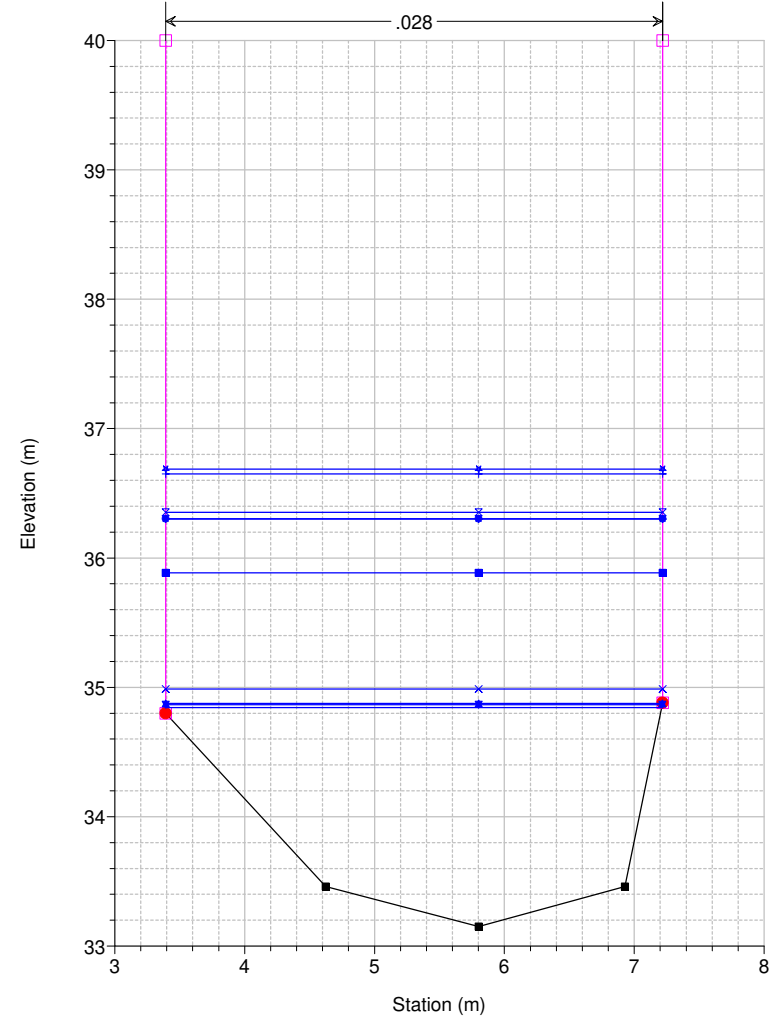

Studio Scandicci Torrenti Greve-Vingone
River = Fosso Stagnolo Reach = Stagnolo RS = 48.5 BR

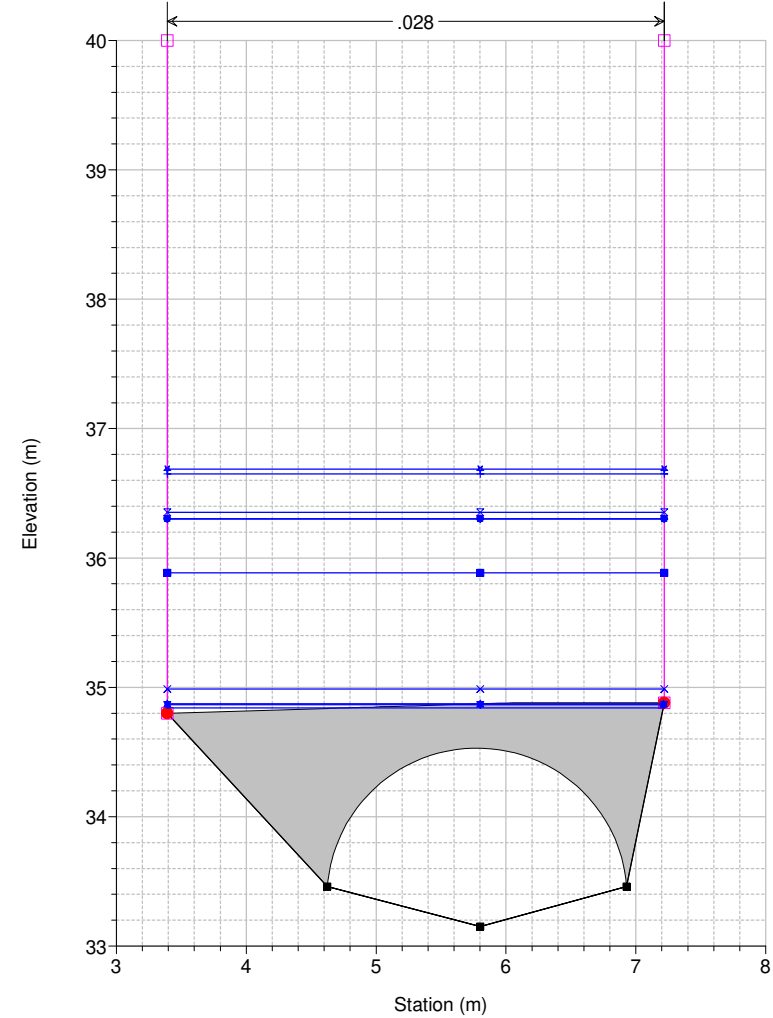

Studio Scandicci Torrenti Greve-Vingone
River = Fosso Stagnolo Reach = Stagnolo RS = 48.5 BR

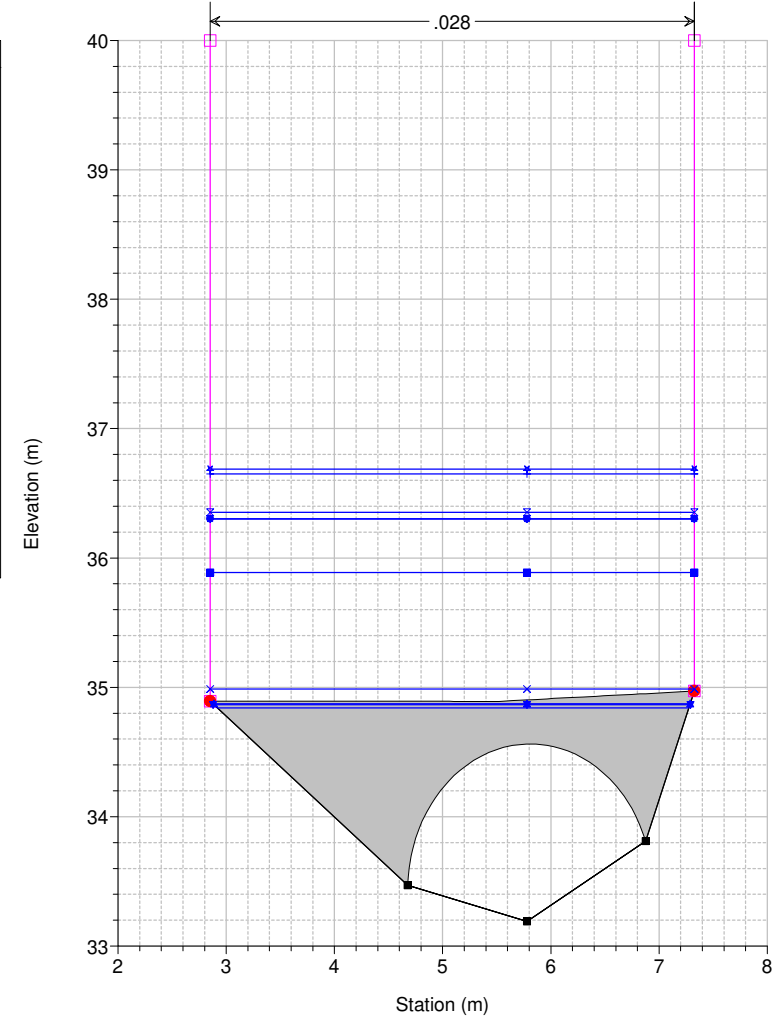

Studio Scandicci Torrenti Greve-Vingone
River = Fosso Stagnolo Reach = Stagnolo RS = 48 ST0037_C

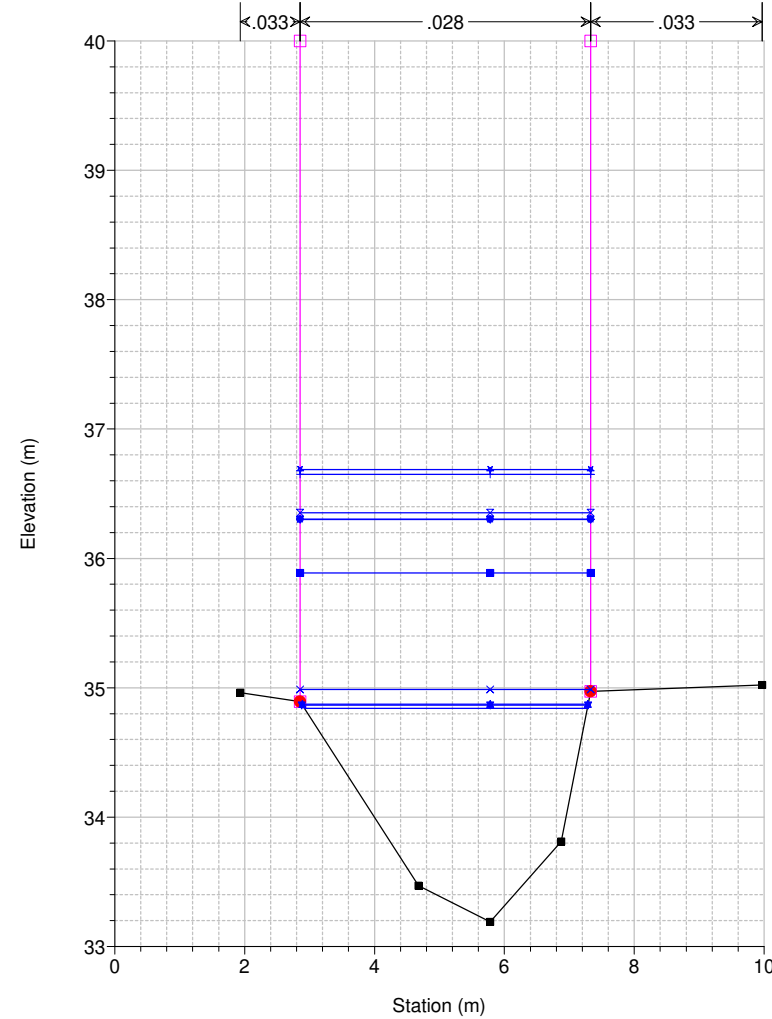

Studio Scandicci Torrenti Greve-Vingone
River = Fosso Stagnolo Reach = Stagnolo RS = 47 ST0037_D

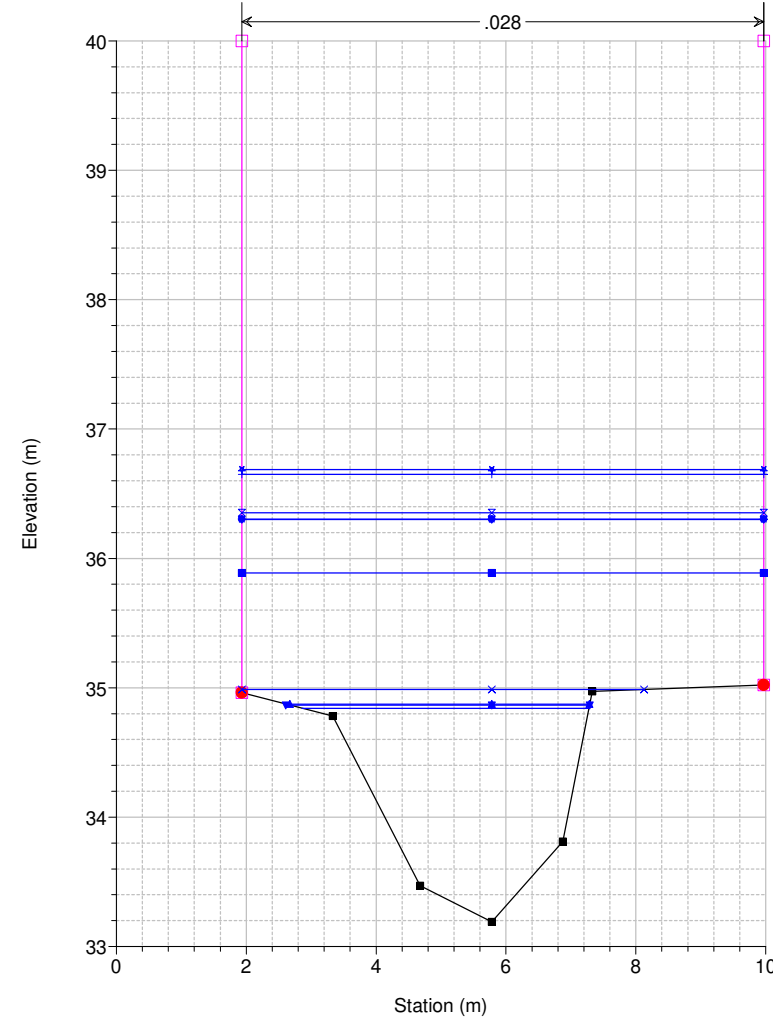

Studio Scandicci Torrenti Greve-Vingone
River = Fosso Stagnolo Reach = Stagnolo RS = 46 ST0038_

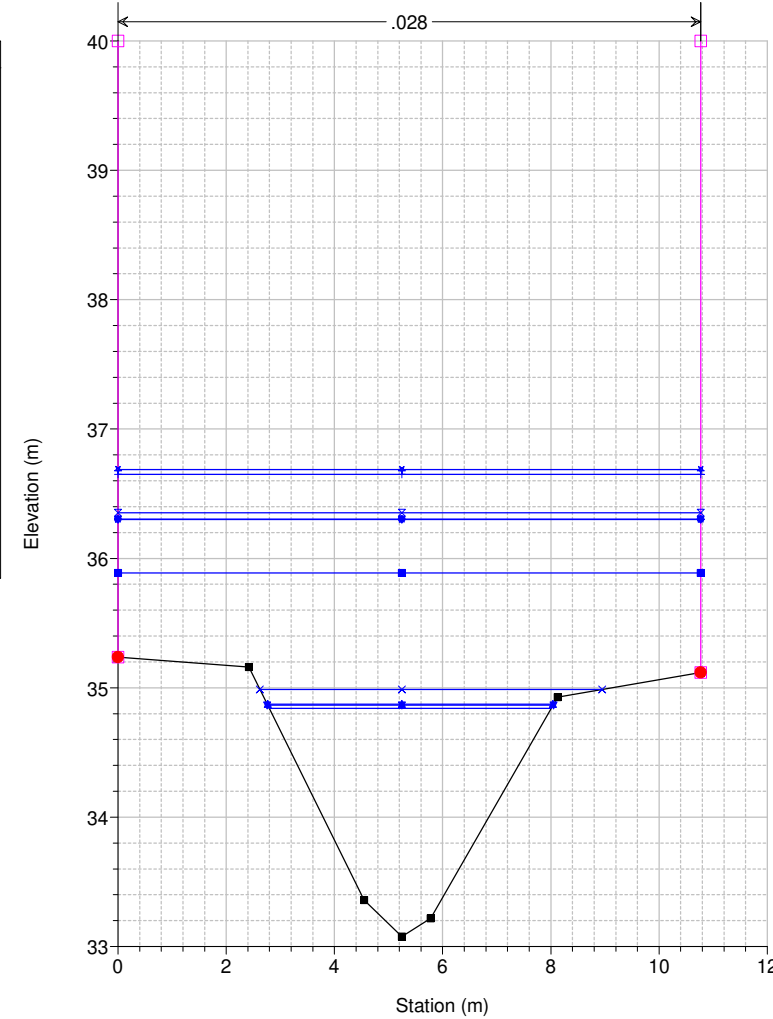

Studio Scandicci Torrenti Greve-Vingone
River = Fosso Stagnolo Reach = Stagnolo RS = 45 ST0039__

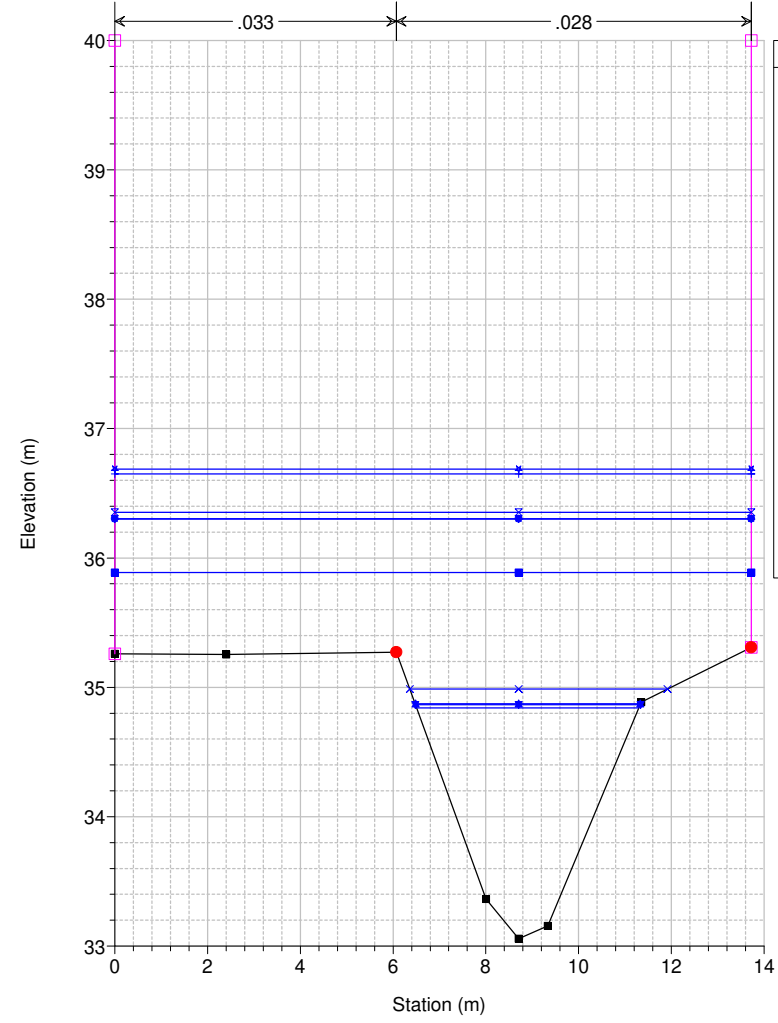

Legend

- WS Max WS - TR200_24_0
- WS Max WS - TR200_18_0
- WS Max WS - TR200_12_0
- WS Max WS - TR200_09_0
- WS Max WS - TR200_36_0
- WS Max WS - TR200_06_0
- WS Max WS - TR200_03_0
- WS Max WS - TR200_01_5
- WS Max WS - TR200_01_0
- WS Max WS - TR200_00_5
- Ground
- Levee
- Bank Sta

Studio Scandicci Torrenti Greve-Vingone
River = Fosso Stagnolo Reach = Stagnolo RS = 44 ST0040__

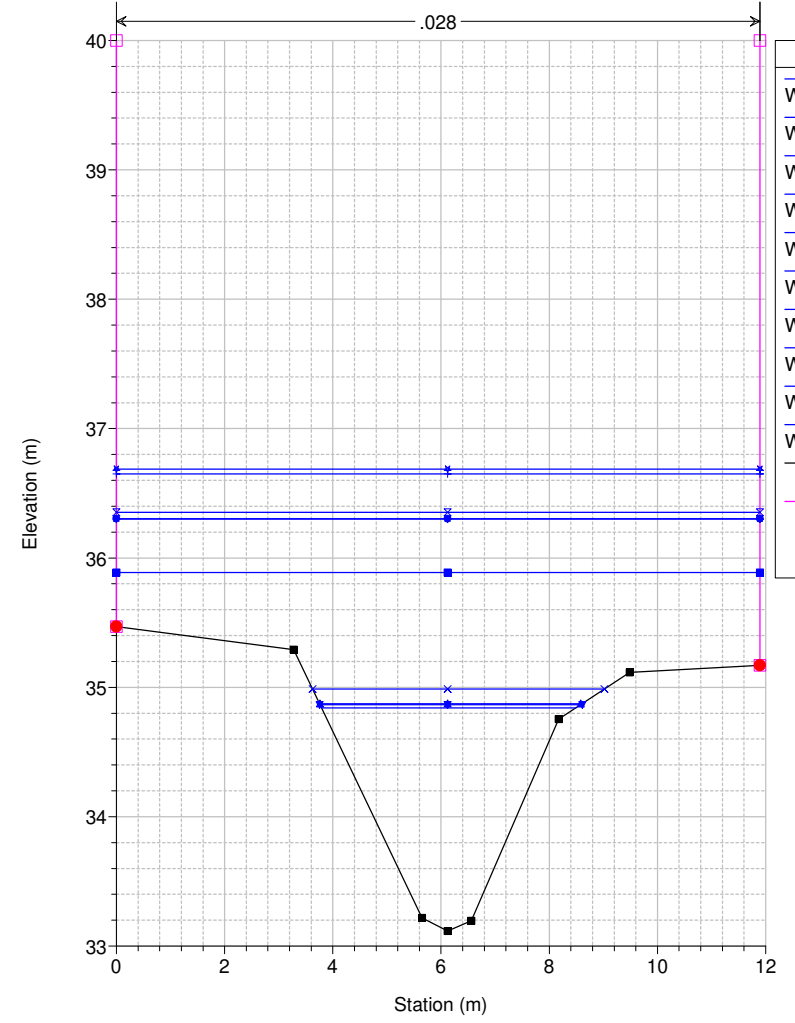

Legend

- WS Max WS - TR200_24_0
- WS Max WS - TR200_18_0
- WS Max WS - TR200_12_0
- WS Max WS - TR200_09_0
- WS Max WS - TR200_36_0
- WS Max WS - TR200_06_0
- WS Max WS - TR200_03_0
- WS Max WS - TR200_01_5
- WS Max WS - TR200_01_0
- WS Max WS - TR200_00_5
- Ground
- Levee
- Bank Sta

Studio Scandicci Torrenti Greve-Vingone
River = Fosso Stagnolo Reach = Stagnolo RS = 43 ST0041__

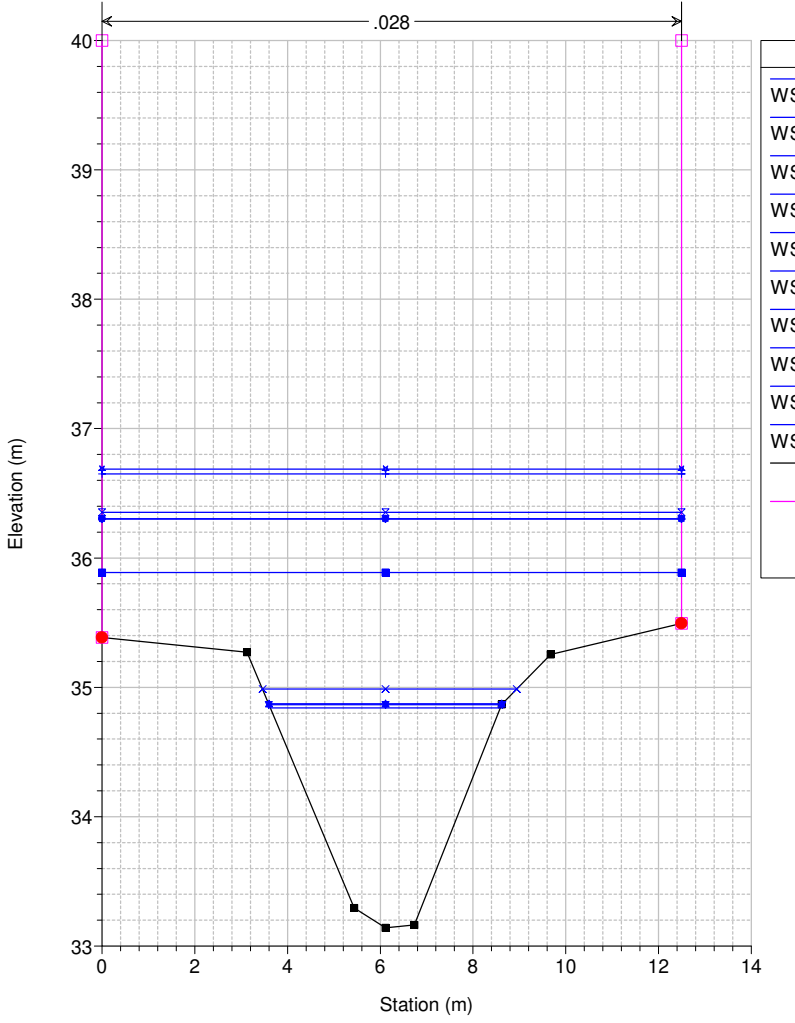

Legend

- WS Max WS - TR200_24_0
- WS Max WS - TR200_18_0
- WS Max WS - TR200_12_0
- WS Max WS - TR200_09_0
- WS Max WS - TR200_36_0
- WS Max WS - TR200_06_0
- WS Max WS - TR200_03_0
- WS Max WS - TR200_01_5
- WS Max WS - TR200_01_0
- WS Max WS - TR200_00_5
- Ground
- Levee
- Bank Sta

Studio Scandicci Torrenti Greve-Vingone
River = Fosso Stagnolo Reach = Stagnolo RS = 42 ST0042_A

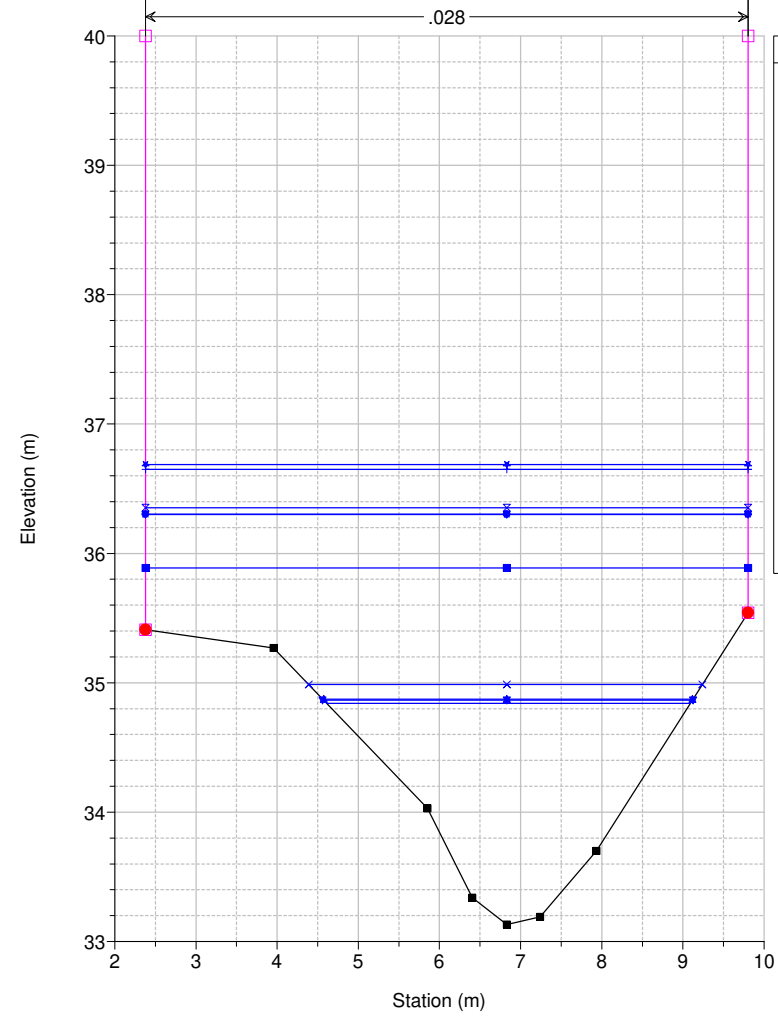

Legend

- WS Max WS - TR200_24_0
- WS Max WS - TR200_18_0
- WS Max WS - TR200_12_0
- WS Max WS - TR200_09_0
- WS Max WS - TR200_36_0
- WS Max WS - TR200_06_0
- WS Max WS - TR200_03_0
- WS Max WS - TR200_01_5
- WS Max WS - TR200_01_0
- WS Max WS - TR200_00_5
- Ground
- Levee
- Bank Sta

Studio Scandicci Torrenti Greve-Vingone
River = Fosso Stagnolo Reach = Stagnolo RS = 41 ST0042_B

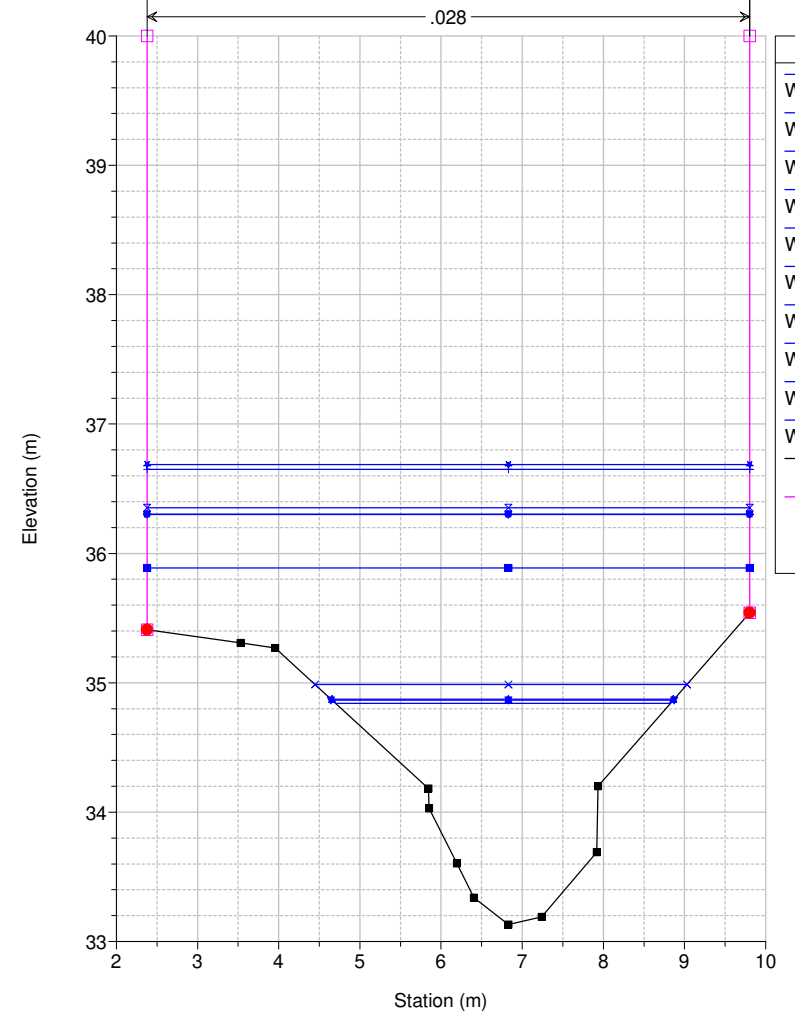

Legend

- WS Max WS - TR200_24_0
- WS Max WS - TR200_18_0
- WS Max WS - TR200_12_0
- WS Max WS - TR200_09_0
- WS Max WS - TR200_36_0
- WS Max WS - TR200_06_0
- WS Max WS - TR200_03_0
- WS Max WS - TR200_01_5
- WS Max WS - TR200_01_0
- WS Max WS - TR200_00_5
- Ground
- Levee
- Bank Sta

Studio Scandicci Torrenti Greve-Vingone
River = Fosso Stagnolo Reach = Stagnolo RS = 40.5 BR

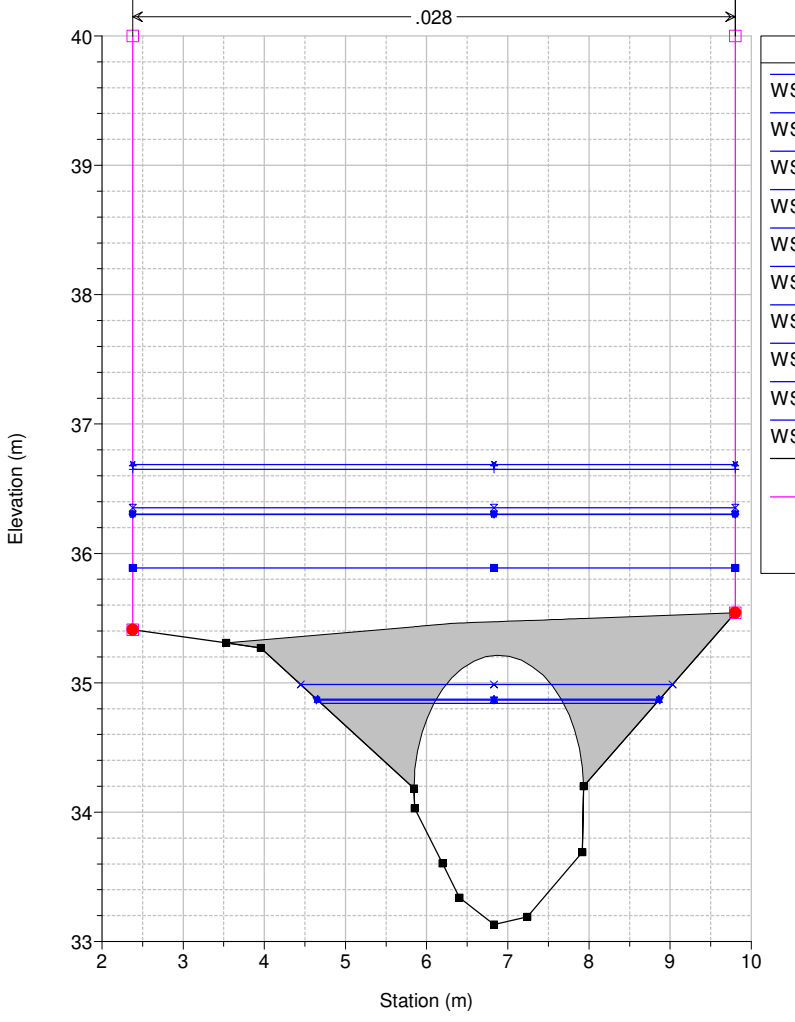

Legend

- WS Max WS - TR200_24_0
- WS Max WS - TR200_18_0
- WS Max WS - TR200_12_0
- WS Max WS - TR200_09_0
- WS Max WS - TR200_36_0
- WS Max WS - TR200_06_0
- WS Max WS - TR200_03_0
- WS Max WS - TR200_01_5
- WS Max WS - TR200_01_0
- WS Max WS - TR200_00_5
- Ground
- Levee
- Bank Sta

Studio Scandicci Torrenti Greve-Vingone
River = Fosso Stagnolo Reach = Stagnolo RS = 40.5 BR

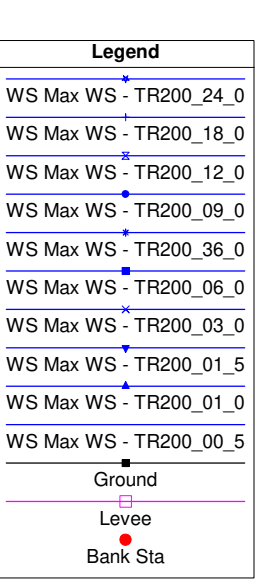
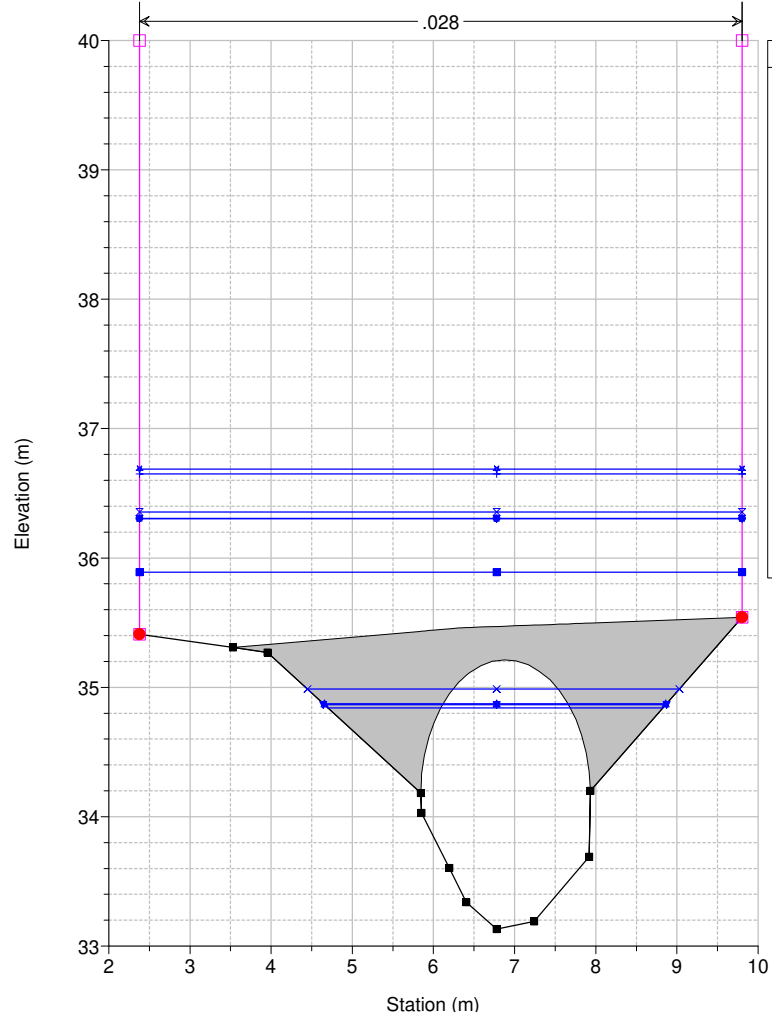

Studio Scandicci Torrenti Greve-Vingone
River = Fosso Stagnolo Reach = Stagnolo RS = 40 ST0042_C

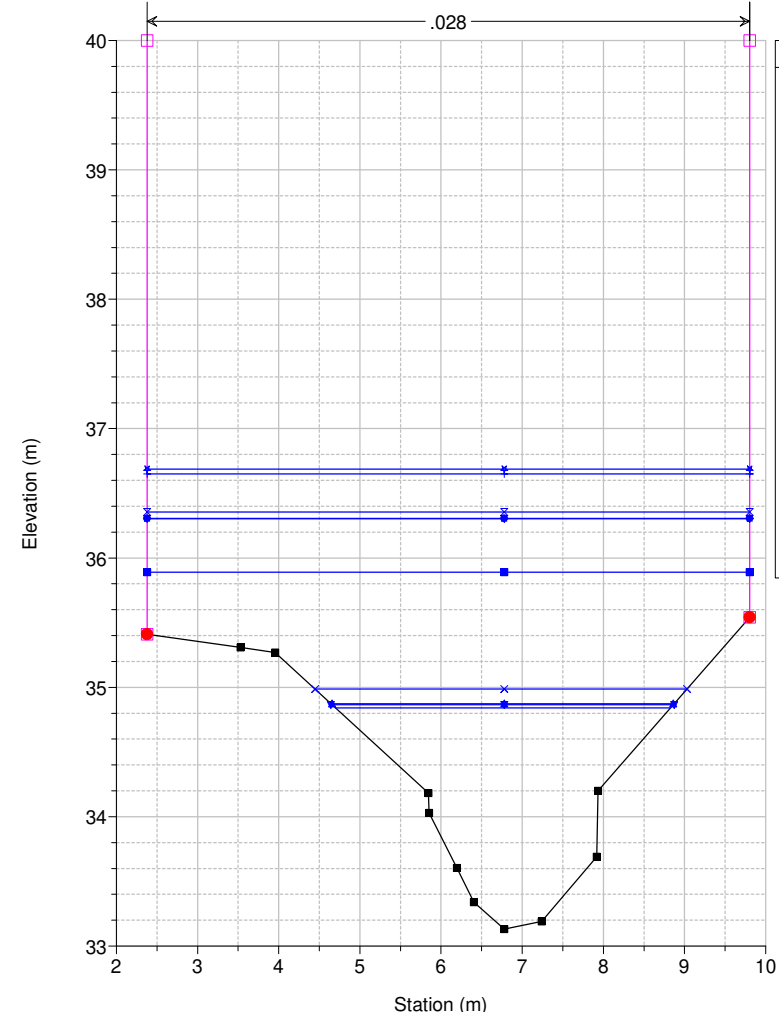

Studio Scandicci Torrenti Greve-Vingone
River = Fosso Stagnolo Reach = Stagnolo RS = 39 ST0042_D

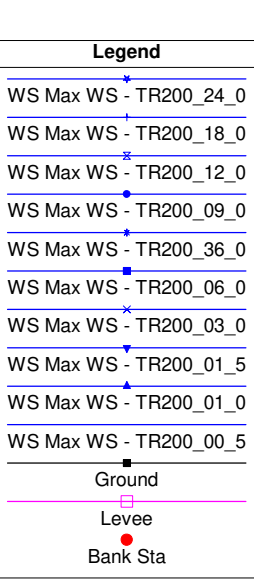
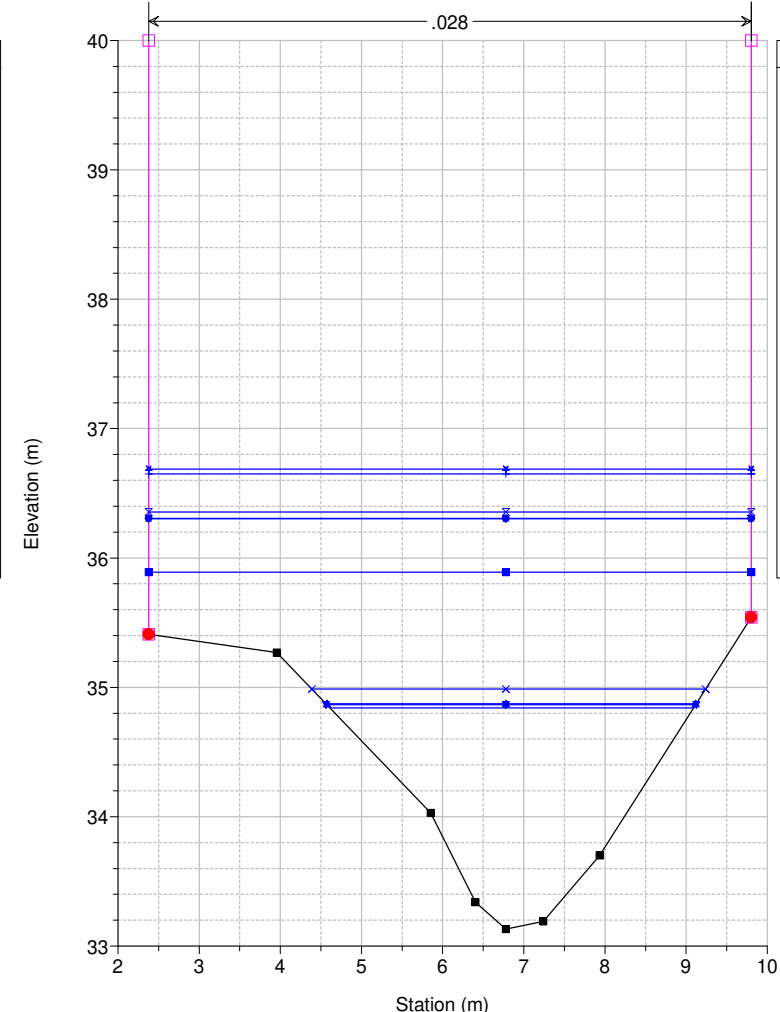

Studio Scandicci Torrenti Greve-Vingone
River = Fosso Stagnolo Reach = Stagnolo RS = 38 ST0043_

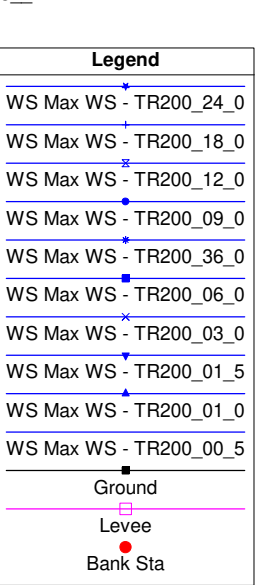
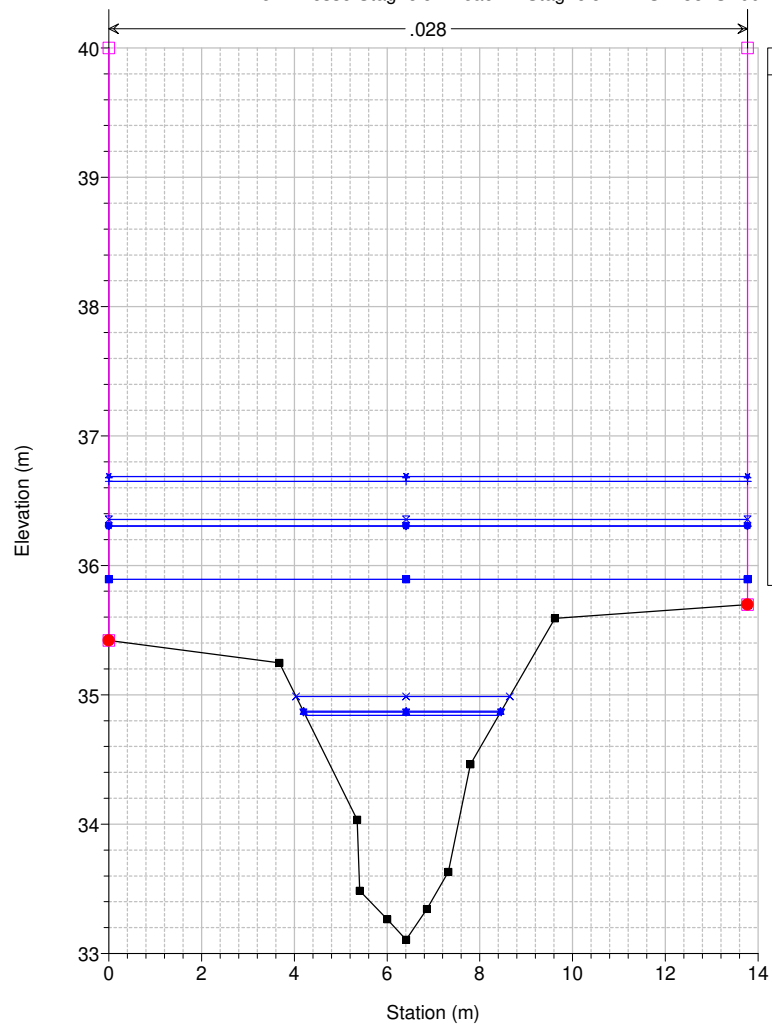

Studio Scandicci Torrenti Greve-Vingone
River = Fosso Stagnolo Reach = Stagnolo RS = 37 ST0044_A

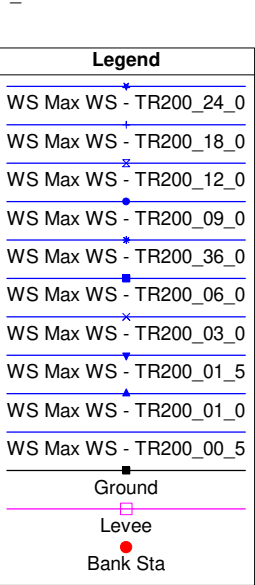
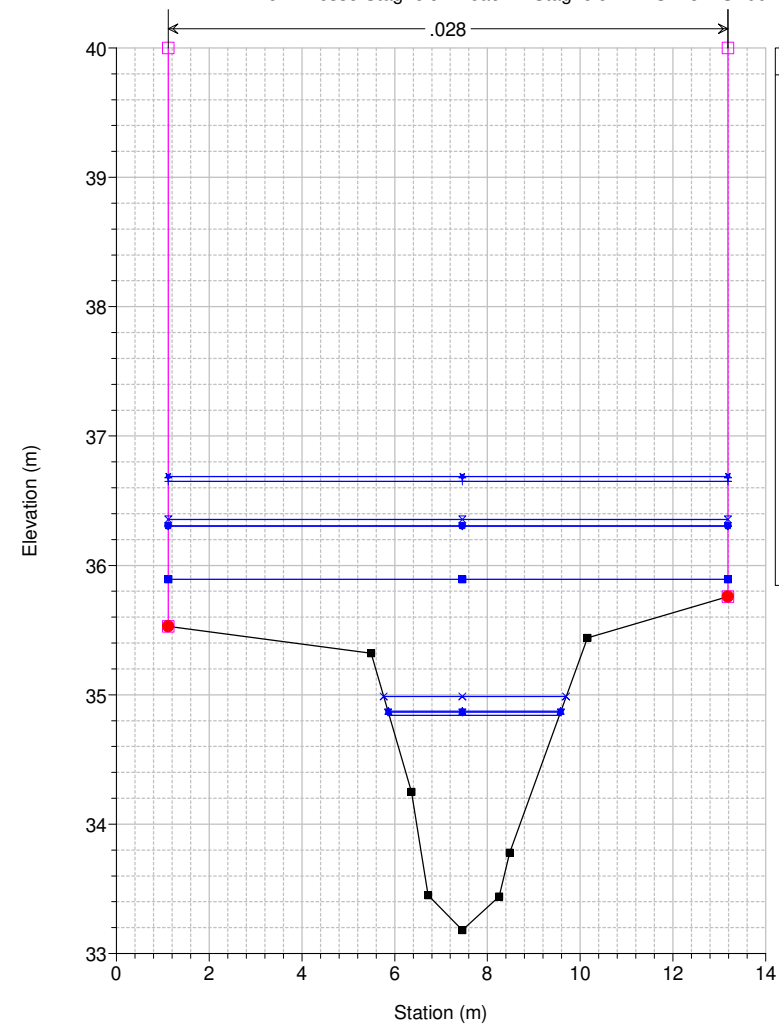

Studio Scandicci Torrenti Greve-Vingone
River = Fosso Stagnolo Reach = Stagnolo RS = 36 ST0044_B

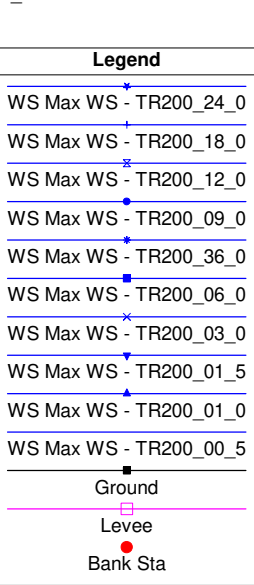
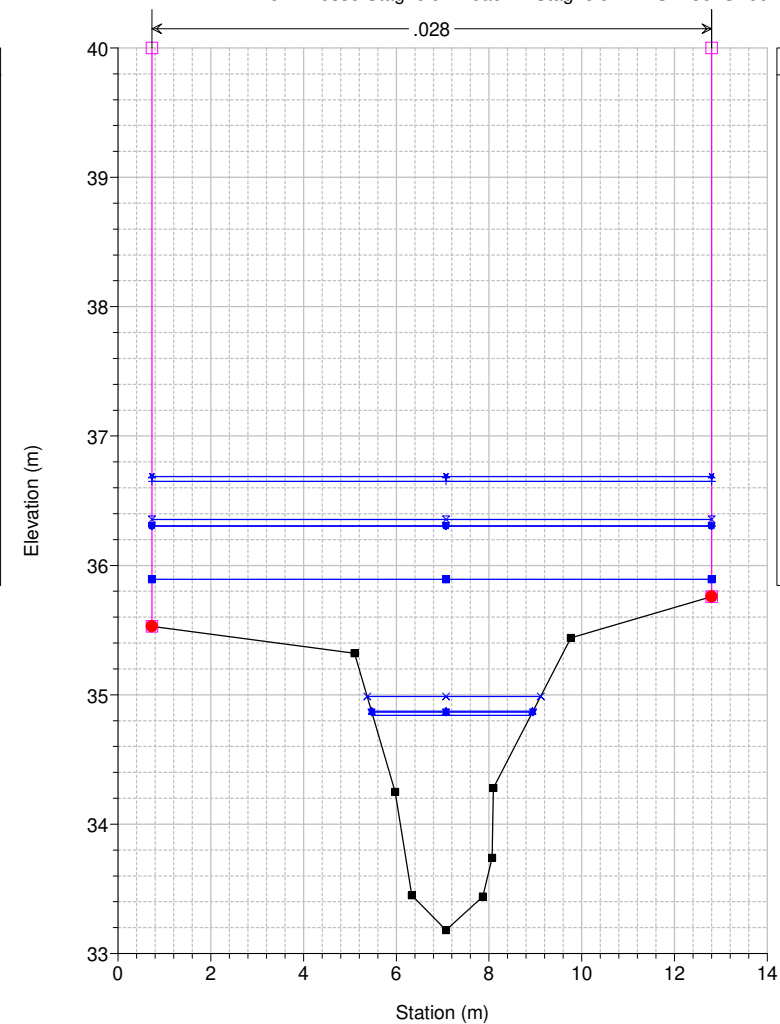

Studio Scandicci Torrenti Greve-Vingone
River = Fosso Stagnolo Reach = Stagnolo RS = 35.5 BR

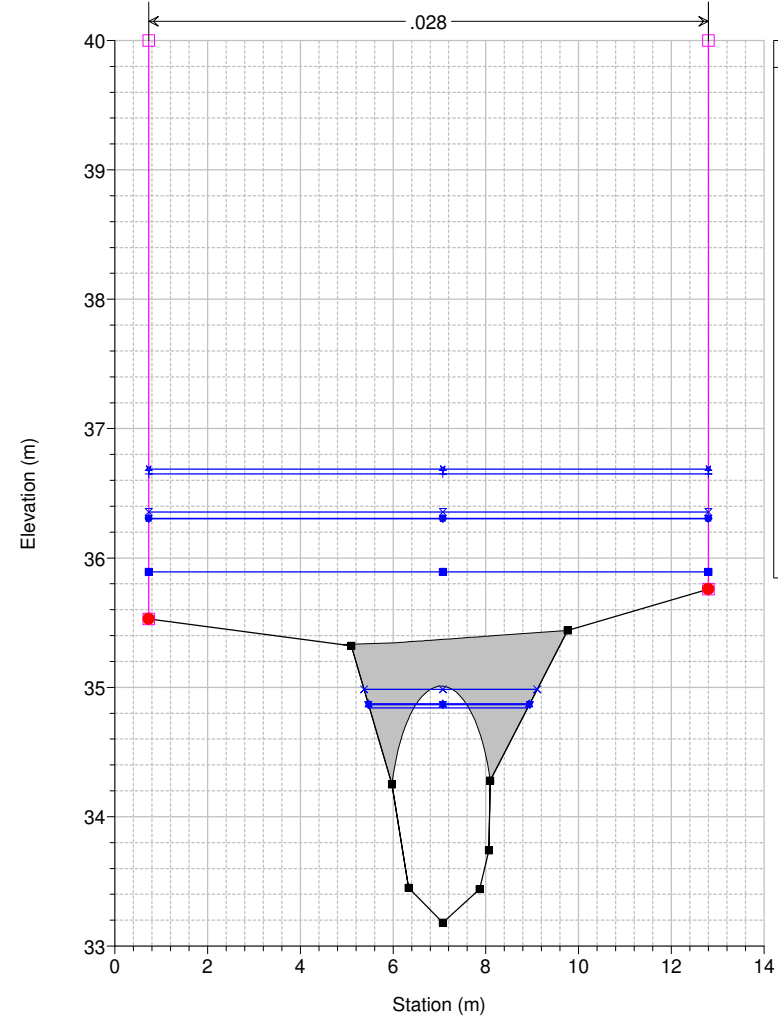

Legend	
WS Max WS - TR200_24_0	+
WS Max WS - TR200_18_0	+
WS Max WS - TR200_12_0	x
WS Max WS - TR200_09_0	•
WS Max WS - TR200_36_0	■
WS Max WS - TR200_06_0	■
WS Max WS - TR200_03_0	x
WS Max WS - TR200_01_5	▼
WS Max WS - TR200_01_0	▲
WS Max WS - TR200_00_5	■
Ground	■
Levee	□
Bank Sta	•

Studio Scandicci Torrenti Greve-Vingone
River = Fosso Stagnolo Reach = Stagnolo RS = 35.5 BR

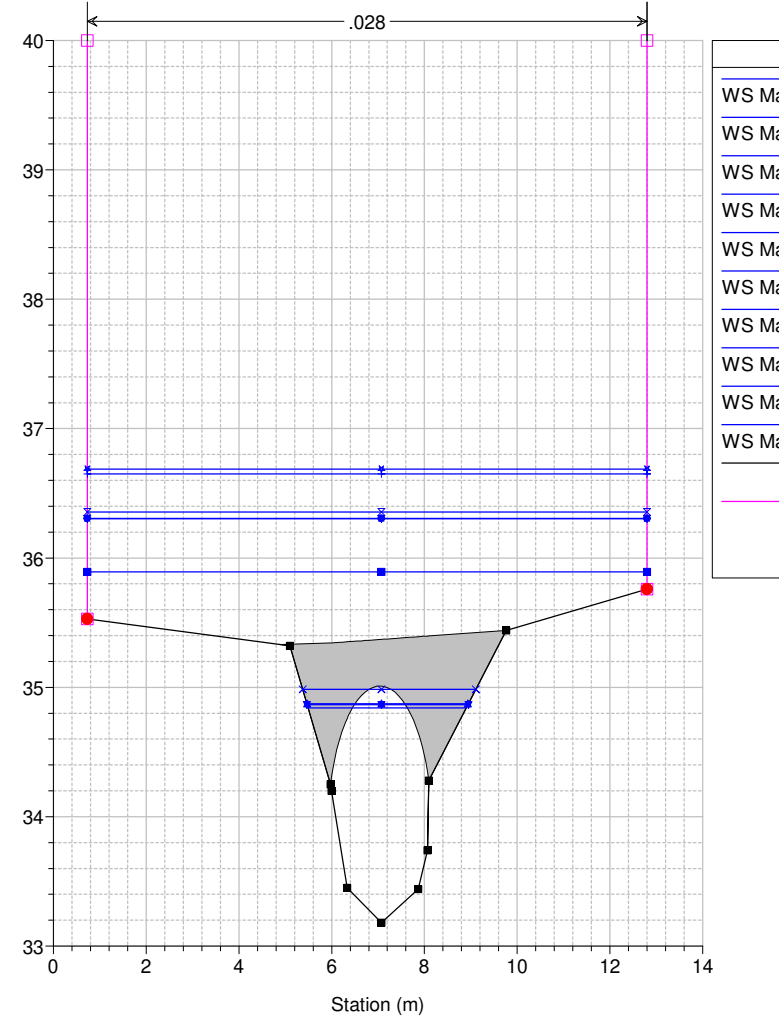

Legend	
WS Max WS - TR200_24_0	+
WS Max WS - TR200_18_0	+
WS Max WS - TR200_12_0	x
WS Max WS - TR200_09_0	•
WS Max WS - TR200_36_0	■
WS Max WS - TR200_06_0	■
WS Max WS - TR200_03_0	x
WS Max WS - TR200_01_5	▼
WS Max WS - TR200_01_0	▲
WS Max WS - TR200_00_5	■
Ground	■
Levee	□
Bank Sta	•

Studio Scandicci Torrenti Greve-Vingone
River = Fosso Stagnolo Reach = Stagnolo RS = 35 ST0044_C

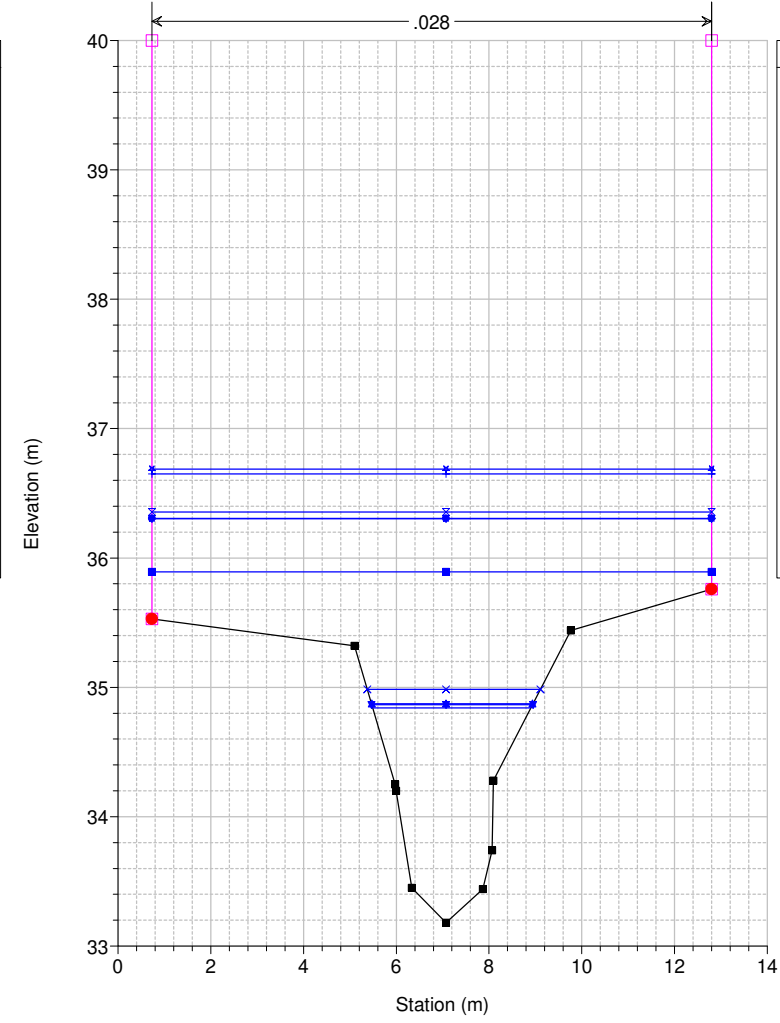

Legend	
WS Max WS - TR200_24_0	+
WS Max WS - TR200_18_0	+
WS Max WS - TR200_12_0	x
WS Max WS - TR200_09_0	•
WS Max WS - TR200_36_0	■
WS Max WS - TR200_06_0	■
WS Max WS - TR200_03_0	x
WS Max WS - TR200_01_5	▼
WS Max WS - TR200_01_0	▲
WS Max WS - TR200_00_5	■
Ground	■
Levee	□
Bank Sta	•

Studio Scandicci Torrenti Greve-Vingone
River = Fosso Stagnolo Reach = Stagnolo RS = 34 ST0044_D

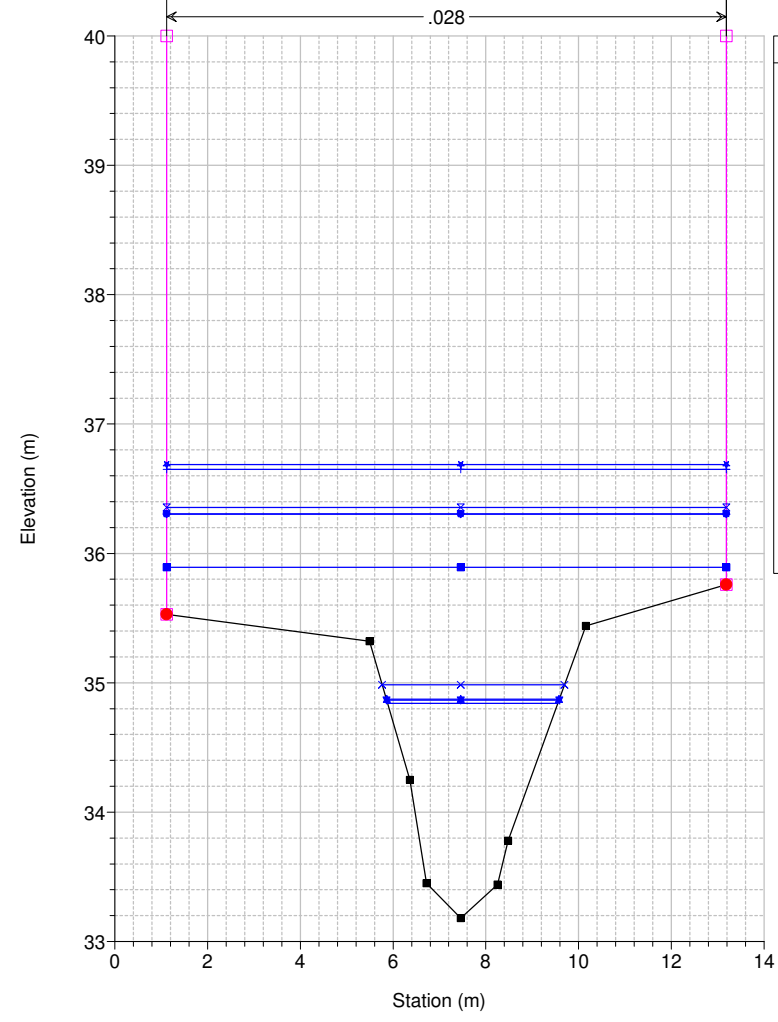

Legend	
WS Max WS - TR200_24_0	+
WS Max WS - TR200_18_0	+
WS Max WS - TR200_12_0	x
WS Max WS - TR200_09_0	•
WS Max WS - TR200_36_0	■
WS Max WS - TR200_06_0	■
WS Max WS - TR200_03_0	x
WS Max WS - TR200_01_5	▼
WS Max WS - TR200_01_0	▲
WS Max WS - TR200_00_5	■
Ground	■
Levee	□
Bank Sta	•

Studio Scandicci Torrenti Greve-Vingone
River = Fosso Stagnolo Reach = Stagnolo RS = 33 ST0045_

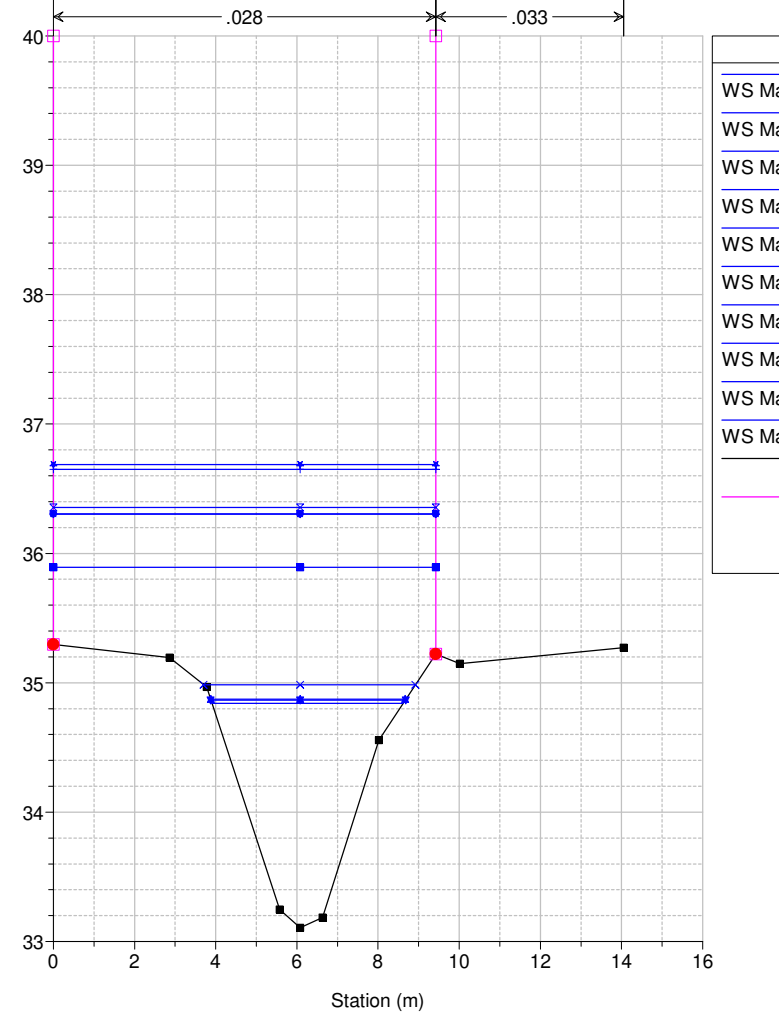

Legend	
WS Max WS - TR200_24_0	+
WS Max WS - TR200_18_0	+
WS Max WS - TR200_12_0	x
WS Max WS - TR200_09_0	•
WS Max WS - TR200_36_0	■
WS Max WS - TR200_06_0	■
WS Max WS - TR200_03_0	x
WS Max WS - TR200_01_5	▼
WS Max WS - TR200_01_0	▲
WS Max WS - TR200_00_5	■
Ground	■
Levee	□
Bank Sta	•

Studio Scandicci Torrenti Greve-Vingone
River = Fosso Stagnolo Reach = Stagnolo RS = 32 ST0046_A

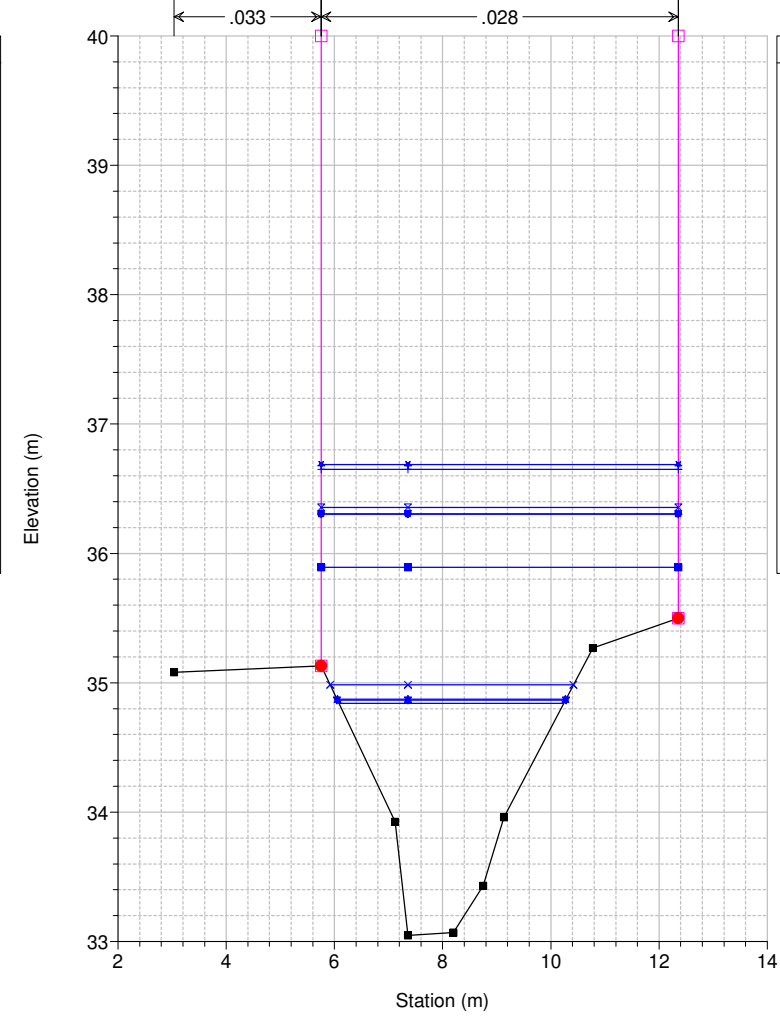

Legend	
WS Max WS - TR200_24_0	+
WS Max WS - TR200_18_0	+
WS Max WS - TR200_12_0	x
WS Max WS - TR200_09_0	•
WS Max WS - TR200_36_0	■
WS Max WS - TR200_06_0	■
WS Max WS - TR200_03_0	x
WS Max WS - TR200_01_5	▼
WS Max WS - TR200_01_0	▲
WS Max WS - TR200_00_5	■
Ground	■
Levee	□
Bank Sta	•

Studio Scandicci Torrenti Greve-Vingone
River = Fosso Stagnolo Reach = Stagnolo RS = 31 ST0046_B

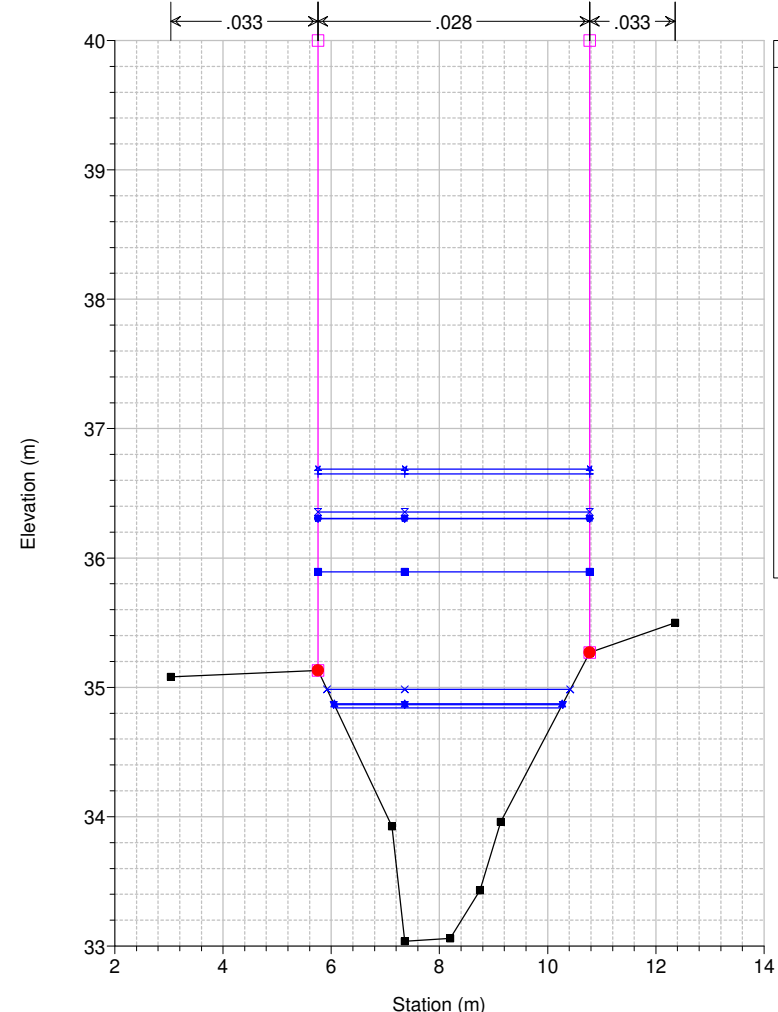

Studio Scandicci Torrenti Greve-Vingone
River = Fosso Stagnolo Reach = Stagnolo RS = 30.5 BR

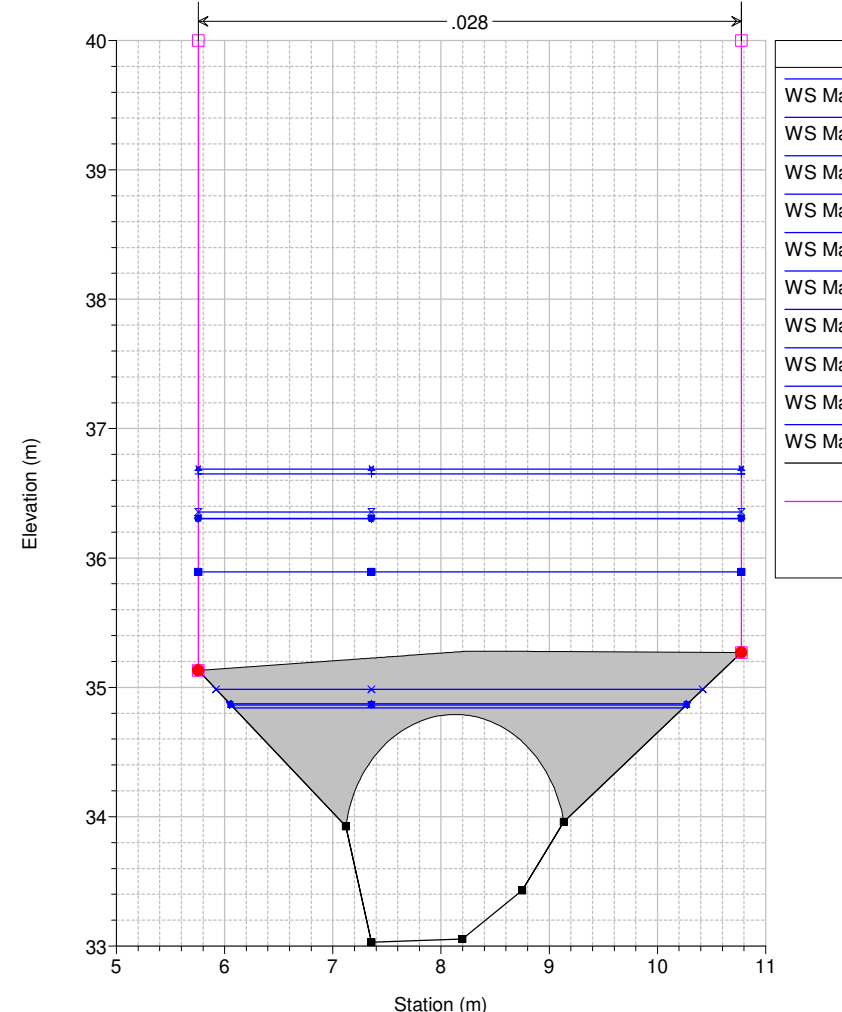

Studio Scandicci Torrenti Greve-Vingone
River = Fosso Stagnolo Reach = Stagnolo RS = 30.5 BR

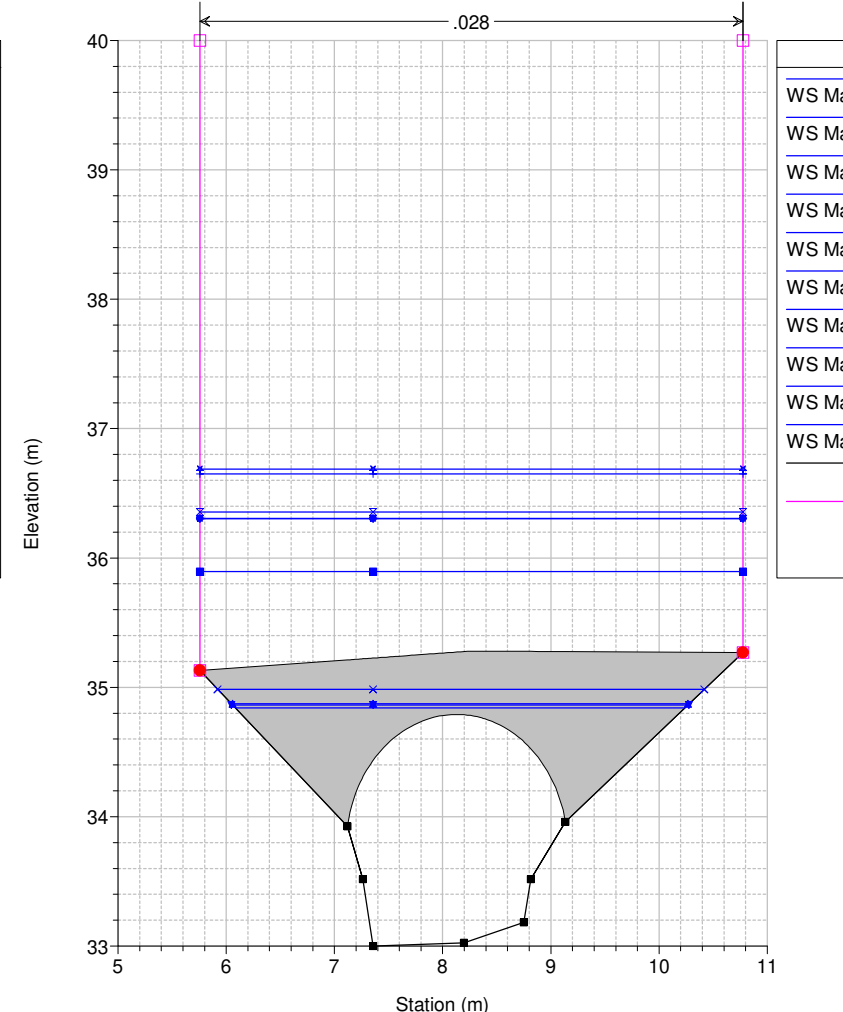

Studio Scandicci Torrenti Greve-Vingone
River = Fosso Stagnolo Reach = Stagnolo RS = 30 ST0046_C

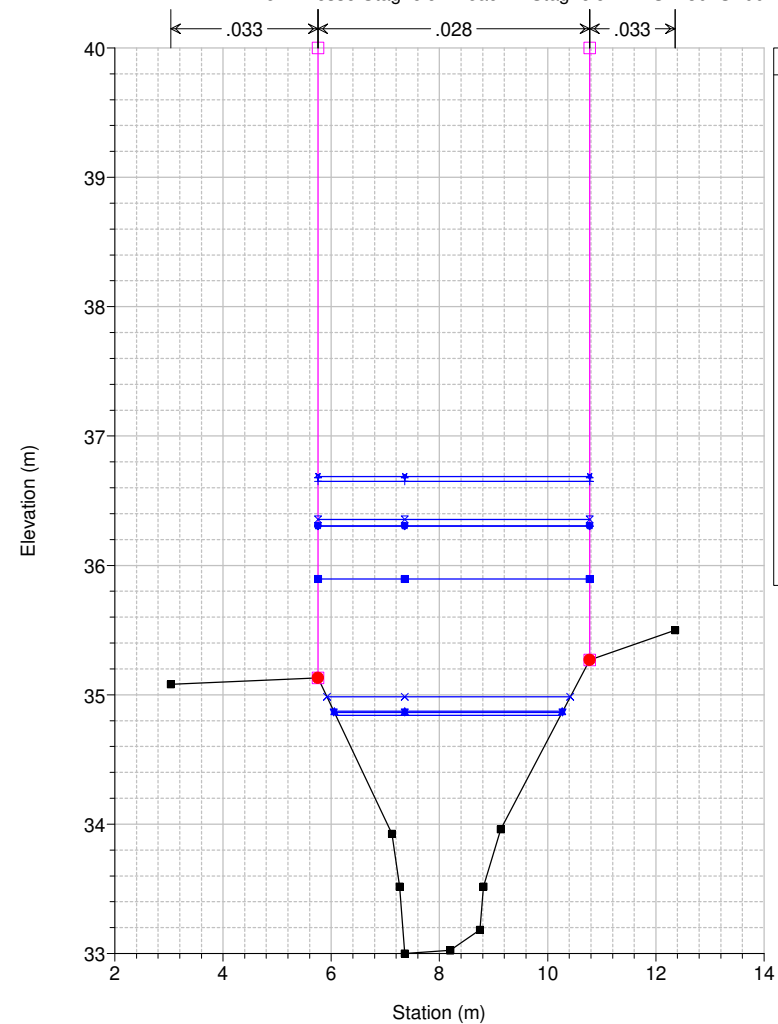

Studio Scandicci Torrenti Greve-Vingone
River = Fosso Stagnolo Reach = Stagnolo RS = 29 ST0046_D

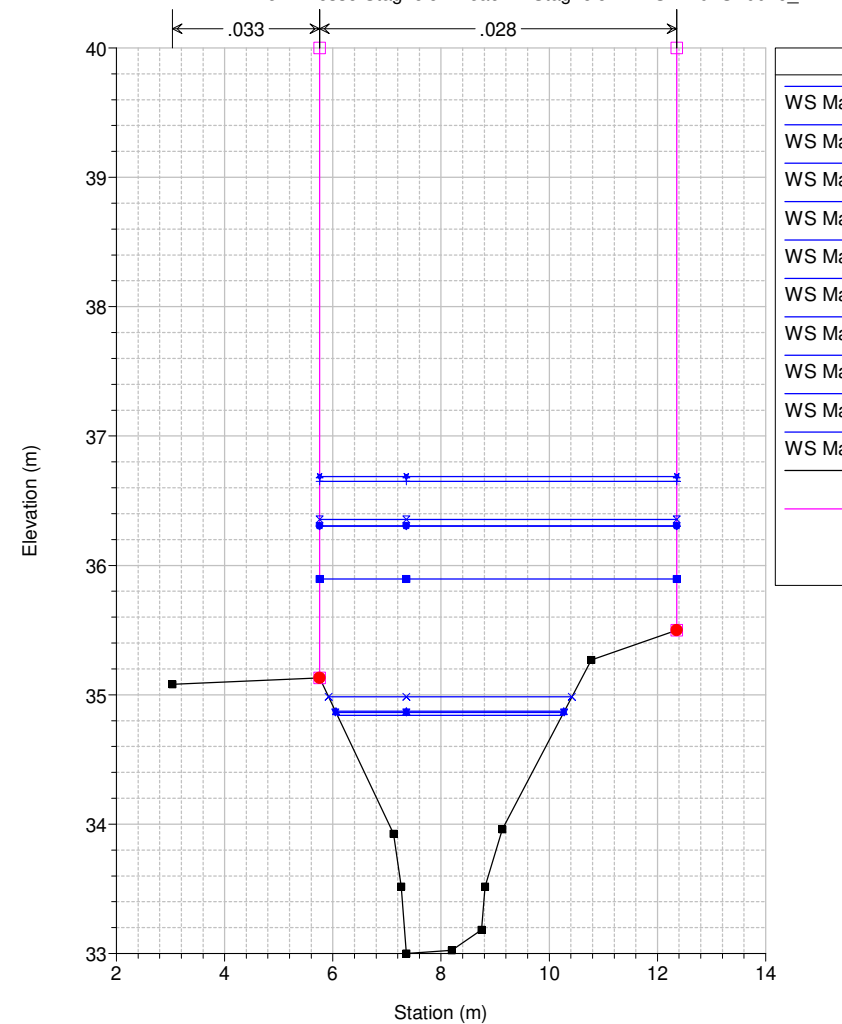

Studio Scandicci Torrenti Greve-Vingone
River = Fosso Stagnolo Reach = Stagnolo RS = 28 ST0047_

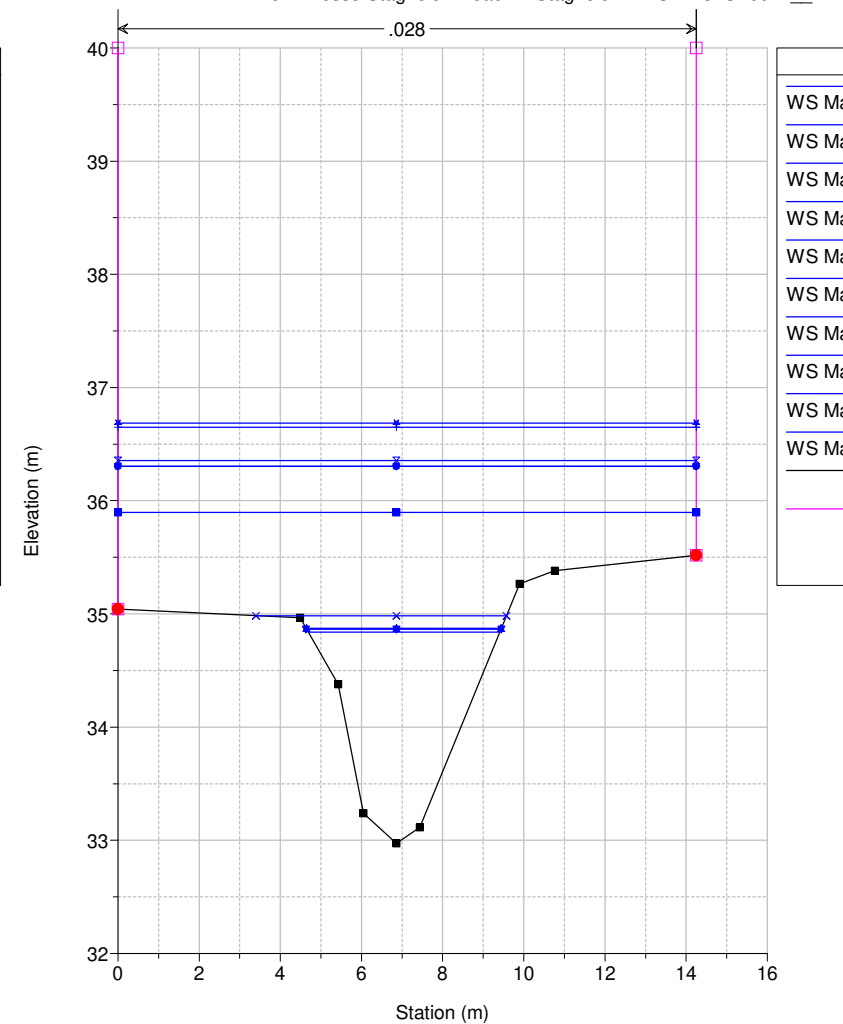

Studio Scandicci Torrenti Greve-Vingone
River = Fosso Stagnolo Reach = Stagnolo RS = 27 ST0048__

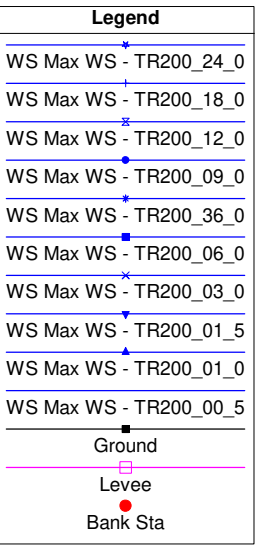
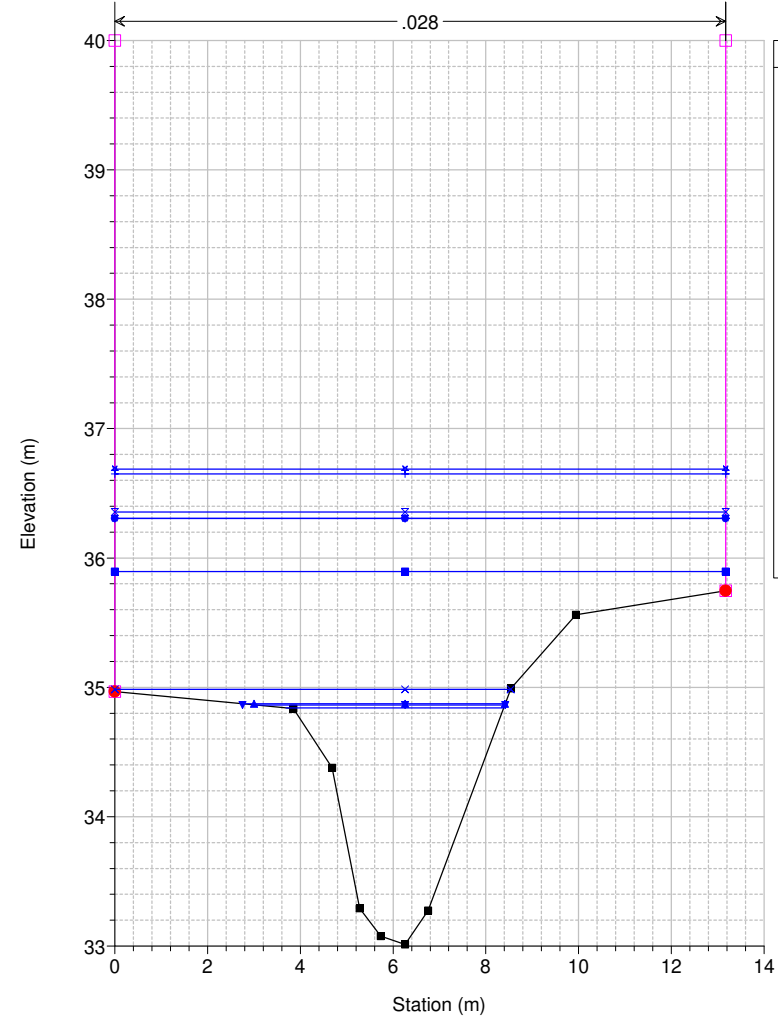

Studio Scandicci Torrenti Greve-Vingone
River = Fosso Stagnolo Reach = Stagnolo RS = 26 ST0049__

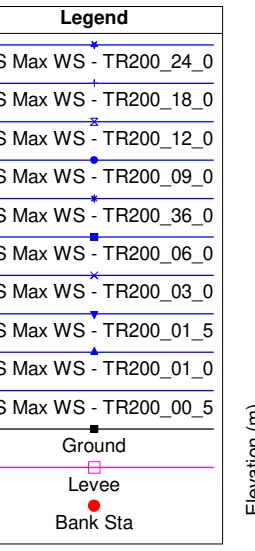
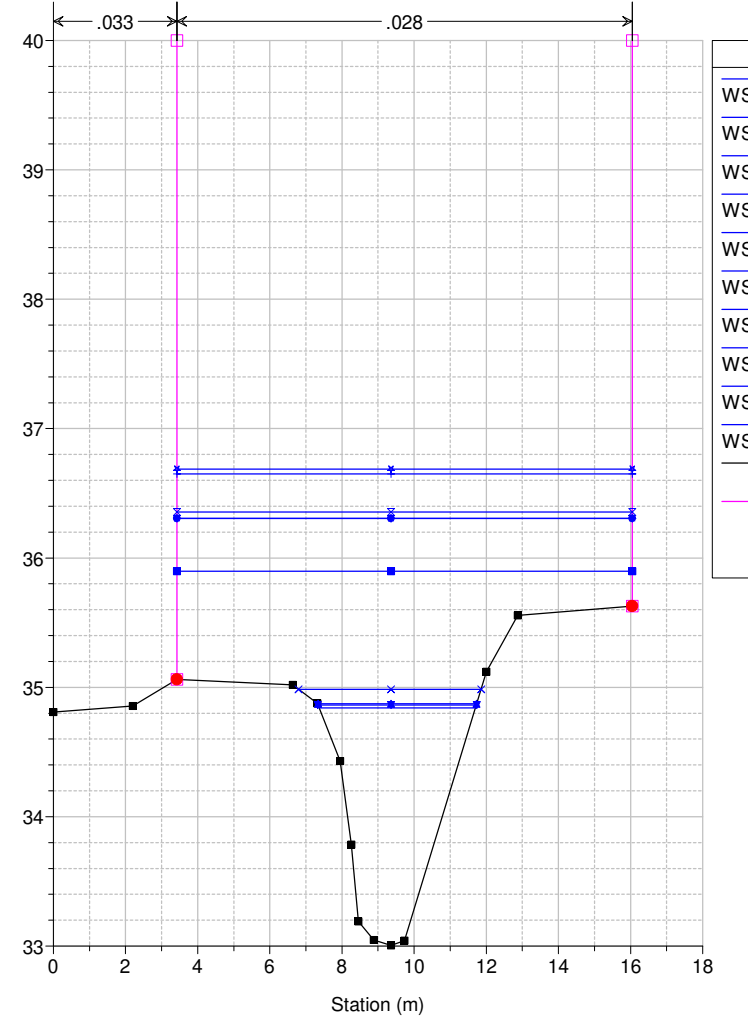

Studio Scandicci Torrenti Greve-Vingone
River = Fosso Stagnolo Reach = Stagnolo RS = 25 ST0050_A

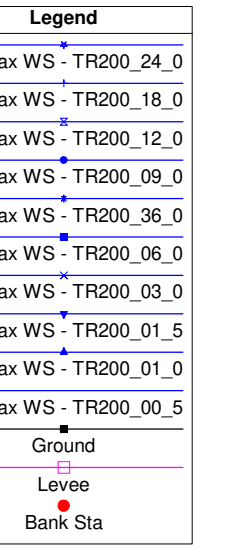
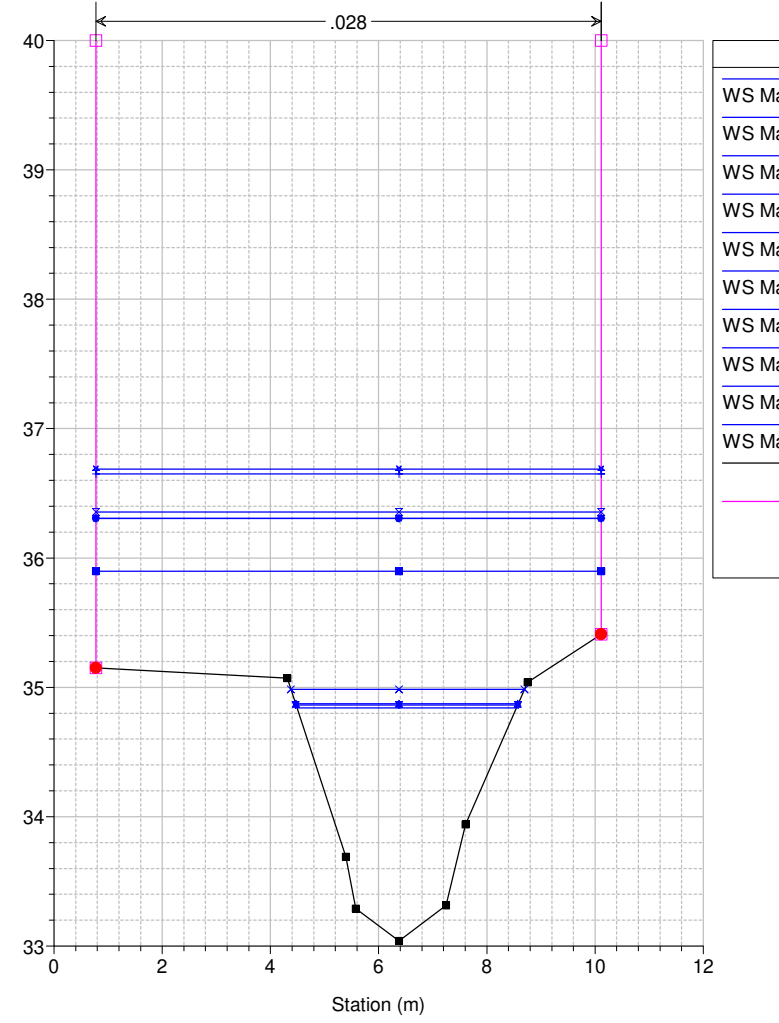

Studio Scandicci Torrenti Greve-Vingone
River = Fosso Stagnolo Reach = Stagnolo RS = 24 ST0050_B

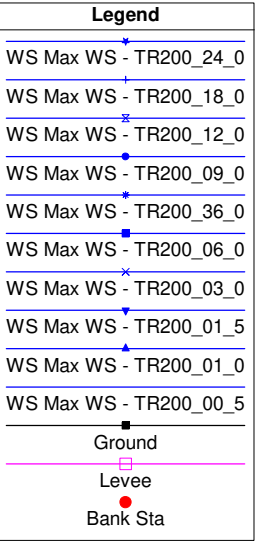
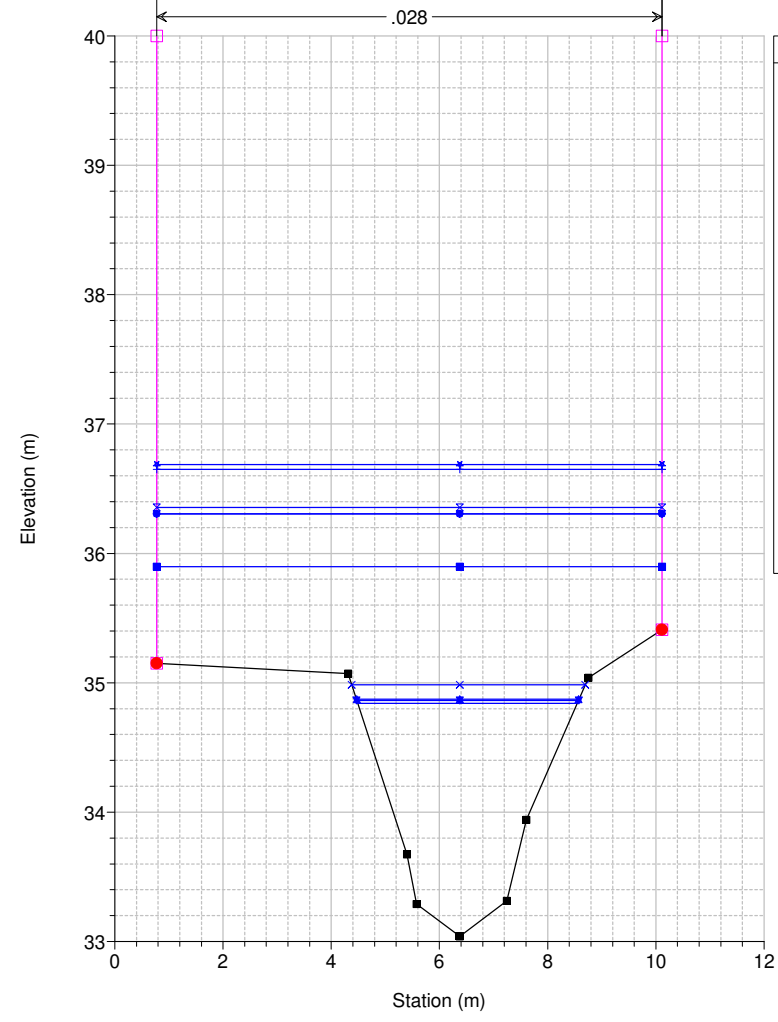

Studio Scandicci Torrenti Greve-Vingone
River = Fosso Stagnolo Reach = Stagnolo RS = 23.5 BR

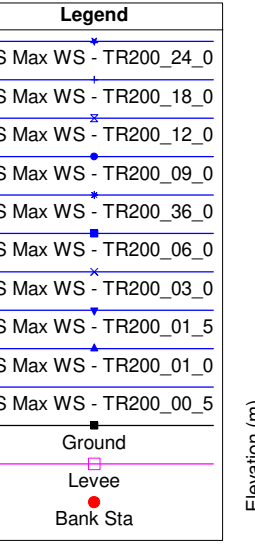
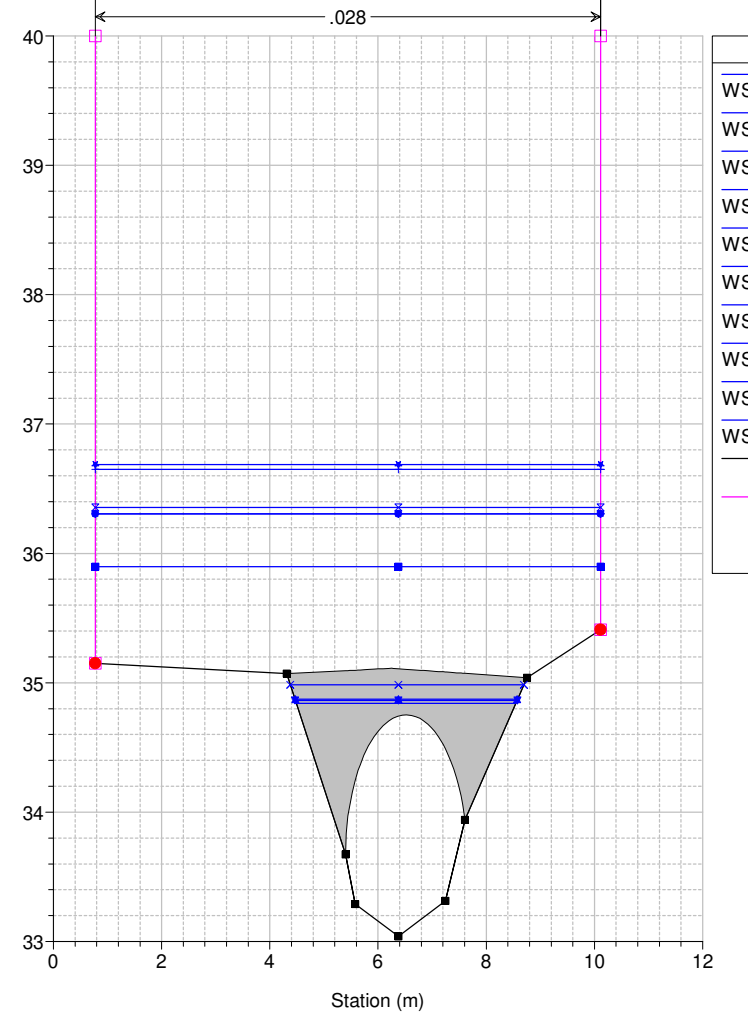

Studio Scandicci Torrenti Greve-Vingone
River = Fosso Stagnolo Reach = Stagnolo RS = 23.5 BR

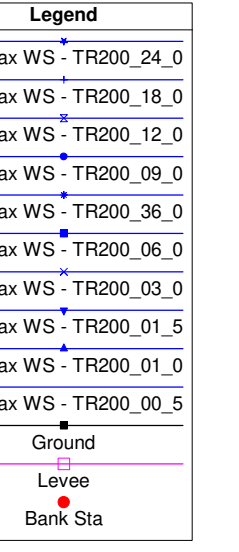
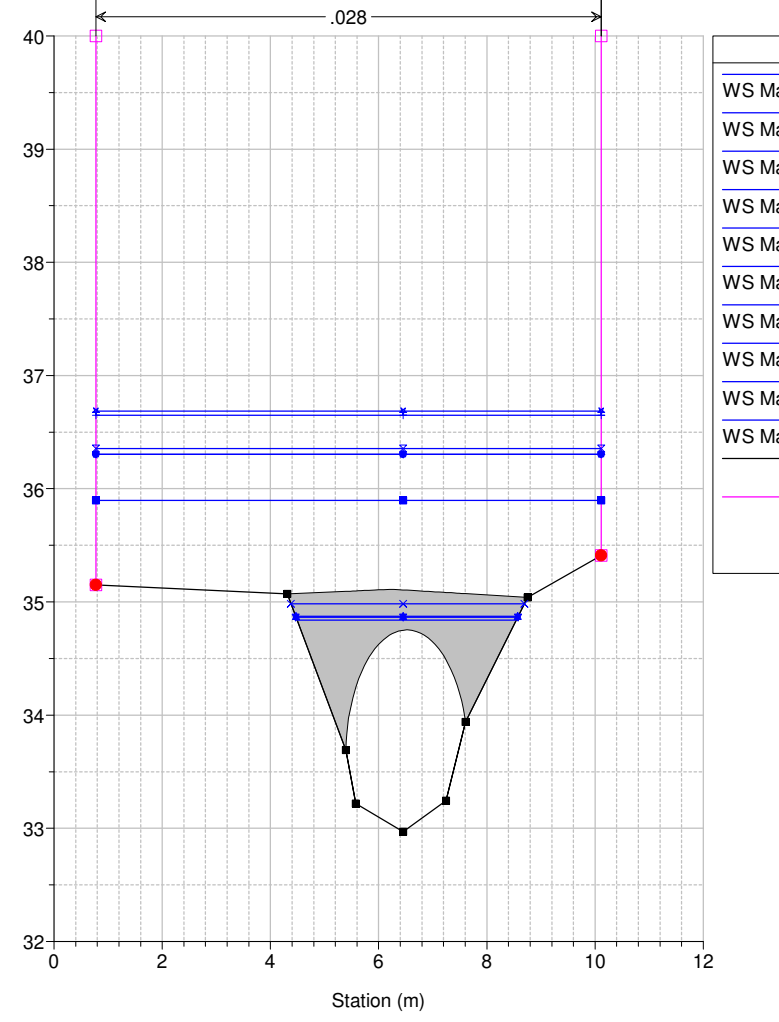

Studio Scandicci Torrenti Greve-Vingone
River = Fosso Stagnolo Reach = Stagnolo RS = 23 ST0050_C

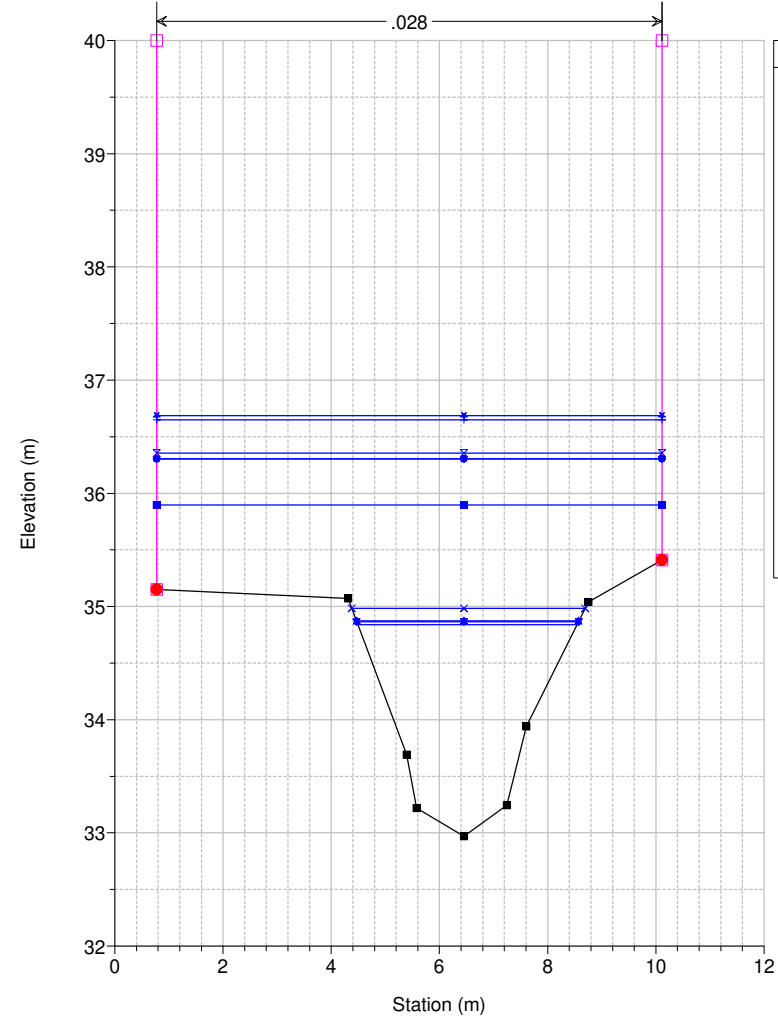

Legend	
WS Max WS - TR200_24_0	+
WS Max WS - TR200_18_0	+
WS Max WS - TR200_12_0	x
WS Max WS - TR200_09_0	•
WS Max WS - TR200_36_0	■
WS Max WS - TR200_06_0	■
WS Max WS - TR200_03_0	x
WS Max WS - TR200_01_5	▼
WS Max WS - TR200_01_0	▲
WS Max WS - TR200_00_5	■
Ground	—
Levee	□
Bank Sta	•

Studio Scandicci Torrenti Greve-Vingone
River = Fosso Stagnolo Reach = Stagnolo RS = 22 ST0050_D

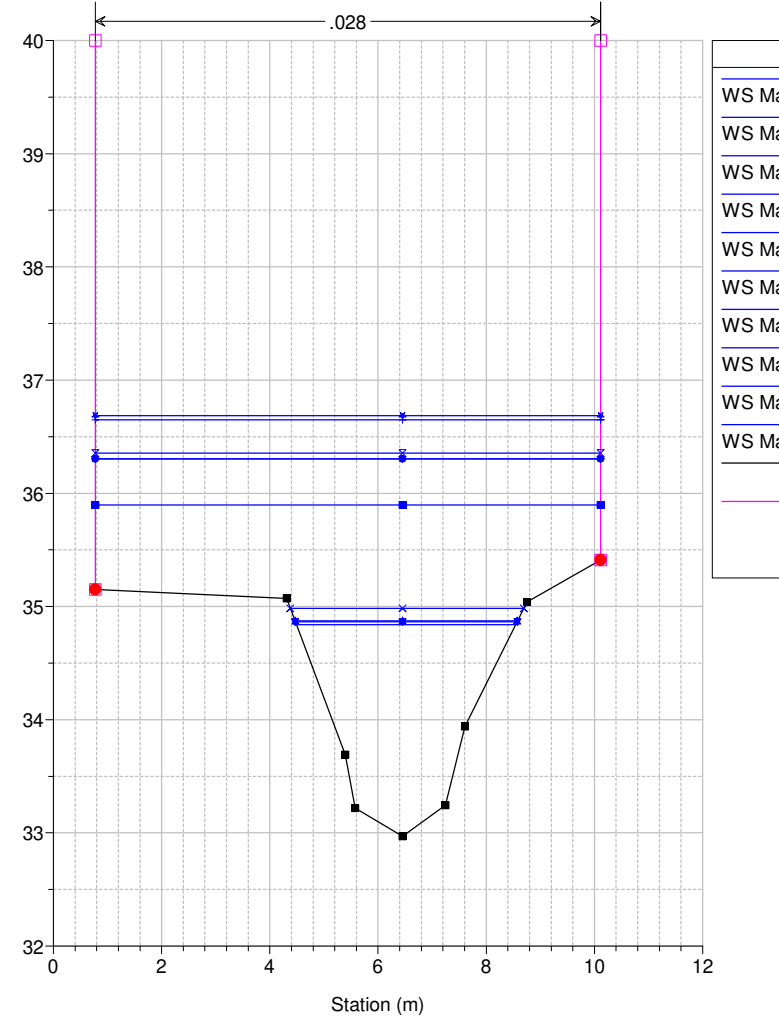

Legend	
WS Max WS - TR200_24_0	+
WS Max WS - TR200_18_0	+
WS Max WS - TR200_12_0	x
WS Max WS - TR200_09_0	•
WS Max WS - TR200_36_0	■
WS Max WS - TR200_06_0	■
WS Max WS - TR200_03_0	x
WS Max WS - TR200_01_5	▼
WS Max WS - TR200_01_0	▲
WS Max WS - TR200_00_5	■
Ground	—
Levee	□
Bank Sta	•

Studio Scandicci Torrenti Greve-Vingone
River = Fosso Stagnolo Reach = Stagnolo RS = 21 ST0051_

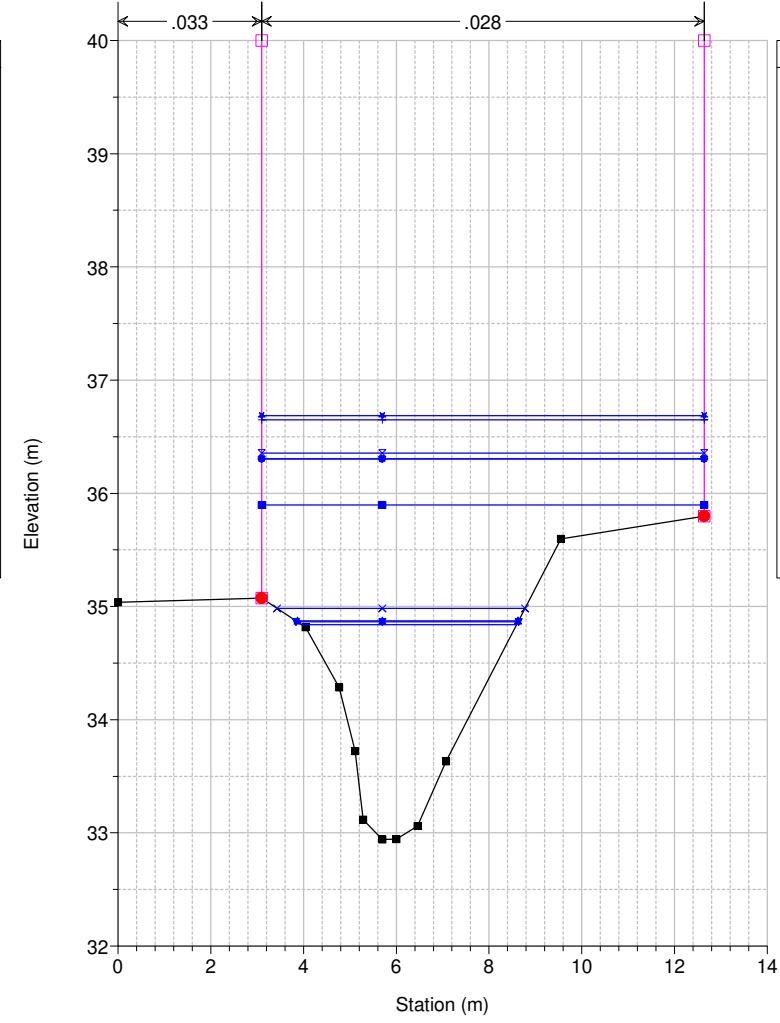

Legend	
WS Max WS - TR200_24_0	+
WS Max WS - TR200_18_0	+
WS Max WS - TR200_12_0	x
WS Max WS - TR200_09_0	•
WS Max WS - TR200_36_0	■
WS Max WS - TR200_06_0	■
WS Max WS - TR200_03_0	x
WS Max WS - TR200_01_5	▼
WS Max WS - TR200_01_0	▲
WS Max WS - TR200_00_5	■
Ground	—
Levee	□
Bank Sta	•

Studio Scandicci Torrenti Greve-Vingone
River = Fosso Stagnolo Reach = Stagnolo RS = 20 ST0052_

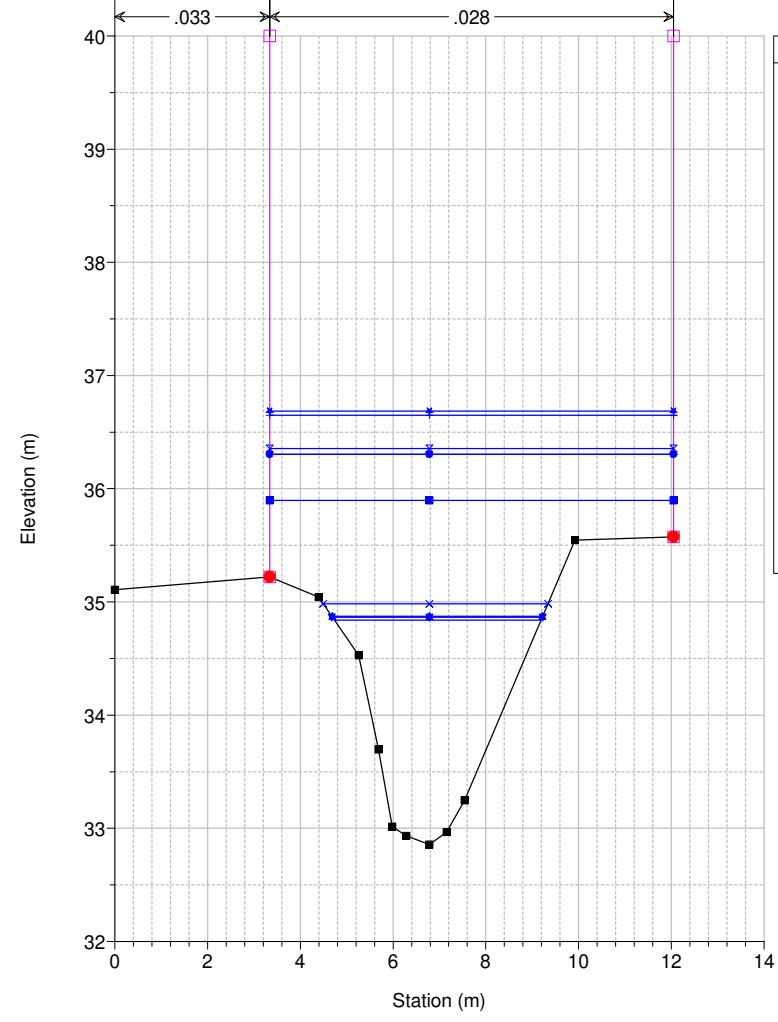

Legend	
WS Max WS - TR200_24_0	+
WS Max WS - TR200_18_0	+
WS Max WS - TR200_12_0	x
WS Max WS - TR200_36_0	■
WS Max WS - TR200_09_0	•
WS Max WS - TR200_06_0	■
WS Max WS - TR200_03_0	x
WS Max WS - TR200_01_5	▼
WS Max WS - TR200_01_0	▲
WS Max WS - TR200_00_5	■
Ground	—
Levee	□
Bank Sta	•

Studio Scandicci Torrenti Greve-Vingone
River = Fosso Stagnolo Reach = Stagnolo RS = 19 ST0053_

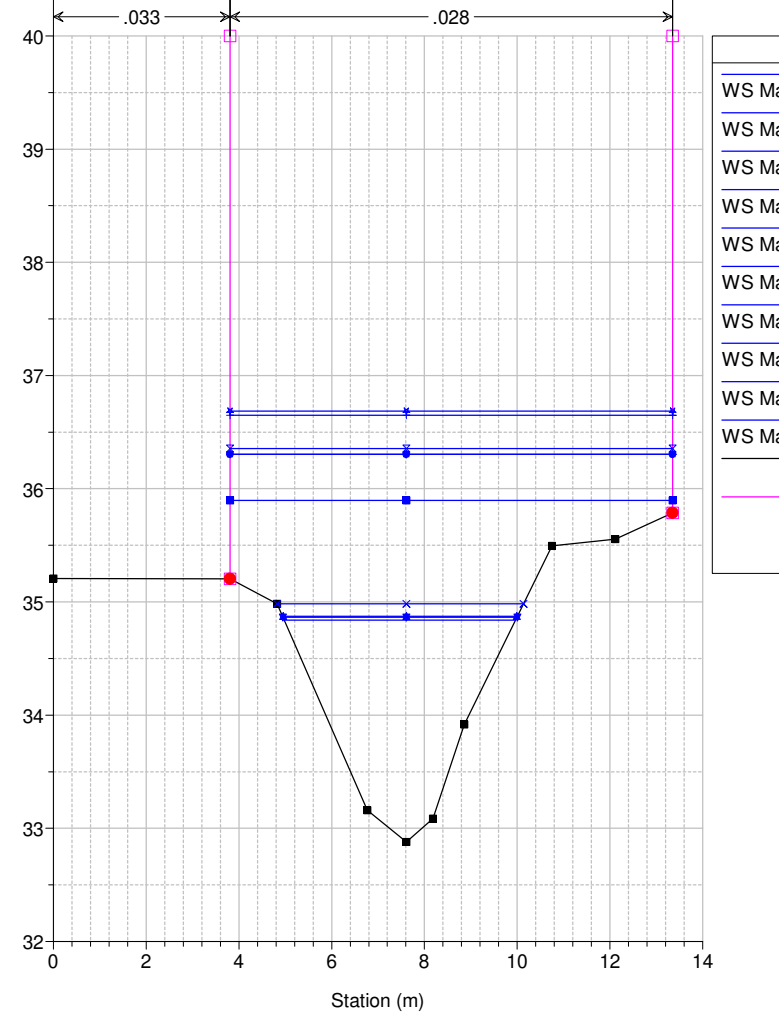

Legend	
WS Max WS - TR200_24_0	+
WS Max WS - TR200_18_0	+
WS Max WS - TR200_12_0	x
WS Max WS - TR200_36_0	■
WS Max WS - TR200_09_0	•
WS Max WS - TR200_06_0	■
WS Max WS - TR200_03_0	x
WS Max WS - TR200_01_5	▼
WS Max WS - TR200_01_0	▲
WS Max WS - TR200_00_5	■
Ground	—
Levee	□
Bank Sta	•

Studio Scandicci Torrenti Greve-Vingone
River = Fosso Stagnolo Reach = Stagnolo RS = 18 ST0054_

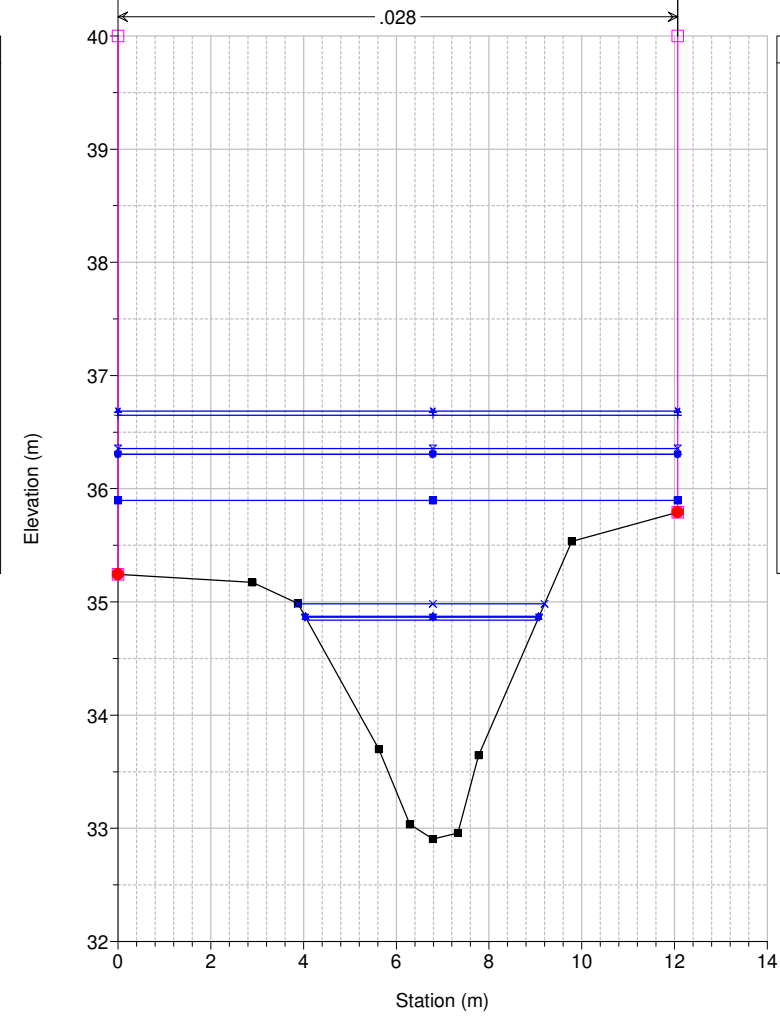

Legend	
WS Max WS - TR200_24_0	+
WS Max WS - TR200_18_0	+
WS Max WS - TR200_12_0	x
WS Max WS - TR200_36_0	■
WS Max WS - TR200_09_0	•
WS Max WS - TR200_06_0	■
WS Max WS - TR200_03_0	x
WS Max WS - TR200_01_5	▼
WS Max WS - TR200_01_0	▲
WS Max WS - TR200_00_5	■
Ground	—
Levee	□
Bank Sta	•

Studio Scandicci Torrenti Greve-Vingone
River = Fosso Stagnolo Reach = Stagnolo RS = 17 ST0055_

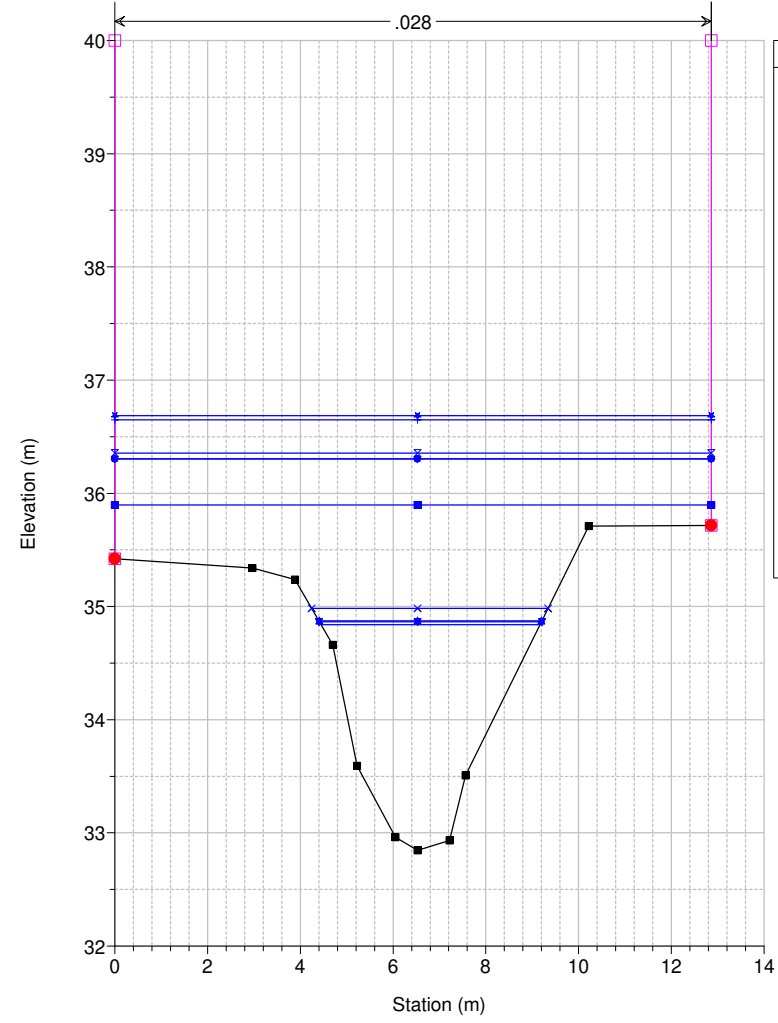

Legend	
WS Max WS - TR200_24_0	+
WS Max WS - TR200_18_0	+
WS Max WS - TR200_12_0	x
WS Max WS - TR200_36_0	•
WS Max WS - TR200_09_0	•
WS Max WS - TR200_36_0	■
WS Max WS - TR200_06_0	■
WS Max WS - TR200_03_0	x
WS Max WS - TR200_01_5	▼
WS Max WS - TR200_01_0	▲
WS Max WS - TR200_00_5	■
Ground	■
Levee	□
Bank Sta	•

Studio Scandicci Torrenti Greve-Vingone
River = Fosso Stagnolo Reach = Stagnolo RS = 16 ST0056_

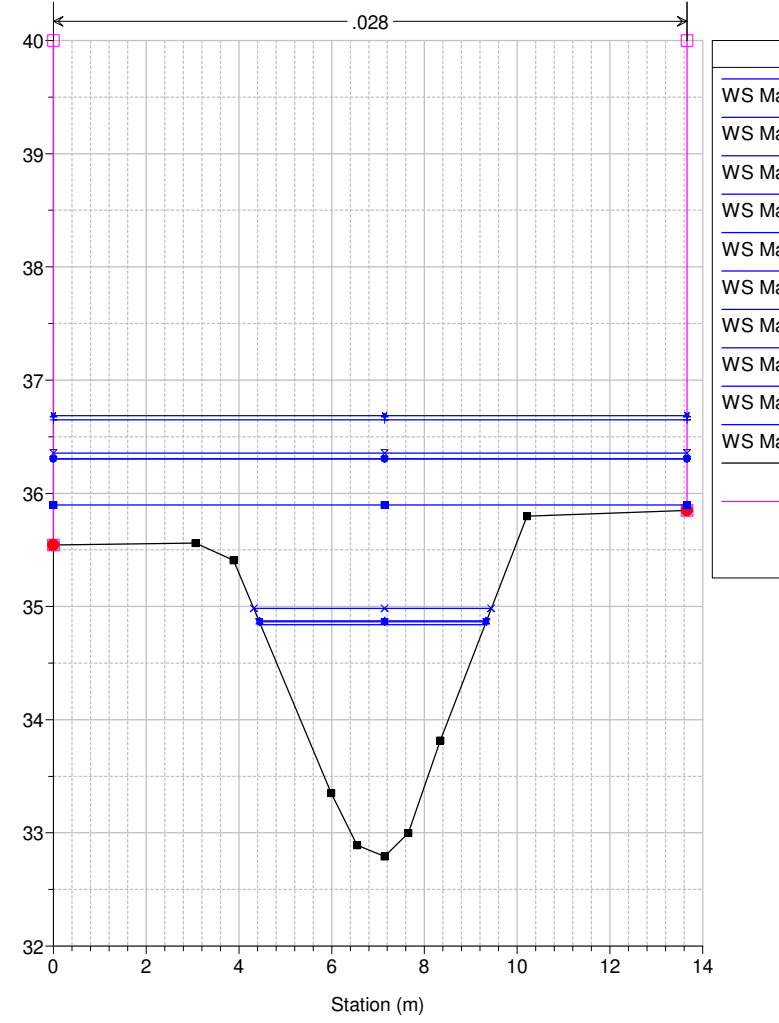

Legend	
WS Max WS - TR200_24_0	+
WS Max WS - TR200_18_0	+
WS Max WS - TR200_12_0	x
WS Max WS - TR200_09_0	•
WS Max WS - TR200_36_0	•
WS Max WS - TR200_06_0	■
WS Max WS - TR200_06_0	■
WS Max WS - TR200_03_0	x
WS Max WS - TR200_01_5	▼
WS Max WS - TR200_01_0	▲
WS Max WS - TR200_00_5	■
Ground	■
Levee	□
Bank Sta	•

Studio Scandicci Torrenti Greve-Vingone
River = Fosso Stagnolo Reach = Stagnolo RS = 15 ST0057_A

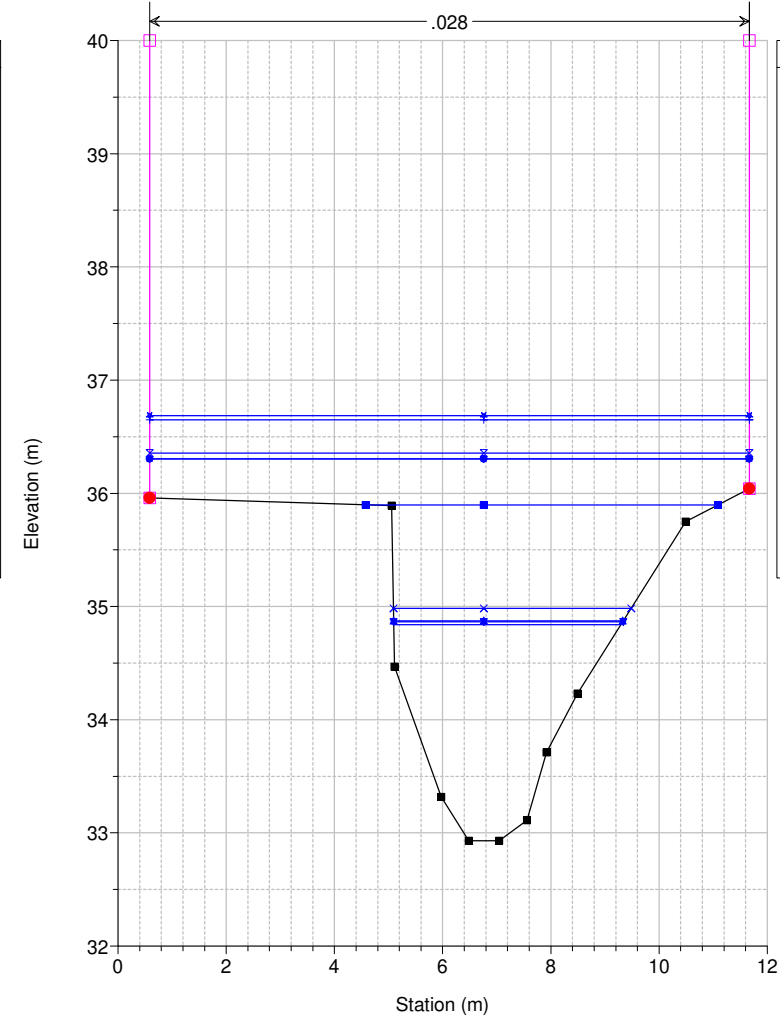

Legend	
WS Max WS - TR200_24_0	+
WS Max WS - TR200_18_0	+
WS Max WS - TR200_12_0	x
WS Max WS - TR200_09_0	•
WS Max WS - TR200_09_0	•
WS Max WS - TR200_36_0	■
WS Max WS - TR200_06_0	■
WS Max WS - TR200_06_0	■
WS Max WS - TR200_03_0	x
WS Max WS - TR200_01_5	▼
WS Max WS - TR200_01_0	▲
WS Max WS - TR200_00_5	■
Ground	■
Levee	□
Bank Sta	•

Studio Scandicci Torrenti Greve-Vingone
River = Fosso Stagnolo Reach = Stagnolo RS = 14 ST0057_B

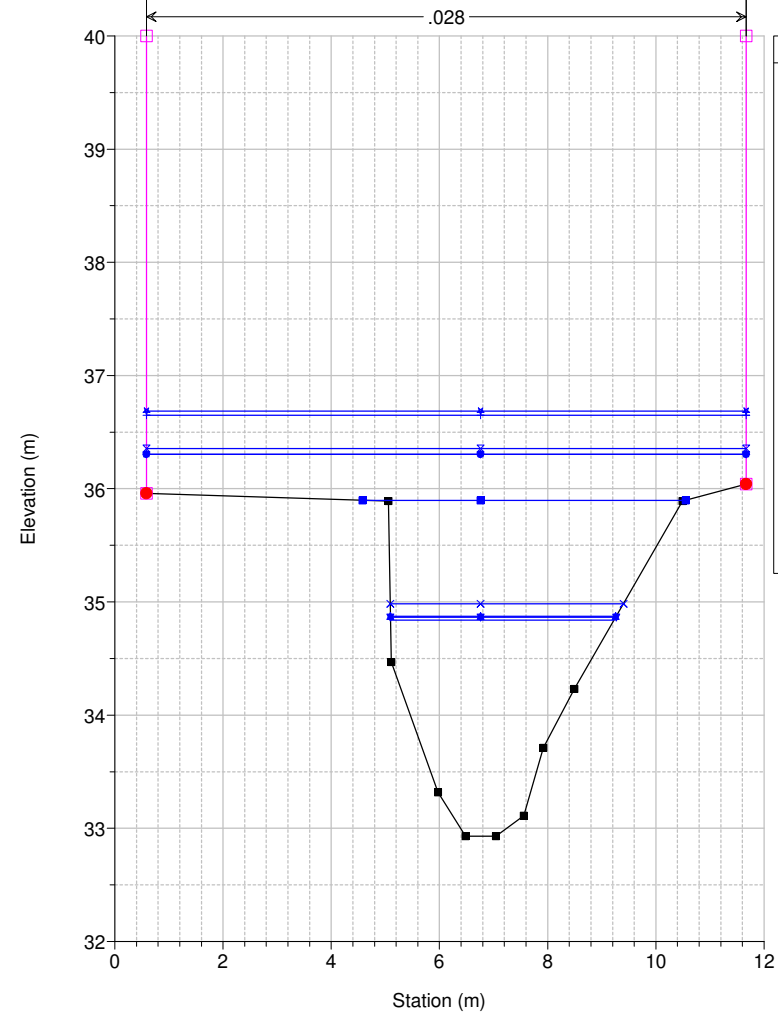

Legend	
WS Max WS - TR200_24_0	+
WS Max WS - TR200_18_0	+
WS Max WS - TR200_12_0	x
WS Max WS - TR200_09_0	•
WS Max WS - TR200_36_0	•
WS Max WS - TR200_06_0	■
WS Max WS - TR200_06_0	■
WS Max WS - TR200_03_0	x
WS Max WS - TR200_01_5	▼
WS Max WS - TR200_01_0	▲
WS Max WS - TR200_00_5	■
Ground	■
Levee	□
Bank Sta	•

Studio Scandicci Torrenti Greve-Vingone
River = Fosso Stagnolo Reach = Stagnolo RS = 13.5 BR

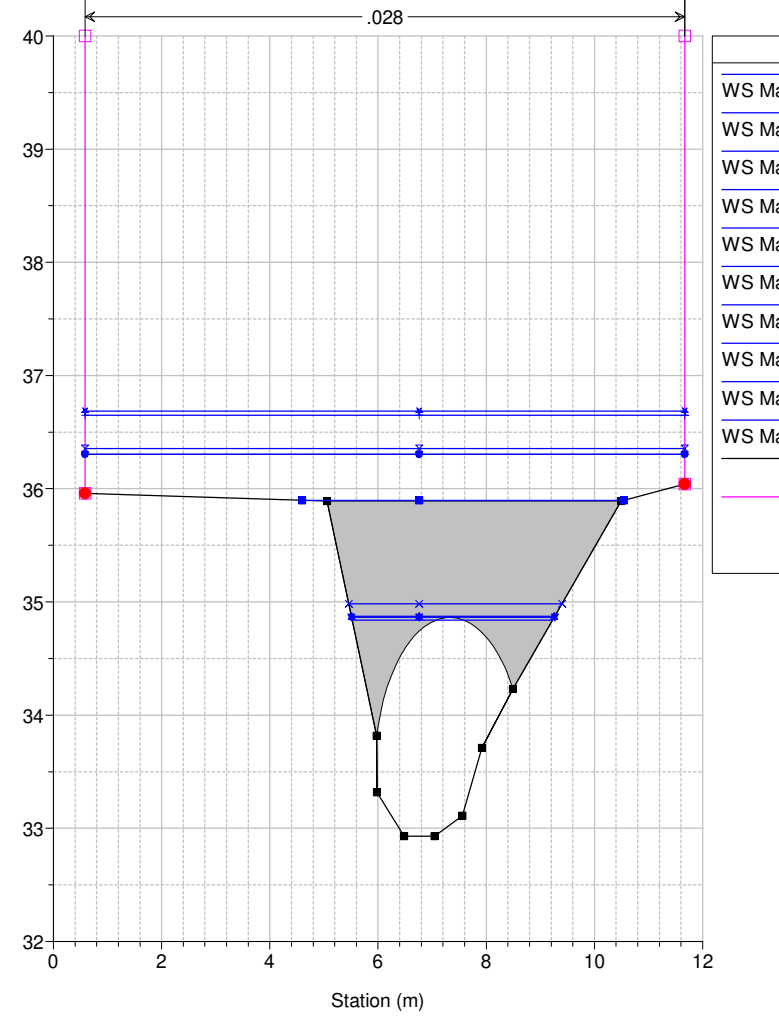

Legend	
WS Max WS - TR200_24_0	+
WS Max WS - TR200_18_0	+
WS Max WS - TR200_12_0	x
WS Max WS - TR200_09_0	•
WS Max WS - TR200_36_0	•
WS Max WS - TR200_06_0	■
WS Max WS - TR200_06_0	■
WS Max WS - TR200_03_0	x
WS Max WS - TR200_01_5	▼
WS Max WS - TR200_01_0	▲
WS Max WS - TR200_00_5	■
Ground	■
Levee	□
Bank Sta	•

Studio Scandicci Torrenti Greve-Vingone
River = Fosso Stagnolo Reach = Stagnolo RS = 13.5 BR

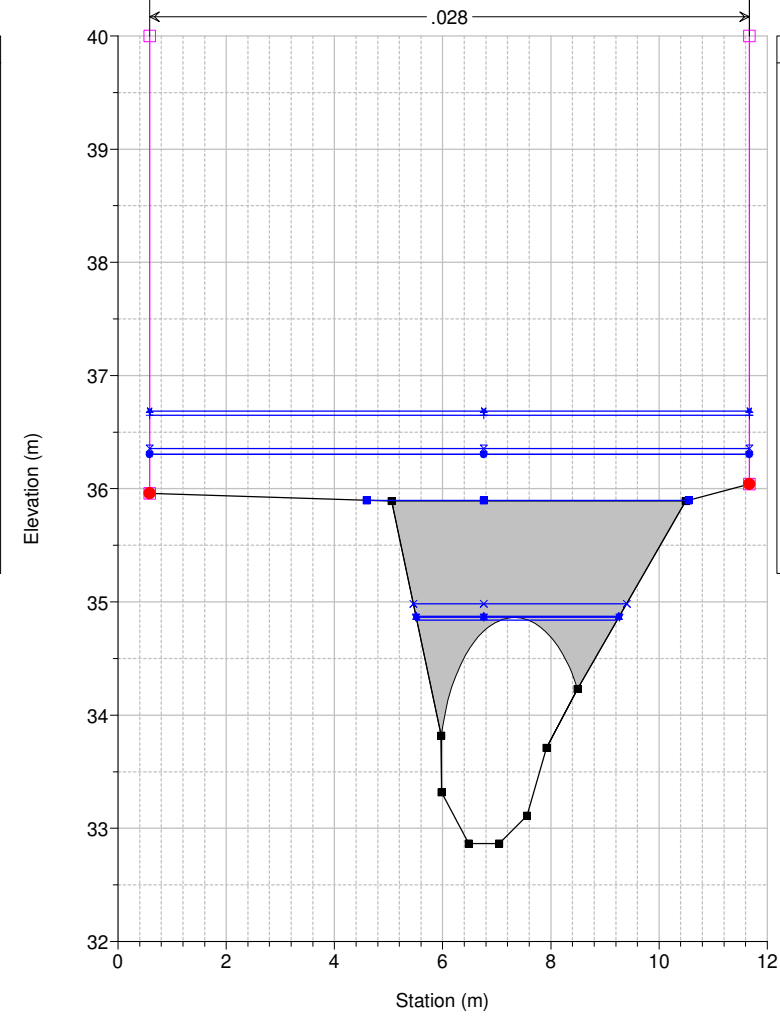

Legend	
WS Max WS - TR200_24_0	+
WS Max WS - TR200_18_0	+
WS Max WS - TR200_12_0	x
WS Max WS - TR200_09_0	•
WS Max WS - TR200_36_0	•
WS Max WS - TR200_06_0	■
WS Max WS - TR200_06_0	■
WS Max WS - TR200_03_0	x
WS Max WS - TR200_01_5	▼
WS Max WS - TR200_01_0	▲
WS Max WS - TR200_00_5	■
Ground	■
Levee	□
Bank Sta	•

Studio Scandicci Torrenti Greve-Vingone
River = Fosso Stagnolo Reach = Stagnolo RS = 13 ST0057_C

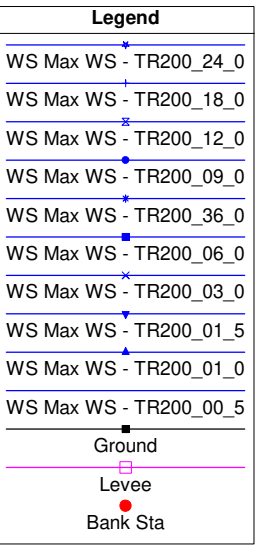
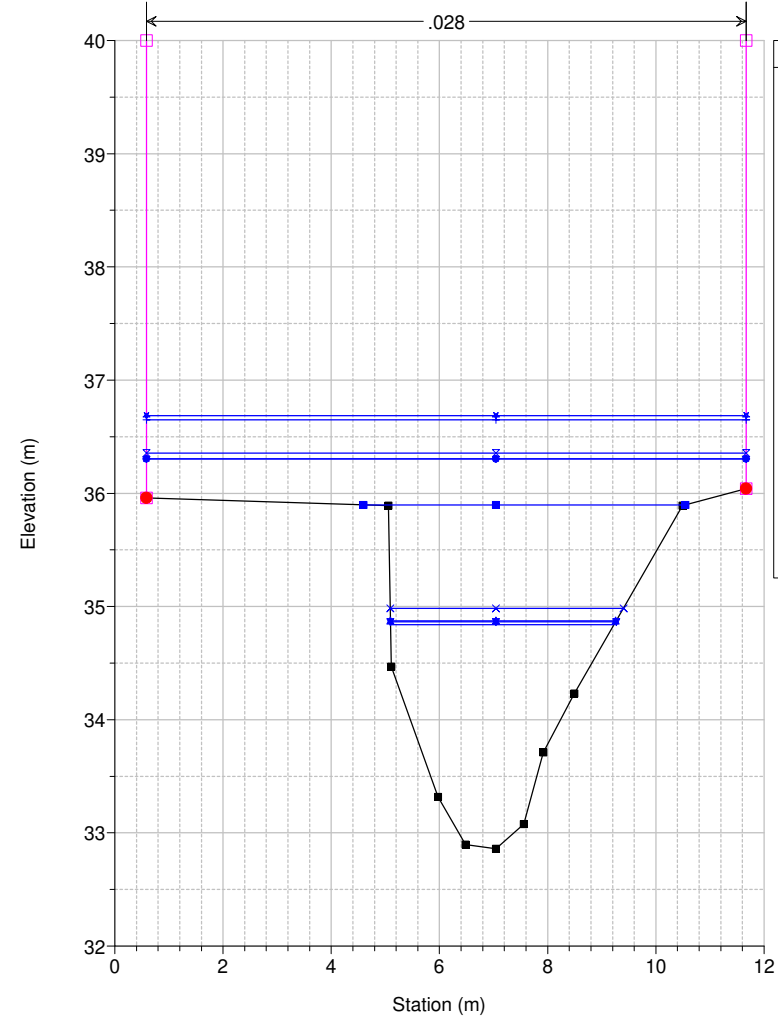

Studio Scandicci Torrenti Greve-Vingone
River = Fosso Stagnolo Reach = Stagnolo RS = 12 ST0057_D

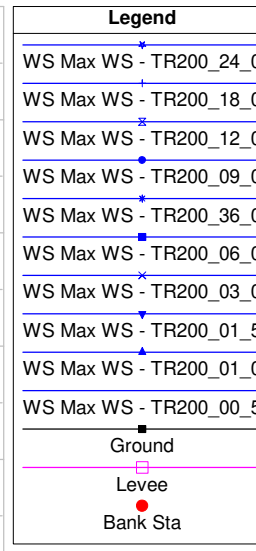
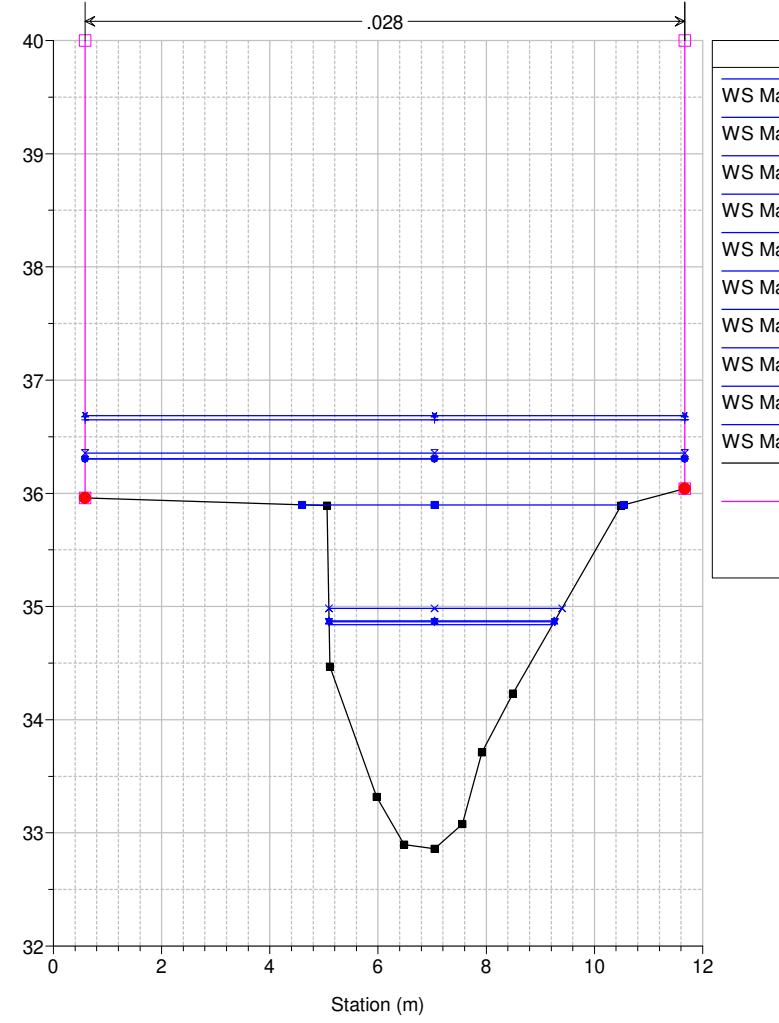

Studio Scandicci Torrenti Greve-Vingone
River = Fosso Stagnolo Reach = Stagnolo RS = 11 ST0058__

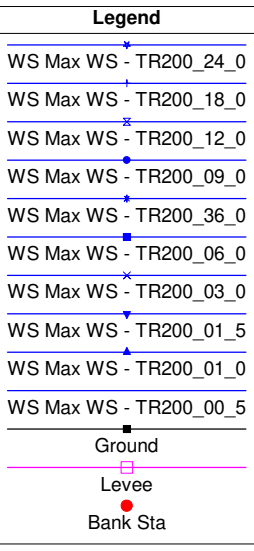
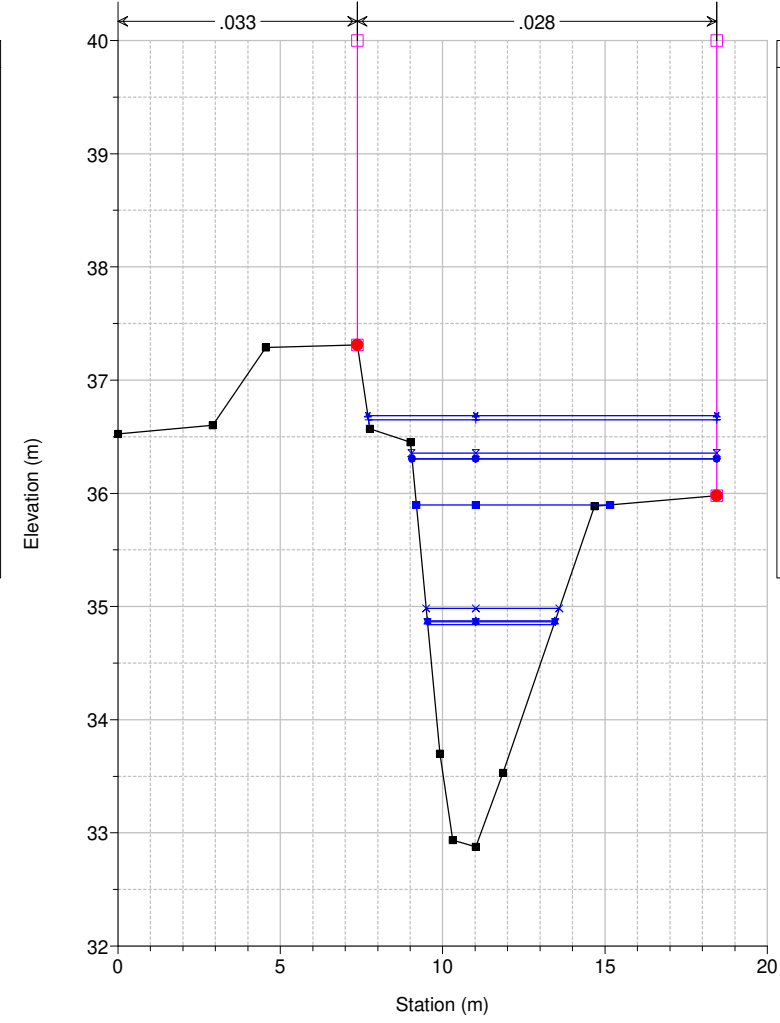

Studio Scandicci Torrenti Greve-Vingone
River = Fosso Stagnolo Reach = Stagnolo RS = 10 ST0059__

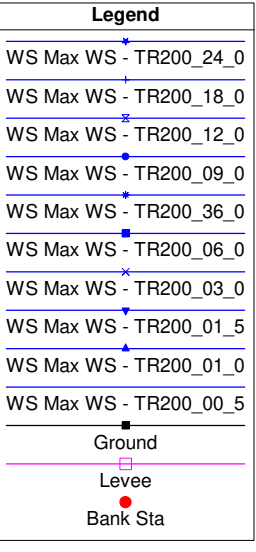
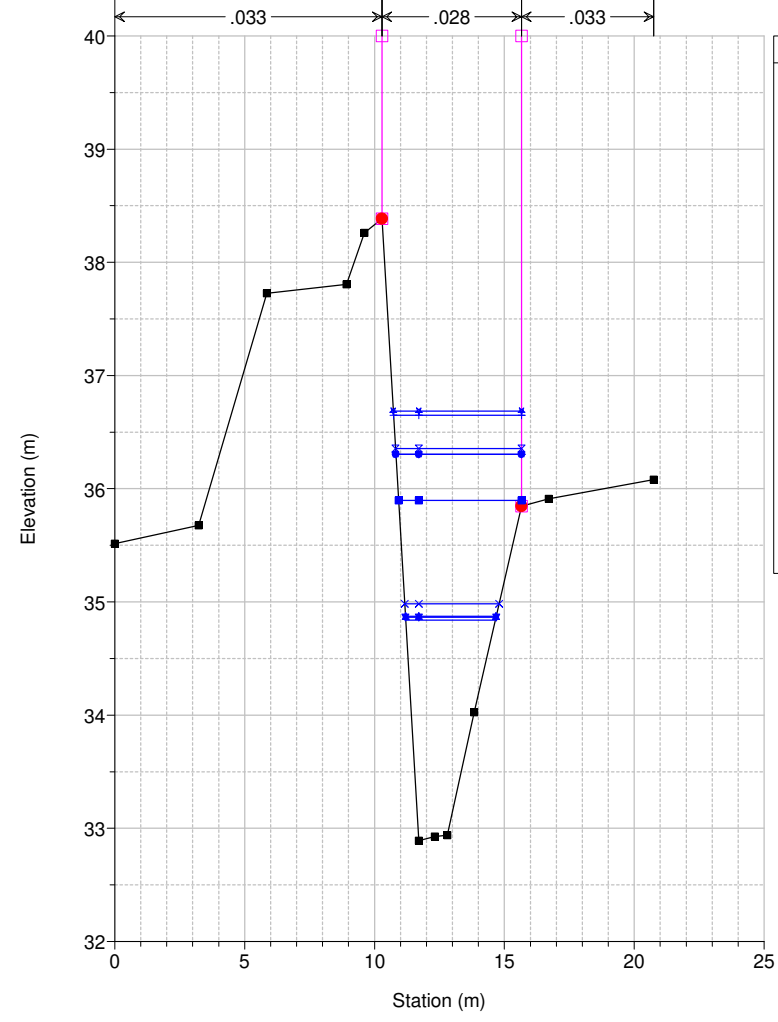

Studio Scandicci Torrenti Greve-Vingone
River = Fosso Stagnolo Reach = Stagnolo RS = 9 ST0060_A

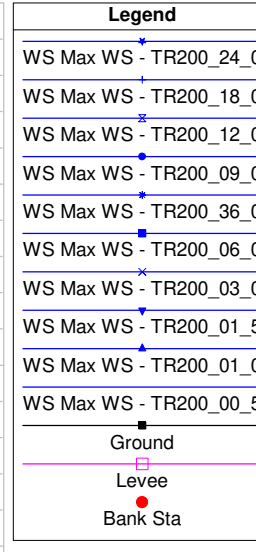
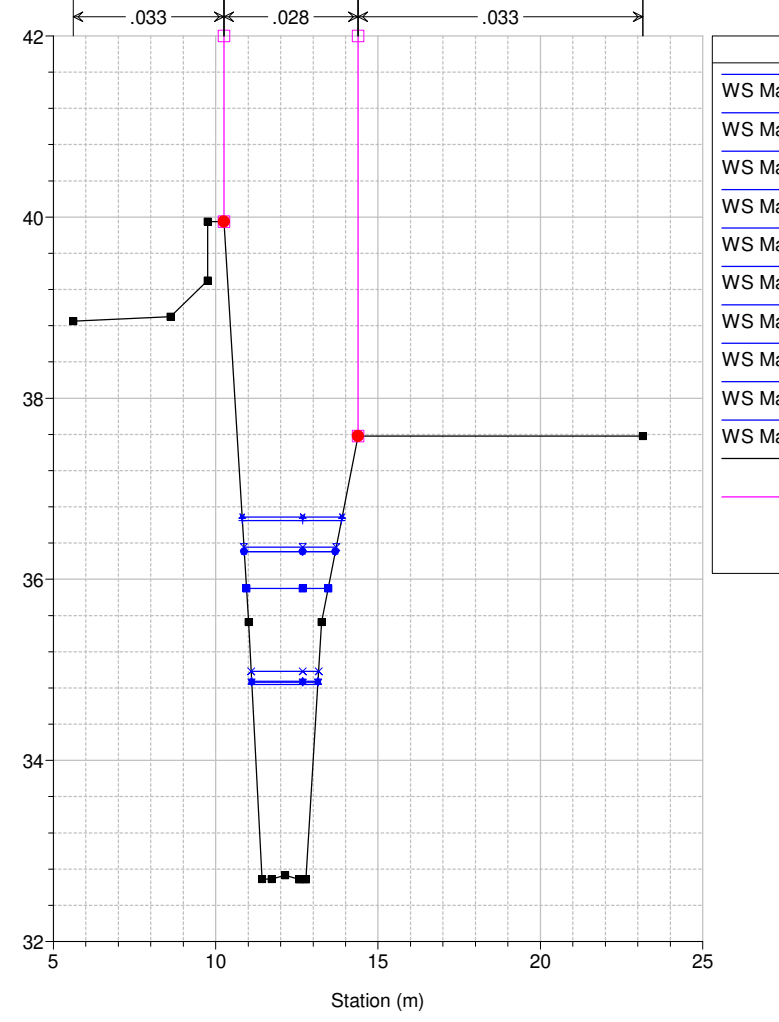

Studio Scandicci Torrenti Greve-Vingone
River = Fosso Stagnolo Reach = Stagnolo RS = 8 ST0060_B

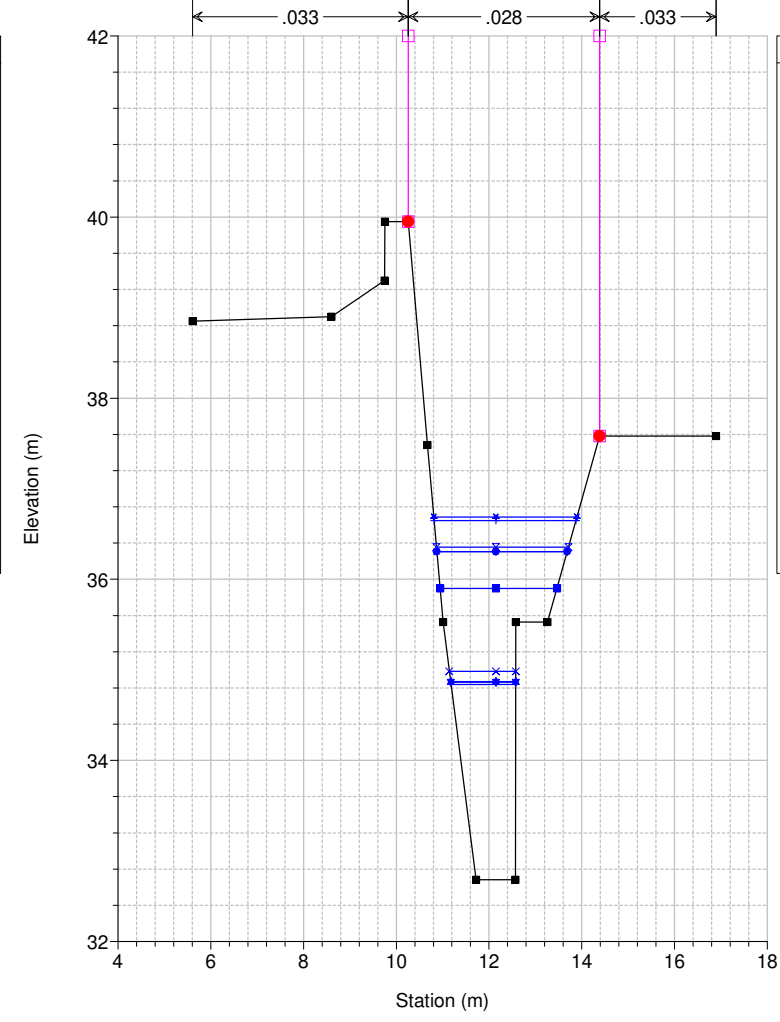

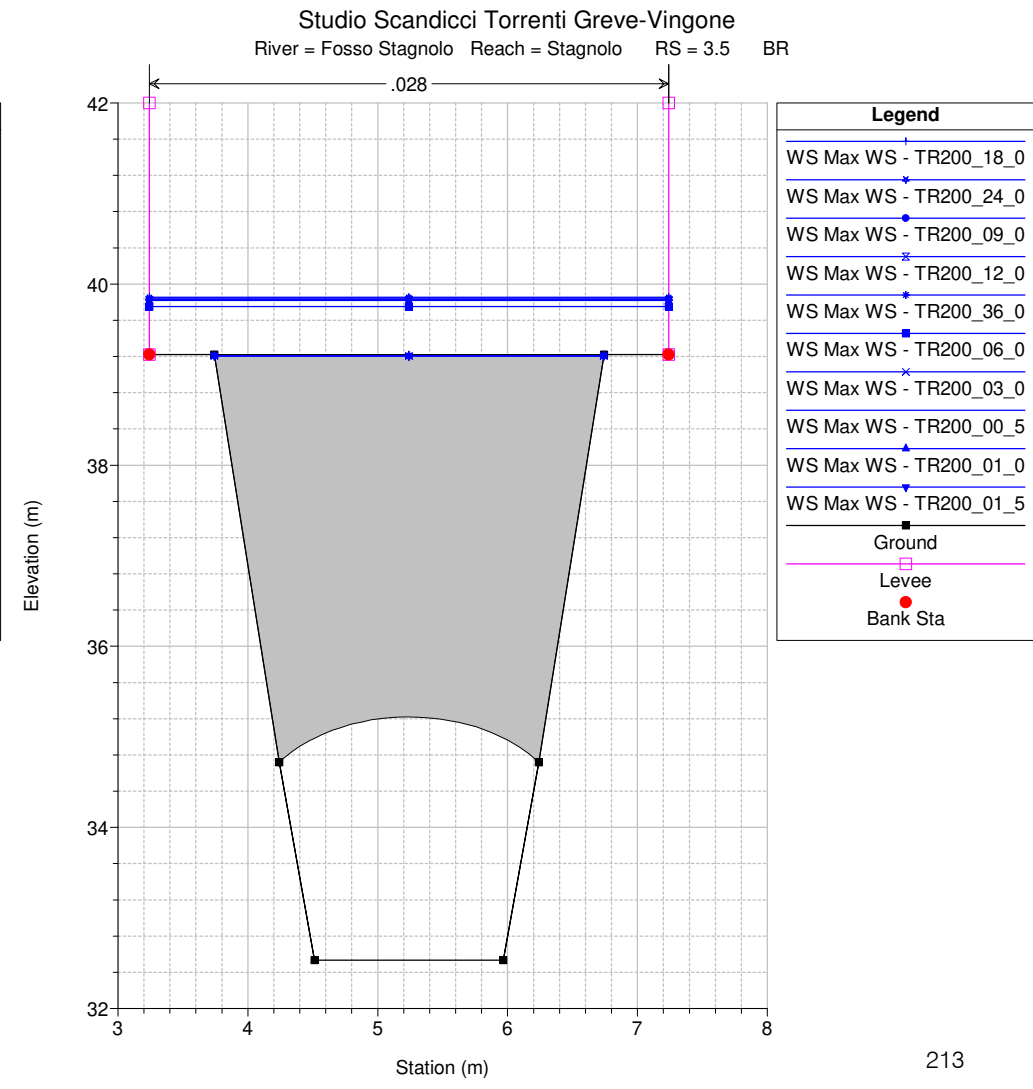
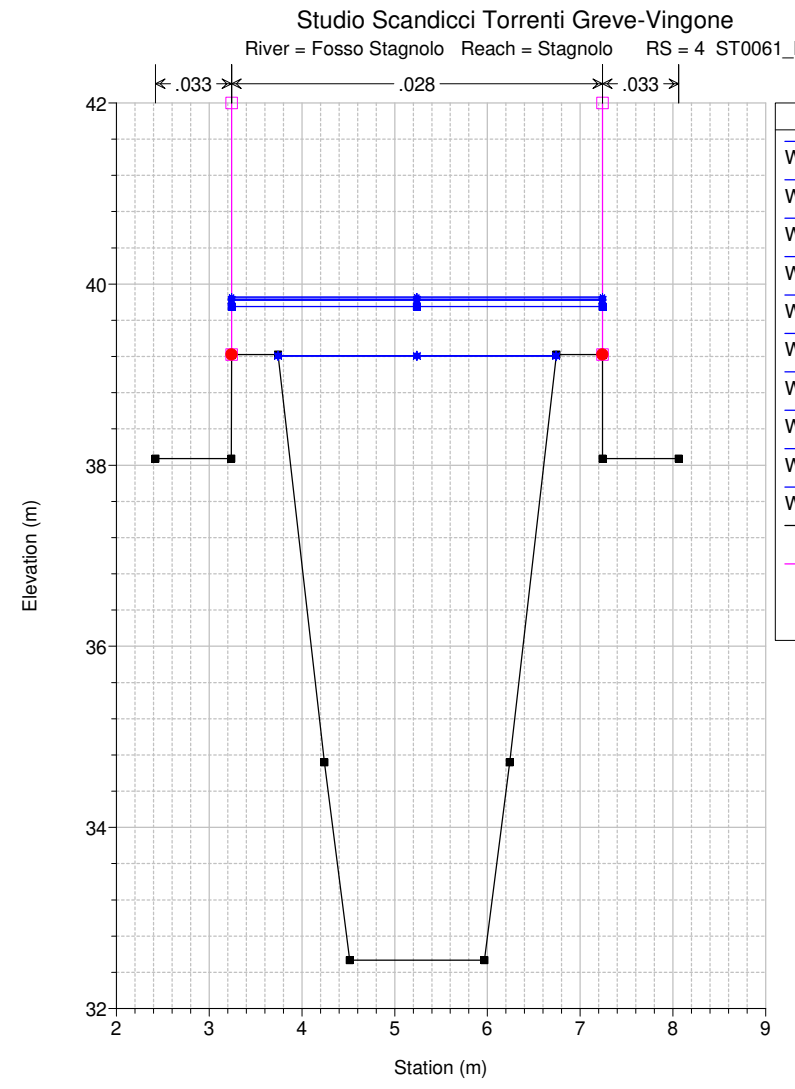
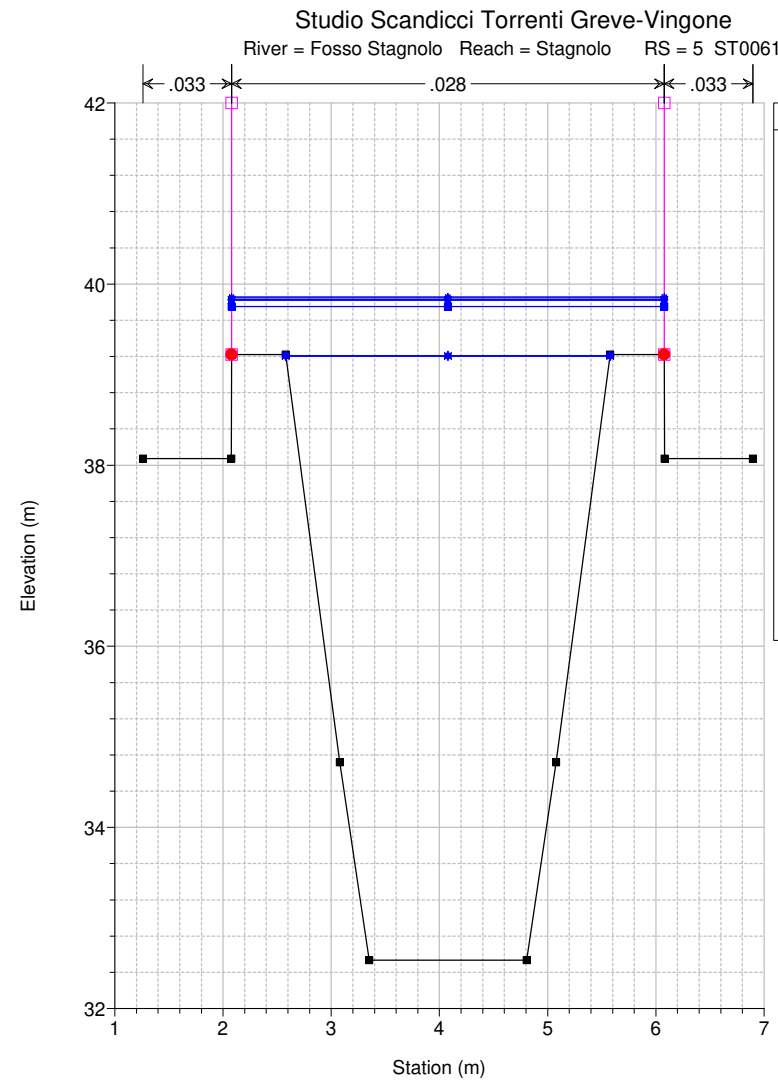
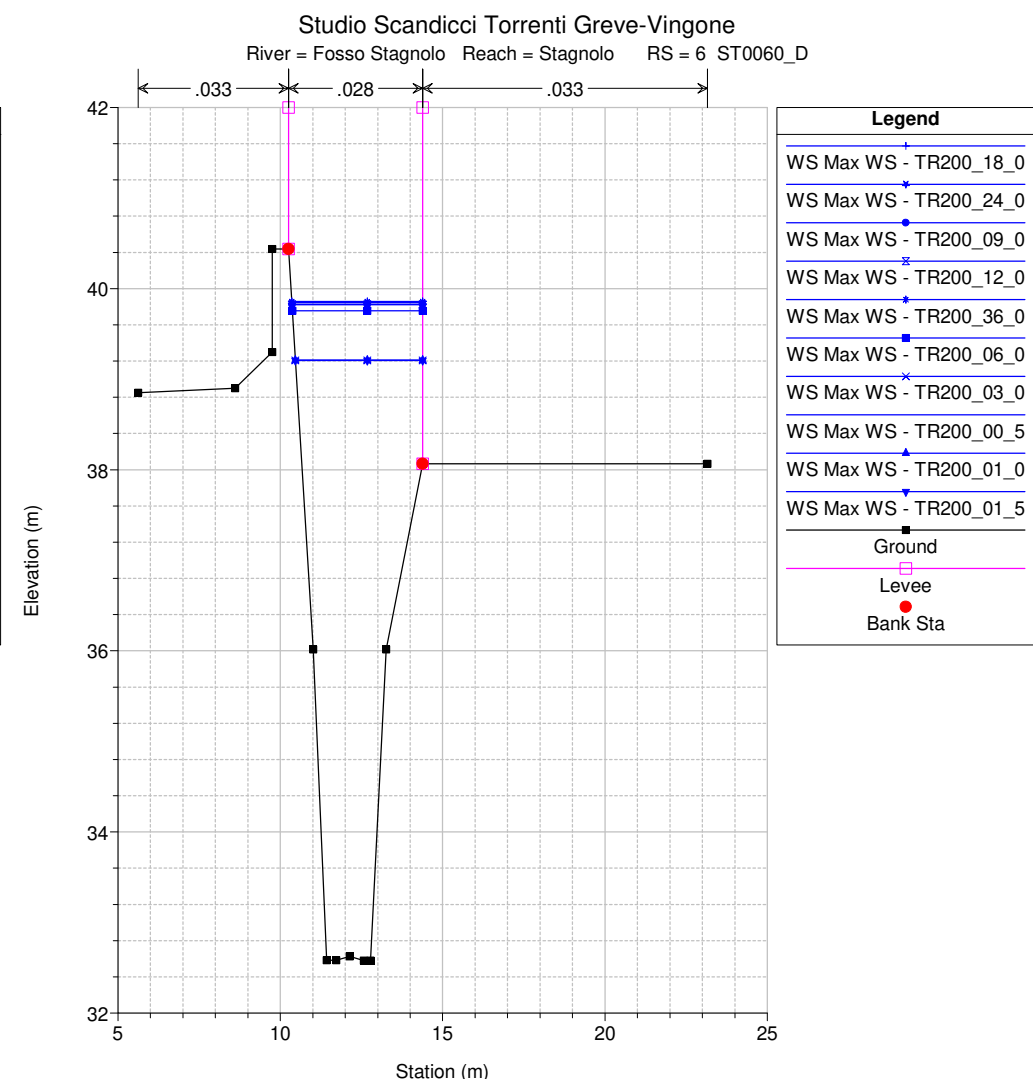
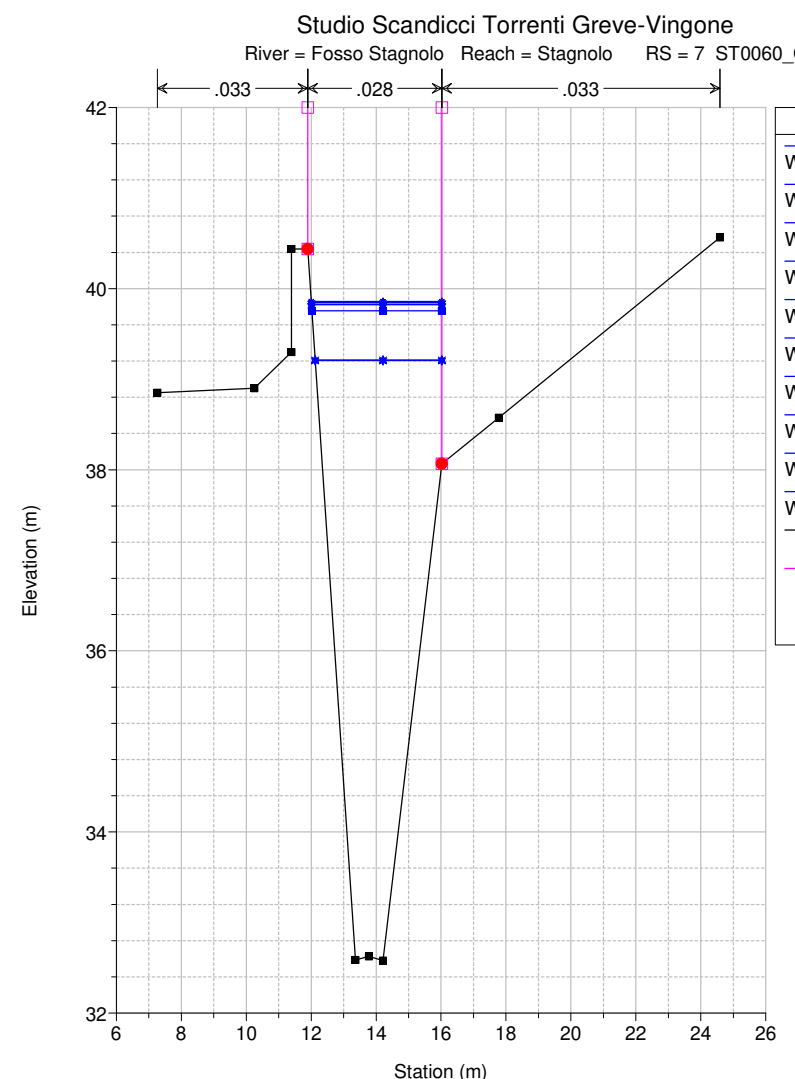
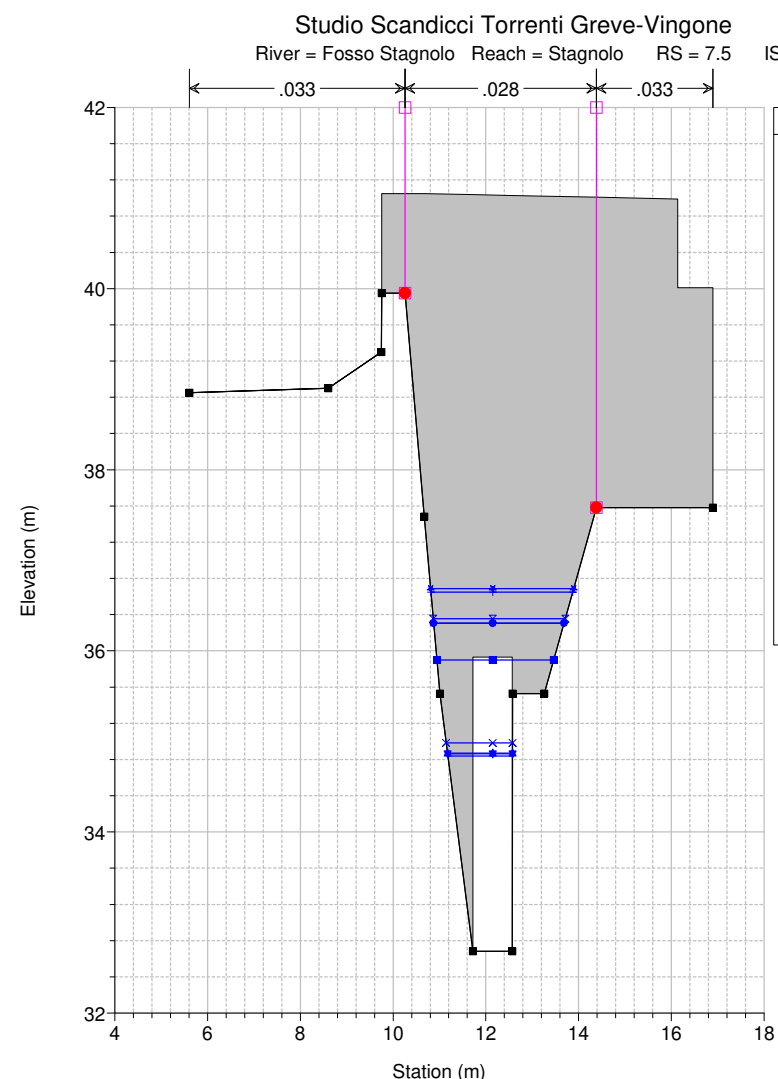

Studio Scandicci Torrenti Greve-Vingone
River = Fosso Stagnolo Reach = Stagnolo RS = 3.5 BR

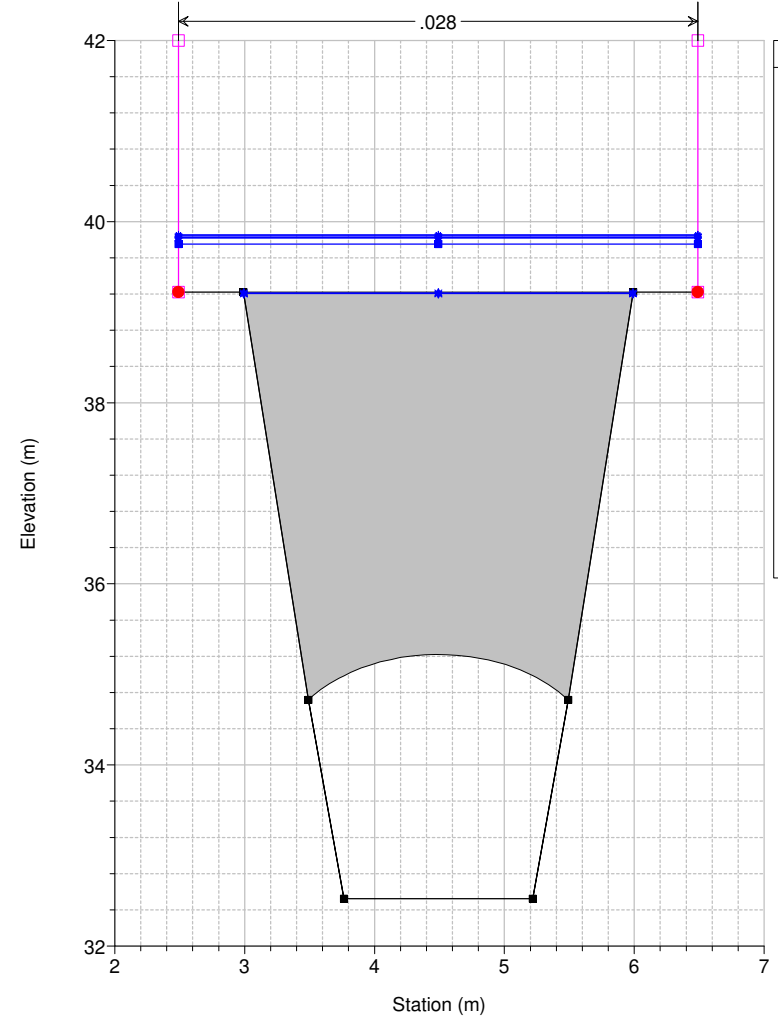

Legend	
WS Max WS - TR200_18_0	+
WS Max WS - TR200_24_0	*
WS Max WS - TR200_09_0	•
WS Max WS - TR200_12_0	x
WS Max WS - TR200_36_0	■
WS Max WS - TR200_06_0	■
WS Max WS - TR200_03_0	x
WS Max WS - TR200_00_5	▲
WS Max WS - TR200_01_0	▲
WS Max WS - TR200_01_5	▼
Ground	■
Levee	□
Bank Sta	•

Studio Scandicci Torrenti Greve-Vingone
River = Fosso Stagnolo Reach = Stagnolo RS = 3 ST0061_C

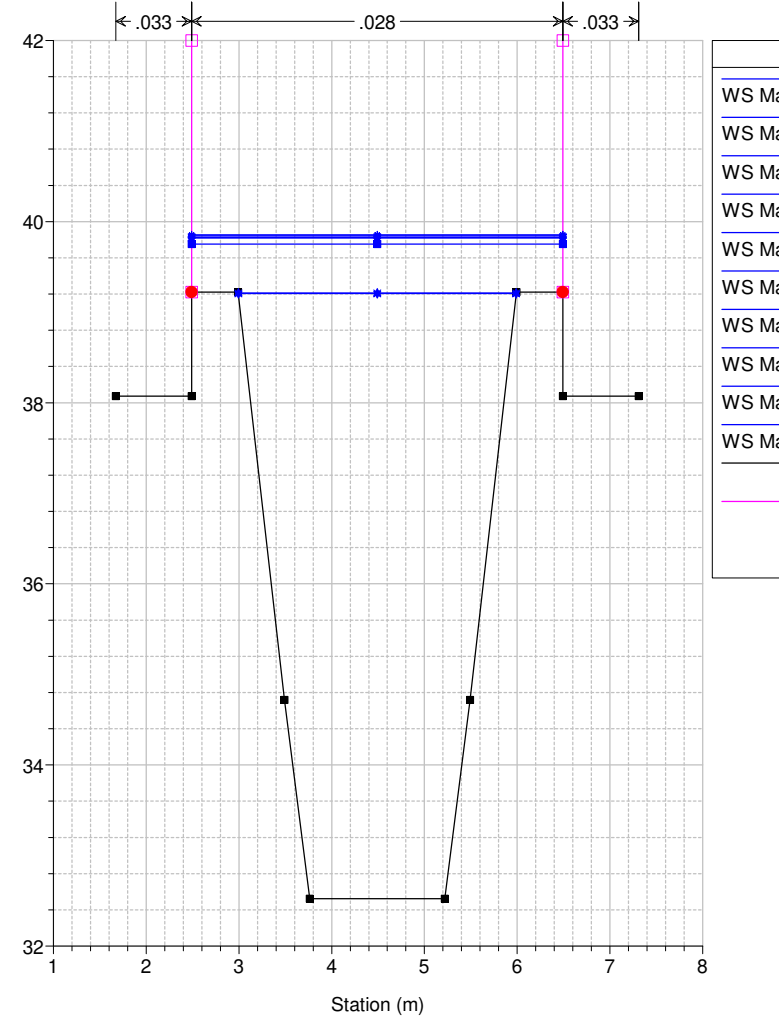

Legend	
WS Max WS - TR200_18_0	+
WS Max WS - TR200_24_0	*
WS Max WS - TR200_09_0	•
WS Max WS - TR200_12_0	x
WS Max WS - TR200_36_0	■
WS Max WS - TR200_06_0	■
WS Max WS - TR200_03_0	x
WS Max WS - TR200_00_5	▲
WS Max WS - TR200_01_0	▲
WS Max WS - TR200_01_5	▼
Ground	■
Levee	□
Bank Sta	•

Studio Scandicci Torrenti Greve-Vingone
River = Fosso Stagnolo Reach = Stagnolo RS = 2 ST0061_D

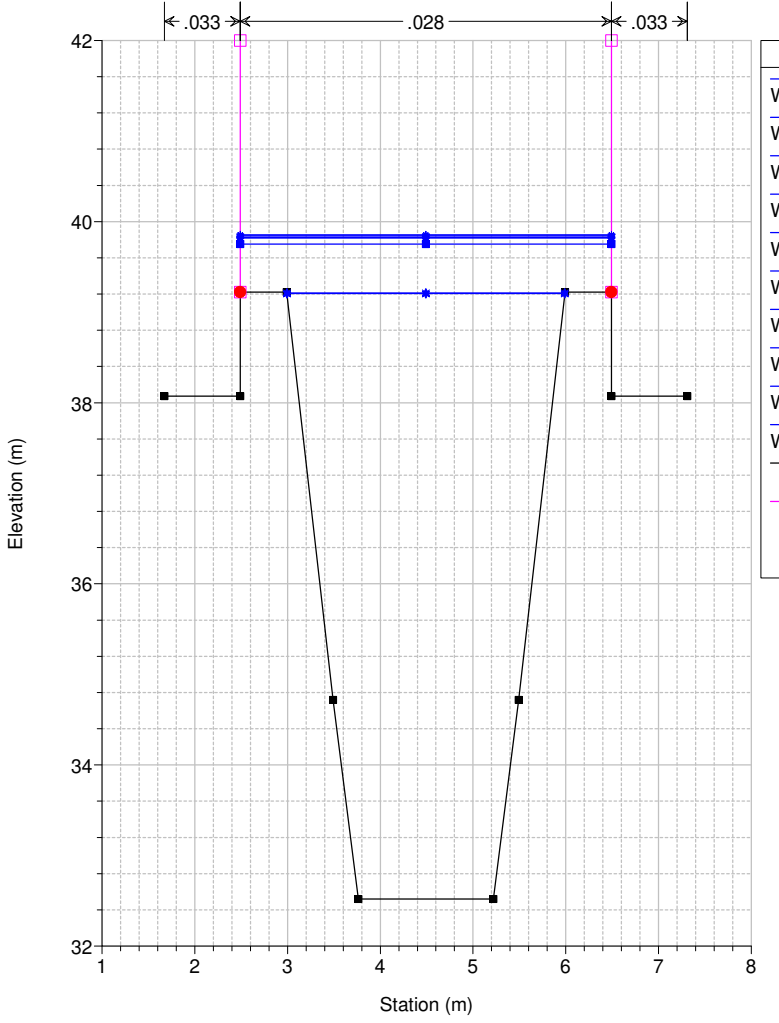

Legend	
WS Max WS - TR200_18_0	+
WS Max WS - TR200_24_0	*
WS Max WS - TR200_09_0	•
WS Max WS - TR200_12_0	x
WS Max WS - TR200_36_0	■
WS Max WS - TR200_06_0	■
WS Max WS - TR200_03_0	x
WS Max WS - TR200_00_5	▲
WS Max WS - TR200_01_0	▲
WS Max WS - TR200_01_5	▼
Ground	■
Levee	□
Bank Sta	•

Studio Scandicci Torrenti Greve-Vingone
River = Fosso Stagnolo Reach = Stagnolo RS = 1 ST0062_

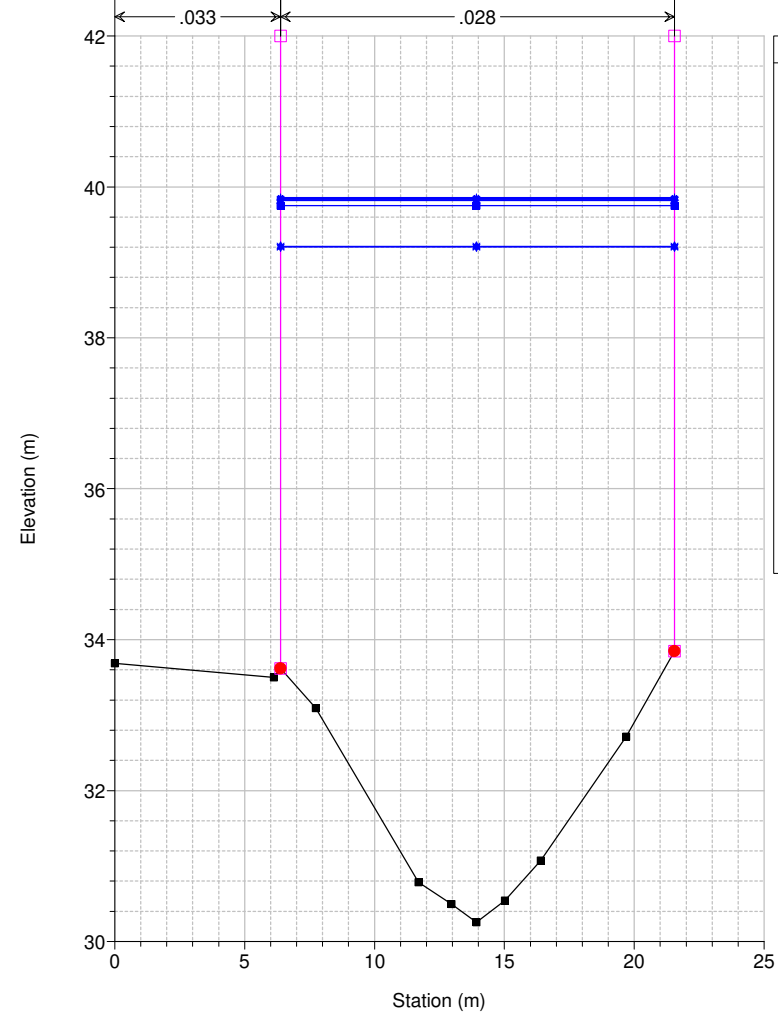

Legend	
WS Max WS - TR200_18_0	+
WS Max WS - TR200_24_0	*
WS Max WS - TR200_09_0	•
WS Max WS - TR200_12_0	x
WS Max WS - TR200_36_0	■
WS Max WS - TR200_06_0	■
WS Max WS - TR200_03_0	x
WS Max WS - TR200_00_5	▲
WS Max WS - TR200_01_0	▲
WS Max WS - TR200_01_5	▼
Ground	■
Levee	□
Bank Sta	•

Studio Scandicci Torrenti Greve-Vingone
River = Fosso Stagnolo Reach = Stagnolo RS = 0.5 AR0517

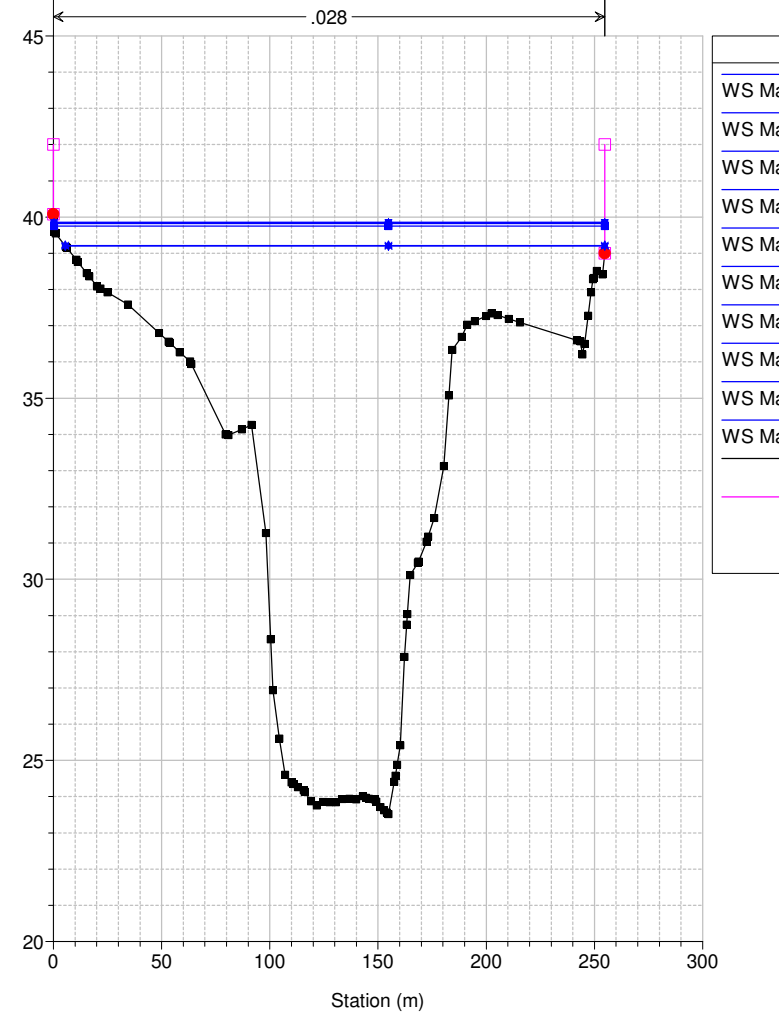

Legend	
WS Max WS - TR200_18_0	+
WS Max WS - TR200_24_0	*
WS Max WS - TR200_09_0	•
WS Max WS - TR200_12_0	x
WS Max WS - TR200_36_0	■
WS Max WS - TR200_06_0	■
WS Max WS - TR200_03_0	x
WS Max WS - TR200_00_5	▲
WS Max WS - TR200_01_0	▲
WS Max WS - TR200_01_5	▼
Ground	■
Levee	□
Bank Sta	•